

# LANDSCAPE MANAGEMENT

SERVING GOLF AND LANDSCAPE PROFESSIONALS

## Subscription Fax

# free

Complete this form today and fax it to:  
218-723-9433

I wish to receive (continue receiving) LANDSCAPE MANAGEMENT free of charge:

YES  no

Signature \_\_\_\_\_ Date \_\_\_\_\_

Name (please print) \_\_\_\_\_

Title \_\_\_\_\_ Phone No. (\_\_\_\_) \_\_\_\_\_

Your Firm's Name \_\_\_\_\_

Business Address \_\_\_\_\_

City \_\_\_\_\_ State \_\_\_\_\_ Zip \_\_\_\_\_

Do you wish to receive promotional materials? YES  NO

### 1. BUSINESS & INDUSTRY

My primary business at this location is: (Check only one in either A, B, or C)

#### A. LANDSCAPE/GROUND CARE AT ONE OF THE FOLLOWING TYPES OF FACILITIES:

- |   |  |
|---|--|
| 0005 <input type="checkbox"/> Golf courses  | 0050 <input type="checkbox"/> Cemeteries/memorial gardens              |
| 0010 <input type="checkbox"/> Sports complexes  | 0060 <input type="checkbox"/> Military installations & prisons         |
| 0015 <input type="checkbox"/> Parks   | 0065 <input type="checkbox"/> Airports                                 |
| 0020 <input type="checkbox"/> Rights-of-way maintenance for highways, railroads & utilities | 0070 <input type="checkbox"/> Multiple government municipal facilities |
| 0025 <input type="checkbox"/> Schools, colleges & universities                              | <input type="checkbox"/> Other type of facility (specify) _____        |
| 0030 <input type="checkbox"/> Industrial & office parks/plants                              | _____  |
| 0045 <input type="checkbox"/> Condominiums/apartments/housing developments/hotels/resorts   | _____  |

#### B. CONTRACTORS/SERVICE COMPANIES/CONSULTANTS:

- |  |   |
|--|---|
| 0105 <input type="checkbox"/> Landscape contractors (Installation & maintenance) | 0135 <input type="checkbox"/> Extension agents/consultants for horticulture |
| 0110 <input type="checkbox"/> Lawn care service companies                        | <input type="checkbox"/> Other contractor or service (specify) _____        |
| 0112 <input type="checkbox"/> Custom chemical applicators                        | _____   |
| 0125 <input type="checkbox"/> Landscape architects                               | _____   |

#### C. SUPPLIERS

- |   |   |
|---|---|
| 0205 <input type="checkbox"/> Sod growers           | <input type="checkbox"/> Other supplier (specify) _____ |
| 0210 <input type="checkbox"/> Dealers, distributors | _____   |

### 2. WHICH OF THE FOLLOWING BEST DESCRIBES YOUR TITLE? (Check only one)

- 10  EXECUTIVE/ADMINISTRATOR—President, owner, partner, director, general manager, chairman of the board, purchasing agent, director of physical plant
- 20  MANAGER/SUPERINTENDENT—Landscape/ground manager, superintendent, foreman, supervisor
- 30  GOVERNMENT OFFICIAL—Government commissioner, agent, other government official
- 40  SPECIALIST—Arborist, forester, architect, consultant, agronomist, pilot, instructor, researcher, horticulturalist, certified specialist
- 50  OTHER TITLED AND NON-TITLED PERSONNEL (specify) \_\_\_\_\_



# PRODUCTS

## New fertilizer more organically based

Humax Corporation has developed an organically-based line of fertilizers for lawns, gardens, golf courses, parks and other settings.

Humax, based in Salt Lake City, Utah, uses a patented colloidal process that efficiently uses nitrogen, phosphate and potassium and combines these nutrients with organic material present in the soil.

The firm says nutrient leaching is

lessened and a reactor process breaks down organic waste within a matter of minutes into humic acid. The company says plant root systems' feeding capacity is increased through use of the fertilizer.

Circle No. 190 on Reader Inquiry Card.

## Spreader carrier simplifies portal to portal transport

External Spreader Carriers of Little

Rock, Ark., has designed a spreader carrier to fit most common broadcast type equipment.

The carrier, developed to avoid interior fertilizer spills from spreaders while in transport, comes with two adapters to accommodate LESCO, Spyker and Ev-N-Spred models and other popular designs. The device is affixed to the rear bumper of the service vehicle. It is easily installed and more than 200 pounds. The unit weighs 21 pounds.



Circle 191 on Reader Inquiry Card

## Ornamental herbicide controls grass growth

BASF Corporation announced registration with the EPA of Vantage, a new herbicide for control of annual and perennial grasses in nurseries, ornamentals, ground covers, Christmas trees and general indoor and outdoor sites.



Vantage can be used on control of seedling johnsongrass, smooth crabgrass, seedling tall fescue and goosegrass as well as perennials as bermudagrass, rhizome johnsongrass and quackgrass.

A California label for Vantage is pending.

Vantage enters the grass through foilage. Growth slows and stops

**TURF • TYPE**  
**OREGON TALL FESCUE**  
SEED FROM OREGON

**Beautiful or Functional**

Have them both! Rich, green Turf Type Tall Fescue gives you the beauty you want with a minimum of care.

Excellent for lawns, play areas, parks, airfields, roadways, golf courses and industrial sites.

Proven disease resistant, Oregon Grown Tall Fescue seed produces an adaptable, weed free turf that not only persists through summers and winters, but maintains its beauty.

Insist on Turf Type Tall Fescue seed grown in Oregon.

For more information contact your seed dealer, or write to:  
**OREGON TALL FESCUE COMMISSION**  
866 Lancaster Dr. SE, Salem, Oregon 97301  
Phone: (503) 585-1157

Circle No. 128 on Reader Inquiry Card



# If You Knew How Little it Costs To Buy & Run a National You Wouldn't Buy any Other Triplex!

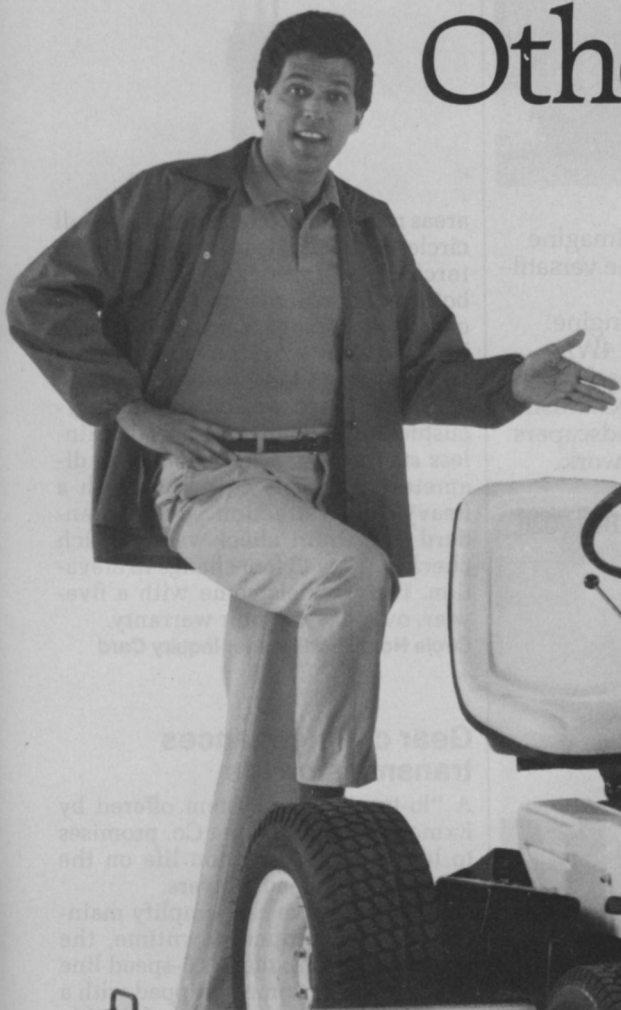

Before you make a final purchase,  
check the true value National  
Mowers offer. Call today for a FREE video.

(612) 646-4079



**NATIONAL MOWER COMPANY**

SINCE 1919

700 Raymond Avenue  
St Paul, Minnesota 55114  
FAX (612) 646-2887

# B20: SPACE SAVING STAMINA



Kubota's first-of-a-kind B-20 diesel tractor may surprise you. Imagine the power and performance of a Tractor/Loader/Backhoe with the versatility to maneuver in small spaces!

The B-20 is powered by a Kubota 20 HP liquid-cooled diesel engine. Hydrostatic transmission, integral power steering, and standard 4WD make the B-20 easy to move around a job site. The quick attach backhoe is driven hydraulically and includes an automatic return-to-dig mechanism.

The durable B-20 meets the needs of building contractors, landscapers and others who perform loader, backhoe and light construction work. This compact Kubota will give you full size performance.

For more information, write to Kubota Tractor Corporation, P.O. Box 7020, Compton, California 90224-7020.



Kubota assures top quality by designing and manufacturing all key components.

## Kubota®

Circle No. 115 on Reader Inquiry Card

within two days, the company says, and the plant reddens, its leaf tips burn and burn back of the foliage follows.

Circle No. 192 on Reader Inquiry Card

### Adjustable arc sprinkler to cover lots of space

The I-40-ADS arc sprinkler by Hunter Industries is now available in two models.

The units may be set between 40 and 360 degrees while water is on or off. Model I-40-36S is also available for



areas requiring a fixed 360 degree full circle. Both models come with five interchangeable nozzles which vary both radius and discharge rates. Discharge rates range from 7 to 25.3 gallons per minute and the radius may be varied from 45 to 67 feet.

Other features include safety-cushioned rubber covers and stainless steel risers. A 1 5/8 exposed diameter surface is equipped with a heavy-duty retraction spring. Standard is a drain check valve which checks up to a 15 foot change in elevation. Both models come with a five-year, over-the-counter warranty.

Circle No. 193 on Reader Inquiry Card

### Gear drive enhances transmission life

A "lo-torq" drive system offered by Exmark Manufacturing Co. promises to lengthen transmission life on the company's 5-speed mowers.

The gear drive can simplify maintenance and reduce downtime, the company says. Exmark's 5-speed line of mowers also come equipped with a posi-track pulley system and double idlers on wheel drive belts.

Exmark says these features provide for maximum maneuverability and prevent downhill runaway.

Circle No. 194 on Reader Inquiry Card

### Safety feature offered for Ransomes midders

Ransomes Inc. announced recently that all Bob-Cat mid-size mowers

# Troubled waters?

## Otterbine Aerators

The prescription for troubled breathing, poor circulation, and changing temperatures in ponds and lakes is practical engineering that is esthetically pleasing.

These aerators range in power, circulating from 600,000 to 20 million gallons of water in a

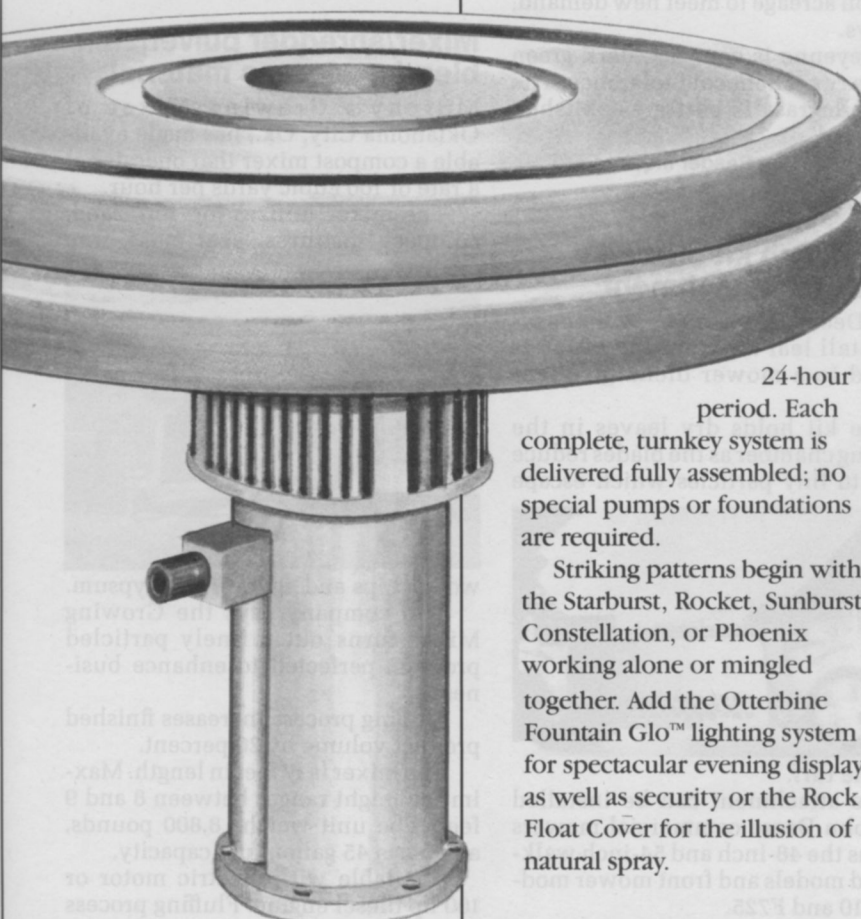
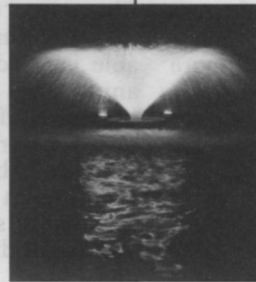

24-hour period. Each complete, turnkey system is delivered fully assembled; no special pumps or foundations are required.

Striking patterns begin with the Starburst, Rocket, Sunburst, Constellation, or Phoenix working alone or mingled together. Add the Otterbine Fountain Glo™ lighting system for spectacular evening display as well as security or the Rock Float Cover for the illusion of natural spray.

Otterbine Aerators meet the water management needs of golf courses, parks, recreational lakes, office developments, and residential condominiums. Call or write for more information:

**Barebo Inc.**  
R.D. 2, P.O. Box 217  
Emmaus, PA 18049

**215/965-6018**



**"See us at GCSAA show,  
Booth No.837-843"**



manufactured before 1989 may be equipped with operator present controls.

The control stops the engine if the mower's blade has been engaged and the operator releases grip on the handle.

Installation of the control is offered at a special price to Bob-Cat owners. Details on conversions are available at authorized Ransomes/Bob-Cat dealers.

**Circle No. 195 on Reader Inquiry Card**

## New herbicide controls bahiagrass as it sprouts

O.M. Scott & Sons Co. has released DMC Weed Control to combat bahiagrass growth in bermudagrass areas.

DMC also fights foxtail and more than 25 broadleaf weeds, including



chickweed, henbit, dandelion, wild garlic, white clover and plantain.

The granular herbicide is applied as a foliar spray and the company can provide application timing a rate flexibility.

**Circle No. 196 on Reader Inquiry Card**

## Three patents granted for plant disease detection

Agri-Diagnostics Associates has been granted three patents for monoclonal antibodies that detect plant diseases.

The inventions can detect Pythiaceae, including several phytophthora and pythium diseases, *Sclerotinia homoeocarpa*, related to dollar spot disease and *rhizoctonia*, causative agent of diseases on turf and other crops.

The antibodies are being used to develop rapid and low cost tests for

diseases in soil and plant tissues. The firm has already marketed REVEAL tissue testings kits used in fungal diseases in turf. Also a soil test for Phytophthora root rot in soybeans is available. In development are soil and tissue Phytophthora tests for apples, peaches, tomatoes, peppers, citrus, avocado and berry crops. Phytophthora, pythium and rhizoctonia development tests are underway in nursery and greenhouse crops and rhizoctonia in rice and cotton.

**Circle No. 197 on Reader Inquiry Card**

## Bermudagrass seed is available in spring

Cheyenne "turf type" Bermudagrass from Pennington Seed will be available in good quantity, the company announced. Production fields at Pennington's affiliate Cactus Seed Company near Roll, Arizona, has delivered the seed as expected. But Pennington vice president Ronnie Stapp says supplies could be somewhat tight due to an expected strong demand.

The firm expects to increase production acreage to meet new demand, he says.

Cheyenne is compact, dark green and has excellent cold tolerance. The Bermudagrass is easily established from seed.

**Circle No. 198 on Reader Inquiry Card**

## Leaf mulch kit offered as mower attachment

John Deere Co. is offering an easy-to-install leaf mulcher kit which is affixed to a mower discharge opening.

The kit holds dry leaves in the mowing chamber as the blades reduce them to tiny particles which escape

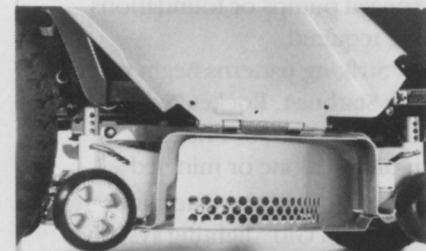

into the turf.

The attachment can be installed into John Deere commercial mowers such as the 48-inch and 54-inch walk-behind models and front mower models F710 and F725.

Leaf debris won't add to thatch build up, according to the company, because leaves are chopped into fine

pieces and break down quickly in the soil.

**Circle No. 199 on Reader Inquiry Card**

## Hydraulic four-wheeler new in Jacobsen line

The Jacobsen Division of Textron's latest addition to Turfcat is the hydraulic four-wheel drive Turfcat T422D.



Each Turfcat can be equipped with a variety of attachments including front-mounted rotary mowing decks, or with fine-cut flail that eliminates grass clipping collection. Snow throwing, straight blade, rotary brush and blower attachments are also available.

**Circle No. 200 on Reader Inquiry Card**

## Mixer/shredder pulverizes, blends, screens material

Murphy's Growing Mixer of Oklahoma City, Ok., has made available a compost mixer that operates at a rate of 100 cubic yards per hour.

The mixer utilizes top soil, sand, compost, manures, peat moss, fine



wood chips and agricultural gypsum.

The company says the Growing Mixer turns out a finely particled product, perfected to enhance business.

Fluffing process increases finished product volume by 20 percent.

The mixer is 17 feet in length. Maximum height ranges between 8 and 9 feet. The unit weighs 8,800 pounds, and has a 45 gallon fuel capacity.

Available with electric motor or 100 hp diesel engine. Fluffing process increases finished product volume by 20 percent.

**Circle No. 201 on Reader Inquiry Card**

# BOOKSTORE

## 410 - DISEASES & PESTS OF ORNAMENTAL PLANTS

by Pascal Pirone

This standard reference discusses diagnosis and treatment of diseases and organisms affecting nearly 500 varieties of ornamental plants grown outdoors, under glass or in the home. Easy to understand explanations of when and how to use the most effective fungicides, insecticides and other control methods. **\$39.95**

## 430 - DISEASES OF TREES AND SHRUBS

By Wayne Sinclair, Howard Lyon and Warren Johnson

A comprehensive pictorial survey of the diseases of, as well as the environmental damage to, forest and shade trees and woody ornamental plants in the United States and Canada. Reflects the most important developments in fungal biology and taxonomy, plant bacteriology, virology, and environmentally induced stress in plants. Summarizes information about newly discovered diseases and provides up-to-date accounts of old ones. **\$52.50**

## 800 - THE GOLF COURSE

by Cornish and Whitten

The first book ever to give the art of golf course design its due, and golf course architects the credit and recognition they deserve. 320 pages and 150 color and black and white photographs. Traces the history and evolution of the golf course, analyzes the great courses, shows how they were designed and constructed. **\$35.00**

## 420 - HERBICIDE INJURY TO TREES AND SHRUBS

By Jeffrey F. Derr and Bonnie Lee Appleton

Describes how to diagnose herbicide damage to nursery crops and landscape ornamentals. Injury symptoms resulting from the herbicides used today are described and compared to other plant disorders to assist in diagnosing plant problems. Tables list common names, trade names, major uses and injury symptoms for the herbicides currently used in agronomic, horticultural, landscape and noncrop areas. **\$24.95**

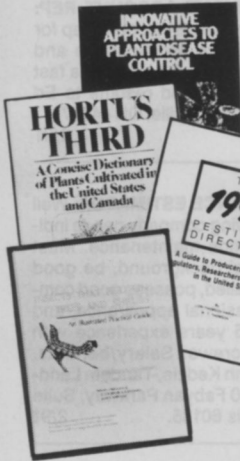
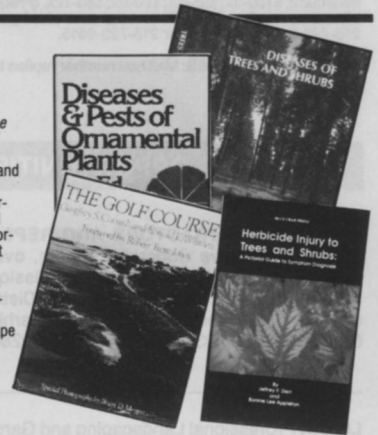

## 510 - HORTUS THIRD

from Cornell University

A 1,300 page concise dictionary of plants cultivated in the United States and Canada. A reference which every horticulture professional should have. **\$135.00**

## 415 - INNOVATIVE APPROACHES TO PLANT DISEASE CONTROL

by Ian Chet

Brings together alternative approaches and methods that have potential to control diseases caused by fungi, bacteria and viruses. Major concepts of disease control discussed include biological control systems, their possible mechanisms, potential application and genetic improvement. **\$54.95**

## 690 - INSECTS THAT FEED ON TREES AND SHRUBS

by Johnson and Lyon

Essential information for identifying more than 650 insect pests and the injuries they cause. More than 200 color illustrations. **\$49.95**

## 500 - THE 1990 PESTICIDE DIRECTORY

by Lori Thomson Harvey and W.T. Thomson

A Guide to Producers and Products, Regulators, Researchers and Associations in the United States. For the person who needs to know anything in the United States pesticide industry. **\$75.00**  
Available in March 1990

## 665 - ARBORICULTURE: THE CARE OF TREES, SHRUBS AND VINES IN THE LANDSCAPE

by Richard W. Harris

Provides comprehensive coverage of complete planting, site analysis, preparation and special planting methods, fully detailed coverage of fertilization, irrigation and pruning guidelines on preventative maintenance, repair and chemical control, how-tos of diagnosing plant problems, practical data on non-infectious disorders, diseases, insects and related pests and pest management. **\$63.00**

## 450 - HANDBOOK OF PLANTS WITH PEST-CONTROL PROPERTIES

By Michael Grange and Saleem Ahmed

Provides information on approximately 2,400 plant species having pest-control properties in addition to the plant's specific common and family names, coded information is provided on such plant characteristics as life cycle, classification, and the ecological conditions suited for growth. Also lists 1,000 plants that are potential candidates for screening pest-control activity due to their poisonous nature or their ability to control human and animal diseases. **\$49.95**

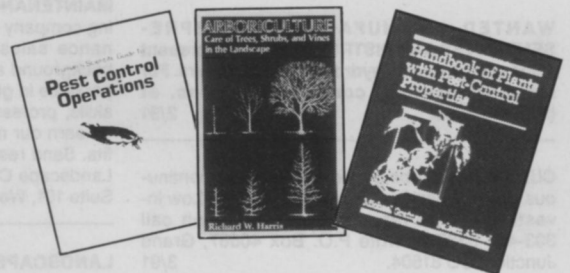

## 125 - SCIENTIFIC GUIDE TO PEST CONTROL OPERATIONS

by G.W. Bennett, J.M. Owens, R.M. Corrigan

Fourth Edition. New chapters on fumigation, urban wildlife, special facilities, plus updated, improved chapters on pesticides, cockroaches, birds, termites, equipment, sanitation, stored product pests and more. Don't be without this updated edition. **\$49.95 Domestic All Others \$60.00**

## 400 - NATIVE TREES, SHRUBS, AND VINES FOR URBAN AND RURAL AMERICA

by Gary L. Hightshoe

This award-winning reference to native U.S. plants has now been expanded to include shrubs and vines. Over 250 major species are characterized by form, branching pattern, foliage, flower, fruits, habitat, soil, hardiness, susceptibility, urban tolerance and associate species. Includes unique color-coded keys that classify plant species by visual characteristics, cultural requirements and ecological relationships. **\$86.00**

## 720 - SHRUB IDENTIFICATION

by George Symonds

Pictorial key to identify shrubs. Contains more than 3,500 illustrations to check specimens. Popular and botanical names are given for each shrub and handy index tabs for quick reference. **\$17.95 paperback**

## 750 - TREE IDENTIFICATION

by George Symonds

Pictorial reference to identifying trees by checking leaves, buds, branches, fruit and bark. Like its sister publication, SHRUB IDENTIFICATION, popular and botanical names are listed with index tabs for easy reference. **\$17.95 paperback**

## 760 - TREE MAINTENANCE

by Pascal Pirone

The sixth edition of this guide for anyone involved in the care and treatment of trees. Special sections on tree abnormalities, diagnosing tree troubles, non-parasitic injuries and assessing the suitability of different trees. **\$45.00**

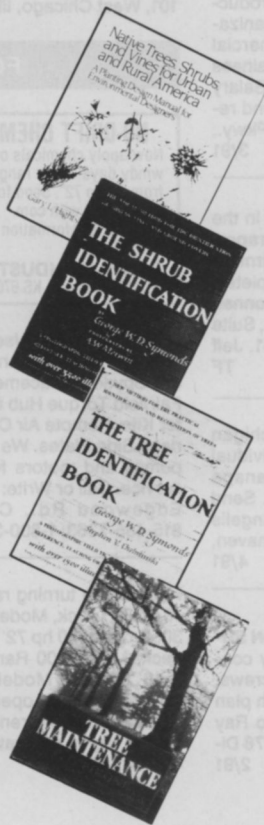

Mail this coupon to: Book Sales, Edgell Communications  
One East First Street, Duluth, MN 55802

Name \_\_\_\_\_

Street Address \_\_\_\_\_

City \_\_\_\_\_

State \_\_\_\_\_ Zip \_\_\_\_\_

Phone Number (\_\_\_\_) \_\_\_\_\_

**PAYMENT MUST ACCOMPANY ORDER**

Signature \_\_\_\_\_ Date \_\_\_\_\_

Please send me the following books. I have enclosed payment\* for the total amount.

Please charge to my Visa, MasterCard or American Express (circle one)

Account Number \_\_\_\_\_ Expiration Date \_\_\_\_\_

BOOK NUMBER AND TITLE	QUANTITY	PRICE	TOTAL PRICE

Domestic—\*Please add \$3.50 per order plus \$1.00 per additional copy for postage and handling.

All others—\*Please add \$5.00 per order and if ordering multiple copies, also add \$2.00 per additional copy to cover postage and handling.

Please allow 6-8 weeks for delivery.

Prices subject to change.

Quantity rates available on request.

Questions? Call 218-723-9471 or 9472

(postage & handling)

Total Enclosed

LM



# CLASSIFIEDS

**RATES:** \$1.25 per word (minimum charge, \$40). Bold face words or words in all capital letters charged at \$1.50 per word. Boxed or display ads: \$105 per column inch-1x (one inch minimum); \$100-3x; \$95-6x; \$90-9x; \$85-12x. (Frequencies based on a calendar year). Agency commissions will be given only when camera-ready art is provided by agency. For ads using blind box number, add \$20 to total cost of ad per issue. Send ad copy with payment to Dawn Nilsen, LANDSCAPE MANAGEMENT, 1 East First Street, Duluth, MN 55802 or call 218-723-9483. Fax Number 218-723-9615.

**BOX NUMBER REPLIES:** Mail box number replies to: LANDSCAPE MANAGEMENT, Classified Ad Department, 1 East First St., Duluth, MN 55802. Please include box number in address.

## BUSINESS OPPORTUNITIES

**WANTED: CONTRACTORS AND REPS** for a proven Decorative Concrete System, over 200 dealers nationwide. Excellent commission and bonuses. Full/P.T. Write to Stampcrete Distributor of N.E., 188 Brandy Brow Road, Haverhill, MA 01830 or call (800)832-7444 or (508)374-9284.

2/91

**LEARN** Professional Landscaping and Gardening at home. Accredited program provides thorough training in all phases of commercial and residential landscaping. Certificate awarded. Free booklet describes program and opportunities in detail. Lifetime Career Schools, Dept. A-415, 2251 Barry Ave., Los Angeles, CA 90064.

9/91

**WANT TO BUY OR SELL A GOLF COURSE?** Exclusively golf course transactions and appraisals. Ask for our catalog. McKay Golf and Country Club Properties, 15485 N. East Street, Lansing, Michigan 48906. Phone (517)484-7726.

TF

**WANTED - MANUFACTURERS REPRESENTATIVES AND DISTRIBUTORS** - to represent a line of high quality hydroseeding tackifiers. For more information, contact PRSM, Inc. at (215)430-3960.

2/91

**CURB KING:** Curbing machine that lays continuous concrete landscape borders. \$2,695. Low investment, high returns. For information call 303-434-5337 or write P.O. Box 40567, Grand Junction, CO 81504.

3/91

## HELP WANTED

**LANDSCAPE MAINTENANCE SUPERVISOR** position available with a rapidly growing landscape firm in Dallas, Texas. We are seeking an individual who possesses enthusiasm, sincerity and honesty, as well as leadership, organizational and production skills. In other words, a "DO WHATEVER IT TAKES" type. Extensive industry knowledge and experience, a MUST. Strong salary and benefits. Send resume and salary history to: 8222 CHANCELLOR ROW, DALLAS, TEXAS 75247, ATTN: PRESIDENT.

2/91

**TWO POSITIONS AVAILABLE: EXPERIENCED ESTIMATOR & CONSTRUCTION GENERAL SUPERVISOR.** General Contractor seeking individuals experienced in estimating and site development. Supervision of personnel and dealing with governmental agencies required. Send salary and resume to: DeAngelis Contractors, 22424 Van Horn, Woodhaven, MI 48183. E.O.E.

4/91

**SALE-DESIGN-ESTIMATING:** A large high quality service oriented site construction corporation is looking for a highly motivated individual to join our team. Must have construction background, excellent communication skills, and a professional manner and appearance. Benefits and pay are commensurate with ability and experience. Send resume to Decorative Paving Co., 33 West 518 Fabyan Parkway, West Chicago, IL 60185. 3/91

**NEED LANDSCAPE WORKERS?** We can solve any labor problem you have. We have documented workers as well as foremen, leadmen, irrigators and architects available at a price you can afford. Call today! AMIGOS 214-634-0500. TF

Our continuing growth requires us to find qualified personnel for the following new positions: **ESTIMATOR:** 5-7 years minimum experience with emphasis in commercial estimating. Must have experience in the buy-out of plants, hard goods and sub-contracts. **PROJECT MANAGER:** Must have the ability to coordinate and manage multiple projects simultaneously. You will be responsible for communicating with major clients, management and field supervisors. Administrative skills with attention to follow-up and detail is necessary. If you are the type of individual that thrives on responsibility and can operate with little direction, we would like to hear from you. We have salaries and benefits. Please submit a resume with a cover letter and salary history to: TORRE & BRUGLIO, INC., 20401 Hall Road, Mt. Clemens, MI 48044. Attn: President.

3/91

**ASSISTANT MANAGER/SALES LANDSCAPE MAINTENANCE:** Well established, rapidly growing company needs individual to assist in maintenance sales. Must have strong horticultural background and sales experience; 2-5 years experience in green industry. Good communication skills, professional appearance, and willingness to learn our methods are essential. Salary/benefits. Send resume to: Mr. Glenn Kedzie, Tandem Landscape Company, 33W480 Fabyan Parkway, Suite 101, West Chicago, Illinois 60185.

2/91

**LANDSCAPE MAINTENANCE PRODUCTION MANAGER:** Rapidly growing Central Florida Landscape firm seeking an experienced production manager with strong people and organizational skills. Experience with large commercial accounts and a sincere desire to build a business based on customer service a must. Strong Salary and Benefits. Must relocate to Orlando. Send resume to: Mr. Khalsa, 1174 Florida Central Pkwy., Longwood, Florida 32750.

3/91

"Consider all of your employment options in the irrigation and landscape industries. Call **Florapersonnel**, the international employee search firm for the ornamental horticulture industry. Completely confidential. Employer pays fee. **Florapersonnel, Inc.**, P.O. Box 1732, 1450 S. Woodland Blvd., Suite 201, DeLand, FL 32721-1732. (904)738-5151. Jeff Brower, Joe Dalton, Bob Zahra, CPC."

TF

**Landscape Supervisor:** Established Michigan Contractor looking for self-motivated individual with 5 years minimum experience to manage crews and oversee landscape installation. Send resume and salary requirements to: DeAngelis Contractors, 22425 Van Horn Road, Woodhaven, Michigan 48183. EOE.

4/91

**LANDSCAPE MAINTENANCE PRODUCTION SUPERVISOR:** Responsibilities include quality control, productivity and customer service for 5 crews. 4 years experience and hort. degree. Health plan with dental. Profit-sharing. Send resume to Ray Knoll, Western DuPage Landscaping, 31W478 Diehl Rd., Naperville, IL 60563.

2/91

**LAWN CARE MANAGER:** Seeking individual to coordinate lawn care operations. Responsibilities include all aspects of marketing, sales and production of all lawn care related services. 4 years experience and hort. degree. Health plan with dental. Profit-sharing. Send resume to Ray Knoll, Western DuPage Landscaping, 31W478 Diehl Rd., Naperville, IL 60563.

2/91

**LANDSCAPE MANAGEMENT ACCOUNT REP:** Large Northeast Ohio firm needs Account Rep for existing and new accounts. Horticulture and Agronomics background helpful. Be a part of a fast growing, diverse company. Send resume to Ed Gallagher, P.O. Box 438, Painesville, OH 44077.

2/91

**LANDSCAPE MAINTENANCE ESTIMATOR:** Well established, rapidly growing company needs individual to estimate grounds maintenance. Must have strong horticultural background, be good with numbers, highly detailed, possess good communication skills, professional appearance, and willingness to learn. 3-5 years experience with grounds maintenance crews. Salary/benefits. Send resume to: Mr. Glenn Kedzie, Tandem Landscape Company, 33W480 Fabyan Parkway, Suite 101, West Chicago, Illinois 60185.

2/91

**LANDSCAPE MAINTENANCE PRODUCTION SUPERINTENDENT:** Well established, rapidly growing company needs individual capable of running multiple crews. Must be good with people, have a strong horticultural background, good communication skills, a professional appearance, be highly organized, and eager to learn. 5-7 years experience with grounds maintenance. Salary/benefits. Send resume to: Mr. Glenn Kedzie, Tandem Landscape Company, 33W480 Fabyan Parkway, Suite 101, West Chicago, Illinois 60185.

2/91

## FOR SALE

### NO-DRIFT CHEMICAL APPLICATOR

Now apply chemicals on windy days! Sizes range from 30" to 72". Send for free packet with complete parts information and prices.



**DANVILLE INDUSTRIES**  
Box 12 • Danville, KS 67036

(316) 962-5292  
1 (800) 662-4212

**SPYDERS - New/Used/Rebuilt.** New Kohler engines, short blocks and a complete line of engines and Spyder replacement parts. New Style Nichols-Fairfield Torque Hub Kits, heavy duty Wilton Caster Kits, Remote Air Cleaner Kits, heavy duty Carriage Side Plates. We repair and rebuild hydraulic pumps and motors for your Spyder. Same day service. Call or Write: Mobile Lift Parts, Inc., 5402 Edgewood Rd., Crystal Lake, IL 60012. 815-455-7363; 1-800-397-7509.

3/91

Husler zero turning radius mowers: 2-Model 251 18 hp 50" deck, Model 272 23 hp 72" deck, Model 305D diesel 20 hp 72" deck, Model 262 18 hp 60" deck, Model 400 Rangewing 24 hp 1-72" deck, 2-40" decks, Model 400 D 24 hp 72" deck. \*Mowers only in operation 2 seasons and have been completely renovated for a new season. Owner highly motivated to sell. Call Mr. Khalsa. 407-831-8101.

3/91