

THE GREEN MACHINE

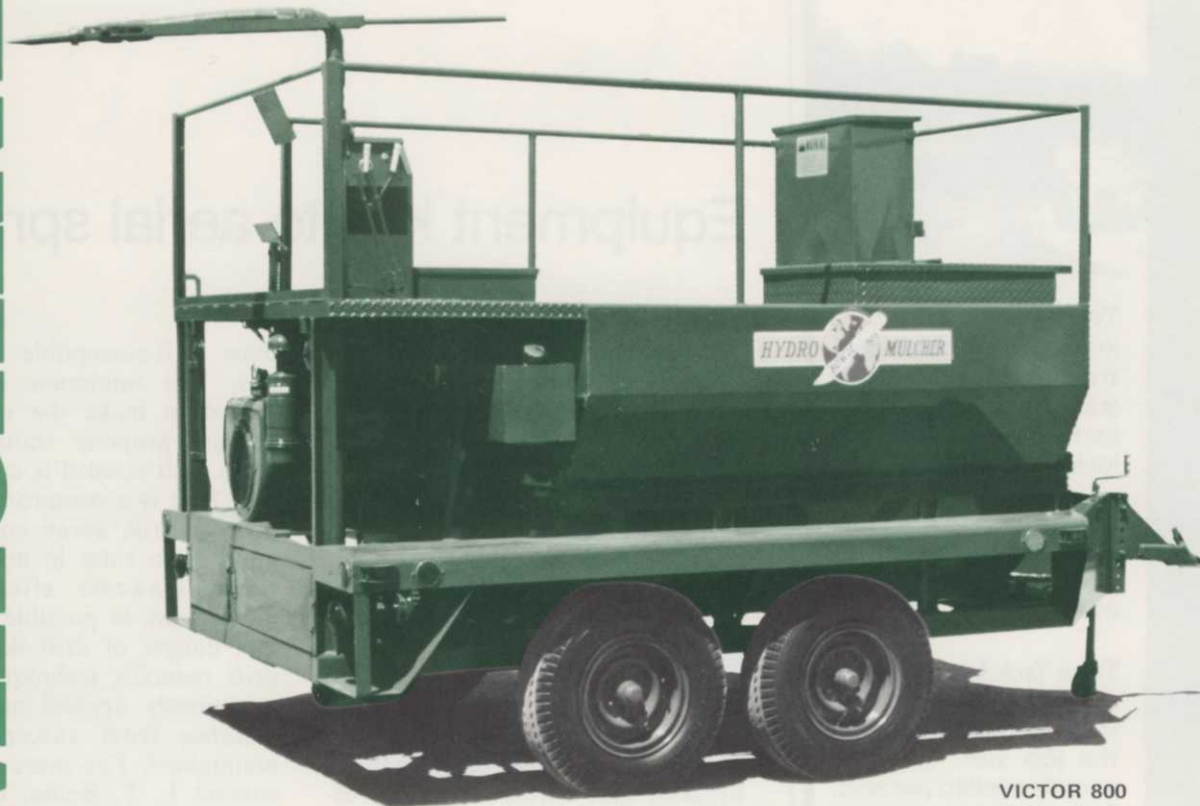

VICTOR 800

This is the machine that revolutionized the turf industry... the machine that seeds or sprigs, fertilizes, waters, sprays, and mulches in one easy operation... the Bowie Hydro-Mulcher.

Its performance and reliability are unequalled. Its capabilities have created a whole new industry of lawn and turf, ground cover and erosion specialists. The Bowie Hydro-Mulcher is the daddy of them all... the green machine.

EXCLUSIVE BOWIE HYDRO-MULCHER FEATURES:

- Only proven unit for both sprigging and seeding with cellulose fiber mulches.
- Can mulch, fertilize and seed or sprig half an acre in eight minutes.
- Has enclosed shredder bar for shredding full bales of cellulose fibers.
- Has centralized tower control with no hoses.
- Has triple agitators for faster mixing and eliminating sediment build-up.
- Uses pump only for spraying, so pump lasts longer.
- Slurry passes through pump only once, thus reducing seed damage and clogging.
- Has spray mist and other accessory nozzles for such uses as insect control, tree spraying and fire fighting.
- Six models - from 350 to 3,000 gallon capacity.

CALL OR WRITE FOR COMPLETE DETAILS:



LANCER 350



WINDSOR 1000



IMPERIAL 1500, 2500 & 3000

HYDRO



MULCHER

BOWIE INDUSTRIES, INC. / P. O. BOX 931 / BOWIE, TEXAS 76230 / (817) 872-2286

Terra Tack: Erosion Protection



Terra Tack holds mulch in place for erosion control of newly seeded areas by forming a water insoluble, gelatinous locking membrane.

Can be used to bind hay or straw and to secure wood or paper fiber mulches.

Terra Tack formulations are packaged in powder form and are mixed on the job site. Only 40 pounds needed per acre. Storage and transportation costs are at a bare minimum.

Saves equipment. . .
Saves manpower. . .
Gets results!

Untreated Soil



Terra Tack Treated Soil

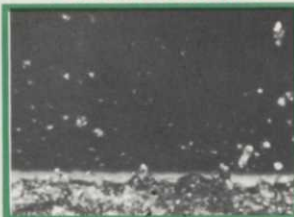

Grass Growers

P. O. Box 584
Plainfield, N.J. 07061
(201) 755-0923

Equipment key to aerial spraying

Effective and efficient application of agricultural chemicals by aircraft depend largely on the selection and proper use of the application equipment.

According to Agricultural Research Service-USDA and Texas Agricultural Experiment Station scientists, sprays which are atomized finer than required usually result in higher drift losses from the target area.

Nozzle orientations which provide a higher degree of mechanical breakup and excessive spray pressure are two major factors that pro-

duce drift-susceptible spray droplets. The minimum pressure required to make the spray system operate properly should be used when drift control is critical.

There is a compromise between drift control, spray coverage, and application rates in many applications. However effective aerial application is possible with minimal danger of drift damage when drift reducing techniques are conscientiously applied and adequate distance from susceptible crops maintained. For more information contact L. F. Bouse, College Station, TX. 713-846-8821.

Versatile new Hypro sprayer pump

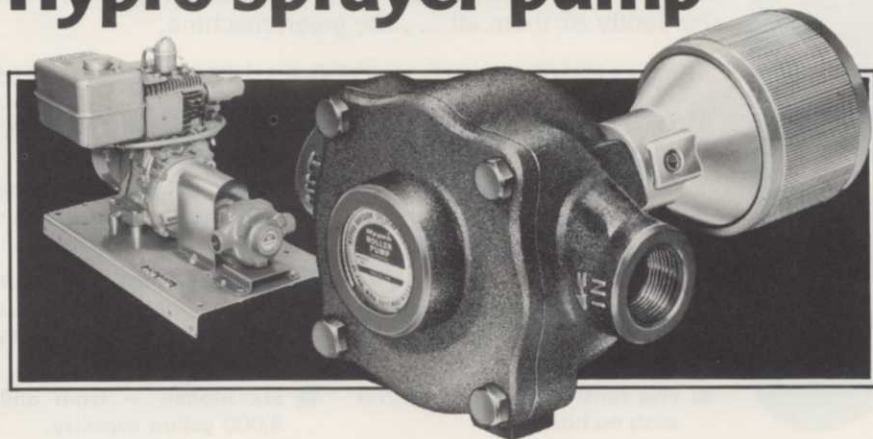

Hypro series 6500 pump has a wide range of uses. It will deliver up to 20 gpm (at 1200 rpm) or develop pressures to 300 psi, and it is available in either cast iron or Ni-Resist. Its 5/8" shaft is stainless steel. Rolling vanes and cartridge type seals are available in a choice of materials.

The pump is designed for weed and insect control chemicals but it is also used for many industrial solvents. It is available with or without a PTO shaft adapter or as a complete pumping unit, model GN6500R, with gas engine and mounting base as shown.

Hypro. / **ISI**

A division of Lear Siegler, Inc.
347 Fifth Ave NW, St. Paul, Minn. 55112

Circle 119 on free information card

The Stately Elm

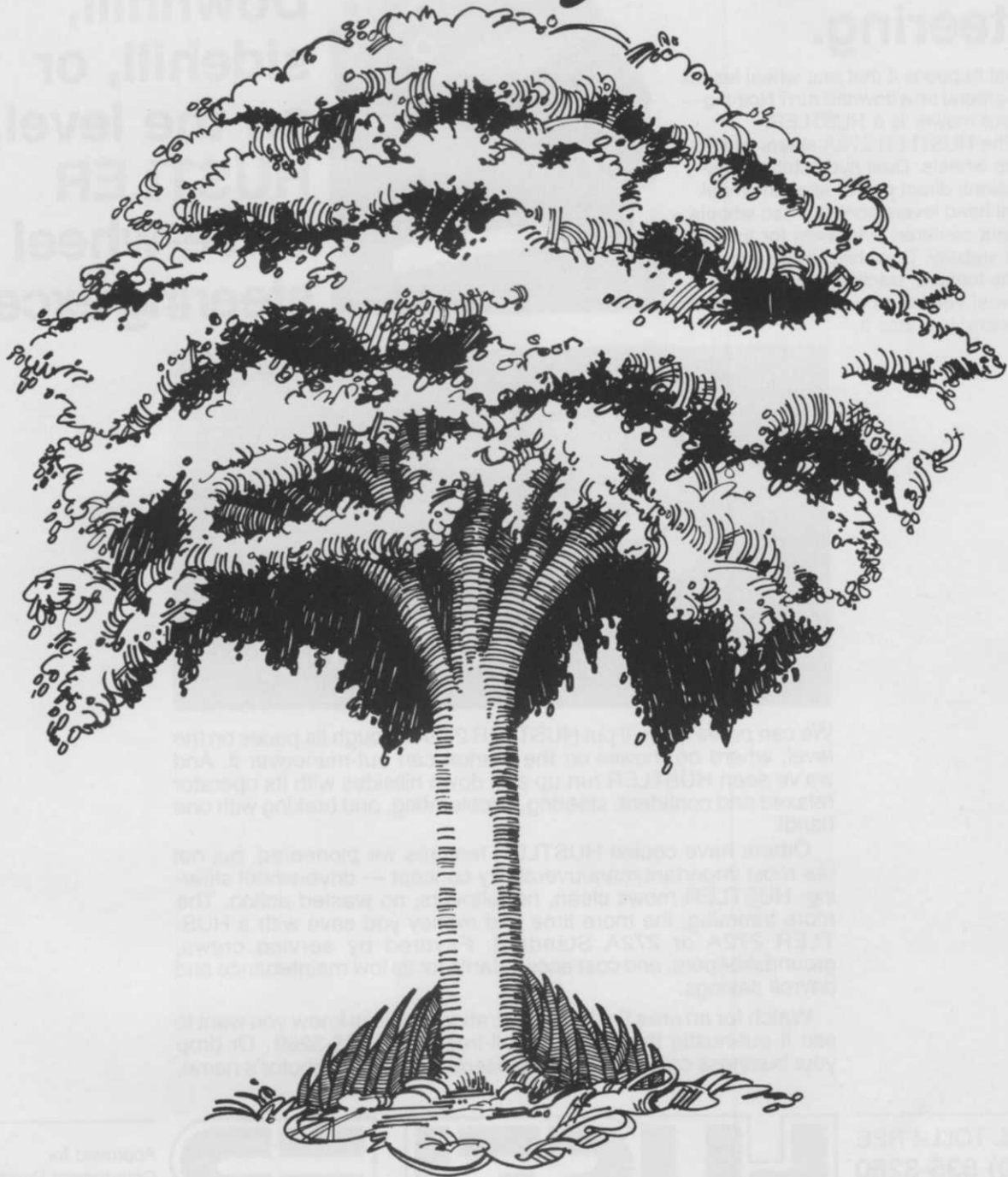

Help protect the American Elm from Dutch Elm Disease with

CORREX™

* Contains DuPont Lignasan BLPTM Fungicide.

A fungicidal aid injected into elms to help prevent infection of the American Elm by Dutch Elm Disease. CORREX arrests the spread of DED if infection is minimal at the time of injection.

Tested and approved by Elm Research Institute, Harrisville, NH.



Call or write for details;



Hopkins
agricultural chemical co.

Box 7532, Madison, WI 53707
608/222-0624

Don't fall for rear-wheel steering.

What happens if that rear wheel leaves the ground on a downhill run? Nothing—if your mower is a HUSTLER.

The HUSTLER 272A steers with its drive wheels. Dual hydrostatic transmissions direct power to each wheel. Dual hand levers control those wheels, weight centered over them for traction and stability. Downhill, as the weight shifts forward, traction actually improves! You keep control. On rear-steer mowers, you lose it.



Downhill, sidehill, or on the level, HUSTLER drive-wheel steering excels.



We can prove it. We'll put HUSTLER 272A through its paces on the level, where no mower on the market can out-manuever it. And we've seen HUSTLER run up and down hillsides with its operator relaxed and confident, steering, accelerating, and braking with one hand!

Others have copied HUSTLER features we pioneered, but not our most important maneuverability concept — drive-wheel steering. HUSTLER mows clean, no leftovers, no wasted action. The more trimming, the more time and money you save with a HUSTLER 272A or 272A Standard. Favored by service crews, groundskeepers, and cost accountants for its low maintenance and payroll savings.

Watch for an area field demonstration, or let us know you want to see it out-hustle the rest. Call toll-free: (800) 835-3260. Or drop your business card in the mail for literature and Distributor's name.

CALL TOLL-FREE
(800) 835-3260

In Kansas and Canada:
(316) 327-4911 collect

HUSTLER

Turf Equipment

Approved for
Government Purchase:
GSA# GS-07S-01404
HUD# OAH (CO) n 2012

Excel Industries, Inc. • Box 727WTD • Hesston, KS 67062

GOODALL

The Goodall Fillies



Introducing the 36 inch cut Goodall Rear Discharge mower. A new design deck allows close trimming on both sides, helps prevent windrows and gives you a clean manicured cut (not that just-cut look). The new variable speed drive gives a wider range of ground speeds. The 3 gallon fuel tank and Hi-Way front caster wheels are standard equipment. This new mower is designed for fine lawns and rough areas. The finger tip control gives the same easy handling and hillside stability and maneuverability as the other Goodall Self-Propelled models. Also available is a new 52 inch rear discharge mower.

Goodall Div. • 1405 Bunton Road • Louisville, Kentucky 40213
Phone 502/459-3811 Telex 204-340

Circle 111 on free information card

Our Customers Insist

Princeton's "Self-Propelled" Sod Harvester is Unbeatable!



Richard P. Jenks, President
REDETURF, INC.
Hubbard, Oregon

"Redeturf personnel have experience with all commercially available sod harvesters and we feel the Princeton method is the best. We have used the Princeton "Self-Propelled" since 1968 and have cut our labor force enough to pay for several machines."

David W. Picha, General Manager
EMERALD TURF GRASS FARMS
Sumner, Washington

"We harvested over 20 million square feet of sod with a Princeton "Self-Propelled" before the first overhaul."

Stanley F. Cruse, Vice Pres./General Manager
PURSLEY TURF GRASS
Palmetto, Florida

"Harvesting quality turf grass requires quality equipment. That's why we use Princeton."

Our customers say it best. Increase your profits...by reducing costs and increasing production. Three man crew can harvest 22,500 sq. ft. of sod per hour with Princeton's "Self-Propelled" Sod Harvester.

There's a Princeton for Everyone.



Designed to meet the special needs of the smaller volume sod producer. Operates behind any adequately sized, low speed tractor. Exclusive "2 minute hook-up" capability allows complete flexibility in the use of your power supply. With a 3-man crew, harvest up to 13,500 sq. ft. of sod per hour...palletized, ready to ship. The "Tow Boy" Sod Harvester...a real Princeton at one third the cost of our larger machines.

The only sod harvester that does it all...with just one man! Cuts, aerates, crossie stacks, and palletizes 27,000 sq. ft. of sod per hour with a crew of one. Save time, money, and man hours. For the large volume sod producer who wants to increase production and profit. The Princeton "Automatic" Sod Harvester.



Chuck Braun
Sales Manager
955 W. Walnut Street
Canal Winchester, Ohio 43110
(614) 837-9096

For additional information write or call collect:

PRINCETON

MANUFACTURING COMPANY

Circle 146 on free information card

APRIL 1977/WEEDS TREES & TURF 55

Only way to total lawn weed control!

Super D WEEDONE[®] applied by METER-MISER[®]



Dealers and Contractors. Need a METER-MISER? Contact your Distributor or Amchem.



AMCHEM PRODUCTS, INC.
Ambler, Pennsylvania 19002

Circle 141 on free information card

LAWN CARE INDUSTRY

DAVEY TREE EXPERT CO. expands Lawnscape service.

Effective March 1, 1977, Davey Lawnscape Service, the chemical lawn care division of The Davey Tree Expert Co., has expanded its Akron, Canton and Cleveland operations and opened new offices in Detroit and Pittsburgh.

"The reason we are expanding our Lawnscape operation is because of the tremendous acceptance this Davey service has received in Akron, Canton and Cleveland over the past two years," said J. Martin Erbaugh, general manager, Lawnscape division.

The new Detroit office, located at 1908 Thunderbird St., Troy, will be managed by Frederick J. Fassett.

In Pittsburgh, Gordon L. Ober will head the new operation based at Spring Run Rd., Corapolis.

• • •

HOW MUCH IS THE LAWN of a suburban home worth?

O.M. Scott & Sons decided to find out. They asked an independent research organization to put the question to 98 realtors, located in Chicago, Denver and Northern New Jersey.

In the survey, the realtors first were asked what dollar difference a thick, green, weed-free lawn would make in the sale price of a \$45-50,000 home. Their replies indicate that a lawn improved this way would add an average of more than \$1,400 to the resale value. Attractive flowers, trees and shrubs, they feel, would add about \$1,500 more, for a total of \$2,900.

When asked "Why do/don't you think a thick, green, weed-free lawn would increase the speed of the sale?" almost three-fourths of the realtors say it makes a significant difference, and 24 of these cited the importance of a good first impression.

Other reasons given included the way a nice lawn enhances the whole property, the fact that it provides a good guide to the condition of the house and the savings in time and money to the buyer.

• • •

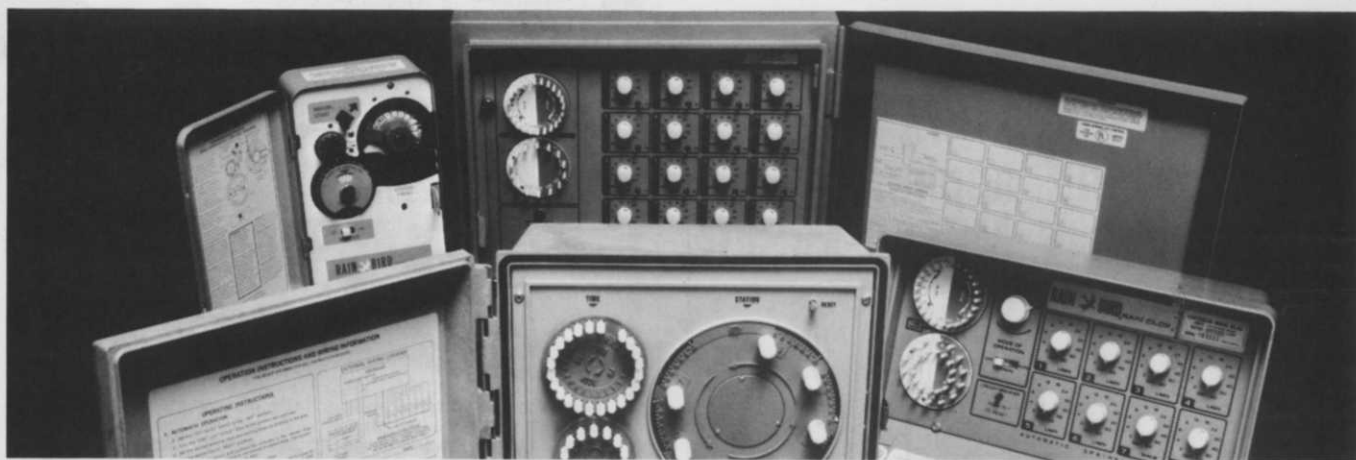

With Rain Bird® controllers, lush landscapes are just a matter of time.

Our controllers help everything grow greener. Just like clockwork.

Whether you need our dual master unit that controls up to 36 satellite units, our basic three station controller, or anything in between for commercial, residential or golf course applications, Rain Bird covers the field — without wasting a drop.

That's because our entire line, including the models you see above, all feature calendars, 24-hour clocks and timing dials that let you select the day,

hour and length of rain at each station. And, many of the controllers are capable of shutting down the system automatically when nature pours it on.

Best of all, every Rain Bird® controller is a dependable, hard-working disciplinarian that means satisfaction — for everyone.

So exercise some timely control out on the turf with Rain Bird controllers. Contact your local Rain Bird distributor for complete details.

RAIN BIRD®
Bringing new ideas to life.

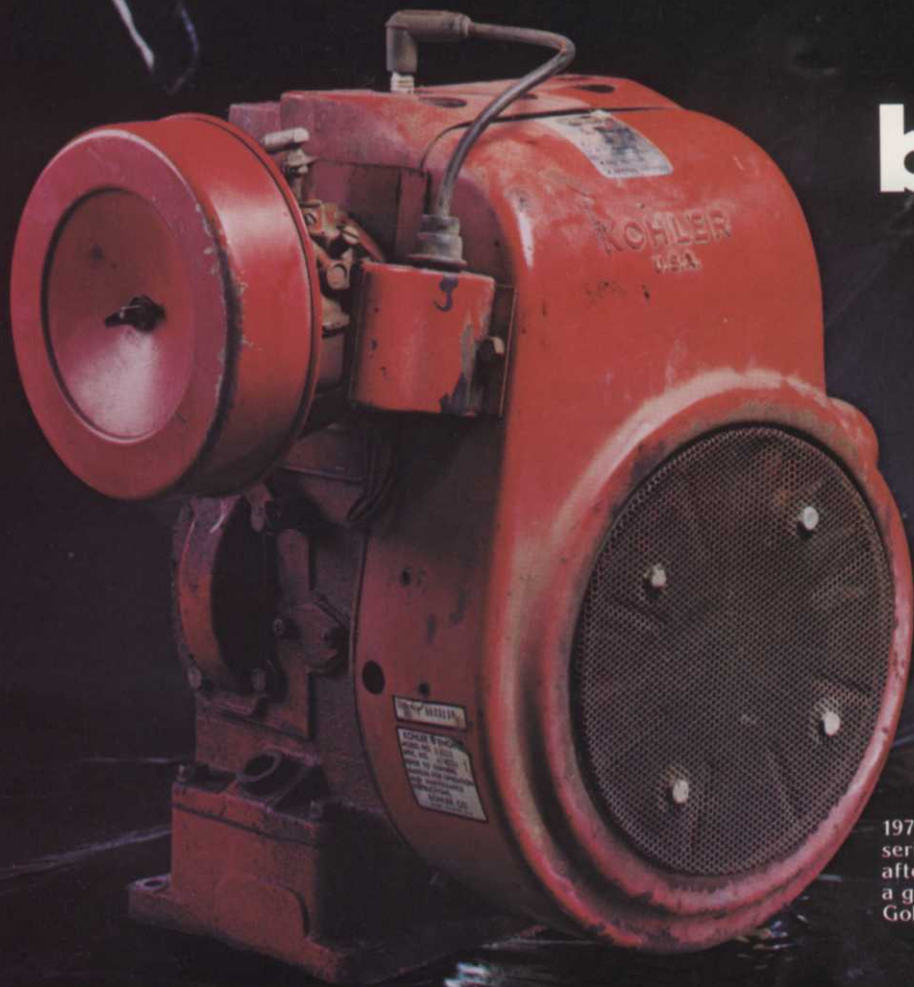

beautiful

1970 12 HP KOHLER K301S—
serial 3033139. Still running strong
after 3966 hours of operation on
a greens mower at Salt Creek
Golf Club, Itasca, Illinois.

**If your equipment
is Kohler powered, you know what we
mean by "Beautiful."**

You judge the beauty of your equipment in terms of long life, rugged dependability and strong factory service support.

It's the kind of beauty that lasts. Not the shiny paint and flashy chrome kind of beauty, but the kind of beauty that comes with years of dependable performance.

Dependable performance that adds value to your equipment. Value you can measure in hours, days, weeks and years on the job.

This is just one of the many beautiful examples that will convince you to specify Kohler cast iron 4-cycle engines (4 to 23 h.p.) on your equipment.

If you'd like more information on Kohler's Cast Iron beauties, write:

ENGINE DIVISION
KOHLER CO. KOHLER, WISCONSIN 53044

KOHLER

Circle 133 on free information card

lulituped

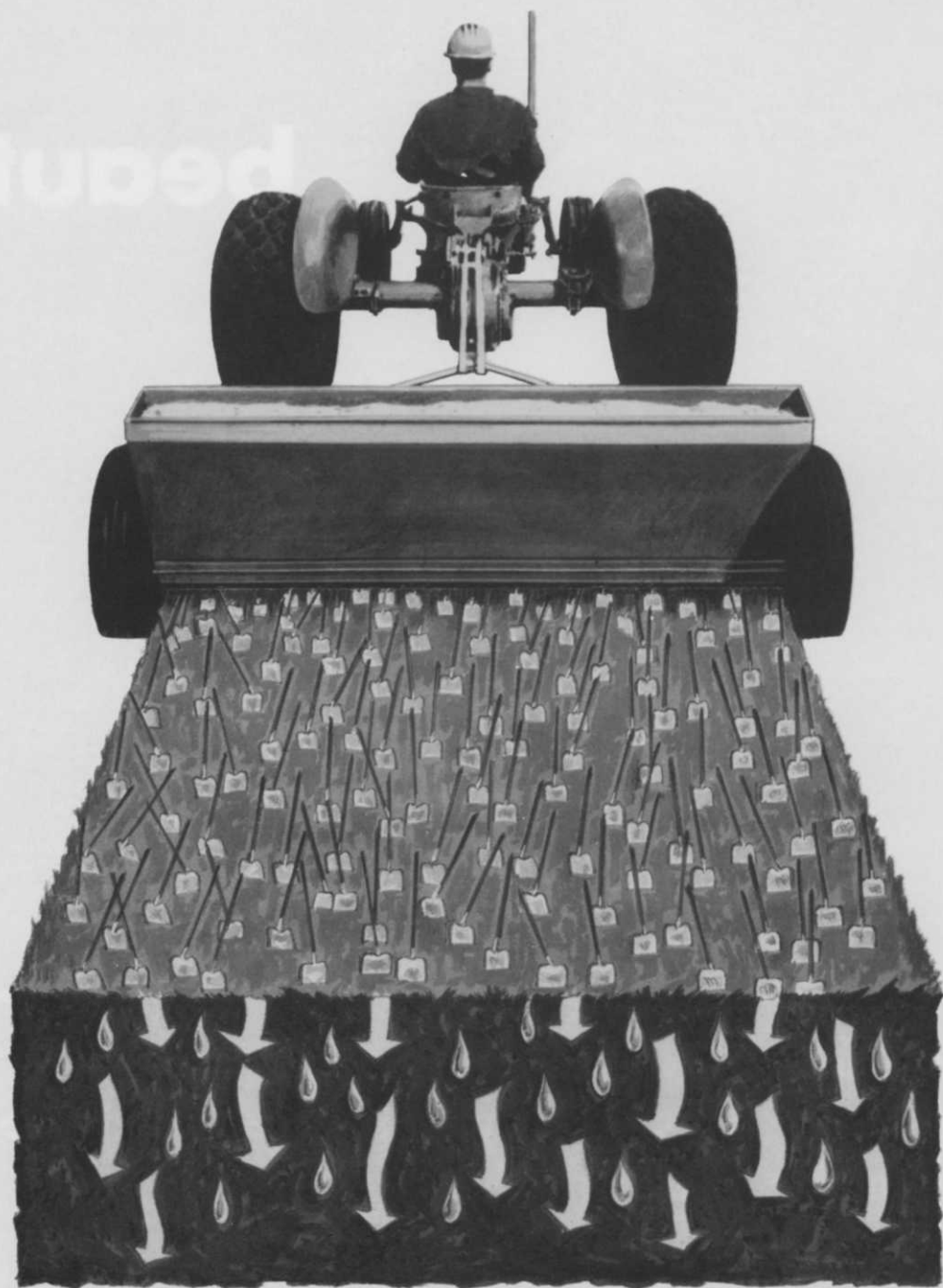

**Low cost conditioner loosens clay!
Works like millions of tiny hoes.™**

Sof'n-soil™ Gypsum works its way down to break up compacted clay soil so it can breathe, lets air and water penetrate, boosts efficiency of costly fertilizers. A natural mineral, Sof'n-soil produces vigorous root systems, promotes growth of grass, trees, shrubs, and flowers. Ecologically safe, Sof'n-soil is



not a lime. It's neutral, non-caustic, non-burning—harmless to plants, pets, and people. And here's a bonus: Sof'n-soil supplies soluble calcium and sulfate sulfur in readily available form, stimulates decomposition of organic materials, too. Write to us at 101 S. Wacker Dr., Chicago, Ill. 60606. Dept. WTT-47

CHEMICALS DIVISION

UNITED STATES GYPSUM
Primary supplier of secondary plant nutrients

THE BEST NOW BUILT EVEN BETTER!



BROUWER MODEL A3A SOD HARVESTER

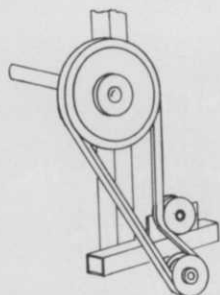

VARIABLE CUT-OFF DRIVE

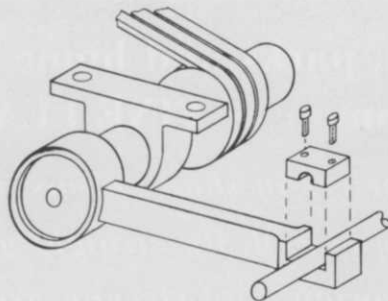

SPLIT CONNECTING RODS

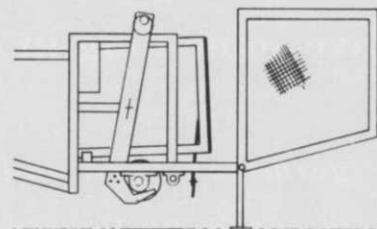

O.S.H.A. SAFETY GUARDS

NEW IMPROVED FEATURES INCLUDE —

- ★ Variable Cut-off Drive (Instantly adjusts to desired length)
- ★ Split Connecting Rods (Quick "V" Belt replacement)
- ★ Safety Guards (Head Guard becomes stand for blade changes etc.)
- ★ Many other improved Service & Production features

★★ Variable cut-off drive & split con rods available for previous models.

FOR FULL DETAILED INFORMATION OF THE NEW BROUWER A3A,
or PARTS CONVERSION KITS — CALL OR WRITE



BROUWER
TURF EQUIPMENT LTD.

MANUFACTURER & DISTRIBUTOR

R. R. No. 1, Keswick, Ontario L4P 3C8, Phone: (416) 476-4311

Pick-proof lock available

With burglaries and vandalism on the increase, the publishers of WEEDS TREES & TURF have launched a program to make information available on a new security lock.

The front knob of the lock contains an exclusive slip clutch that adds to the pick-proof features. Intruders can't twist the knob off to gain entry to homes, machine sheds and storage areas. Each lock has an automatic dead locking plunger to prevent entry with a plastic card or thin knife.

The lock opens by dialing a correct sequence of four numbers,

much like a telephone. Once closed, the door is secure and can't be re-opened without dialing the exact combination again . . . unless the inside bypass has been activated.

Housewives, children and female employees like the lock because there are NO KEYS to fumble with, lose, hide or fall into wrong hands. The unit can also have a number change for added security without calling a locksmith. Each lock carries a full one year warranty.

The lock casing is heavy duty cast aluminum and the parts are self-lubricating. All parts are made of rust or corrosion-resistant materials. □

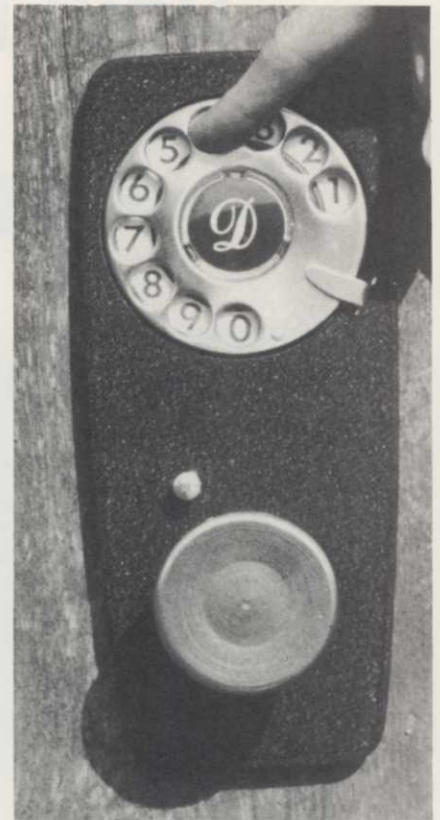

Most good golf courses, parks and home lawns have something in common — FINE LEAFED FESCUE

Oregon Fine Fescue - thrives in shady areas, does well in dry spells, germinates fast and blends well. Its straight-growing habit holds the grass up for even mowing, and Oregon grown Red Fescue even creeps to cover the spots left when other grasses fail.



Oregon Fine Fescue the grass seed on which
the best mixes are built.

For a brochure and sample, write: Oregon Fine Fescue 1349 Capitol N.E. Salem, Oregon 97303