

LANDSCAPE MANAGEMENT

A silhouette of a person wearing a cap and pulling a lawn mower across a grassy area. The background is a warm, orange-red sunset sky. The person is on the left, facing right, and the lawn mower is on the right, facing left. The overall scene is in silhouette against the bright sky.

**1990
BUYERS GUIDE**



PennLinks[®]

is on top of it all at The Cliffs

"Things are bigger here in Possum Kingdom, Texas. For instance, our 180,000 square feet of PennLinks greens that perform flawlessly in our extremes of heat, humidity and cold.

"We hand mow our greens at 3/16". The longer cut stresses the plant less, and promotes deeper, healthier roots. With PennLinks' upright growth habit, there's no need to mow shorter for a 'true' putt and the leaf length helps hold the ball on our extremely contoured greens.

"We realize a substantial monetary and labor savings with PennLinks. Its strong root system requires less syringing; we verticut and topdress only twice yearly, and have not had to apply any preventive fungicide since seeding in the spring of 1987.

"PennLinks also shows quick recovery from Texas-type trials like drought, water loss for 3-4 days, 2 inch hailstones, pythium and deer damage.

"I feel any superintendent who looks at all available bents with an open mind, and does his homework as I have, will choose PennLinks over any other. That's why PennLinks is on top at The Cliffs."

Randy Thompson, CGCS

Director of Golf and Course Management
The Cliffs, Possum Kingdom, TX

*Avon Hagge and Assoc. designed course
Developed by Sheffield Management Co.*

Fallon, Randy and Lisa Thompson



"I like PennLinks because it's easy to live with... my family likes PennLinks because I'm easier to live with."

Randy Thompson

In the exclusive
"Penn Pail"



Tee-2-Green Corp.

PO Box 250, Hubbard, OR 97032
503-981-9574 / FAX 503-981-5626

1-800-547-0255

Circle No. 162 on Reader Inquiry Card

LANDSCAPE MANAGEMENT



On the cover: Landscape Management again offers you the industry's most complete guide to the manufacturers and suppliers of turf equipment.

1989 BUYERS' GUIDE

- 27 Equipment
- 59 Equipment companies
- 72 Chemicals
- 90 Chemical companies
- 97 Seed and seed companies

DEPARTMENTS

- 4 As I See It...
- 3 Green Industry News
- 14 Short Cuts
- 22 Athletic Turf
- 104 Products
- 107 Classified
- 110 Ad Index

LANDSCAPE MANAGEMENT (ISSN 0894-1254) is published monthly by Edgell Communications, Inc. Corporate and Editorial offices: 7500 Old Oak Boulevard, Cleveland, Ohio 44130. Advertising Offices: 7500 Old Oak Boulevard, Cleveland, Ohio 44130, 111 East Wacker Drive, Chicago, Illinois 60601 and 3475 Lenox Road, N.E., Suite 665, Atlanta, Georgia 30326. Accounting, Advertising Production and Circulation offices: 1 East First Street, Duluth, Minnesota 55802. Subscription rates: \$25 per year in the United States; \$50 per year in Canada. All other countries: \$100 per year. Single copies (pre-paid only): \$2.50 in the U.S.; \$5.00 in Canada; elsewhere \$10.00; add \$3.50 per order for shipping and handling. Back issues, if available, \$10; add \$3.50 per order for shipping and handling (pre-paid orders only). Office of publication: Edgell Communications, Inc., 1 East First Street, Duluth, Minnesota 55802. Second class postage paid at Duluth, Minnesota 55806 and additional mailing offices. Copyright© 1989 by Edgell Communications, Inc. All rights reserved. No part of this publication may be reproduced or transmitted in any form or by any means, electronic or mechanical including photocopy, recording, or any information storage and retrieval system, without permission in writing from the publisher.

POSTMASTER: Send address changes to LANDSCAPE MANAGEMENT, P.O. Box 6198, Duluth, Minnesota 55806.

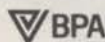

REMEMBER THE Roundup[®]



Along
sidewalks
and
paved areas

Around
tree bases

For edging
along
pond banks



For edging
around
parking lots

Around
buildings and
other
structures

Under
benches

Now's the time to Remember ROUNDUP® herbicide for all kinds of jobs around parks and recreational areas. Remember that ROUNDUP controls a broad spectrum of weeds roots-and-all. ROUNDUP is faster to use than mechanical trimmers and there's no need to retreat. That means you'll save time and labor.

Remember that ROUNDUP stays where you put it...so there's no washing or leaching problems to harm desirable vegetation. And Remember that ROUNDUP is biodegradeable and

won't build up in the soil. That fact will give you the environmental confidence you need to use ROUNDUP everywhere you've got a weed, brush, trimming or edging problem. Spray with confidence — REMEMBER THE ROUNDUP.

Always read and follow label directions for Roundup® herbicide. Roundup® is a registered trademark of Monsanto Company.
© Monsanto Company 1989 RIP-9-201-D

Monsanto

For complete information on the many benefits of Roundup herbicide for Parks and Recreational facility managers, call toll-free

1-800-225-2883

Circle No. 142 on Reader Inquiry Card

From the other side of Earth: Can we talk?



If you take for granted your ability to communicate with those around you, then attending the 6th Annual International Turfgrass Research Conference (ITRC) in Tokyo last month would have been eye-opening. Not only would you have enjoyed papers delivered by the world's preeminent turfgrass researchers, you'd have seen the awesome power of communication working (or, in some cases, not working).

For the first time, the ITRC's host was a nation on the mysterious, often misconceived continent of Asia. Though relative newcomers to turf research, the Asians appeared to pursue turf knowledge as diligently as they have other scientific fields once thought to be the private domain of Western civilization.

Still, the cultural barriers between lands were evident, most notably language. Though translators performed admirably within classroom walls, the informal "corridor conversations" so important in a gathering of this type had a distinct East/West feel—as in East on one side of the corridor and West on the other.

It is apparent that our nations have a long way to go toward fully understanding each other. The blending of our cultures will continue to progress in step with today's global economy. Perhaps the most important element in maintaining positive relations during that progression will be a continued effort to improve communication, to overcome the momentary frustrations many of us may experience.

Perhaps one day landscapers in Okayama and Oklahoma will be equally interested in our Buyers' Guide, presented to you this month. Each will benefit from an easy-to-use, comprehensive listing of the companies that provide the instruments necessary to do a job properly. Until then, we're glad we can bring you the 1989 "North American" Buyers' Guide. Think of it as a way to get your hands on the tools and information you need to beautify wherever it is you call home.

Will Perry, managing editor

EDITORIAL STAFF

Jerry Roche, Executive Editor
Will Perry, Managing Editor
Terry McIver, Associate Editor
Office: 7500 Old Oak Blvd.
Cleveland, OH 44130
(216) 243-8100
FAX (216) 826-2832

MARKETING STAFF

Dick Gore, Publisher
Office: 3475 Lenox Rd. N.E.
Suite 665
Atlanta, GA 30326
(404) 233-1817
FAX (404) 261-7022

Jon Miducki, National Sales Manager
Marsha Dover, Midwest Sales Manager
Barbara Thomas, Eastern Sales Manager
Bob Earley, Group Vice President
Office: 7500 Old Oak Blvd.
Cleveland, OH 44130
(216) 243-8100
FAX (216) 826-2832

Robert Mierow, W. Coast Representative
Office: 1515 NW 51st Street
Seattle, WA 98107
(206) 783-0549
FAX (206) 784-5545

Tom Greney, Senior Vice-President
Office: 111 East Wacker Drive
Chicago, IL 60601
(312) 938-2317
FAX (312) 938-4850

SUPPORT STAFF

Carol Peterson, Production Mgr.
Marilyn MacDonald, Prod. Supervisor
Lynn Williams, Graphic Design
Jackie Eisenmann, Circulation Super.
Bonnie DeFoe, Directory Coordinator
Gail Parenteau, Reader Service Mgr.
Office: 120 West Second St.
Duluth, MN 55802
(218) 723-9200
FAX (218) 723-9223

David Komitau, Graphics Coordinator
Ted Matthews, Promotion Director
Office: 7500 Old Oak Blvd.
Cleveland, OH 44130
(216) 243-8100

EDGE
COMMUNICATIONS

Robert L. Edgell, Chairman; Richard Moeller, President; Lars Fladmark, Executive Vice President; Arland Hirman, Vice President/Treasurer; Thomas Greney, Senior Vice President; Ezra PinCUS, Senior Vice President; Joe Bilderbach, Vice President; James Gherna, Vice President; George Glenn, Vice President; Harry Ramaley, Vice President.

AURORA / SHADOW / BIGHORN

BRIGHT AND BEAUTIFUL IN THE SHADE

Aurora Hard Fescue, Shadow Chewings Fescue and Bighorn Sheep Fescue . . .
three shade and drought tolerant fine fescues for golf courses, parks, home lawns, roadsides and reclamation areas.

Aurora, Shadow and Bighorn have consistently topped fine fescue turf trials, and have years of 'experience' in low maintenance and high percentage shade areas.

These fescues mix well with perennial ryegrasses and Kentucky bluegrasses for use in sod production and golf courses; Aurora and Bighorn in the roughs and Shadow on the fairways.

When seeded in a monostand, our fescues will help give a course the 'Scottish links' look around tees

and in roughs, and blue-grey Bighorn adds another color dimension to course design.

Low growing Aurora, Shadow and even shorter growing Bighorn require less mowing, making them ideal for roadsides and other low maintenance areas.

All-in-all, when your turf area is in the shade, where water, nutrients and maintenance are costly, it'll pay you to look into Aurora, Shadow and Bighorn . . . the good look in fine fescues.

Aurora, Shadow and Bighorn qualify for Turf-Seed's blue tag incentive program. Write us or call your seed distributor for details.



Aurora PVP 8700070
Shadow PVP 8100155
Bighorn PVP Applied for

Produced and Marketed by



P.O. Box 250, Hubbard, OR 97032
503/981-9571
TWX 510-590-0957

CALL TOLL-FREE
OUTSIDE OREGON **800-247-6910**

It Stopped Just To Have Its P

You're witnessing a rare sight. Toro's Reelmaster® 450-D actually standing still. A rare sight because the Reelmaster 450-D is so dependable that it goes and goes and goes. Giving you the high capacity mowing and precise even cutting you've been looking for.



Each cutting unit is connected to a universal joint, so it can float freely in any direction, following the contour of the turf for an even, uniform cut. Or can be locked in a fixed position.



The Toro 450-D gives you protection against hydraulic fluid leaks. Wherever possible, hoses have been replaced with strong steel lines and O-ring seals protect connections. A hydraulic warning system flashes an alarm when the fluid level drops. For easy servicing, test ports for the hydraulic system are right on the side of the machine.

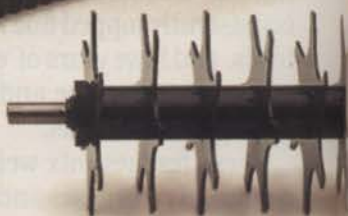

The Reelmaster 450-D can be customized with these accessories: ROPS, Cab, 5- and 7-bladed reels, rollers and thatching reels.

Long Enough Picture Taken.



Toro's exclusive variable clip control allows you to calibrate reel speed and mowing speed to give you the highest quality of cut in varying course conditions. Combine that with faster mowing speeds, up to 7.5 mph and 12.5 mph transport speed, and you're going to witness an increase in productivity. All controls are in easy reach of the operator to provide greater comfort.

The 450-D is designed with its weight evenly distributed around a center-mount 50 hp engine for better balance. This means more up-hill climbing ability than other machines and better traction.



Compared to tractor gang mowers, the Toro 450-D weighs less and is equipped with wide 31-inch tires that spread the weight for the lowest PSI, further minimizing turf marking.

For faster, easier mowing with more beautiful results, call your local Toro distributor for a demonstration of the Reelmaster 450-D or contact Toro at the address below. A machine built from the ground up with proven Toro design experience. And that translates into the kind of productivity no one can argue with.

TORO

The Professionals
That Keep You Cutting.

"Toro", and "Reelmaster" are registered trademarks of The Toro Company. ©1988 The Toro Company.

LANDSCAPE MANAGEMENT

TREES

Popular 'Treaty Oak' faces uphill struggle for survival

AUSTIN, Texas — The probable destruction of a 500-year-old oak tree has caused an outpouring of sympathy from 48 states and 18 countries.

"Cards and letters from all over the world cross my desk," says Austin city forester John Giedraitis. "They all have the same theme: get well soon."

Those affections, however, apparently have not been enough to save the venerable "Treaty Oak."

The tree rests in Caldwell Treaty Oak Park. Paul Cullen, an alleged occultist, is awaiting trial for its poisoning. He faces a possible sentence of up to 10 years in jail and a fine of up to \$10,000 for criminal mischief, a felony.

"All over the world, people are watching this," says Giedraitis, who—more than anyone—has been flooded with phone calls from newspapers, magazines and the electronic media. "Right now, this is the most famous tree in the world."

The tree's plight has been followed by the *New York Times*, *USA Today* and the Associated Press. Giedraitis himself has appeared on ABC-TV's "Good Morning America."

Unfortunately, the tree is dying a slow death.

Soil samples indicate a massive poisoning from an overdose of DuPont's Velpar herbicide, which penetrated as far as three feet under the soil surface.

Giedraitis has worked on advice from scientists at DuPont and tree experts from all over the country (including Dr. Jack Siebenthaler of the American Society of Consulting Arborists) to save the tree. Most recently, 18 irrigation heads that pump springwater around the crown were installed to sterilize the soil.

"Tissue samples indicate the level of poison going down," Giedraitis says, "but it's not going down fast enough. It's kind of like a race we're losing."

"The tree is dangerously close to the end, even though we really won't know until next spring."

He notes that tests indicate good starch reserves in the root system. "We're hopeful the carbohydrates will move up the stem into the remaining buds," he says.

More than \$63,000—most of it donated by billionaire industrialist H. Ross Perot—has been spent to save the massive tree. The total bill is expected to reach \$75,000, Giedraitis says.

The City of Austin bought the Treaty Oak from Earl Caldwell Sr. in 1937 with donations from the city's schoolchildren.

Since that time, Caldwell's Landscape Service Company has pruned it free of charge. The company is now under second-generation ownership.

The original Caldwell's

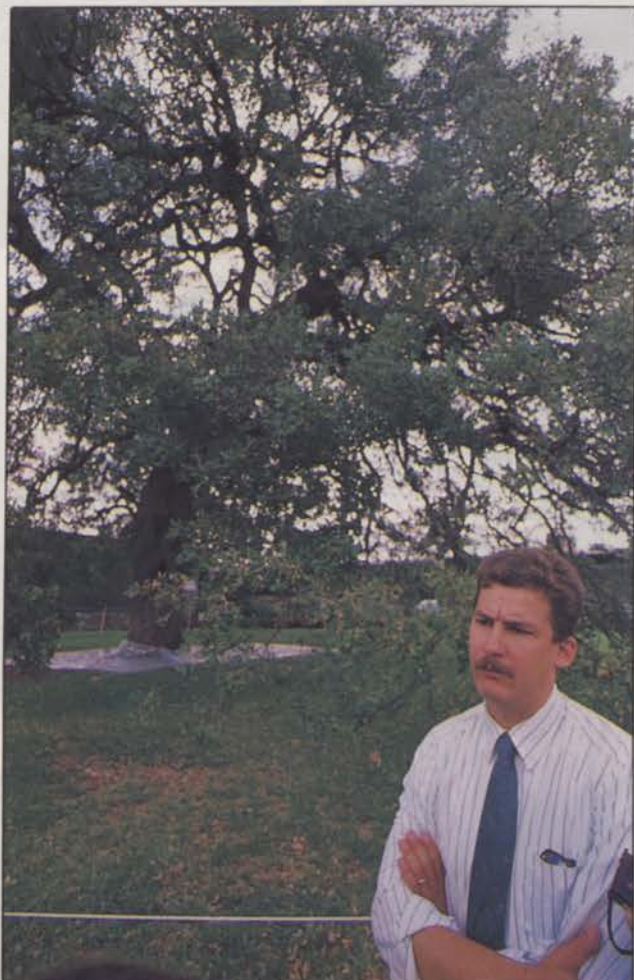

John Giedraitis has done everything possible to save the "Treaty Oak," an endangered Austin historical landmark. (Photo by Mike Boroff of the Austin Statesman-American)

son, Earl Jr., says he's kept his company out of the media spotlight because of its love for the tree.

"It's a very sad thing," notes Earl Jr. "It was a magnificent tree. Now it's dead, (the victim of) a demonic

act by a mentally deranged person."

Adds Giedraitis: "That shadowy figure sealed the fate of the tree. But the real story is the outpouring of love and affection by people all over the world." □



The Expedite system, shown here, eliminates almost all chances for accidents, according to landscapers who use it.

INDUSTRY

Biotech, safety are keys to 'good life'

ST. LOUIS — Biotechnology will play a bigger role in the lives of Americans and the green industry as they approach the year 2000.

This is how management at the Monsanto Company feels, according to Dr. Mike Montague, manager of research operations.

"Biotechnology is a quantum leap that ranks with the development of atomic and computer technology in this century," Montague told a group of reporters assembled at Monsanto's Chesterfield, Mo., research facility. "Biotechnology will have that kind of impact on our lives. And we

have bet the company on it."

Monsanto spent \$150 million to build its one million square foot facility that includes twenty-six 2600-square foot greenhouses.

"Congress and the administration is seeing that, for the U.S. to preserve its way of life, biotechnology

and other technologies are absolutely critical," Montague noted. "Total value of biotechnology-based products could easily be \$100 billion by the year 2000."

In keeping with its goal of producing environmentally-sound products, Monsanto came out with its

continued on page 18

INDUSTRY

Pesticide manufacturers to pursue lawn, landscape pros

FAIRFIELD, N.J. — Lawn care operators, golf course superintendents, landscapers and other professional turf managers are being vigorously pursued by pesticide and fertilizer manufacturers.

A recent study by C.F. Kline & Co. says manufacturers are being spurred on by profit incentives rather than market expansion or market size. Kline reports that 1988 sales to turf managers were about \$780 million, much lower than the total U.S. consumption of \$10 billion. However, sales to the specialty markets are contributing almost as much to company pro-

fitability due to lower development and selling costs.

Lawn care operators represent the industry's largest end-use segment, responsible for nearly 45 percent of fertilizer and pesticide sales. Golf course sales are second at 27 percent, and landscapers third at 11 percent (see chart), according to Kline & Co.

The report says competition will get stiffer, and acreage maintained by turf professionals will grow slowly. Manufacturers will increase sales only through the success of new products that chip away at competitors' market shares. □

**1988
U.S. CONSUMPTION OF
PESTICIDES AND FERTILIZERS
BY PROFESSIONAL TURF
MANAGERS**

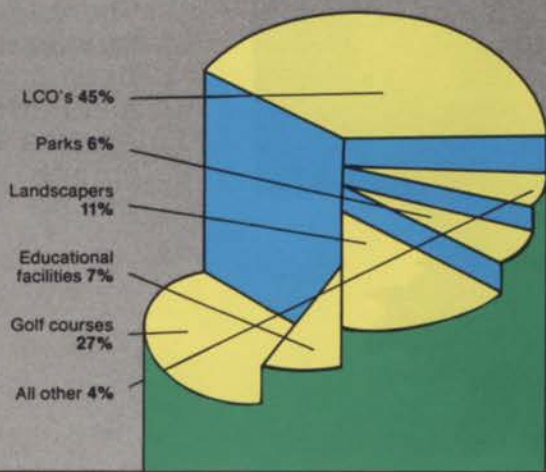





You can use Mavrik Aquaflow

Mavrik Aquaflow is the ideal insecticide/miticide for landscape maintenance.

It is a non-restricted product that is highly effective against the majority of insect and mite problems.

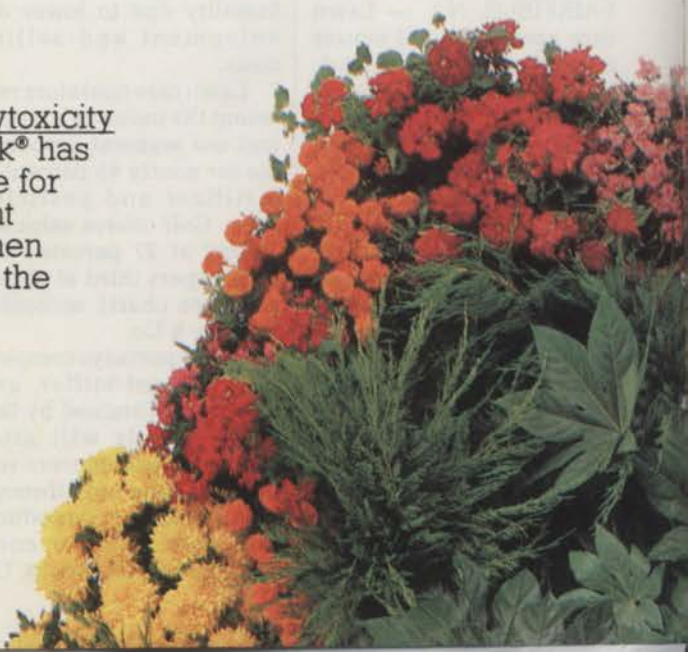

There are no phytotoxicity problems. Mavrik® has been proven safe for hundreds of plant species, even when sprayed right on the blooms.



flow[®] all over this page.



Mavrik is also very concentrated. So you have less to buy, carry around, or store. It's safe to use and Mavrik leaves no odor and little visible residue.

No matter what kind of insect and mite pests you come up against, hit them with Mavrik Aquaflow. And it'll be over for them.

See your distributor today.

SANDOZ CROP PROTECTION

Use pesticides effectively. Read and follow label directions carefully.
© 1987 Sandoz Crop Protection Corporation
Mavrik is a registered trademark of Sandoz, Ltd.

Circle No. 158 on Reader Inquiry Card



SHORT CUTS



Sure Is A Funny Looking Tee

It doesn't look like a tee, but in a way it's one of the best friends a golfer can have. Whether it's the fairway or the green, it's your job to provide and maintain the best playability for your golfers. Every golfer loves to walk up to that second shot and have the ball "teed up" on a lush green fairway. Every golfer looks for a true roll on the green.

Drift Reduction Is The Key

The Delavan Raindrop® nozzle helps you produce and maintain lush fairways and true greens. The Raindrop® is a wide-angle (120 degree), hollow-cone, drift-reduction nozzle.

- Driftable fines are reduced.
- The chemical goes where you want it.
- Larger orifice opening and passages minimize clogging.
- Color-coding makes selection and installation quick and easy.

Whether you are spraying insecticides, herbicides, fungicides, or fertilizer, the Delavan Raindrop® helps you maintain the type of playing surfaces your golfers expect.

Playability...that's what your job is all about. While our "tee" will never meet U.S.G.A. specifications, it will meet your specifications for even, controlled coverage that gives you the kind of fairways and greens you want. Choose the Raindrop®.

For the location of your nearest Delavan dealer, call toll free **1-800-621-9357**.

Colt Industries



Delavan

Agricultural Products Operation

Circle No. 119 on Reader Inquiry Card

AT LAST, AT LEAST...After years of bandying about a proposal that they unite for one large national conference and trade show, three of the green industry's top trade organizations have finally given the go-ahead. Last to embrace the idea was the Associated Landscape Contractors of America (ALCA), whose board of directors approved the plan in July. Also involved are the Professional Grounds Management Society (PGMS) and the Professional Lawn Care Association of America (PLCAA). The event is said to be proposed for October or November, 1990 in Nashville, Tenn.

TAKE HEED..."None of us has a crystal ball," notes industry consultant **Charles Vander Kooi**. But he's ready, via his newsletter, to do some predicting. "I feel that in 5 to 10 years, there will be 30 percent fewer companies in this business than there are today. This reduction in contracting firms will not be necessarily due to a poor economy. Rather, I feel it will be due to the fact that certain companies will become more advanced in their use of computers, more sophisticated in their estimating and job costing, and better managers of their businesses. As more companies become that way, they will take more of the available jobs away from those who are not advancing in the way they do their business."

BIO BOOM...Safer, Inc. reports that its sales of non-toxic, biodegradable pesticides more than doubled from April to June when compared to sales for the same period in 1988. And according to Safer's figures, yearly sales of non-toxic biodegradable pesticides by all manufacturers are now at almost \$31 million. "Biodegradability can be measured by examining the residual life of a product," says **Dr. Michael Atkins**, Safer's director of technical services and an entomology professor at San Diego State University. "The shorter the residual life, the more degradable the product."

NEW DIRECTIONS...The H.B. Musser Foundation, according to its president **Frank Dobie** of Sharon (Ohio) Country Club, is heading in new directions lately. "We're finally starting to put the concept of the Musser Foundation to work," he notes. "We've reorganized and have concentrated more on searching out more doctoral students for fellowships." He says the Musser Foundation, if it can increase its principal fund, hopes to eventually present multiple scholarships of \$10,000-\$12,000 each. "We're moving ahead," Dobie notes. For information on contributing to the foundation, call him at (216) 239-2383.

READ

...the fine print.

Net Weight 61 7/8 lbs

CAUTION: PLEASE KEEP OUT OF THE REACH OF CHILDREN. EYE CONTACT WITH CONTENTS MAY CAUSE IRRITATION. FLUSH EYES WITH WATER AS SOON AS POSSIBLE.

ProTurf Fairway Fertilizer 32-3-10 643-8408

Guaranteed Analysis

Total nitrogen (N)	32%
0.8% ammoniacal nitrogen	
24.5% urea, methylene urea nitrogen	
6.7% water insoluble nitrogen	
Available phosphoric acid (P ₂ O ₅)	3%

Scott's ProTurf

GUARANTEED ANALYSIS

Total Nitrogen (N)	30%
5.0% Water Insoluble Nitrogen	
0.0% Ammoniacal Nitrogen	
0.0% Urea Nitrogen	
Available Phosphoric Acid (P ₂ O ₅)	5%
Soluble Potash (K ₂ O)	9%
Magnesium (Mg)	10%
Sulfur (S)	0.0%
Iron (Fe)	1.0%
Manganese (Mn)	0.5%

Nutrient Sources: Urea, Methylene Ureas, Ammonium Phosphate, Ammonium Sulfate, Ammoniated Superphosphate, Sulfate of Potash, Oxides, Ferrous Sulfate, Sulfates.
Potential Acidity Equivalent 1000 lbs. Calcium Carbonate per Ton.

Lebanon Country Club

GUARANTEED ANALYSIS

TOTAL NITROGEN (N)	24.0%
1.6% Ammoniacal Nitrogen	
10.6% Urea Nitrogen	
10.8% Water Insoluble Nitrogen	
AVAILIBLE PHOSPHORIC ACID (P ₂ O ₅)	4.0%
SOLUBLE POTASH (K ₂ O)	12.0%
Magnesium (Mg)	0.7%
Sulfur (S)	5.0%
Iron (Fe)	0.4%

Derived from ammonium phosphate, isobutylidene diurea, urea, sulfate of potash, sulfate of potash-magnesia and iron sulfate. Potential Acidity 1000 lbs. Calcium Carbonate Equivalent per ton.
Manufactured by Vigoro Industries, Inc.
Fairview Heights, Illinois 62205.

Par Ex

Down in the analysis area on every fertilizer bag, you'll find the "fine print" that tells you what the big print doesn't. Read all of it. Carefully. But most importantly, look at the percentage of Water Insoluble Nitrogen.

Water Insoluble Nitrogen (WIN)... the key to superior turf.

The higher the WIN percentage, the longer your turf will remain green. And the less often you will have to fertilize. That's because WIN is the percentage of total Nitrogen that is truly slow release. Freeing small amounts of Nitrogen each time it's touched by water (Par Ex® with IBDU®) or activated by temperature or bacterial action (competitive products).

No competitor can deliver as much usable WIN as Par Ex.

Only Par Ex contains IBDU—a unique Water Insoluble Nitrogen source that is 100% available to your turf in a single growing season. Consider that urea formaldehyde products (bacteria and temperature released) contain about one third of their WIN in the form of plastic polymers. Its long-term Nitrogen

release is so slow, it's almost useless, and will most likely occur during the hottest periods, just when you don't want it.

For Sulfur Coated Urea (SCU), research has shown that by the time it is spread, about 50% is immediately soluble, effectively doubling your cost of controlled-release Nitrogen and cutting the benefit in half!

Be sure to read your bag.

If the percentage of Water Insoluble Nitrogen isn't listed, there isn't any slow-release Nitrogen. If it is listed, chances are it won't be as high as the WIN percentage in Par Ex. Even if it is, we guarantee you that 100% of what we list as WIN is available to your turf every growing season. That means for every six months of growing, you'll receive an additional 46-53% more usable WIN than our competitors can deliver.

So start building your WIN percentage today. Talk to your local Par Ex Representative or call 813/294-2567. And get all the WIN you've been reading about.



par ex
THE EX STANDS FOR EXCELLENCE



For a varie

Fiesta II

Perennial Ryegrass

This advance generation turf-type perennial ryegrass is setting new standards for quality, color, and performance. Its dark green color, fine leaf texture, and environmental tolerance gives you beautiful and functional results, while its high seed count stretches your grass seed dollar. Use Fiesta II straight or in Futura 2000 where it is blended with Blazer II and Dasher II perennial ryegrasses. A genetically superior combination for perennial turf in the North and overseeding in the South.

BANFF

Kentucky Bluegrass

Banff is a vigorous dwarf variety that was discovered on the Banff Springs Golf Course in Alberta, Canada. There, Banff survived twenty years of continual heavy watering, repeated attacks from snow mold, and close mowing on a putting green. Just imagine what it could do for you. Banff establishes quickly and forms a disease resistant, cold tolerant, dark green turf.

Touchdown

KENTUCKY BLUEGRASS

Since Touchdown's discovery by the late Tom Rewinsky on the National Golf Links of America on Long Island, this elite bluegrass has become the top choice of sod producers. Its aggressive growth habit and rapid establishment crowds out weeds and Poa annua while developing an even, dark green turf.



Mustang is the tall fescue that looks like bluegrass. Its finer texture, darker green color, and wear and drought tolerance have made it the choice for sports field, sod, park, and home lawn use. Mustang is available straight or in TEAM – a three-way turf-type tall fescue blend that also contains Maverick II and Thoroughbred.



Colt is an Oregon produced variety that offers you domestic seed production benefits. It combines superior turf performance and turf quality with genetic adaptation to North American growing conditions. It is dark green, shade tolerant, disease resistant, and very winter hardy. Colt is a vigorous, low-growing variety that has excellent overseeding qualities.



For the fourth consecutive year Victory was the highest rated commercially available chewing fescue in the national Fine Fescue Trials. Victory is a low growing, shade tolerant variety that has possibly the darkest green color of any other chewing fescue. It exhibits superior uniformity and disease resistance, too. If you like picking winners, pick Victory.

ty of reasons.



CROSSFIRE TURF-TYPE TALL FESCUE

Crossfire turf-type tall fescue is the only strategy you need for battling a summer ambush of heat and drought. Crossfire is a lower and slower growing variety of tall fescue that exhibits a very dark green color. It combines improved heat and drought tolerance with outstanding turf quality to produce a dense and durable turf. Crossfire's high marks in overall performance during its initial evaluation proved it was ready for the field. Let Crossfire show you how to endure a long summer siege.

SPARTAN HARD FESCUE

Spartan is a robust, advanced generation of hard fescue that is dark green, leafy, and persistent. It demonstrates excellent cold tolerance and creates attractive, low growing, low maintenance turf. Spartan mixes well with perennial ryegrass, Kentucky bluegrass, and other fine fescues. It is an outstanding component in many shady and low maintenance mixes suited for use on home lawns, parks, and golf course roughs.

AMERICA KENTUCKY BLUEGRASS

America is a low maintenance Kentucky bluegrass that has a dense dwarf growth habit, dark green color, excellent disease resistance, and good shade tolerance. Perfect in mixes, America is ideal for golf course fairways, sod production, playing fields, and home lawns.

Pickseed also produces the following quality turfgrass varieties: Agram chewing's fescue, Jasper creeping red fescue, Jazz perennial ryegrass, Alpine Kentucky bluegrass, Exeter colonial bentgrass, and National creeping bentgrass.

SHORTSTOP TURF-TYPE TALL FESCUE



Shortstop is the little guy with big benefits. As its name implies, Shortstop is a slower and shorter growing variety of turf-type tall fescue. But don't let its stature fool you. Shortstop is plenty tough. It has heat and cold tolerance, disease resistance and is widely adapted. Shortstop forms a beautiful, dense, uniform turf of finer, darker green leaves.

BRONCO Kentucky Bluegrass

Bronco is a very wide bladed Kentucky bluegrass that was developed specifically as a mix companion for turf-type tall fescue. While its texture and color gives it the appearance of a tall fescue, the comparison between the two ends there. Bronco is elite Kentucky bluegrass all the way. Its been bred to be less dense so it won't crowd out tall fescue and yet still aggressive enough to fill in and repair damaged areas quickly. That's what makes Bronco ideal for sports turf use.

Circle No. 151 on Reader Inquiry Card

Pickseed products are distributed throughout North America by quality seed suppliers.

PICKSEED®
PICKSEED WEST Inc.
P.O. Box 888 • Tangent, Oregon 97389
(503) 926-8886

Death claims Brickman Industries' founder Theodore Sr.

LONG GROVE, Ill. — The year 1989 has claimed its second landscaping giant with the death of Theodore W. Brickman Sr.

Brickman, founder of the award-winning Illinois-based landscape firm that bears his name, passed away at 82 years of age on Aug. 2. Though he had been inactive in the company for the last 15 years, he remained Chairman of the Board until his death.

The Brickman Group Ltd. bills itself as the country's largest design-build and horticultural management organization. It is now owned by Theodore "Dick" Brickman Jr.

"He was kind of a spiritual leader up until about a year ago," says Dick. "Even though he was largely inactive, there's still an emptiness."

The senior Brickman, a native of Ontario province,



T.W. BRICKMAN, SR.
1907-1989

Canada, founded the company in 1939. Though it was not in operation during World War II, it rebounded and blossomed in the 1960s and 1970s. Its seven offices now serve the Midwest and eastern corridor from Boston to Florida. The company has won more than 100 national, regional and local awards for its landscapes.

"From day one, he and I became equal partners," Dick remembers. "As a father, he was willing to step back and let us younger people take the reins. I hope I have as much wisdom when it's time to let the younger people in our organization step in for me."

Further remembering his senior, Dick notes: "(My father) lived a good, full, useful life and touched a lot of people."

Earlier this year, death claimed John Moulder, one of the founders of Moulder Brothers Inc., a California landscaping giant. □

BIOTECH from page 11

Expedite pesticide application system earlier this year.

"Expedite fits strategically into our philosophy," says Dr. Dave Duncan, director of greens business.

The Expedite system includes various herbicides and an exclusive "lance" manufactured in England which will be distributed worldwide by Monsanto.

"We believe we can reduce pesticide exposure (to the applicator) substantially," notes Monsanto district manager Jerry Steiner.

"And the hand-held unit is just the starting point."

Adds Dr. Duncan: "Expedite will fuel the (Monsanto) machine for more new products. It's very critical to our plans."

Landscape managers sold on Expedite include Vicki Phillips of the St. Paul (Mo.) Department of Parks and Recreation and Paul Norman of Washington University.

"Expedite is just amazing," Phillips says. "You hook it up, you put it on your back and you go." □

New

TURF TYPE TALL FESCUES

Now, more than ever, the choice of professionals and homeowners

Join the rapidly growing number who select Tall Fescue for:

- richer, darker, dense green turf
- requires low maintenance
- adaptable to a wide variety of soils
- achieves healthy, full growth in all normal climate conditions
- tolerance to heavy shade
- tolerance to heat and drought
- resistance to disease
- durability and longer wear
- year-round beauty and performance

Circle No. 150 on Reader Inquiry Card



Rich, green and luxurious Turf Type Tall Fescue gives you the beauty you want with a minimum of care. Excellent for play areas, parks, airfields, roadways, industrial sites and golf courses. Proven disease-resistant, Oregon Grown Tall Fescue seed produces an adaptable, weed-free turf that not only persists through summers and winters, but maintains its beauty. Insist on Turf Type Tall Fescue Seed grown in Oregon!

For more information
contact your seed dealer, or write to:

OREGON TALL FESCUE COMMISSION

866 Lancaster Dr. SE, Salem, Oregon 97301

Phone (503) 585-1157

**“My crew likes the way
our Hustlers ride,
but I love the way they mow.”**



Driver comfort is more than just a soft seat. Hustler drivers sit directly over the mower's pivot point. That means you don't experience the carnival ride motion you feel on rear steer and sulky mowers. The result is greater productivity and safety, and less operator fatigue.

Learning to operate the Hustler is easy. One hand is all it takes to maneuver a Hustler around any obstacle. Twin-lever controls are far less complicated than a steering wheel, gas, clutch and brake pedals, and gear shift. You can have anyone mowing like a pro in minutes, even if they've never operated commercial turf equipment before.

Hustlers cut grass as if your livelihood depends on it. Rugged Hustler mowers are built to withstand years of continual use. And the finished job will keep even the most finicky people smiling.

Buy Hustler for simple operation. For operator comfort, quality cut and unmatched maneuverability, you can't out-mow a Hustler. Call Excel toll free for a **FREE** Hustler Product Guide, or see your local Hustler dealer today.



The 18-hp Hustler 251K with 51" deck and 8-bushel BAC-PAC™ grass catcher.

— Featuring —
The Revolutionary New
TURBO SHREDDER™
DECK!

Excel Hustler...Still Out Front!

1-800-835-3260

(In Kansas and Canada 316-327-4911)

Excel Industries, Inc.

Hesston, KS 67062-2097



© 1988, Excel Industries, Inc.

Circle No. 126 on Reader Inquiry Card



Chickweed



Spurge

**Introducing
the fine art of
broadleaf weed control.
New Gallery.™**

Look closely. This may be the last time you'll see these broadleaves on display.

Elanco introduces the unique preemergence broadleaf weed control for golf courses. New Gallery 75DF. An original work of art. And science. With a new chemistry so advanced, it outdates postemergents, saving you time and labor costs.

The Gallery collection includes 44 of your toughest broadleaves such



White Clover

No Reproductions

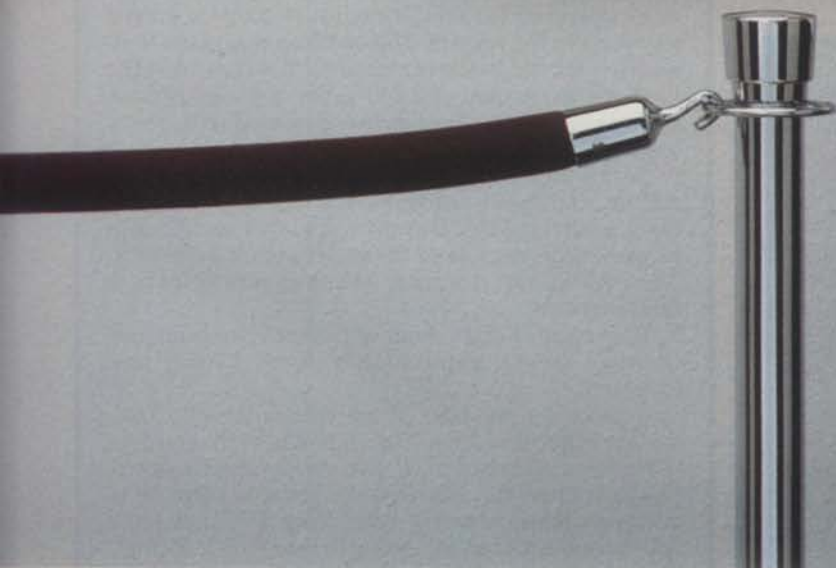

as spurge, chickweed and white clover. With no reproductions allowed.

All you'll see is masterpiece turf. Free from broadleaves. And free from injury. New Gallery is actually more tolerant to all major species of cool and warm season turf, including bentgrass, than other herbicides. And there's no risk of off-site damage to nearby ornamentals.

Discover the fine art of broadleaf weed control with new Gallery. See your Elanco distributor. Or for a free brochure, call toll-free: **1-800-352-6776.**

Elanco Products Company
A Division of Eli Lilly and Company
Lilly Corporate Center
Dept. EM-455, Indianapolis, IN 46285, U.S.A.
Gallery™—(isoxaben, Elanco)

Circle No. 124 on Reader Inquiry Card



NOW EPA REGISTERED.

The Choice Is Yours...



Whether you select grasses, legumes, wildflowers or ornamental plants to complete your landscape project, the new **PS100** mulch blanket from **PROSEED** can help vegetation get established. *Completely biodegradable*, the fibers of the **PS100** are bonded together by a high strength, flexible adhesive . . . no netting to affect the final appearance of your work or to bind up in mowers.

Each roll of **PS100** covers 50 square yards and the organic matrix of the blanket imparts excellent erosion control characteristics.

*So Choose Your Vegetation
and Relax*

**We've Gotcha
Covered!**



P.O. Box 1250
San Marcos, Texas 78667
(512) 392-1900

Circle No. 103 on Reader Inquiry Card

ATTACHMENTS PLUS™

Ground Maintenance Attachments for Tractors and Front Mowers.

The Choice of the Professional.

Landscapers, Municipalities, Schools, Cemeteries, Golf Courses. Serious grounds maintenance personnel with continuous

maintenance needs. They have all found *Attachments Plus* to be a practical solution to save time and money.



For complete details, call or write for a free color brochure.

Lawrence Inc.

15170 Hickory St. • Spring Lake, MI 49456
(616) 847-4200 • 1-800-872-4242

Circle No. 137 on Reader Inquiry Card

ATHLETIC TURF

STMA is ballooning

The Sports Turf Managers Association, which started out with just 64 members in 1984, is fast approaching the 1,000 mark in membership.

"Our renewal rate is 70 percent already this year and we're signing up about 10 new members a month," says executive director **Mark Hodnick**.

Hodnick, supervisor of landscape services at California Polytechnic University in Pomona, was named executive director to succeed **Dr. Kent Kurtz** earlier this year. The new arrangement is working out nicely.

"But the board of directors will soon have to consider having a full-time executive director," Hodnick notes. "We're just getting too big."

For more information on joining the STMA, write 400 North Mountain Ave., Upland, CA 91786 or phone (714) 981-9199.

Repairing Soldier Field

Soldier Field, home of the Chicago Bears, was supposedly ready for National Football League play on June 15, 1988. But the following month during a nationally-broadcast Bears-Miami Dolphins exhibition game, the grass began to tear, a result of poor rooting.

Ira Berke, director of landscape for the Chicago Park District, and **Jim Duggan**, landscape construction supervisor for the Chicago Park district, played key parts in the repairs. The decision was made to go with a thick sod in the center of the field between the hash marks. A total of 2,400 yards of 4½-inch thick sod was installed in four days and treated with heavy topdressing and aeration.

Berke and Duggan encountered two problems: soil interface and drought. "We had sod grown on black earth installed on top of sand. We had 42 days to work with, and 35 of those days were over 90°F. The roots and grass want to go dormant in those high temperatures."

Berke and Duggan dealt with those two problems through heavy topdressing, aeration and irrigation.

Berke liked the PAT (Prescription Athletic Turf) system's drainage advantage, but admits that no field is perfect. "When you're sold on the PAT system, you're sold on the idea that it's going to solve all of your problems, which it won't. Any field that gets a heavy amount of play is going to tear. The amount it tears depends on what kind of climate you're in."

1990 conference

The Sports Turf Managers Association's annual conference and show will be Jan. 19-21 in Houston, Texas. Theme is "Sports Turf: Heart of America in the 1990s;" keynoter is **Dr. Jim Watson** of the Toro Company.

For more information, contact the STMA at 400 Mountain Ave., Suite 301, Upland, CA 91786; phone (714) 981-9199.

Hot Iron

Uptime...all the time



Introducing the Ford C series. A new standard of uptime performance.

Hot Iron has it. Cold iron doesn't. Hot Iron protects your profits, and puts money in the bank. Cold iron takes the profit out of a job, and sends it down the drain.

The new Ford C series tractor loaders and tractor loader backhoes are built for profitable uptime performance, with more push, pull, lift, load, digging and staying power.

More push, pull and lift

New Ford loaders lower your cost per yard. With fully synchronized power-reversing transmissions, you get faster shuttling, with sure-footed stability.

Higher payload buckets and high output hydraulics cut bucket loading time.

New 8 x 8 transmission

If you're looking for a great landscape loader, look at the new model 455C. Equipped with a new 8x8 power-reversing transmission with torque converter, it's ready for any or all loading and landscaping jobs.

You get greater gear selection with ground speeds ranging from 1.5 to 20 mph . . . a full power independent PTO . . . and a torque converter lockup. With the torque converter lockup, you maintain constant ground speeds for grading, mowing, rototilling or roading.

A great place to work

Climb aboard one of these new operator platforms and experience the indus-

try's best design for operator comfort and convenience.

Low-effort, smooth-running controls are positioned so you'll work faster with less fatigue.

See your Ford Tractor dealer for a demonstration. He's listed in the Yellow Pages under "Contractor's Equipment & Supplies."

Find out how good a tractor loader can be.



We have our product

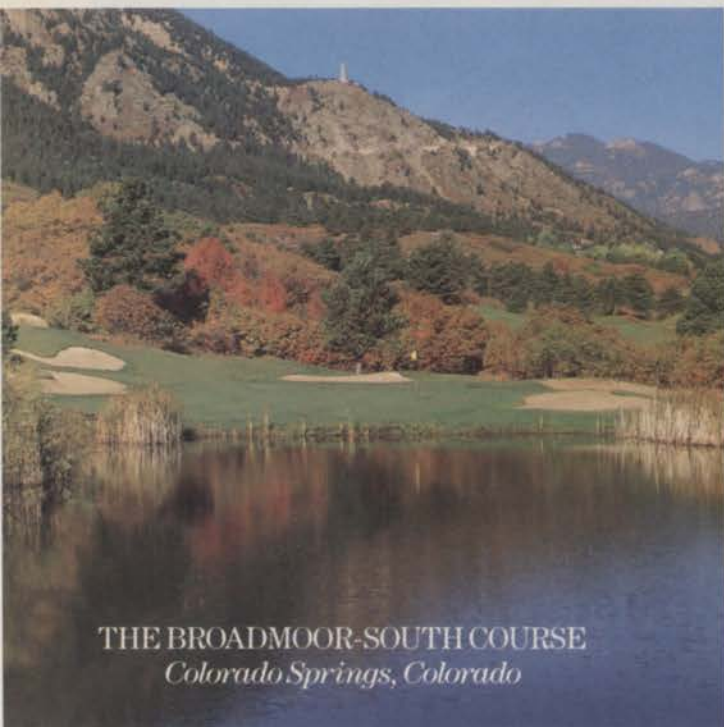

THE BROADMOOR-SOUTH COURSE
Colorado Springs, Colorado

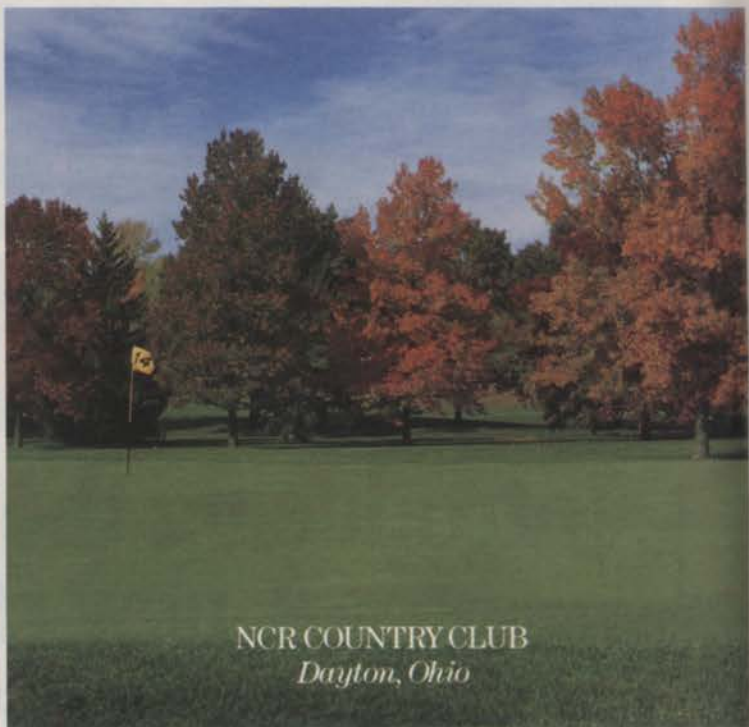

NCR COUNTRY CLUB
Dayton, Ohio

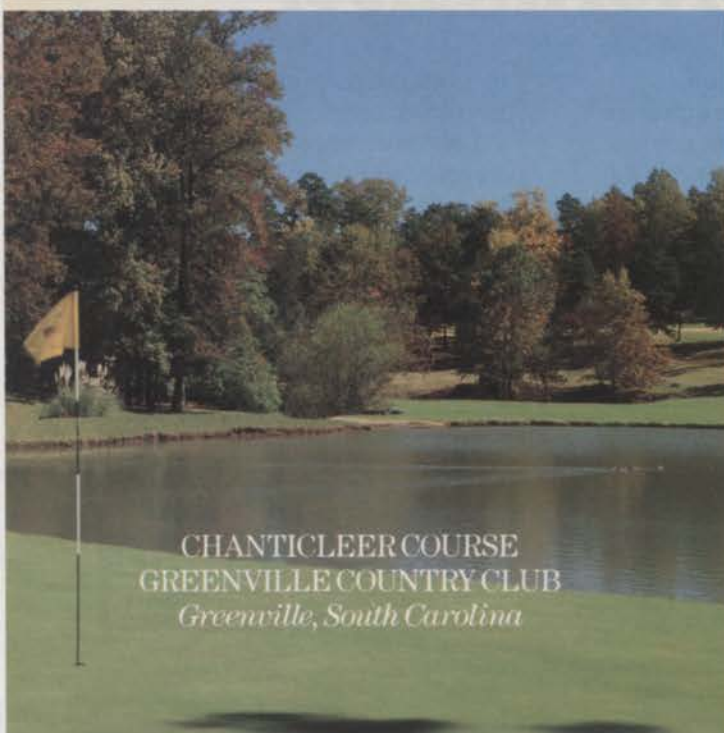

CHANTICLEER COURSE
GREENVILLE COUNTRY CLUB
Greenville, South Carolina

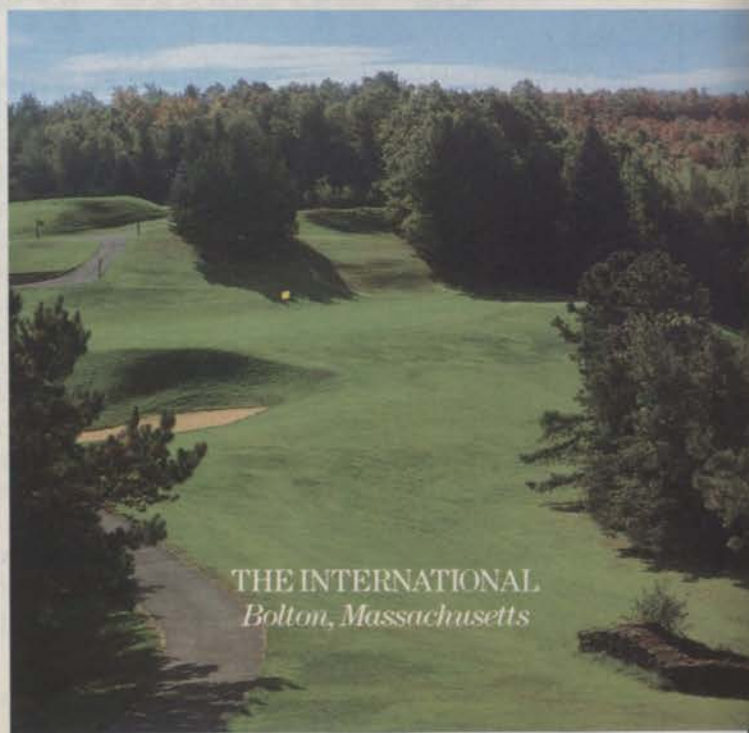

THE INTERNATIONAL
Bolton, Massachusetts

grounds for claims.

You've heard it before. "This stuff will get rid of your Poa annua. Blah, blah, blah, blah."

Well, Scotts TGR Poa Annua Control *will* help you get rid of your Poa. And we've got grounds to prove it.

Golf courses with tough Poa annua problems. And demanding superintendents. Over 2,000 courses, all over the country, are now using it successfully in their maintenance programs.

The result? Scotts TGR Poa Annua Control has lived up to its claims.

That's because Scotts patented TGR formulation contains paclobutrazol and is the only controlled-release, fertilizer-based Poa control product. The only product that halts the growth of Poa, then encourages the growth of desirable grasses to overtake it.

And since Scotts TGR Poa Annua Control is dry-applied, you get more even coverage, and less potential for volatility and chemical breakdown. So you can be assured of safe consistent results when used as directed.

Your Scott's Tech Rep can give you more facts and figures. Or you can just call us at 1-800-543-0006.

The only holes in our claims have flags in them.



TGR Poa Annua Control

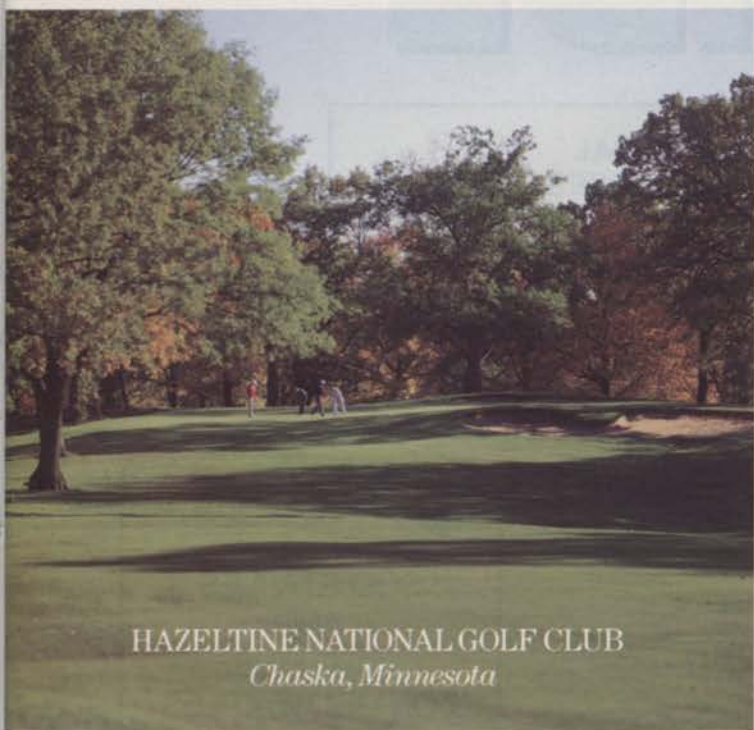

HAZELTINE NATIONAL GOLF CLUB
Chaska, Minnesota

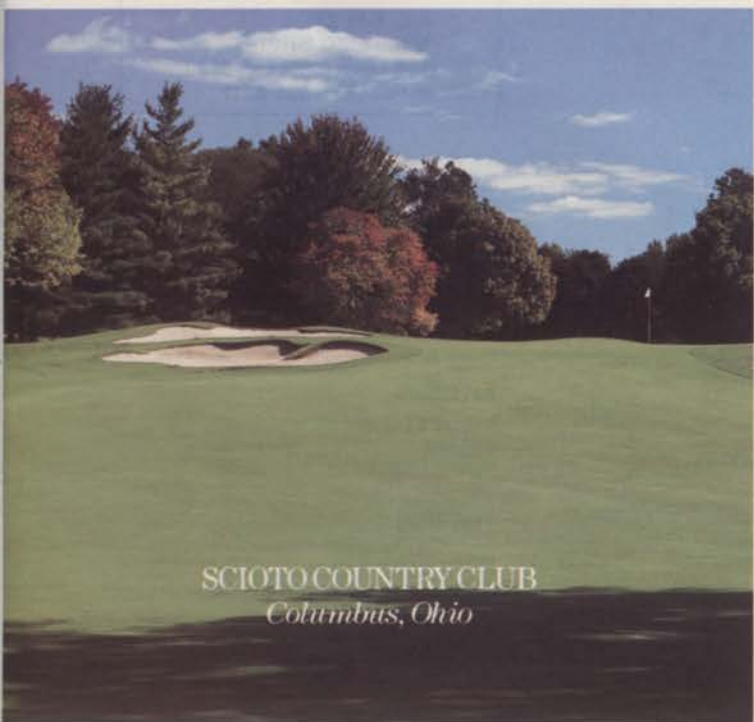

SCIOTO COUNTRY CLUB
Columbus, Ohio

BUYERS' GUIDE

EQUIPMENT _____	26	CHEMICAL COMPANIES _____	90
EQUIPMENT COMPANIES _____	58	SEED VARIETIES BY COMPANY _____	97
CHEMICALS _____	72		



1. Equipment

Aerators, Aquatic

Applied Biochemists Inc
Classen Mfg
Deere & Co
Giant-Vac Mfg Inc
Otterbine/Barebo Inc

Aerators, Soil

Aer-Way
BEFCO Inc
Brinly-Hardy Co
Howard S Crane Inc
Cushman
Dandi Mfg Co
Dedoes Industries Inc
Feldmann Engineering & Mfg Co
Fuerst Brothers Inc
Gandy Co
Green Care Intl
Green Pro Services
Hahn Inc
Hoffco Inc
Howard Rotavator Co
Jacobsen Div

JISCO
Johnson's Industrial Supply Co
F D Kees Mfg Co
LESCO Inc
Moyer & Son Inc
Olathe Mfg Inc
Professional Tree & Turf Equipment
Salsco Inc
Sensation Div
Snapper Power Equipment
Steiner Turf Equipment Inc
Tanaka Ltd
Terracare Products Co
Toro Co
Verti-Drain

Aerial Lifts

Arborchem Products Co
Hi-Ranger Inc
Promark Products Inc
Reach All Inc

Anchors, Earth

BASF Corp Fibers Div
A B Chance Co
Foresight Products Inc
Hoffco Inc
Mar-Mac Mfg Co

SEE AD NEXT COLUMN

Seymour Mfg Co

Aquatic Weed Harvesters

Air-Lec Industries Inc

Augers

Ariens Co
Ditch Witch
Feldmann Engineering & Mfg Co
Hoffco Inc



Mar-Mac Mfg Co., Inc.

SOD STAPLES
AND
SOD PINS
FOR GEOTEXTILES

P.O. Box 278
McBee, SC 29101
Toll Free: (800) 845-9692
In SC: (803) 335-8211

JISCO
Johnson's Industrial Supply Co
Kubota Tractor Corp
Little Beaver Inc
Melroe Co
Olathe Mfg Inc
Seymour Mfg Co
Solo Inc
Tanaka Ltd

Backfillers

Bomford & Evershed Ltd
Bush Hog
Ingersoll Equipment Co

Back Hoes

American Trencher Inc
J I Case Outdoor Power Equipment Div
Howard S Crane Inc
Deere & Co
Ditch Witch

It's

What's Below The Surface That Counts!



High Density Polyethylene Float:

Filled with US Coast Guard approved closed cell foam. Always floats level, stays afloat even if punctured or damaged. S/S fasteners provide longer life.

4 Pole/High Torque Motor:

Designed specifically for aeration. Runs longer and cooler at 1725 RPM. Easy to maintain. Rebuildable, not disposable.

Lubricating Oil:

Developed by a major oil company for lubricating and very low dielectric capabilities. Acts as heat transfer.

Power Control Center:

Exclusive Westinghouse motor controls provide maximum built-in protection. UL, CSA and ETL approved. Standard equipment, not an option.



Safety Tested:



All Otterbine aerators are safety tested and approved by ETL.

Circle No. 107 on Reader Inquiry Card

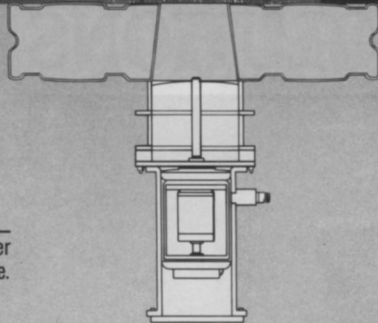

High Volume, Low Pressure Impeller:

Designed to aerate and move large volumes of water. Precision pitched Stainless Steel affords increased efficiency.

Plug-Type Underwater Connector:

Designed for Otterbine. Easy connect and disconnect makes installation and service simple.

Strong Distributor and Service Network:

Over 130 distributors nationwide with 35 service centers staffed by factory trained personnel.

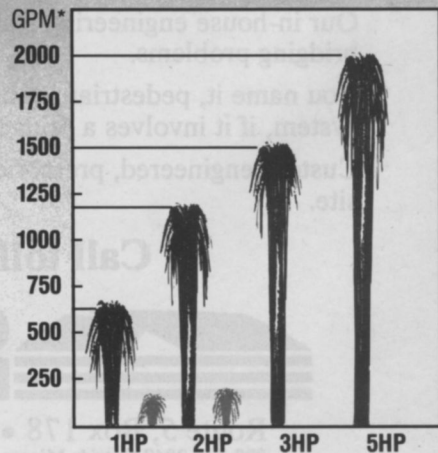

Otterbine Other Aerators
*Gallons Per Minute Pumped

BAREBO, INC.

P.O. Box 217, R.D. 2 • Emmaus, PA 18049 • Phone (215) 965-6018 • Fax (215) 965-6050

Equipment

continued

Ford New Holland Inc
Ingersoll Equipment Co
Kioti Tractor Inc
Kubota Tractor Corp
Massey-Ferguson Inc
Melroe Co
Woods Div

Benches

American Playground Corp
BigToys
Outdoor Products & Supply Inc
Playworld Systems
Standard Golf Co

Blades, Mower, etc

Bolens Corp
Bomford & Evershed Ltd
Bush Hog
Earl J Crane Inc & Assocs
Cushman
Dandl Mfg Co
Deere & Co
Deutz-Allis Corp
Hoffco Inc
Kubota Tractor Corp
Lawn-Boy Inc
LESCO Inc
Magic Circle-Dixie Chopper
Massey-Ferguson Inc
Omark Industries
Power Lawnmower Parts Inc
Scag Power Equipment Inc

Blades, Dozer/Scraper

American Trencher Inc
Ariens Co
Bolens Corp
Bomford & Evershed Ltd
Bush Hog
J I Case Outdoor Power Equipment Div
Earl J Crane Inc & Assocs
Howard S Crane Inc
Deere & Co
Deutz-Allis Corp
Ford New Holland Inc
Grasshopper Co
Grazer Div Willsey-D
Kubota Tractor Corp
Lawrence Inc
Massey-Ferguson Inc
Simplicity Mfg Inc
Steiner Turf Equipment Inc
Waldon Inc
Westendorf Mfg Co
Wheel Horse Products Inc
Woods Div

Bleachers

American Playground Corp

Blowers

Ariens Co
Atwater Strong Inc

Billy Goat Industries



**BILLY
GOAT**
INDUSTRIES, INC.

P.O. Box 308
Lee's Summit, MO 64063-0308
Phone: (816) 524-9666
Fax: (816) 524-6983

Bunton Co
Howard S Crane Inc
Cushman
Deere & Co
DOB Distributors Inc
Finn Corp
Forestry Suppliers Inc
Giant-Vac Mfg Inc
Green Machine
Hoffco Inc
Homelite Div
Jacobsen Div
Maruyama US Inc
Olathe Mfg Inc
Roto-Hoe Co
Shindaiwa Inc
Snapper Power Equipment
Solo Inc
Steiner Turf Equipment Inc
Tanaka Ltd
Toro Co
Westheffer Co
Yard Vac Products Inc

Bridges

Continental Bridge
Western Wood Structures Inc

Brush Cutters, Hand Held

Ames Co
Ariens Co
Bunton Co
Deere & Co
DOB Distributors Inc
Forestry Suppliers Inc
Green Machine
Hoffco Inc
Homelite Div
Maruyama US Inc
Seymour Mfg Co
Shindaiwa Inc
Seymour Smith & Son Inc
Snapper Power Equipment
Solo Inc
Tanaka Ltd
Westheffer Co
Yazoo Mfg Co

Brush Cutters, Right-of-Way

Bomford & Evershed Ltd
Bush Hog
Howard S Crane Inc
Forestry Suppliers Inc
Ingersoll Equipment Co
Kinco Mfg
Mathews Co
R L Parsons & Son ECI aka Micro-Mower Co
Rousseau
Royer Foundry & Machine Co
Seymour Smith & Son Inc
Woods Div

Bucket Lifts

Arborchem Products Co
Bomford & Evershed Ltd
Lawrence Inc
Reach All Inc

BRIDGING SOLUTIONS



Our in-house engineering staff is ready to help you solve your bridging problems.

You name it, pedestrian, vehicular, pipe support, conveyor system, if it involves a bridge—we can do it!

Custom engineered, prefabricated and delivered to your job site.

Call toll free today!



Route 5, Box 178 • Alexandria, MN 56308
800-328-2047 Outside Minnesota • 800-572-7002 Inside Minnesota
612-852-7500 Outside U.S.A.

Circle No. 112 on Reader Inquiry Card

A letter of apology from Cushman.



A Division of Outboard Marine Corporation
P.O. Box 82409, Lincoln, Nebraska 68501-9971 • Phone: (402) 475-9581 • FAX: (402) 474-8522 • Telex: 484359

Dear Golf Course Superintendent:

We hold ourselves responsible for a large area aerator you may have recently purchased that, in all honesty, does not live up to the highest level of quality you deserve. We apologize for not having the new Cushman® GA60 Large Area Aerator available for the fall aeration season. We're sorry, because the GA60 quite simply offers greater value and performance than any other competitive large area aerator on the market today.

If you have not yet purchased a large area aerator, we encourage you to wait a few months. Because if you wait, we won't feel badly...and neither will you.

You'll be able to purchase a Cushman Turf-Truckster™ and a GA60 for about the same money that our competitor asks for their tractor-pulled reciprocating fairway aerator alone.* The GA60 has its own power source for more consistent quality. And, it features the coring heads of the proven Ryan GA30, delivering higher quality holes for greens-caliber aeration.

The GA60's unique 5th wheel configuration also gives you less soil compaction, a zero turning radius while aerating, and quick attachment and detachment — no mechanical alterations or gear replacements are required.

Cushman GA60's have been undergoing rigorous field-testing for nearly a year now, and they'll be demonstrated in many parts of the country this fall. Be watching for a demonstration in your area.

I'm confident that once you see the new Cushman GA60, you'll agree that it was well-worth the wait.

Sincerely,

A handwritten signature in dark ink, appearing to read "Frank McDonald".

Frank McDonald
Marketing Director

P.S. If you'd like more details on the Cushman GA60 Large Area Aerator, just call toll free 1-800-228-4444.

*Based on August '89 price survey.

© Cushman Division of Outboard Marine Corporation, 1989. All rights reserved.

Equipment Companies

continued

Strong Mfg Co
Westendorf Mfg Co

Carts, Lawn

Ames Co
Brinly-Hardy Co
Country Mfg Inc
Earl J Crane Inc & Assocs
Howard S Crane Inc
Deere & Co
Falkenberg Inc
Ingersoll Equipment Co
Kadco Inc
Precision Products Inc
Simplicity Mfg Inc
Westheffer Co
Wheel Horse Products Inc

Chain Saws

Ariens Co
Deere & Co
Fairmont Hydraulics
Forestry Suppliers Inc
Green Machine
Homelite Div
Progressive Power Tools Corp
Shindaiwa Inc
Solo Inc
Stanley Hydraulic Tools
Tanaka Ltd

Chain Saw Parts

Deere & Co
Homelite Div
Power Lawnmower Parts Inc
Solo Inc
Tanaka Ltd

Chippers

Arborchem Products Co
Arbortech/A Scott Fetzer Co
Badger Chipper Co
Chipmore Mfg Co
Howard S Crane Inc
Forestry Suppliers Inc
Heckendorn Mfg Co
Jacobsen Div
Lindig Mfg Corp
Morbark Industries Inc
Olathe Mfg Inc
Promark Products Inc
Roto-Hoe Co
Royer Foundry & Machine Co
Vermeer Mfg Co

Cultivators

Aer-Way
Ames Co
Ariens Co
BEFCO Inc
Bolens Corp
Bomford & Evershed Ltd
Bush Hog
Deere & Co
Feldmann Engineering & Mfg Co
Gravely Intl Inc
Green Machine
Hoffco Inc
Homelite Div
Howard Rotavator Co
Lawn-Boy Inc
LESCO Inc
Solo Inc
Tanaka Ltd
Vicon Farm Machinery Inc

Dethatchers

Ames Co
Ariens Co
BlueBird Intl
Brinly-Hardy Co
Brouwer Turf Equipment Ltd

Bunton Co
J I Case Outdoor Power Equipment Div
Earl J Crane Inc & Assocs
Howard S Crane Inc
Cushman
Deere & Co
Deutz-Allis Corp
Exmark Mfg Co
Fuerst Brothers Inc
Goossen Industries
Gravely Intl Inc
Hahn Inc
Hoffco Inc
Howard Rotavator Co
F D Kees Mfg Co
Kinco Mfg
Olathe Mfg Inc
Roseman Mfg Co
Salsco Inc
Snapper Power Equipment
Tanaka Ltd

Disease Detection Kits

LESCO Inc

Dozers

Bomford & Evershed Ltd
Howard S Crane Inc
Deere & Co
Deutz-Allis Corp
Komatsu Dresser

Drainage Tubing

A C F Inc
Advanced Drainage Systems Inc
Atlantic Construction Fabrics Inc
Cambridge Soil Services of America Inc
Hancor Inc
LESCO Inc

Drills

Ariens Co
Bush Hog
Hoffco Inc
JISCO
Johnson's Industrial Supply Co
Little Beaver Inc
Olathe Mfg Inc
Stanley Hydraulic Tools
Strong Enterprises Inc
Tanaka Ltd

Dusters

B & G Equipment Co
Forestry Suppliers Inc
Green Machine
Maruyama US Inc
Professional Tree & Turf Equipment
Southern Mill Creek Products Co
Strong Enterprises Inc
Trebort Corp
Westheffer Co

Edgers

Ames Co
Ariens Co
Bunton Co
Earl J Crane Inc & Assocs
Curb King
Deere & Co
Excel Industries Inc
Green Machine
Hoffco Inc
Homelite Div
Jacobsen Div
LESCO Inc
Scag Power Equipment Inc
Snapper Power Equipment
Steiner Turf Equipment Inc

Tanaka Ltd
Toro Co
Turfco Mfg Inc
Wheel Horse Products Inc

Edging, Lawn

A C F Inc
Earl J Crane Inc & Assocs
Deere & Co
Eberhart Steel Products Plastic Div
Green Machine
Oly-Ola Sales Inc

SAFE LANDSCAPE EDGINGS

- 5 styles to choose from
- References nationwide
- Fastest shipping time
- Safe for all playgrounds, & running tracks
- Guaranteed quality & competitive pricing
- Quantity pricing for distributors & wholesalers

CALL FOR YOUR NEAREST DISTRIBUTOR

Phone: 312-833-3033 • (outside Illinois) 1-800-EDGINGS
Fax 312-833-0816 (344-4647)

Oly-Ola Sales, Inc.

148 W. St. Charles Road • Villa Park, Illinois 60181

Permaloc Aluminum Edging

PERMALOC® ALUMINUM EDGING

Flexible Heavy Gauge
No Rusting or Cracking
Reduces Maintenance
Permanent Clean Look

WHY SETTLE FOR LESS?
Call 1-800-356-9660

Engine Parts

Briggs & Stratton Corp
Earl J Crane Inc & Assocs
Cushman
DOB Distributors Inc
Hoffco Inc
Kiotti Tractor Inc
Power Lawnmower Parts Inc
Professional Tree & Turf Equipment
Strong Enterprises Inc
Tecumseh Products Co



THE CHOICE OF LEADERS

Strong.
Dependable.
Always ready.
Constantly challenging the future.
Searching for better ways.
The symbol of performance.
Power. Precision.
Quiet. Enduring.
The trusted leader.

Onan
Engines



5 - 12.5 hp Single Cylinder Elite



16 - 24 hp Twin Cylinder Performer

Onan Corporation • 1400 73rd Avenue N.E.
Minneapolis, Minnesota, USA 55432

Telephone: 612-574-5000 • Telex 275477 • Cable ONAN

Circle No. 261 on Reader Inquiry Card



All signs point to a hassle-free cleanup season

Debris never falls where you want it. That's the hassle. And that's why it makes sense to have debris cleanup machines that can work anywhere. Machines like the John Deere 142, 152, and 162 Vacuum Sweepers.

All three work equally well on turf or pavement because they don't have wear parts beating the ground. They use vacuum power.

A heavy-duty steel impeller is the key. It creates tremendous suction and can handle everything from leaves and clippings to cans and bottles—actually crushing and mulching the material before it goes into the hopper.

The 142 and 152 are engine-powered, so they can be used with any tractor 20 horsepower or above. The 142 clears a 4-foot swath while the 152 eats up 5 feet of debris on every pass.

The PTO-driven 162 also clears a 5-foot swath and requires a 40 horsepower tractor. And, like the 142 and 152, you can empty the hopper without leaving your seat.

Talk to your John Deere distributor today for more information on all we have to offer. Or write John Deere, Dept. 956, Moline, IL for free literature. We know you're going to like what you see.

John Deere vacuums work equally well on turf or pavement because they have no wear parts beating the ground.



John Deere blowers, like the 3-point hitch mounted 230, fit well into any cleanup operation.



Nothing Runs Like a Deere®



Circle No. 118 on Reader Inquiry Card

Equipment

continued

Teledyne Total Power
Wheel Horse Products Inc

Engines

Briggs & Stratton Corp
Earl J Crane Inc & Assocs
Cushman
Deere & Co
DOB Distributors Inc
Ford New Holland Inc
Honda Power Equipment
Kawasaki Motors Corp USA Engine Div
Kiotti Tractor Inc
Kohler Co
Kubota Tractor Corp
Lawn-Boy Inc
Lombardini USA Inc
Onan Corp

Onan's Performer series of two cylinder engines includes 16, 18, 20 and 24 HP horizontal shaft models and 16, 18, and 20 HP vertical shaft models. Features include electronic ignition, solenoid shift starter and full pressure lubrication.

Onan recently expanded its engine line with the addition of the single cylinder Elite series. The 12.5 HP vertical shaft model is currently in production and future models will include 5-12.5 HP horizontal and vertical crankshaft configurations.

ONAN CORPORATION

1400 73rd Avenue • Minneapolis, MN 55432
(612) 574-5000

Professional Tree & Turf Equipment
Professional Turf Mfg
Robco USA Inc
Strong Enterprises Inc
Tecumseh Products Co
Teledyne Total Power
Tufflex Mfg Co
Westheffer Co

Erosion Control Blocks

A C F Inc
Atlantic Construction Fabrics Inc
Eberhart Steel Products Plastic Div
Hydro Turf & Assoc
Presto Products Co

Erosion Control Fabric

A C F Inc
Akzo Industrial Systems Co
Atlantic Construction Fabrics Inc
BASF Corp Fibers Div
Conwed Fibers
Dewitt Co
E I DuPont de Nemours & Co
Jonathan Green Inc
Hoechst Celanese Corp
Hydro Turf & Assoc
North American Green Inc
Phillips Fibers Corp
Reemay Inc
Warren's Turf Nursery Inc
Weyerhaeuser Co

Fertilizer Injectors

Arborchem Products Co
Doggett Corp
Inject-O-Meter Mfg Co
LESCO Inc
J J Mauget Co
Nature's Touch
Professional Tree & Turf Equipment
Smith Precision Products
Vaughan's Seed Co

Filters, Sand

Claude Laval Corp
Morie Co

Foggers

B & G Equipment Co
Falkenberg Inc
Southern Mill Creek Products Co
Westheffer Co

Forklifts

Bomford & Evershed Ltd
Brouwer Turf Equipment Ltd
Deere & Co
LESCO Inc
Raymond Corp
Teledyne Princeton
Waldon Inc

Generators

Ariens Co
Earl J Crane Inc & Assocs
Howard S Crane Inc
Deere & Co
Dyna/ENERGX Corp
Fairmont Hydraulics
Homelite Div
Honda Power Equipment
Kawasaki Motors Corp USA
Kubota Tractor Corp
Onan Corp
Shindaiwa Inc
Tanaka Ltd
Winco/Energx Corp

Geotextiles

A C F Inc
Advanced Drainage Systems Inc
Atlantic Construction Fabrics Inc
BASF Corp Fibers Div
Dewitt Co
Jonathan Green Inc
Hydro Turf & Assoc
Phillips Fibers Corp
Reemay Inc
Warren's Turf Nursery Inc

Golf Cars

Club Car Inc
Columbia ParCar Corp
E-Z-GO Textron
Melex USA Inc
Noland Car Co
Professional Turf Mfg
Trojan Battery Co

Golf Course Accessories

J A Cissel Mfg Co
Earl J Crane Inc & Assocs
LESCO Inc
Outdoor Products & Supply Inc

OUTDOOR PRODUCTS & SUPPLY, INC.

.....
*Manufacturer of
Golf Course Products*
.....

3924 Orchard Road
Cleveland Heights, OH 44121
1-800-331-7907 — National
1-800-331-7898 — Ohio

Standard Golf Co
Vaughan's Seed Co

Grass Pavers

Golf 2000 Corp
Hydro Turf & Assoc
Presto Products Co

Hose & Reels

Agrotec Inc
Ames Co
Anchor Swan
Arborchem Products Co
Falkenberg Inc
Friend Mfg Corp
Green Pro Services
Hahn Inc
Hannay Reels
Hydro Turf & Assoc
LESCO Inc
Maruyama US Inc
Professional Tree & Turf Equipment
Professional Turf Mfg
Robco USA Inc
Southern Mill Creek Products Co
Spraying Devices Inc
Strong Enterprises Inc
Tufflex Mfg Co
Westheffer Co

Irrigation Systems & Supplies

AMETEK Inc/Plymouth Products Div
Aquaopore Moisture Systems
Bloch & Co
Buckner Irrigation
Earl J Crane Inc & Assocs
Franklin Electric
Gardenamerica
Hunter Industries
Kalo Inc
LESCO Inc
Moisture Systems Professional Irrigation Div
Motorola Control Systems
Nalco Chemical Co
Outdoor Products & Supply Inc
Progressive Electronics Inc
Rain Bird Sprinkler Mfg



**Rain Bird
Sales, Inc.**
PREFERRED BY
PROFESSIONALS WORLDWIDE

THE WORLD LEADER
IN WATER MANAGEMENT,
OFFERING A COMPLETE LINE
OF INNOVATIVE IRRIGATION PRODUCTS.

For More Information
Call our
Toll Free Number
1-800-999-1229 ext. 305

Standard Oil Engineered Materials Co
Submatic Inc
Toro Co
Toro Co Irrigation Div
Weather-matic

Lighting Systems

LESCO Inc
Otterbine/Barebo Inc
Rain Bird Sprinkler Mfg

If These Nationals Climbed Hills any Better They'd Have Four Legs, Two Horns & Live in the Rockies!



See for yourself why there's nothing as nimble on any turf as a National Triplex. Call today for a FREE video.

(612) 646-4079



NATIONAL MOWER COMPANY

SINCE 1919

700 Raymond Avenue
St Paul, Minnesota 55114
FAX (612) 646-2887

Equipment

continued

Toro Co
Wheel Spray Corp

Litter Receptacles

Friend Mfg Corp
Outdoor Products & Supply Inc
Playworld Systems
Standard Golf Co

Loaders

Billy Goat Industries



Bomford & Evershed Ltd
Bush Hog
J I Case Outdoor Power Equipment Div
Howard S Crane Inc
Deere & Co
Deutz-Allis Corp
Ditch Witch
Engineering Products Co
Ford New Holland Inc
Giant-Vac Mfg Inc
Grazer Div M & W Gear Co
Ingersoll Equipment Co

Kioti Tractor Inc
Kubota Tractor Corp
Massey-Ferguson Inc
Melroe Co
Olathe Mfg Inc
Salsco Inc
Steiner Turf Equipment Inc
Strong Mfg Co
Thomas Equipment Ltd
Waldon Inc
Westendorf Mfg Co

Loading Ramps

American Road Equipment Co
Giant-Vac Mfg Inc
Magline Inc
Melcher Mfg Co
Salsco Inc

Log Splitters

Bush Hog
J I Case Outdoor Power Equipment Div
Howard S Crane Inc
Forestry Suppliers Inc
Ingersoll Equipment Co
Mid Dakota Corp
Morbark Industries Inc
Vermeer Mfg Co

Markers, Field

Forestry Suppliers Inc
LESCO Inc
Outdoor Products & Supply Inc
Precision Laboratories Inc

Richway Industries Ltd

**TURF
MARKER™**
— Since 1973 —
A Must For Spraying
Parks, Golf Courses & Cemeteries
FOAM SPRAY PATH INDICATOR
Highly Visible • Economical
Toll Free 800-553-2404
In Iowa 319-987-2976
Richway Industries
Jamesville, IA

Spectrum Technologies Inc
Westheffer Co

Measuring Wheels

Forestry Suppliers Inc
Gandy Co
Imler Industries Inc
LESCO Inc
Nature's Touch
Professional Tree & Turf Equipment
Professional Turf Mfg
Strong Enterprises Inc

Mist Blowers

Agrotec Inc
Arborchem Products Co
Forestry Suppliers Inc

The Heavyweight Hauler.

E-Z-GO's gas-powered GXT-1500 is a real workhorse packed with hauling power, carrying two passengers and up to 1,500 pounds. Its extra long bed holds 19 cubic feet, and has removable sides and tailgate for easy loading. For on-the-spot maintenance, the GXT-1500 has a tilt dash, tilt seat and dump body, so that every part of its new, sturdy, more powerful, 20 horsepower, two-cylinder engine is within easy reach. With easy adaptability to virtually every type of turf accessory available, the GXT-1500 tackles the task whatever the terrain, whatever the need. Unquestionably, the toughest turf vehicle on earth. And that's just one of the full team of dependable, three and four wheel, gas and electric utility vehicles from E-Z-GO. The toughest, most versatile turf vehicles going.

NOBODY BUILDS THEM BETTER.

EZGO **TEXTRON**

E-Z-GO Division of Textron Inc.

P.O. Box 388, 1451 Marvin Griffin Road, Augusta, Georgia 30913-2699

Circle No. 265 on Reader Inquiry Card

It's a Sure Bet The World's Top Courses Aren't Cutting with a National Mower Because It's Pretty!



Discover why National Triplexes are the 1st Choice of the world's top turf professionals. Call today for a FREE video.

(612) 646-4079



NATIONAL MOWER COMPANY

SINCE 1919

700 Raymond Avenue
St Paul, Minnesota 55114
FAX (612) 646-2887

Equipment

continued

Friend Mfg Corp
Green Machine
Homelite Div
Maruyama US Inc
Solo Inc
Strong Enterprises Inc
Trebtor Corp
Westheffer Co

Moisture Sensors

Forestry Suppliers Inc
Westheffer Co

Mower Accessories

Bolens Corp
Bunton Co
Earl J Crane Inc & Assocs
Cub Cadet Commercial Mowers
Danville Industries
Deere & Co
Deutz-Allis Corp
Excel Industries Inc
Grazer Div M & W Gear Co

Power Lawnmower Parts Inc
Scag Power Equipment Inc
Simplicity Mfg Inc

Mower Parts

Bolens Corp
Earl J Crane Inc & Assocs
Cub Cadet Commercial Mowers
Dandl Mfg Co
Deere & Co
Deutz-Allis Corp
Excel Industries Inc
Jacobsen Div
Kiotti Tractor Inc
Lawn-Boy Inc
LESCO Inc
Power Lawnmower Parts Inc
Scag Power Equipment Inc

Rousseau
Toro Co
Woods Div
Yazoo Mfg Co

Mowers, Reel

Brouwer Turf Equipment Ltd
Bunton Co
Earl J Crane Inc & Assocs
Deere & Co
Jacobsen Div
Kubota Tractor Corp
LESCO Inc
Locke Mfg Inc
National Mower Co
Howard Price Turf Equipment
Ransomes Inc
Roseman Mfg Co
Steiner Turf Equipment Inc
Toro Co

Mowers, Rotary

Ariens Co
BEFCO Inc
Bolens Corp
Bunton Co
Bush Hog
J I Case Outdoor Power Equipment Div
Earl J Crane Inc & Assocs
Howard S Crane Inc
Cub Cadet Commercial Mowers
Cushman
Deere & Co
Deutz-Allis Corp
DewEze Mfg Inc
Dixon Industries Inc
Excel Industries Inc



**GRAZER DIVISION
M & W GEAR CO.**

The Pinnacle of Excellence

Gibson City, IL 60936

800-221-2855 800-252-5807

Heckendorn Mfg Co
Homelite Div
Lawn-Boy Inc
LESCO Inc

Mowers, Flail

BEFCO Inc
Bomford & Evershed Ltd
Brillion Iron Works Inc
Bush Hog
Dandl Mfg Co
Deere & Co
Ford New Holland Inc
Gravelly Intl Inc
Jacobsen Div
Kubota Tractor Corp
Mathews Co
Middlesworth Engineering & Mfg Inc
MoTrim Inc
R L Parsons & Son ECI aka Micro-Mower Co

THE CHOICE OF PROFESSIONALS

Promark tree- and turf-related products have become the standard in the landscaping/grounds maintenance industry.

Across the Country, municipalities, arborists, golf courses, landscape contractors and tens of thousands of other grounds care specialists have come to rely on Promark equipment for unsurpassed performance and cost savings, combined with unique engineering and safety features.

Over the past decade, most professionals seeing a Promark demonstration have become buyers, and then repeat customers. You owe it to yourself to see the best equipment in the industry in action. Ask an owner. He'll tell you "nothing equals a Promark."

**P PROMARK
PRODUCTS INC.**
330 9th Avenue, City of Industry, CA 91746
Telephone: (818) 961-9783
FAX: (818) 961-2307

Model 1050
Turf & Pavement Vacuum



Model R18
Root & Stump Grinder



Model 310
Limb & Brush Chipper



Models PAL 34 and PAL 40
Trailer Lift



If You Knew How Little it Costs To Buy & Run a National You Wouldn't Buy any Other Triplex!



Before you make a final purchase,
check the true value National
Mowers offer. Call today for a FREE video.

(612) 646-4079



NATIONAL MOWER COMPANY

SINCE 1919

700 Raymond Avenue
St Paul, Minnesota 55114
FAX (612) 646-2887

Circle No. 146 on Reader Inquiry Card

Equipment

continued

Exmark Mfg Co



Ford New Holland Inc
Giant-Vac Mfg Inc
Grasshopper Co
Gravelly Intl Inc
Grazer Div M & W Gear Co
Grazer Div Willsey-D
Heckendorn Mfg Co
Homelite Div
Honda Power Equipment
Ingersoll Equipment Co
Jacobsen Div
F D Kees Mfg Co
Kioti Tractor Inc
Kubota Tractor Corp
Kut-Kwick Corp
Lawn-Boy Inc
LESCO Inc
Magic Circle-Dixie Chopper
Massey-Ferguson Inc
Middlesworth Engineering & Mfg Inc
MoTrim Inc
Howard Price Turf Equipment
Ransomes Inc
Sarlo Power Mowers Inc

Scag Power Equipment Inc
Sensation Div
Simplicity Mfg Inc
Snapper Power Equipment
Steiner Turf Equipment Inc
Toro Co
Vicon Farm Machinery Inc
Walker Mfg Co



Wheel Horse Products Inc
Woods Div
Yazoo Mfg Co

Mowers, Sickle Bar

Earl J Crane Inc & Assocs
Deere & Co
Ford New Holland Inc
Gravelly Intl Inc

Kinco Mfg
Massey-Ferguson Inc
MoTrim Inc

Mulchers, Hydraulic

Bowie Industries Inc
Finn Corp
Hydro Turf & Assoc

WHY YOU SHOULD BUY HYDRO-TURF'S 1200



Models from 300 - 5000 gallons

THE MODEL 1200 IS THE MOST ADVANCED SEEDER/MULCHER EVER DEVELOPED!

- LOWER PROFILE - 1100 Gallons
- 40 HP KABOTA DIESEL (Lower Operating Cost)
- MECHANICAL PADDLE & JET AGITATION
- CENTRIFUGAL PUMP (240 GPM/100-150 PSI)
No High Maintenance Gear Pumps
- LOWER MAINTENANCE (No Gear Boxes, Shaft Seals, Chains, Sprockets, Hydraulic Pumps, Motors)
- FULL PORT BALL VALVES (Little or No Clogging)
- EASIER LOADING (Direct Truck to Unit Access)
- 500# MULCH LOADING
- 10 Cu. Ft. TOOL BOX
- MULTI USE SPRAYER (Watering, Tree & Turf Care)
- VERSATILITY
- LOWER COSTS

Dealer and Salesman Inquiries Invited

EROSION CONTROL TECHNOLOGIES
HYDRO-TURF & ASSOC.

160 W. INDUSTRIAL DR. GILBERTS, IL 60136
312-551-1555 800-798-8873

Reinco Inc

Netting

A C F Inc
Atlantic Construction Fabrics Inc
J A Cissel Mfg Co
Dewitt Co
Jonathan Green Inc
Hydro Turf & Assoc

Nozzles & Accessories

Agrotec Inc
Arborchem Products Co
Buckner Irrigation
Delavan
Encap Products Co
Falkenberg Inc
Green Pro Services
Hypro Corp
LESCO Inc
Na-Churs Plant Food Co
Nature's Touch
Outdoor Products & Supply Inc
Professional Tree & Turf Equipment
Professional Turf Mfg
Rain Bird Sprinkler Mfg
Spraying Devices Inc
Strong Enterprises Inc
Toro Co Irrigation Div
Trebort Corp
Tuflex Mfg Co
Westheffer Co

GET SERIOUS ABOUT HYDRO-MULCHING

Bowie Industries invented the Hydro-Mulcher.® And whether you specialize in large or small projects, Bowie makes a Hydro-Mulcher that will save you money. The Bowie Victor 800 is ideal for lawn and landscape jobs.



service. Its 800 gallon tank can easily spread 350 pounds of mulch over 8,000 square feet in one application. The Bowie Victor 800 is equipped with a built-in shredder bar, and uses twin agitators

to keep slurry homogeneous. Call or write Bowie today. We make serious equipment for serious landscapers.



BOWIE INDUSTRIES, INC.

P.O. Box 931, Bowie, Texas 76230
Toll-Free: 1-800-433-0934 ■ In Texas: 1-817-872-2286 ■ Telex: 887844

Hydro-Mulcher® is a registered trademark of Bowie Industries, Inc.

Circle No. 108
on Reader
Inquiry Card

For the long run.



Introducing a powerful new force in riding rotary mowers.

Now there's more to Cushman® Front Line® Mowers than top cutting performance. More power. More operator comfort. More endurance.

Now there's the new diesel-powered model Cushman 807.

Its totally integrated power train and new hydraulically-powered steering gives you unmatched performance over the long run. The 807 dispatches thick, wet grass on tricky maneuvers around obstacles without losing

ground speed. No other rotary mower gives you a cleaner cut.

At the heart of the new, four-wheel 807 is a powerful 21.5 horsepower, 3-cylinder Kubota 950 diesel engine. We've also included a heavy-duty Donaldson air cleaner and a new, heavy-duty Cushman PTO clutch to keep your new Cushman Front Line running longer. A complete family of Cushman Front Lines and a wide range of accessories are available to meet all your needs all

year 'round. Choose a 3 or 4 wheel design with 60- or 72-inch side or rear discharge mower deck. Or add the exclusive Cushman Grass Caddy™ system, which lets you cut, catch, and hydraulically dump 16 bushels of clippings without leaving the seat.

For a convincing demonstration contact your Cushman dealer today. Or call toll-free: 1-800-228-4444.

CUSHMAN®
BUILT TO LAST

3457 Cushman, OMC-Lincoln, P.O. Box 82409, Lincoln, NE 68501

© Outboard Marine Corporation, 1987. All rights reserved.

Circle No. 115 on Reader Inquiry Card

Equipment

continued

Picnic Tables

American Playground Corp
Playworld Systems
Seymour Mfg Co

Pipe

Hancor Inc
LESCO Inc
Professional Turf Mfg
Westheffer Co

Play Structures

American Playground Corp
BigToys
Oly-Ola Sales Inc
Playworld Systems
Western Wood Structures Inc

Plows, Sand Trap

Toro Co

Post Hole Diggers

Ames Co
BEFCO Inc
Bush Hog
Howard S Crane Inc
Deere & Co
Fairmont Hydraulics
Feldmann Engineering & Mfg Co
Ford New Holland Inc
Forestry Suppliers Inc
Gravelly Intl Inc
Hoffco Inc
Kubota Tractor Corp

Massey-Ferguson Inc
Melroe Co
Mid Dakota Corp
Seymour Mfg Co

Pressure Gauges

Arborchem Products Co
Encap Products Co
Falkenberg Inc
Green Pro Services
Hypro Corp
LESCO Inc
Na-Churs Plant Food Co
Outdoor Products & Supply Inc
Professional Tree & Turf Equipment
Professional Turf Mfg
Robco USA Inc
Strong Enterprises Inc
Tuflex Mfg Co
Westheffer Co

Pruners, Hedge

Ames Co
DOB Distributors Inc
Forestry Suppliers Inc
Green Pro Services
Seymour Smith & Son Inc

Pruners, Tree

Ames Co
DOB Distributors Inc
Fairmont Hydraulics
Fanno Saw Works
Forestry Suppliers Inc
Friend Mfg Corp
Green Machine

Green Pro Services
LESCO Inc
Seymour Smith & Son Inc
Stanley Hydraulic Tools

Pumps

Agrotec Inc
Arborchem Products Co
Ariens Co
Berkeley Pumps
Bowie Industries Inc
Earl J Crane Inc & Assocs
Falkenberg Inc
Friend Mfg Corp
Green Pro Services
Homelite Div
Honda Power Equipment
Hydro Turf & Assoc
Hypro Corp
Kubota Tractor Corp
LESCO Inc
Maruyama US Inc
Na-Churs Plant Food Co
Otterbine/Barebo Inc
Professional Tree & Turf Equipment
Professional Turf Mfg
Robco USA Inc
Shindaiwa Inc
Solo Inc
Spraying Devices Inc
Stanley Hydraulic Tools
Sta-Rite Industries Inc
Strong Enterprises Inc
Tanaka Ltd
Tuflex Mfg Co
Westheffer Co
Winco/Energx Corp

The Growing Choice

Hydrograssers & Power Mulchers



- Low Maintenance Design
- Dual and Quad "Hydro-Jet"
- Agitation with Verticle Homogenizers
- High Speed Mulch Grinder
- No Clog Mulch Chamber
- Direct Drive

Reingo Hydrograssers and Power Mulchers offer you the dependability you need because they are designed with the operator in mind. Our Hydrograssers range in capacity from 800 to 3500 gallons and feature easier to maintain "Hydro-Jet" agitation. Reingo Power Mulchers utilize time proven straight through drive while the M80C offers as standard a variable speed automated bale feed system.

Reingo

P.O. Box 512, Plainfield, N.J. 07061-0512 (201) 755-0921

WRITE OR CALL TOLL FREE (800) 526-7687

Dealer inquiries invited.

Circle No. 157 on Reader Inquiry Card

The details show that even as Bunton mowers improve they still remain the same.

In these days of a highly competitive grounds maintenance industry, with many look-alike products, it's no longer good enough to simply say you're the best. You have to prove it. That's why it's more important than ever to examine the details before making your mower investments.

Bunton Company was founded on the belief that quality should never be compromised when engineering a commercial mower. As new features are added, it is done in the same tradition that has helped Bunton mowers maintain their integrity on the job year after year for over thirty years. Take a close look at the others and you'll find that the Bunton details really do make the difference.



BUNTON

Heavy gauge welded steel deck, handles and casters on Bunton mowers assure integrity and long life.

The larger output shaft pulleys on Bunton mowers increase the top ground speed by up to 20%, and for optimized mowing performance, ground speed can be changed while mowing, without changing the blade and engine speed.

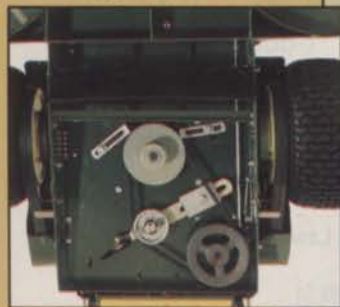

Bunton 36", 48", 52" and 61" mowers feature dual section V-belts for improved belt life due to decreased slippage under wet conditions.



Self-adjusting idlers lock into position for steady running on ball bearings.



Straight V-belts are wrapped without twists or back-bends on Buntons for increased belt life.

The Bunton details make the difference.

BUNTON

BUNTON CO.

P.O. Box 33247
Louisville, KY 40232
Phone: 502-966-0550
Fax: 502-966-0564

Discover the Grasshopper Advantage



Efficiency Expert!

New Gemini hydrostatic direct drive, with smooth "natural" controls, distinctive outfront design, and zero-turn-radius maneuverability give you the ultimate in time-cutting performance and value.

Become more efficient. Get the most from your grounds maintenance dollars. Count on the new 700 Series from Grasshopper. The new Gemini direct drive brings new standards of time-saving productivity, lower maintenance costs and long-lasting durability to turf care.

Operation is streamlined and simple. A dual-lever control system reduces fatigue by placing total command of speed, turns, braking and forward/reverse in the palm of your hand. Zero-turning-radius and outfront decks eliminate wasted motion. You can turn on a dime, reach under low-hanging trees and shrubs, maneuver between and around obstacles and trim close with unrestricted visibility.

The bottom line...Grasshopper delivers lasting value that meets the test of time — time after time!



For year-round versatility, add Quik-D-Tatch® vacuum grasscatchers for clippings or leaf pickup, a dozer blade, rotary broom, snowthrower, ROPS and cab enclosure.

Grasshopper mowers are available in six models, from 11 to 21 hp, with cutting widths from 35 to 72 inches.

Ask your Grasshopper Dealer to demonstrate why Grasshopper is the best value in a hydrostatic zero-turn-radius mower. Write for free literature.

The Grasshopper Company
1 Grasshopper Trail • P.O. Box 637 • Moundridge, KS 67107
Telephone 316-345-8621 • Telex 5106017571 • FAX 316-345-2301



OUTFRONT SINCE 1970

GRASSHOPPER

YOUR NEXT MOWER

©1989, The Grasshopper Company

Circle No. 130 on Reader Inquiry Card

Equipment

continued

Rakes, Landscape

Ames Co
Earl J Crane Inc & Assocs
Howard S Crane Inc
Ford New Holland Inc
Forestry Suppliers Inc
Glenmac Inc
Jacobsen Div
LESCO Inc
Mathews Co
Outdoor Products & Supply Inc
Standard Golf Co
Yard Vac Products Inc

Rain Sensors

Forestry Suppliers Inc
Rain Bird Sprinkler Mfg
Spectrum Technologies Inc
Toro Co Irrigation Div

Rock Pickers

Howard S Crane Inc
Ford New Holland Inc
Glenmac Inc
KEM Enterprises Inc

**ROCKHOUND
LANDSCAPE RAKE**

**A SERIES
ROCKHOUND**

Dumping

Skid Steer Mount (Hydraulic) 3 Point Mount

COST EFFECTIVE ROCKHOUNDS

Rake and collect rocks and surface debris, leaving the soil in a fluffy, level, seed-bed quality condition.

It does not cost to own a Rockhound. . . IT PAYS!

1-800-426-5615

KEM ENTERPRISES, INC.
18425 Eighth Ave. S.W.
Seattle, WA 98166

Terracare Products Co

Rollers, Lawn

Ames Co
Brinly-Hardy Co
Brouwer Turf Equipment Ltd
Howard S Crane Inc
Cushman
Gandy Co
Westheffer Co
Wheel Horse Products Inc

Rope

Allied Products Inc
Forestry Suppliers Inc

ANNOUNCING

LDW

A BREAKTHROUGH IN COMPACT, LIQUID COOLED DIESEL TECHNOLOGY

LDW signals a new lineup of engines from Lombardini and a new era in liquid cooled diesel technology. LDW includes both the full overhead control system (FOCS) and compact, heavy duty (CHD) engines, each of which sets new standards for economical, liquid cooled diesel performance.

Each of these smooth running engines is completely original, beginning with the design, and both offer the ultimate in low vibration, quiet operation and economy.

The FOCS series houses all critical components in the cylinder head to ensure minimum dimensions and easy installation and maintenance.

FROM LOMBARDINI

An indirect fuel injection system uses unit pump injectors rather than the traditional, separate components. This eliminates fuel lines and allows the FOCS to deliver optimum precision of fuel delivery throughout the performance curve.

Overall engine noise is minimized by the use of a heavy duty, toothed belt camshaft drive.

A choice of two, three or four cylinder in line configurations let you match FOCS power to your exact needs.

Our CHD also features indirect fuel injection. Using specifically designed individual fuel injection

pumps, maximum accuracy of fuel delivery is ensured at all speeds.

Multi-cylinder configuration, reduced unitary displacement and liquid cooling make the CHD ideal for use in applications where operator comfort is of the highest concern.

Power ranges are 12-22 hp for the FOCS and 25-48 hp for the CHD.

Specific fuel consumption is just 0.42 lbs/hp/hr., the lowest of any small, indirect injected diesel. Excellent torque backup of 15% at 60% of maximum rated load means you'll have the power you need, when you need it.

The new liquid cooled lineup from Lombardini: advanced power for your toughest applications.

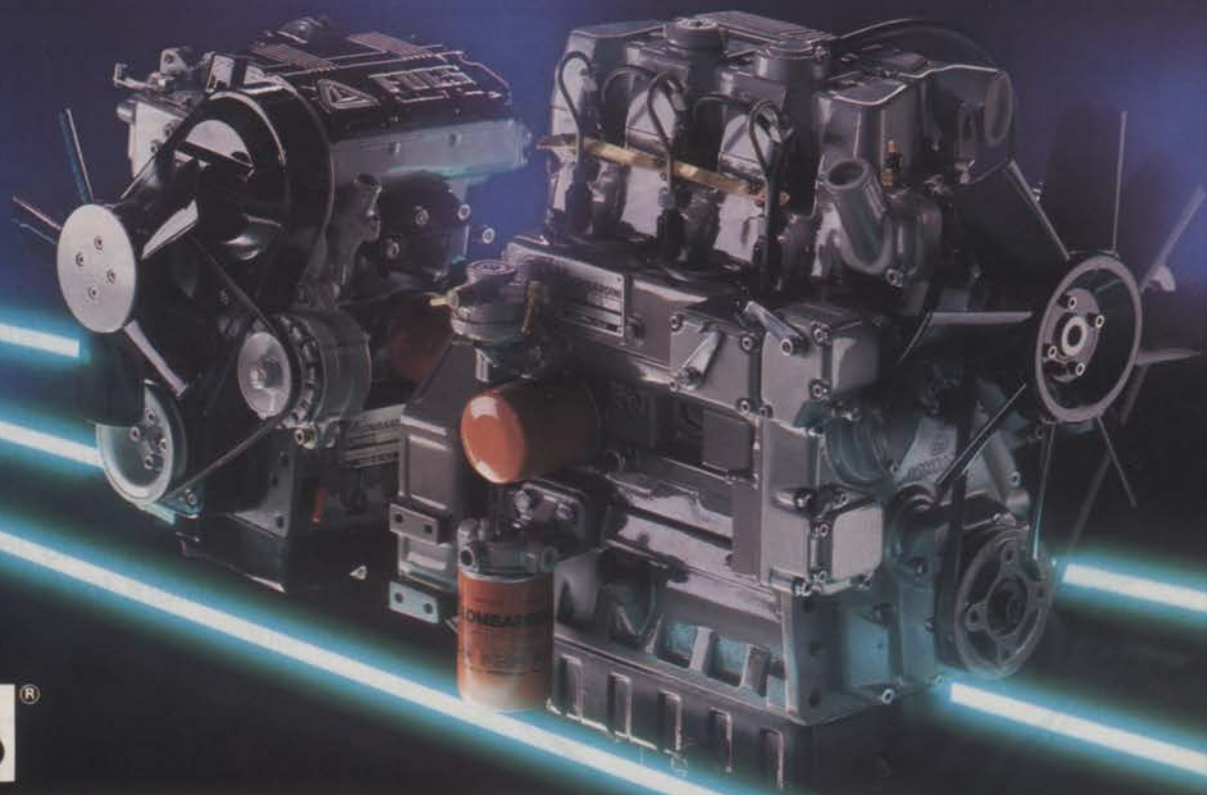

LOMBARDINI USA, INC.

601 Old Norcross Place, Suite E,
Lawrenceville, GA 30245
(404) 963-4881 FAX(404) 995-1107

Circle No. 290 on Reader Inquiry Card

Equipment Companies

continued

LESCO Inc
Outdoor Products & Supply Inc
Power Lawnmower Parts Inc
Standard Golf Co

Safety Wear & Equipment

Arborchem Products Co
Encon Safety Products
Forestry Suppliers Inc
LESCO Inc
3M Occupational Health & Environmental Safety Products Div
Moyer Products Inc
Outdoor Products & Supply Inc
Precision Laboratories Inc
Professional Tree & Turf Equipment
Shindaiwa Inc
Westheffer Co

Saws

Fanno Saw Works
Forestry Suppliers Inc
Green Machine
LESCO Inc
Progressive Power Tools Corp

Scrapers

Ames Co
Bomford & Evershed Ltd
Deere & Co
Kubota Tractor Corp

Screeners

Earl J Crane Inc & Assocs
Lindig Mfg Corp

Royer Foundry & Machine Co

Seeders

Aer-Way
Ames Co
BEFCO Inc
BlueBird Intl
Brillion Iron Works Inc
Brinly-Hardy Co
Brouwer Turf Equipment Ltd
Bush Hog
Earl J Crane Inc & Assocs
Cushman
Deere & Co
Finn Corp
Forestry Suppliers Inc
Great Plains Mfg
Green Pro Services
Hahn Inc
Hendrix and Dail Inc
Herd Seeder Co
Hydro Turf & Assoc
Jacobsen Div
LESCO Inc
Maruyama US Inc
Olathe Mfg Inc
Salsco Inc
Seymour Mfg Co
Thompson Seeder Co
Vicon Farm Machinery Inc

Seeders, Hydraulic

Bowie Industries Inc
Finn Corp
Hydro Turf & Assoc

WHY YOU SHOULD BUY HYDRO-TURF'S 1200



Models from 300 - 5000 gallons

**THE MODEL 1200 IS THE MOST ADVANCED
SEEDER/MULCHER EVER DEVELOPED!**

- LOWER PROFILE - 1100 Gallons
- 40 HP KABOTA DIESEL (Lower Operating Cost)
- MECHANICAL PADDLE & JET AGITATION
- CENTRIFUGAL PUMP (240 GPM/100-150 PSI)
No High Maintenance Gear Pumps
- LOWER MAINTENANCE (No Gear Boxes, Shaft Seals, Chains, Sprockets, Hydraulic Pumps, Motors)
- FULL PORT BALL VALVES (Little or No Clogging)
- EASIER LOADING (Direct Truck to Unit Access)
- 500# MULCH LOADING
- 10 Cu. Ft. TOOL BOX
- MULTI USE SPRAYER (Watering, Tree & Turf Care)
- VERSATILITY
- LOWER COSTS

Dealer and Salesman Inquiries Invited

EROSION CONTROL TECHNOLOGIES

HYDRO-TURF & ASSOC.

160 W. INDUSTRIAL DR. GILBERTS, IL 60136
312-551-1555 800-798-8873

Reinco Inc

THE NEW STANDARD IN OVERSEEDING AND INITIAL SEEDING



America's finest turf seeder is built in America by the finest name in grain drills, Great Plains Manufacturing. The metering and placement systems are tailor-made for turf grass seeds, while optional knife spacings are available in 2", 3" and 4" centers for seeding productivity.

LAND PRIDE

CALL OR WRITE FOR COLOR LITERATURE.

P.O. BOX 218 • ASSARIA, KS 67416
913-667-4755

Circle No. 131 on Reader Inquiry Card

All in a day's work...

for the Brouwer™ turf maintenance team.



1. 5 or 7 Gang Hyd. Lift P.T.O. Mowers

The team to make easy work of your turf maintenance program. For golf courses, school boards, municipalities, highway, parks and recreation departments, airfields and landscapers, there is a Brouwer product for you.

Brouwer builds rugged dependability and superior quality into every product, and that means value - not only when you buy but also in the "second to none" after sales service that will keep your machinery down-time low, and you happy to have Brouwer on your side. Check these outstanding products, from the rugged, economical mowers, the high capacity Brouwer Vac to the turf renovating team of the Sod Cutter MK2 and one of those turf rollers, no matter, the Brouwer team can fit the bill... and your budget.



2. Hydraulic lift for easy transport or storage



3. Triplex 376-A™



4. Sod Cutter MK.2™



5. Large Capacity Brouwer-Vac™



6. Turf Rollers 130, 224 & 235



7. 5 Gang Vertical Mower

Dollar for dollar, feature for feature...no competition.

For a live or Video demonstration of Brouwer products contact your area Brouwer dealer... TODAY

Woodbine Ave., Keswick,
Ont., Canada L4P 3E9
Tel. (416) 476-4311
Fax. (416) 476-5867

BROUWER™
TURF EQUIPMENT LIMITED
An Outboard Marine Corporation Company

7320 Haggerty Rd.,
Canton, MI. 48187
Tel. (313) 459-3700
Fax. (313) 459-8778

Equipment

continued

Sharpeners

Earl J Crane Inc & Assocs
Forestry Suppliers Inc

Shears

Ames Co
DOB Distributors Inc
LESCO Inc
Seymour Smith & Son Inc

Snow Blowers

Ariens Co
Bolens Corp

J I Case Outdoor Power Equipment Div
Earl J Crane Inc & Assocs
Howard S Crane Inc
Cub Cadet Commercial Mowers
Cushman
Deere & Co
Deutz-Allis Corp
Excel Industries Inc
Ford New Holland Inc
Grasshopper Co
Gravely Intl Inc
Grazer Div M & W Gear Co
Grazer Div Willsey-D
Green Machine
Hoffco Inc

Homelite Div
Honda Power Equipment
Ingersoll Equipment Co
Jacobsen Div
Kioti Tractor Inc
Kubota Tractor Corp
Lawn-Boy Inc
Magic Circle-Dixie Chopper
Massey-Ferguson Inc
Olathe Mfg Inc
Simplicity Mfg Inc
Snapper Power Equipment
Steiner Turf Equipment Inc
Toro Co
Waldon Inc
Walker Mfg Co
Wheel Horse Products Inc

Equipment for the turf care professional.

Olathe

Setting the standards for sweepers.



Feel like your grass clippings may be getting ahead of you? Try this model 54HL 5' self-propelled sweeper unit with high lift for large area cleanup. 24hp engine, hydraulic-drive, with optional thatcher, sweeps wet or dry materials using 'sure-grip' rubber fingers.

Olathe personnel have been helping solve leaf/debris problems for over 30 years. Ranging in size from our model 42 (36" wide, 5hp tow-behind) to the large area tow units which are the 166e, the 166hl and the 65 PTO (all with 5' width, 5 cu. yd. capacities). Ground and high lift models.



Model 166E PTO powered tow-type



Model 65 PTO-powered 5' width



Model 166e 5' hydraulic ground dump



Model 166hl 5' width, 8 1/2' lift



Model 42 tow — type, 1/2 cu. yd. 5 hp, 3' swath, finger or brush reels.



Model 41MVS - 66" wide tow-type, self-contained with 7 cu. yd. capacity

Write or call your local Olathe/Toro dealer for free demo or call 1-800-255-6438.

OLATHE MANUFACTURING, INC.
100 INDUSTRIAL PARKWAY, INDUSTRIAL AIRPORT, KANSAS 66031

800-255-6438
913-782-4396



Snow Plows

Bolens Corp
Bomford & Evershed Ltd
J I Case Outdoor Power Equipment Div
Deere & Co
Deutz-Allis Corp
Excel Industries Inc
Gravely Intl Inc
Guest Industries Inc
Ingersoll Equipment Co
Lawn-Boy Inc
Waldon Inc
Wheel Horse Products Inc

Sod Cutters

Ames Co
Brouwer Turf Equipment Ltd
Earl J Crane Inc & Assocs
Cushman
Teledyne Princeton
Turco Mfg Inc

Sod Equipment

Brouwer Turf Equipment Ltd
Fuerst Brothers Inc
Goossen Industries
Teledyne Princeton

Sod Harvesters

Brouwer Turf Equipment Ltd
Teledyne Princeton

Soil Moisture Sensing Equipment

Forestry Suppliers Inc
Green Pro Services
Rain Bird Sprinkler Mfg

Soil Samplers

Forestry Suppliers Inc
Green Pro Services
JISCO
Johnson's Industrial Supply Co
LESCO Inc
Na-Churs Plant Food Co
Nature's Touch
Outdoor Products & Supply Inc
Professional Turf Mfg
Spectrum Technologies Inc
Westheffer Co

Soil Shredders

Lindig Mfg Corp
Royer Foundry & Machine Co

Soil Test Meters

Forestry Suppliers Inc
Green Pro Services
Nature's Touch
Outdoor Products & Supply Inc

Circle No. 149 on Reader Inquiry Card

The art of application for maximum germination.

		POUNDS OF SEED PER 1000 SQ. FT. AT 2.5 M.P.H.	
		SEED	
TYPE	BRAND		
BENTGRASS	PENNEAGLE	1.5	2.0
	PENNCROSS	2.0	3.0
KENTUCKY BLUEGRASS	ASPEN	1.3	2.0
	RUGBY	.2	.2
	PARADE	.3	.3
FESCUE	SCALDIS HAWK	.2	.2
	RUBY CREEPER	.2	.2
RYEGRASS PERENNIAL	GALWAY TALL	.2	.2
	PERENNIAL	.2	.2
MIXTURE	OVERSEED	.2	.2

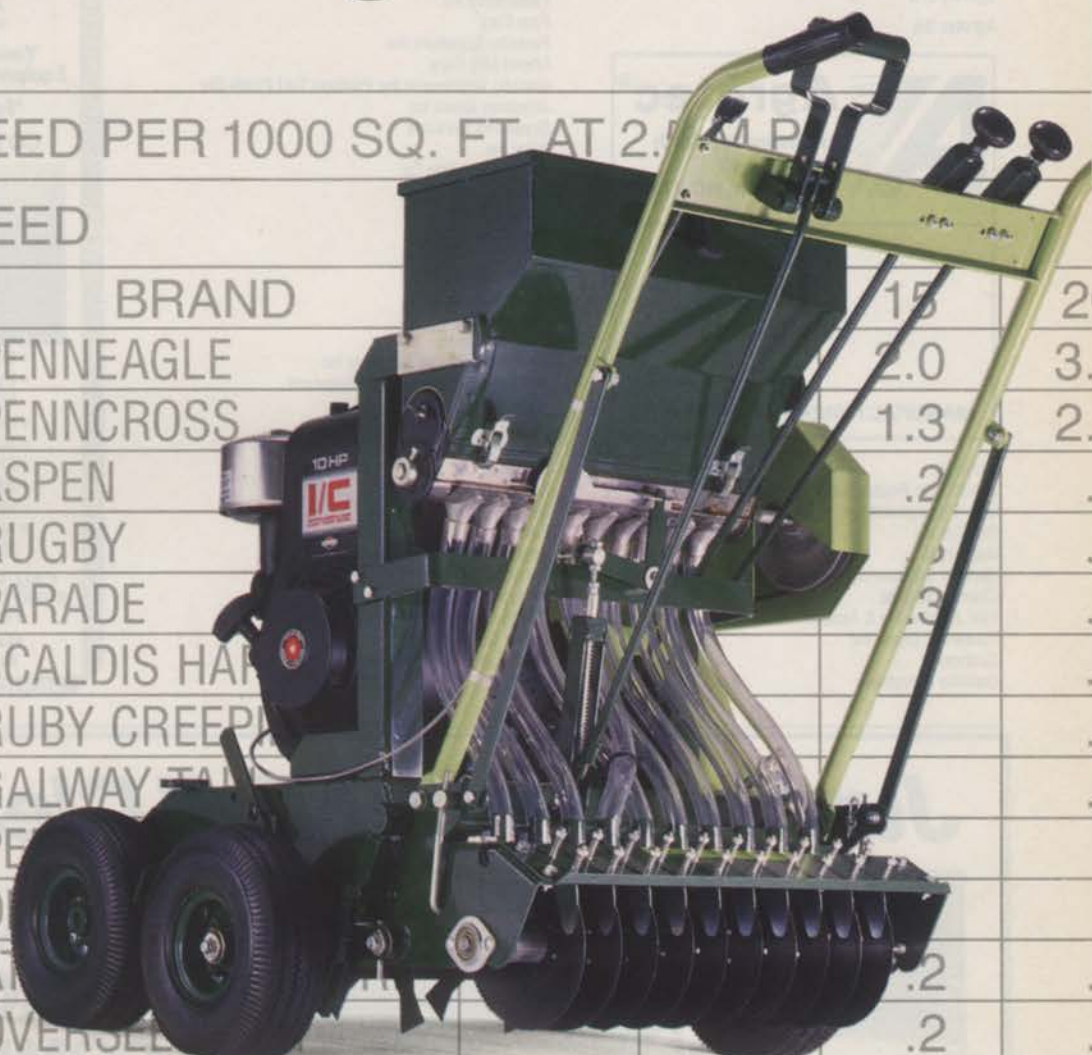

The Ryan® Mataway® Overseeder is simply better.

Better results begin with the basics, like seed calibration. An easy-to-read chart on the Mataway Overseeder tells you the exact setting for pounds of seed needed per 1,000 sq. ft. Just look it up, load it up, select setting, and you're ready to go.

Two-inch spacing between rows gives you a dense pattern for one-pass application. Gandy® precision metering and an easily removed disc-type seed delivery system places the seed directly into the slits for uniform seed/soil contact allowing maximum germination.

The result is a lusher, thicker lawn.

The Ryan Mataway Overseeder gives you the flexibility to power rake, overseed, or to do both at the same time. Call today or contact your nearest Ryan dealer for more information and a free test drive demonstration.

Call toll free 1-800-228-4444 for all the details.

RYAN®

BUILT TO LAST

6536 Ryan, P.O. Box 82409, Lincoln, NE 68501

© Outboard Marine Corporation, 1987. All rights reserved.

Equipment

continued

Spectrum Technologies Inc
Westheffer Co

Sprayers

Agrotec Inc



Agrotec®
Highway 35, North
P.O. Box 49
Pendleton, NC 27862

Telephone:
919-585-1222
Fax:
919-585-1023

MANUFACTURERS OF SPRAYERS

Ames Co
Arborchem Products Co
B & G Equipment Co
Broyhill Co
Bush Hog
Carlson Engineering & Mfg Inc
Country Mfg Inc
Earl J Crane Inc & Assocs
Howard S Crane Inc
Cushman
Danville Industries

Deere & Co
Deutz-Allis Corp
DOB Distributors Inc
Encap Products Co
Falkenberg Inc
Finn Corp
Forestry Suppliers Inc
Friend Mfg Corp
Garfield Williamson Inc Proform Turf Prods Div
Jonathan Green Inc
Green Pro Services
Hahn Inc
H D Hudson Mfg Co
Jacobsen Div
Kuker Industries
LESCO Inc
Maruyama US Inc
Master Mfg Co
Mid Dakota Corp
Monsanto
Nature's Touch
Outdoor Products & Supply Inc
Professional Tree & Turf Equipment
Professional Turf Mfg
Reinco Inc
Robco USA Inc
Roto-Hoe Co
Royalgard Products Co
D B Smith & Co
Solo Inc
Southern Mill Creek Products Co
Spraying Devices Inc
Spraying Systems Co
Strong Enterprises Inc
Treborg Corp
Vicon Farm Machinery Inc
Warren's Turf Nursery Inc

Westheffer Co

HANNAY RAVEN TANKS

WESTHEFFER COMPANY, INC.

**Your Complete Lawn Care
Equipment supplier For 30 years**

***Fall Special* \$ 2,175.00**
CQ 200 Skid Unit

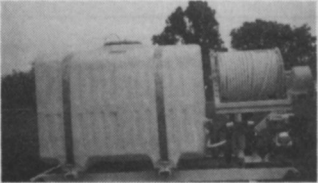

- 5hp Honda
- Hypro D:30 Diaphragm Pump
550 psi 9.5 gpm
- Hannay 1526 Electric Reel
- 300 Ft of 1/2" 600 psi Hose
- Chem-Lawn Gun
- 200 gallon Raven Pco Poly Tank
with Stainless Steel straps.
- Also available in other sizes
50-300 gallon.

**CALL TOLL FREE AND CHECK OUR
EVERYDAY LOWEST PRICES ON ALL
YOUR LAWN CARE NEEDS**

**National 1-800-362-3110
Kansas 1-800-332-0003**

HONDA GREEN GARDE

Just in time for Fall Clean-Up!



NEW PATENTED **PROMARK COMMERCIAL MODEL 750 VAC-N-MULCH**

- Patented mulching chamber reduces volume of leaves and ground litter by an easy-to-handle ratio of 10 to 1.
- Reduces your trips to the landfill location and your dumping expenses by as much as 80% to 100%.
- Material may be composted or used as mulch.

FAX US AT
(818) 961-2307



PROMARK PRODUCTS INC.

330 9th Ave. City of Industry, Ca. 91746. (818) 961-9783

**CONTACT US TODAY
FOR COMPLETE DETAILS**

Circle No. 156 on Reader Inquiry Card

Attn: Landscape Contractors

T-90



HydroSeeders

T-120



T-50

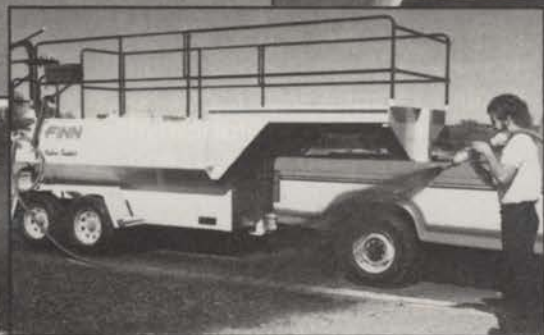

T-170/T-280/T-330

How many opportunities will you miss because you don't have a HydroSeeder or Mulch Spreader? Is your equipment out of date and due for replacement? Can you afford to wait another year? New Finn HydroSeeders and Mulch Spreaders with the LATEST state-of-the-art design offer the greatest return on your investment. Finn has a full line of labor saving HydroSeeders and Mulch Spreaders to choose from. Let us help you decide on the model that meets your needs.

B-250

Mulch Spreaders



B-70



Krimper



C-15

Yes, I want to know more about how I can take that next step to greater job efficiency and cost effectiveness.

- Send information about Finn HydroSeeders.
- Send information about Finn Mulch Spreaders.
- Have a Finn representative call me.
- Send information about financing programs.

Name _____

Company: _____

Address: _____

Phone: _____

Do you currently own a HydroSeeder? _____

Mulch Spreader? _____

FINN

CORPORATION

9281 LeSaint Dr. • Fairfield, Ohio • 45014

Toll-free: (800) 543-7166 • Ohio Residents Call Collect: (513) 874-2818

PRODUCTS FOR A BETTER ENVIRONMENT

Circle No. 127 on Reader Inquiry Card

Equipment

continued

Wheel Horse Products Inc
Wheel Spray Corp

WHEEL SPRAY CORP.
BOX 97 • DELAFIELD, WI 53018
PH: (414) 646-8640

*Exclusive manufacturer of the
Grounds Wheelie*

Sprayers, Measuring Equipment

Agrotec Inc
Arborchem Products Co
Broyhill Co
Encap Products Co
Falkenberg Inc
Forestry Suppliers Inc
Green Pro Services
Micro-Trak Systems Inc
Nature's Touch
Professional Tree & Turf Equipment
Raven Industries Inc
Spraying Devices Inc
Strong Enterprises Inc
Trebtor Corp
Westheffer Co
Wheel Spray Corp

Spray Guns

Agrotec Inc
Arborchem Products Co
Broyhill Co
Encap Products Co
Falkenberg Inc
Friend Mfg Corp

Green Pro Services
Hypro Corp
LESCO Inc
Maruyama US Inc
Master Mfg Co
Moyer & Son Inc
Nature's Touch
Professional Tree & Turf Equipment
Professional Turf Mfg
Robco USA Inc
D B Smith & Co
Southern Mill Creek Products Co
Spraying Devices Inc
Strong Enterprises Inc
Trebtor Corp
Tuflex Mfg Co
Westheffer Co

Spray Units

Agrotec Inc
Arborchem Products Co
Broyhill Co
Encap Products Co
Falkenberg Inc
Friend Mfg Corp
Green Pro Services
Hahn Inc
LESCO Inc
Maruyama US Inc
Na-Churs Plant Food Co
Nature's Touch
Professional Tree & Turf Equipment
Professional Turf Mfg
Robco USA Inc
Southern Mill Creek Products Co
Spraying Devices Inc
Strong Enterprises Inc

Trebtor Corp
Tuflex Mfg Co
Westheffer Co

Spray Units, Mixer Proportioners

Arborchem Products Co
Hypro Corp
Nature's Touch
Professional Tree & Turf Equipment
Raven Industries Inc
Strong Enterprises Inc
Westheffer Co

Spreaders

Ames Co
BEFCO Inc
Brinly-Hardy Co
Country Mfg Inc
Cushman
Deere & Co
Deutz-Allis Corp
DOB Distributors Inc
Gandy Co



Turf Tender® Lawn Spreaders
Sweep Master™ Turf Brush
Convertible Lawn Rollers
Gandy Measuring Wheels

Gandy Company 1-800-544-2639
P.O. Box 528, Owatonna, MN 55060

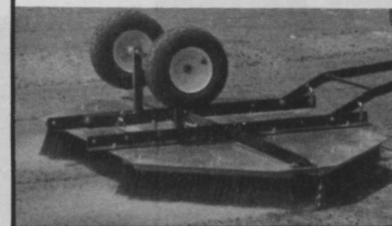

Garfield Williamson Inc Proform Turf Prods Div
Hahn Inc
LESCO Inc
Mid Dakota Corp
Precision Products Inc
Professional Tree & Turf Equipment
Professional Turf Mfg
PSB Co
Salsco Inc
O M Scott & Sons Co
Seymour Mfg Co
Southern Mill Creek Products Co
Vicon Farm Machinery Inc
Warren's Turf Nursery Inc
Westheffer Co
Wheel Horse Products Inc

Straw Blowers

Bowie Industries Inc
Howard S Crane Inc



One-Pass Power Rake 'n' Vac

This one-pass grounds maintenance machine removes thatch, aeration plugs, and debris in a 5-foot swath — and mulches the materials, so they pack better and decompose faster.

Mid-flex design and 10" rollers on the floating deck give the PTO-driven flail Rake excellent tracking. An accessory hand-held vacuum hose is also available for the Vac, which is powered by its own 11 H.P. gasoline engine.

The large 128 cu. ft. capacity trailer, with automatic endgate, tilts for easy unloading.

Ask about the convenient terms available with Goossen's all-new **TurfTeam Leasing.**

Goossen
INDUSTRIES

Call Toll-Free 1-800-228-6542 • (In Nebraska: 402-228-4226)
P.O. Box 705 • Beatrice, Nebraska 68310

Circle No. 129
on Reader
Inquiry Card

MOST COMMERCIAL MOWERS DON'T HAVE THE GUTS TO MAKE THIS COMPARISON.

Look carefully at a Scag mower. Then compare it to the competition. Scag commercial mowers outperform and outlast the competition time and time again. Why? Because Scag commercial mowers are simply the best, from the inside out.

Scag also manufactures a complete line of commercial riders from 40- to 72-inch cutting decks and 13 to 20HP engines, plus a new 61-inch hydrostatic rider. See the complete line of Scag commercial mowers today.

- New 72-inch deck with Kohler electric start engine makes short work of long jobs. Walker decks available from 32- to 72-inch cutting widths, 8 to 20HP engines.

- Five-speed gear box gives Scag walkers a faster ground speed than many competitive belt driven machines.

- Five gallon fuel tank extends time between refueling.

- Comfortable operator presence controls for increased safety.

- Scag's Twin Power Belt doubles friction to pulley surface.

- "No-tread" flotation caster wheels and carefully balanced deck combine to give a manicure-finish cut every time.

- Oversized pulleys and heavy-duty spindle housings are engineered for durability and serviceability.



SIMPLY THE BEST

SCAG

POWER EQUIPMENT

SUBSIDIARY OF METALCRAFT OF MAYVILLE
1000 Metalcraft Drive
Mayville, WI 53050
1-414-387-D100

Circle No. 159 on Reader Inquiry Card

Equipment

continued

Finn Corp
Goossen Industries
Hydro Turf & Assoc
Reinco Inc

Stump Cutters

Badger Chipper Co
Chipmore Mfg Co
Heckendorn Mfg Co
Promark Products Inc
Rayco Mfg Co

RAYCO®

"The Stump Cutter People"

6822 Lincoln Way East, Wooster, OH 44691

1-800-392-2687 (Ohio)

1-800-392-2686 (Out of State)

FAX (216) 264-3697

Steiner Turf Equipment Inc
Vermeer Mfg Co

Sweepers

Billy Goat Industries
Bomford & Evershed Ltd
J I Case Outdoor Power Equipment Div
Country Mfg Inc
Deere & Co
Ford New Holland Inc
Gandy Co
Gravelly Intl Inc
Grazer Div M & W Gear Co
Grazer Div Willsey-D

Jacobsen Div
Lindig Mfg Corp
Mathews Co
Olathe Mfg Inc
Steiner Turf Equipment Inc
Tennant Co
Waldon Inc
Wheel Horse Products Inc

Tanks, Fiberglass

Agrotec Inc
Arborchem Products Co
Broyhill Co
Friend Mfg Corp
Green Pro Services
LESCO Inc
Professional Tree & Turf Equipment
Professional Turf Mfg
Raven Industries Inc
Southern Mill Creek Products Co
Spraying Devices Inc
Strong Enterprises Inc
Tufflex Mfg Co
Westheffer Co

Tanks, Metal

Arborchem Products Co
B & G Equipment Co
Friend Mfg Corp
Professional Tree & Turf Equipment
Professional Turf Mfg
Robco USA Inc
Southern Mill Creek Products Co
Strong Enterprises Inc
Westheffer Co

Tanks, Polyethylene

Agrotec Inc
Arborchem Products Co
B & G Equipment Co
Broyhill Co
Green Pro Services
LESCO Inc
Na-Churs Plant Food Co
Professional Tree & Turf Equipment
Professional Turf Mfg
Raven Industries Inc
Southern Mill Creek Products Co
Strong Enterprises Inc
Westheffer Co

Tillers

Ariens Co
BEFCO Inc
Earl J Crane Inc & Assocs
Deere & Co
Feldmann Engineering & Mfg Co
Ford New Holland Inc
Green Machine
Hoffco Inc
Homelite Div
Honda Power Equipment
Ingersoll Equipment Co
Kubota Tractor Corp
Kuhn Farm Machinery Inc
Lawn-Boy Inc
Roto-Hoe Co
Snapper Power Equipment
Solo Inc
Toro Co
Wheel Horse Products Inc

Tillers, Tractor-Mounted

Bolens Corp
Bush Hog
Earl J Crane Inc & Assocs
Deere & Co
Deutz-Allis Corp
Ford New Holland Inc
Gravelly Intl Inc
Howard Rotavator Co
Ingersoll Equipment Co
Kubota Tractor Corp
Massey-Ferguson Inc
Simplicity Mfg Inc
Snapper Power Equipment
Steiner Turf Equipment Inc
Wheel Horse Products Inc
Woods Div

Tool Boxes

Forestry Suppliers Inc
Professional Tree & Turf Equipment
Professional Turf Mfg
Reading Body Works Inc
Westheffer Co
Woodstream Corp

Topdressers

Earl J Crane Inc & Assocs
Green Care Intl
Hahn Inc
Terracare Products Co
Turfco Mfg Inc
Vicon Farm Machinery Inc

Topdressing Brushes

Country Mfg Inc
Gandy Co

Tractors & Attachments

Ariens Co
Bolens Corp

"With a Wells Cargo Behind... You Never Look Back"



28 FT. WELLS CARGO EXPRESS WAGON

ALL YOUR GEAR...

SECURE, ORGANIZED AND READY TO ROLL

We can say, "We build the best". Our specifications sheets will back that up. But why else should you consider Wells Cargo? How about:

- Factory Service Facilities - GA, IN, TX, UT.
- US Wide Dealer & Service Network.
- A Product Designed & Built for 15 Yrs. Hard Service, and More.
- Second-to-None 3 Yr. Warranty Coverage.
- Full Line Ball-Hitch Units 6" - 32" and Up.
- Full Line Fifth Wheel Units 20' - 40' and Up.

CATALOGS
SPECIFICATIONS

CALL

1-800-348-7553
SAY YOU SAW IT IN
LANDSCAPE MGT.



WELLS CARGO

SINCE
1954

WELLS CARGO, INC. P.O. BOX 728-837 ELKHART, IN 46515

Circle No. 170 on Reader Inquiry Card

MEET THE PRO



EXPEDITETM

by Monsanto

EXPEDITE™: THE PROFESSIONAL SYSTEM

PROfessional system of solutions

Expedite provides a complete pesticide delivery system, consisting of specially formulated, premixed pesticides and an application lance. Designed to solve a variety of application problems with ease and convenience, Expedite offers professional results through an advanced spray application technology. Additional chemistry is being developed to expand the Expedite product portfolio.



PROgrammable control and accuracy

Easy-access controls on the Expedite lance let you adjust swath width, droplet size and flow rate for precise, accurate spraying. Two application discs let you match spray patterns to varying situations. Plus, the built-in pacer control allows for consistent walking speed and accurate calibration. It all adds up to efficient, low-volume spraying you can program for superior performance.



PROmotest effective weed control

Both the Expedite grass and weed herbicide and broad-leaf herbicide are specially formulated to provide effective control of labeled weeds. And the visible spray pattern lets you see exactly where you're spraying for improved accuracy. As a result, you can count on Expedite for general trimming and edging, spot treatments and broadcast applications.



DESIGN TO SIMPLIFY PESTICIDE APPLICATION

PROfitability improves

Cost-effective Expedite lowers your expenses by making spraying a fast, efficient, one-man operation. Downtime is substantially reduced and so are additional equipment and application costs. The premixed chemicals are designed to eliminate mixing errors and waste for even more savings.



PROtecs your workers

Expedite provides a closed system, and is designed to reduce worker exposure to pesticides. Ready-to-apply formulations come in specially designed 5-liter cartons that fit right into the backpack, so there's no exposure from mixing. Cleanup is simple and easy. And the lightweight Expedite lance and backpack minimize worker fatigue.

PROductivity increases

Expedite puts an end to time-consuming stop-and-start spraying. There's no mixing, measuring, water hauling or pumping. In fact, one 5-liter pack of Expedite pesticide covers up to one acre—the same as refilling a 3-gallon backpack sprayer 28 times! Just hook up, prime and spray—faster and farther than ever before.



THE PROFESSIONAL SYSTEM FOR PROFESSIONAL RESULTS*.



The PROfessional system

Expedite provides a pesticide application system with everything you need for professional spraying.

- Rechargeable Battery-Powered Lance
- 2 Application Discs
 - Serrated — for broadcast spraying and banding (12"-36" swath)
 - Square — for trimming, edging and spot treatments (6"-24" swath)
- Disc Ejector Tool
- Calibration Cup
- Backpack
- Battery Recharger Pack
- Pesticide and Cleaner Formulations

*We PROMISE

Our **90-DAY GUARANTEE*** assures a full refund if you're not satisfied with Expedite equipment or pesticides. In addition, our **ONE-YEAR WARRANTY*** covers all Expedite lance parts and repair costs for one year from the date of purchase.

Meet the PRO today!

Solve your pesticide application problems like a pro, with the new system of solutions: **EXPEDITE.**

For more information about Expedite
call toll-free

1-800-225-2883 *now.*

*For complete details refer to the warranty provided with the Expedite lance.

© MONSANTO COMPANY 1989

Expedite™ is a trademark of, and used under license from, Nomix Plc.

EXP-9-100

Equipment Companies

continued

Bomford & Evershed Ltd
J I Case Outdoor Power Equipment Div
Earl J Crane Inc & Assocs
Deere & Co
Deutz-Allis Corp
Engineering Products Co
Ford New Holland Inc
Forestry Suppliers Inc
Gravelly Intl Inc
Guest Industries Inc
Honda Power Equipment
Ingersoll Equipment Co
Jacobsen Div
Kioti Tractor Inc
Kubota Tractor Corp
Lawrence Inc
Massey-Ferguson Inc
Morbark Industries Inc
Simplicity Mfg Inc
Snapper Power Equipment
Steiner Turf Equipment Inc
Sumitomo Corp of America
Wheel Horse Products Inc

Trailers

Aer-Way
Ames Co
Burkeon Mfg Co
CHI Industries Inc
Country Mfg Inc
Earl J Crane Inc & Assocs
Howard S Crane Inc
Excel Industries Inc
Falkenberg Inc
Forestry Suppliers Inc
Giant-Vac Mfg Inc
Jacobsen Div
Jerr-Dan Co
Kuker Industries
Magline Inc
Olathe Mfg Inc
Precision Products Inc
Ravens Metal Products Inc
C L Reilly Tree Service & Mfg
Teledyne Princeton
Wells Cargo Inc
Westheffer Co
Yazoo Mfg Co

Traps, Animal

Forestry Suppliers Inc
Southern Mill Creek Products Co
Warren's Turf Nursery Inc
Woodstream Corp

Tree Braces

Foresight Products Inc
Forestry Suppliers Inc

Tree Cutters

Forestry Suppliers Inc
Seymour Smith & Son Inc

Tree Injectors

Arborchem Products Co
Broyhill Co
Creative Sales Inc
Doggett Corp
Forestry Suppliers Inc
LESCO Inc
J J Mauget Co
Moyer & Son Inc
Nature's Touch
Strong Enterprises Inc

Tree Movers, Spades

Big John Tree Transplanter Mfg Inc
Burkeon Mfg Co

Earl J Crane Inc & Assocs
Ford New Holland Inc
Mid Dakota Corp
Vermeer Mfg Co

Trenchers

American Trencher Inc
Burkeon Mfg Co
Ditch Witch
Ford New Holland Inc
LESCO Inc
Melroe Co
Seaman-Parsons Corp
Vermeer Mfg Co

Trimmers

Ariens Co
Bunton Co
Earl J Crane Inc & Assocs
Deere & Co
Forestry Suppliers Inc
Green Machine
Hoffco Inc
Homelite Div
Jacobsen Div
LESCO Inc
Maibo Inc
Maruyama US Inc
Omark Industries
Shindaiwa Inc
Seymour Smith & Son Inc
Snapper Power Equipment
Solo Inc

Tanaka Ltd
Toro Co
Yazoo Mfg Co

Trucks/Truck Bodies

Arbortech/A Scott Fetzer Co
Hi-Ranger Inc
Jerr-Dan Co
Mazda
Nissan Motor Corp USA
Professional Tree & Turf Equipment
Professional Turf Mfg
Reading Body Works Inc
Strong Enterprises Inc
Supreme Corp
Toyota Motor Sales USA Inc
Westheffer Co

Vacuums

Atwater Strong Inc
Billy Goat Industries



**BILLY
GOAT**
INDUSTRIES, INC.

P.O. Box 308
Lee's Summit, MO 64063-0308
Phone: (816) 524-9666
Fax: (816) 524-6983

Brouwer Turf Equipment Ltd
Deere & Co
Giant-Vac Mfg Inc
Goossen Industries
Grasshopper Co



AQUAPORE

Choose the subsurface irrigation system that leaves your designs unspoiled by unsightly, vandal-ridden sprinkler heads and bubblers. Choose Aquapore! Eliminate callbacks and replacement plantings from improper watering and stressful wet/dry cycles. Choose Aquapore!

Aquapore's patented, rubber and polyethylene pipe is porous and flexible, featuring a unique weeping action that dispenses water and fertilizers uniformly to the root zone. It reduces water consumption as much as 50 percent—important to

drought-plagued areas; and because there's no runoff, liability risks are minimal.

Choose an irrigation system that's simple to install, even for your sophisticated layouts; one that saves you time and money. Choose Aquapore! Select a system that's ideally suited for any commercial or residential situation—your options are limitless! Choose Aquapore!

Now that you've chosen Aquapore, write or call us for detailed information about the Aquapore system and the name of our nearest distributor.

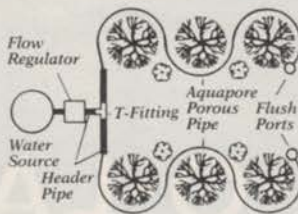

P.O. Box 6710 • Phoenix, AZ 85005-6710 • 602/936-8083 • 800/635-8379



Circle No. 104 on Reader Inquiry Card

continued

Grazer Div Willsey-D
Hoffco Inc
Ingersoll Equipment Co
Jacobsen Div
Maruyama US Inc
Promark Products Inc
Salsco Inc
Simplicity Mfg Inc
Woods Div
Yard Vac Products Inc

Vehicles, All-Terrain

Daihatsu America Inc
Deere & Co

Kawasaki Motors Corp USA
Mitsubishi
Polaris
Yamaha

Vehicles, Electric

CHI Industries Inc
Club Car Inc
Columbia ParCar Corp
Cushman
Deere & Co
E-Z-GO Textron
Melex USA Inc
Noland Car Co

Taylor-Dunn
Trojan Battery Co
Yamaha

Vehicles, Turf

CHI Industries Inc
Club Car Inc
Columbia ParCar Corp
Cushman
Daihatsu America Inc
Deere & Co
E-Z-GO Textron
Hahn Inc
Kawasaki Motors Corp USA
Mitsubishi
Noland Car Co
Olathe Mfg Inc
Taylor-Dunn
Terrain Vehicles Inc
Toro Co
Westheffer Co
Yamaha

Vibratory Plows

Burken Mfg Co
Ditch Witch
Melroe Co
Vermeer Mfg Co

Washers, Pressure

Agrotec Inc
Deere & Co
Falkenberg Inc
Ford New Holland Inc
Friend Mfg Corp
Green Pro Services
Homelite Div
Kubota Tractor Corp
Strong Enterprises Inc
Westheffer Co

Font'N-Aire®

From the City of Fountains

Font'N-Aire® is an aesthetically appealing, floating fountain that is biologically functional as well as visually appealing. Font'N-Aire® aids in the removal of unsightly algae in ponds and lakes without the use of chemicals or herbicides.

To improve water quality, Font'N-Aire® pulls oxygen deficient water from the depths and propels it as small droplets into the air. With an assortment of attractive spray patterns and horsepower ranges, Font'N-Aire® is capable of taking care of any of your fountain/aeration needs.

Font'N-Aire® features:

- Easy to install
- No complex underwater wiring conduits, pumps, pipes or valves
- Uses a more efficient, reduced horsepower pump
- Floating unit automatically adjusts to water level
- Additional units can be incorporated at a later date
- Lighted models available



AIR-O-LATOR®

8100 Paseo Boulevard • Kansas City, Missouri 64131 • (816) 363-4242
Toll Free: (800) 821-3177 • FAX: (816) 363-2322 LM 9/89



2. Equipment Companies

A C F Inc
9413 Burge Ave
Richmond VA 23237
804-743-9558

Advanced Drainage Systems Inc
3300 Riverside Dr
Columbus OH 43221
614-457-3051

Aer-Way
20 Phoebe St
Norwich ON Canada N0J 1P0
519-863-3414
Fax 519-863-2398

Circle No. 101 on Reader Inquiry Card

Trade In The Tools Of Your Trade!

Trade in *any* broken or used cutter, trimmer, blower, or sprayer for a Maruyama product and get factory cash back for your trade!

You can depend on the uncompromising quality of Maruyama commercial equipment. It's built for long life and backed with parts & service by local qualified dealers. We make long life products. When you're looking for the very best, look for Maruyama.

Call your local dealer today
Trade in offer ends soon.

Maruyama's total line includes

- BRUSHCUTTERS
- BLOWERS
- HEDGE TRIMMERS
- MIST DUSTERS
- POWER SPRAYERS
- GRANULE SPREADERS
- SOIL INJECTERS
- MANUAL SPRAYERS
- FRAME MOUNT SPRAYERS
- WATER PUMPS

U.S. Office
MARUYAMA U.S., Inc.
15436 N.E. 95th St.
Redmond, WA 98052
P.O. Box 2167, Redmond,
WA 98073/(206) 885-0811
FAX (206) 885-0123

International headquarters:
Maruyama Mfg. Co., Inc.
4-15 Uchi-Kanda 3-Chome
Chiyoda-Ku, Tokyo, 101 Japan
Branch offices: Paris, Singapore



Quality equipment since 1895

Circle No. 140 on Reader Inquiry Card



Equipment Companies

continued

Agrotec Inc
Hwy 35 N
PO Box 49
Pendleton NC 27862
919-585-1222
800-638-9363

Air-Lec Industries Inc
3300 Commercial Ave
Madison WI 53714
608-244-4754

Akzo Industrial Systems Co
One North Pack Sq
Asheville NC 28802
704-258-5050

Allied Products Inc
1816 Settlers Oval
Cleveland OH 44145
216-871-8909

American Playground Corp
1801 S Jackson St
Anderson IN 46016
317-642-0288

American Road Equipment Co
4201 N 26 St
Omaha NE 68111
402-451-2575

American Trencher Inc
503 Gay St
Delhi IA 52223
319-922-2981

Ames Co
PO Box 1774
Parkersburg WV 26102
304-424-3000

AMETEK/Plymouth Products Div
502 Indiana Ave
Sheboygan WI 53081
414-457-9435

Anchor Swan
PO Box 509
Worthington OH 43085
614-548-6511

Applied Biochemists Inc
5300 W County Line Rd
Mequon WI 53092
414-242-5870
800-558-5106

* Aquapore Moisture Systems
PO Box 6710
Phoenix AZ 85005-6710
602-936-8083

Arborchem Products Co
PO Box 1567
Fort Washington PA 19034
215-659-7922

Arbortech/A Scott Fetzer Co
3203 W Lincoln Way
Wooster OH 44691
216-264-4266
800-255-5715

Ariens Co
655 W Ryan St
Brillion WI 54110
414-756-2141

Atlantic Construction Fabrics Inc
9413 Burge Ave
Richmond VA 23237
804-743-9558

Atwater Strong Inc
1355 Evans Ave (44305)
PO Box 1108
Akron OH 44309
216-630-9822

Badger Chipper Co
6 Johnson Ct
Bay City MI 48706
517-894-4579

B & G Equipment Co
Rte 611
PO Box 130
Plumsteadville PA 18949
215-766-8811

BASF Corp Fibers Div
Geomatrix Systems
Enka NC 28728
704-667-7713

BEFCO Inc
1781 S Wesleyan Blvd
Rocky Mount NC 27803
919-977-9920

Berkeley Pumps
725 Ann St
Delavan WI 53115
414-728-4224

Big John Tree Transplanter Mfg Inc
Hwy 110 East
PO Box 608
Heber Springs AR 72543
501-362-8161

BigToys
2601 S Hood St
Tacoma WA 98409
206-572-7611

Billy Goat Industries
1803 S Jefferson
Lee's Summit MO 64063
816-524-9666

Bloch & Co
PO Box 18058
Cleveland OH 44118
216-371-0979

BlueBird International Inc
2778 S Tejon
Englewood CO 80110
303-781-4458

Bolens Corp
215 S Park St
Port Washington WI 53074
414-284-5521

Bomford & Evershed Ltd
Salford Priors
Nr Evesham
Worcs England WR11 5SW
(0789) 773383

* Bowie Industries Inc
1004 E Wise St
PO Box 931
Bowie TX 76230
817-872-1106
800-433-0934

Briggs & Stratton Corp
12301 W Wirth St
Wauwatosa WI 53222
414-259-5333

Brillion Iron Works Inc
200 Park Ave
Brillion WI 54110
414-756-2121

Brinly-Hardy Co
340 E Main St
Louisville KY 40202
502-585-3351

* Brouwer Turf Equipment Ltd
Woodbine Ave
Keswick ON Canada L4P 3E9
416-476-4311

Broyhill Co
N Market Sq
Dakota City NE 68731
402-987-3412

Buckner Irrigation
4381 N Brawley Ave
Fresno CA 93711
209-275-0500

* Bunton Co
PO Box 33247
Louisville KY 40232
502-966-0550
Fax 502-966-0564

Burkeen Mfg Co
11200 High Point Cove
Olive Branch MS 38654
601-895-4150

Bush Hog
Div Allied Products Corp
2501 Griffin Ave
Selma AL 36701
205-872-6261

Cambridge Soil Services of America Inc
106 Robert Gene
Glencoe AL 35905
205-492-7847

Carlson Engineering & Mfg Inc
68 Minwood Ave
Tallmadge OH 44278
216-633-5156

J I Case Outdoor Power Equipment Div
700 State St
Racine WI 53404
414-636-6011

A B Chance Co
210 North Allen
Centralia MO 65240
314-682-8450

CHI Industries Inc
PO Box 1148
Benton Harbor MI 49022
616-849-3400

Chipmore Mfg Co
6 Johnson Court
PO Box 671
Bay City MI 48707
517-894-4578

J A Cissel Mfg Co
PO Box 339
Farmingdale NJ 07727
201-938-6600
800-631-2234

Classen Mfg Inc
1403 Industrial Rd
Norfolk NE 68701
402-371-2294

Club Car Inc
PO Box 4658
Augusta GA 30917-4658
404-863-3000

We just eliminated your last excuse for buying a converted golf cart.

Introducing the Cushman® GT-1.
Suggested retail price: \$3,395.00*.

When you can have Cushman quality at a competitive price, there's no reason to accept second best.

The new Cushman GT-1 utility vehicle will outperform and outlast any converted golf cart on the market. Its frame and chassis are stronger and more durable. You'll find a bed

made of 14-gauge steel instead of 16-gauge steel. One-inch axles instead of 3/4-inch axles. And a proven Kohler industrial engine that's more reliable and easier to maintain.

When you need a utility vehicle that's been specifically designed for work instead of one that's been converted from play, contact your Cushman dealer for a GT-1 demonstration. Or call toll-free 1-800-228-4444 for more information today.



CUSHMAN
BUILT TO LAST

*Does not include sales tax, freight or dealer prep.
Prices may vary with dealer.

5454 Cushman, P.O. Box 82409, Lincoln, NE 68501

© Cushman Division of Outboard Marine Corporation, 1989. All rights reserved.

Circle No. 295 on Reader Inquiry Card

Equipment Companies

continued

- Columbia ParCar Corp
One Golf Car Rd
PO Box One
Deerfield WI 53531
608-764-5474
800-222-4653
- ★ Continental Bridge
Rte 5 Box 178
Alexandria MN 56308
612-852-7500
800-328-2047
800-572-7002(in MN)
- Conwed Fibers
1985 Tate Blvd SE Ste 350
Hickory NC 28601
704-327-6670
- Country Mfg Inc
333 Salem Ave Ext
PO Box 104
Fredericktown OH 43019
614-694-9926
- Earl J Crane Inc & Assocs
3975 County Rd 19
Tiffin OH 44883
419-447-8313
- Howard S Crane Inc
Box 88
Oneida NY 13421
315-363-3390
- Creative Sales Inc
222 N Park Ave
PO Box 501
Fremont NE 68025
402-727-4800
800-759-7739
- ★ Cub Cadet Commercial Mowers
PO Box 360930
Cleveland OH 44136
216-273-4550
- Curb King
3038 I 70 Business Loop E
Grand Junction CO 81504
303-434-5337
- ★ Cushman
900 N 21 St
Lincoln NE 68501
402-474-8494
800-228-4444
- Daihatsu America Inc
Dept C
4422 Corporate Center Dr
Los Alamitos CA 90720
714-761-7000
- Dandl Mfg Co
PO Box 687
Chico CA 95927
916-891-5163
- Danville Industries
Hwy 160
Danville KS 67036
316-962-5292
- Data Enterprises Inc
526 Rte 206
Trenton NJ 08610
609-298-8112
- Dedoes Industries Inc
91 Roberts Rd
Ossineke MI 49766
517-471-5413
- ★ Deere & Co
John Deere Rd
Moline IL 61265
309-765-8000
- ★ Delavan
PO Box 100
West Des Moines IA 50265-0100
515-274-1561
800-621-9357
- Deutz-Allis Corp
PO Box 933
Milwaukee WI 53201
414-475-3413
- DewEze Mfg Inc
Rte 2 Box 78
Harper KS 67058
316-896-7381
- Dewitt Co
Hwy 61 S
RR 3 Box 338
Sikeston MO 63801
800-325-0950
314-472-0048
- Ditch Witch
PO Box 66
Perry OK 73077-0066
405-336-4402
- Dixon Industries Inc
a Coleman Co
PO Box 1569
Coffeyville KS 67337
316-251-2000
- DOB Distributors Inc
12805 Eckmoor Rd
Silver Spring MD 20904
301-622-9397
- E I DuPont de Nemours & Co
1007 Market St
Wilmington DE 19898
302-992-6161
- Dyna/Energx Corp
245 E Sixth St
St Paul MN 55101-1988
612-293-0740
- Eberhart Steel Products/Plastic Div
417 E Jefferson
Mishawaka IN 46545-6594
219-259-2461
- Encap Products Co
PO Box 278
Mount Prospect IL 60056
312-593-6464
- Encon Safety Products
13333 Northwest Fwy
Houston TX 77040
713-462-4723
- Engineering Products Co
3000 S 160 St
New Berlin WI 53151
414-785-0786
- ★ Excel Industries Inc
200 S Ridge Rd
Hesston KS 67062
316-327-4911
- Exmark Mfg Co
Industrial Park
Beatrice NE 68310
402-223-4010
- ★ E-Z-GO Textron
PO Box 388
1451 Marvin Griffin Rd
Augusta GA 30913-2699
404-798-4311
- Fairmont Hydraulics Div Fairmont Railway Motors-
Harsco Corp
415 N Main St
Fairmont MN 56031
507-238-4357
- Falkenberg Inc
9420 SE Lawnfield
Portland OR 97015-9611
503-659-8655
800-424-7867
- Fanno Saw Works
PO Box 628
Chico CA 95927
916-895-1762
- Feldmann Engineering & Mfg Co
520 Forest Ave
Sheboygan Falls WI 53085-0908
414-467-6167
- ★ Finn Corp
9281 LeSaint Dr
Fairfield OH 45014
513-874-2818
- ★ Ford New Holland Inc
500 Diller Ave
New Holland PA 17557
717-355-1121
- Foresight Products Inc
6430 E 49 Dr
Commerce City CO 80022
303-286-8955
- Forestry Suppliers Inc
205 W Rankin St
PO Box 8397
Jackson MS 39284-8397
601-354-3565
- Franklin Electric
400 Spring St
Bluffton IN 46714
219-824-2900
- Friend Mfg Corp
Prospect St
Gasport NY 14067
716-772-2622
- Fuerst Brothers Inc
PO Box 427
Gibson City IL 60936
800-435-9630
- Gandy Co
528 Gandrud Rd
Owatonna MN 55060
507-451-5430
800-544-2639
- Gardenamerica
27940 Beale Ct
Valencia CA 91355
800-634-TURF
- Garfield Williamson Inc
Proform Turf Products Div
9 Stewart Place
Fairfield NJ 07006
201-882-7755

THE PROVEN PROFIT-MAKER.

Get ready to profit from fall lawn renovation with the LESCO Renovator 20. It's the easy-to-operate slicer/seeder

with built-in maneuverability and proven performance.

Powered by an 8-HP Honda engine, the LESCO Renovator 20 features exclusive hydraulic drive with 0 to 2 mph forward speed control. Spring-loaded reverse gives the unit greater maneuverability in tight areas and simplifies trailer loading and unloading. A compact low-profile

design provides excellent hillside stability.

Last year, the renovator supply did not meet demand. It could happen again. Prepare now to profit this fall. Order the proven profit-maker today.

We're ready to deliver. Contact your LESCO sales representative, visit the nearest LESCO Service Center or call toll free (800) 825-3726.

LESCO

LESCO, Inc.
20005 Lake Road
Rocky River, Ohio 44116
(216) 333-9250



Equipment Companies

continued

Giant-Vac Mfg Inc
PO Box 195
South Windham CT 06266
203-423-7741

Glenmac Inc
1805 Second Ave SW
PO Box 2135
Jamestown ND 58402
701-252-9300

Golf 2000 Corp
9842 Hibert St. Ste 257
San Diego CA 92131
800-824-9029 wait for tone 753

★ Goossen Industries
925 W Court St
Beatrice NE 68310
402-228-4226

★ Grasshopper Co
One Grasshopper Trail
PO Box 637
Moundridge KS 67107
316-345-8621

Gravely Intl Inc
One Gravely Lane
Clemmons NC 27012
919-766-4721

Grazer Div Willsey-D Inc
130 Main St
PO Box 460
Maple Hill KS 66507
913-663-2228

Grazer Div M & W Gear Co
Rt 47 S
Gibson City IL 60936
217-784-4261

★ Great Plains Mfg
PO Box 218
Affaria KS 67416
913-667-4755

Green Care Intl
17851 Georgetown Lane
Huntington Beach CA 92647
714-842-6003

Jonathan Green Inc
Squankum-Yellowbrook Rd
PO Box 326
Farmingdale NJ 07727
201-938-7007

Green Machine
20710 S Alameda St
Long Beach CA 90810
213-603-9888

Green Pro Services
380 S Franklin St
Hempstead NY 11550
516-538-6444

Guest Industries Inc
3601 Winsted Rd
Torrington CT 06790
203-482-1118

Hahn Inc
1625 N Garvin St
Evansville IN 47711-4596
812-428-2020

Hancor Inc
PO Box 1047
Findlay OH 45839
419-422-6521

Hannay Reels
600 E Main St
Westerlo NY 12193
518-797-3791

Heckendorn Mfg Co
302 Main
Cedar Point KS 66843
316-274-4201

Hendrix & Dail Inc
803 Industrial Blvd
PO Box 648
Greenville NC 27835-0648
919-758-4263

Herd Seeder Co
US 35 SE
Box 448
Logansport IN 46947
219-753-6311

Hi-Ranger Inc
N4 W22610 Bluemound Rd
Waukesha WI 53187
414-547-1000

Hoechst Celanese Corp
Interstate 85 @ Rd 57
PO Box 5887
Spartanburg SC 29304
800-845-7597

Hoffco Inc/Comet Industries
Div of Hoffco
358 NW "F" St
Richmond IN 47374-9971
317-966-8161
800-999-8161

Homelite Div Textron Inc
14401 Carowinds Blvd
Charlotte NC 28241
704-588-3200

Honda Power Equipment
100 W Alondra
Gardena CA 90247
213-327-8281

Howard Rotavator Co
102 Howard Ave
PO Box 7
Muscodia WI 53573
608-739-3106

H D Hudson Mfg Co
3439 Merriam Dr
Overland Park KS 66203
913-677-0094

Hunter Industries
1940 Diamond St
San Marcos CA 92069
619-744-9130

Hydro Turf and Assoc
160 W Industrial Dr
Gilberts IL 60136
312-551-1555

Hypro Corp
375 Fifth Ave NW
New Brighton MN 55112
612-633-9300

Imler Industries Inc
1117 Broadview
Columbus OH 43212
614-486-9068(OH)
800-433-1764

Ingersoll Equipment Co
PO Box 5001

Winneconne WI 54986
414-582-4455

Inject-O-Meter Mfg Co
820 Thornton St
Clovis NM 88101
505-763-4461

★ Jacobsen Div Textron Inc
1721 Packard Ave
Racine WI 53403
414-637-6711

Jerr-Dan Corp
1080 Hykes Rd
Greencastle PA 17225
717-597-7111

JISCO
1941 Karlin Dr
St Louis MO 63131
314-966-2420

Johnson's Industrial Supply Co
1941 Karlin Dr
St Louis MO 63131
314-966-2420

Kadco Inc
27 Jumel Place
Saratoga Springs NY 12866
518-587-2224

Kalo Inc
4370 W 109 St
Overland Park KS 66211-1311
913-491-9125

Kawasaki Motors Corp USA
PO Box 25252
Santa Ana CA 92799
714-770-0400 ext 2203

Kawasaki Motors Corp Engine Div
650 Industrial Circle S
PO Box 504
Shakopee MN 55379
612-445-6060

F D Kees Mfg Co
700-800 Park Ave
Beatrice NE 68310
402-223-2391

KEM Enterprises Inc
18425 Eighth Ave SW
Seattle WA 98166
206-433-0407

Kinco Mfg
170 N Pascal
St Paul MN 55104
612-644-4666

Kiotti Tractor Inc
6620 NE 79 Ct Ste 4
Portland OR 97218
503-252-3854

Kohler Co
Engine Div
444 Highland Dr
Kohler WI 53044
414-457-4441

Komatsu Dresser
4275 Shackelford Rd
Norcross GA 30093-2979
800-627-1700

★ Kubota Tractor Corp
550 W Artesia Blvd
Compton CA 90220
213-537-2531

Lightweight production mowing isn't just for golf courses.

The new Jacobsen HM-11 combines proven, quality lightweight mowing with a versatile 4-WD design to deliver a beautiful fairway-like cut in places that might surprise you.

Roughs, parks, universities, cemeteries . . . virtually anywhere you've always wanted a beautiful cut and high productivity, the versatile, high-capacity Jacobsen HM-11 delivers.

On-demand 4-wheel drive, a wide-track stance and powerful diesel take the HM-11 up challenging slopes that are too much for 2-wheel drive competitors.

Five heavy-duty 30" reels sweep through demanding schedules with an 11' cutting width. Just a touch of your toe lifts and lowers all reels simultaneously for more efficient cross-cutting. And you can get into those tight spots by mowing with 3-, 4- or 5-gangs.

Fixed or floating, our unique heavy-section reels hug the ground in all types of grass, for a smooth cut at higher mowing speeds and

better thatch control. Your choice of tough Jacobsen 6- or 10-blade reels, and high-speed or high-torque hydraulic reel motors match the HM-11 to your specific conditions. Plus, the fully programmable console—with cruise control—maximizes productivity.

Excellent maneuverability increases its versatility. Compact design and rear-wheel power steering make the HM-11 more agile and easy to operate. With a compact 70" transport width, even narrow paths and bridges won't stand in its way.

For quality mowing at $\frac{3}{4}$ " and above, nothing else comes close. And for tournament-quality fairways at less than $\frac{3}{4}$ ", Jacobsen leads the way again with the unique, up-front design of the LF-100.

To see either of these lightweight wonders in action, contact your Jacobsen distributor for a complete demonstration. Lease and finance plans available.

Jacobsen Division of Textron Inc., Racine, WI 53403.

**JACOBSEN
TEXTRON**

Jacobsen Division of Textron Inc.

Circle No. 133 on Reader Inquiry Card

©Jacobsen Division of Textron Inc. 1989

J-4-9



Equipment Companies

continued

Kuhn Farm Machinery Inc
PO Box 224
Vernon NY 13476
315-829-2620

Kuker Industries
13709 Industrial Rd
Omaha NE 68112
402-895-3050

Kut-Kwick Corp
1927 Newcastle St
Brunswick GA 31520
912-265-1630

Claude Laval Corp
1911 N Helm Ave
Fresno CA 93727
209-255-1601

★ Lawrence Inc
15170 Hickory St
Spring Lake MI 49456
616-847-4200

Lawn-Boy Inc
Hwy 57 S
Plymouth WI 53073
414-893-1011

★ LESCO Inc
20005 Lake Rd
Rocky River OH 44116
216-333-9250

Lindig Mfg Corp
1875 W County Rd C
St Paul MN 55113
612-633-3072

Little Beaver Inc
PO Box 840
Livingston TX 77351
409-327-3121

Locke Mfg Inc
1100 Boston Ave
Bridgeport CT 06610
203-333-3157

★ Lombardini USA Inc
601 Old Norcross Place Ste E
Lawrenceville GA 30245
404-963-4881
Fax 404-995-1107

Magee Machine & Mfg
4300 Forney Rd
Mesquite TX 75149
214-285-2554

Magic Circle Corp Dixie Chopper
RR 1 Box 345
Coatesville IN 46121
317-246-6845

Magline Inc
503 Mercer St
Pinconning MI 48605
517-879-2411

Maibo Inc
Rte One, E Stone Dr
Kingsport TN 37660
800-331-2306 800-543-8694(CA)

Mar-Mac Mfg Co
PO Box 278
McBee SC 29101
803-335-8211

★ Maruyama US Inc
15436 NE 95 St
Redmond WA 98052
206-885-0811

Massey-Ferguson Inc
1901 Bell Ave
Des Moines IA 50315
515-247-2098

Master Mfg Co
119 Main St
PO Box 3806
Sioux City IA 51102
712-258-0108

Mathews Co
500 Industrial Ave
Crystal Lake IL 60012
815-459-2210

J J Mauget Co
2810 N Figueroa St
Los Angeles CA 90065
213-227-1482

Mazda
7755 Irvine Center Dr
Irvine CA 92718
714-727-1990

Melcher Mfg Co
E 6017 Mission
Spokane WA 99212
509-535-7626

Melex USA Inc
1221 Front St
Raleigh NC 27609
919-828-7645

Melroe Co
PO Box 6019
 Fargo ND 58108-6019
701-241-8700

Micro-Trak Systems Inc
PO Box 3699
Mankato MN 56002
507-257-3600

Mid Dakota Corp
Box 728
Garrison ND 58540
701-337-5619

Middlesworth Engineering & Mfg Inc
1050E 200N
PO Box 165
Greentown IN 46936
317-628-2230

3M Occupational Health & Environmental Safety Div
Bldg 220-3E-04
3M Center
St Paul MN 55144-1000
800-666-6477

Mitsubishi
6400 W Katello
Cypress CA 90630
714-372-6424

Moisture Systems
Professional Irrigation Div
PO Box 574
Glastonbury CT 06033
203-633-3934

★ Monsanto
800 N Lindbergh
St Louis MO 63167
314-694-4310
800-225-2883

Morbark Industries Inc
PO Box 1000
Winn MI 48896
517-866-2381

Morie Co
1201 N High St
Millville NJ 08332
609-327-4500

Motorola Control Systems
3039 Kilgore Rd Ste 190
Rancho Cordova CA 95670
916-635-8884

MoTrim Inc
1070 Bylesville Rd
Cambridge OH 43725
614-439-2725

Moyer & Son Inc
PO Box 198
Souderton PA 18964
800-345-0419

Moyer Products Inc
3321 W Castor
Santa Ana CA 92704
714-549-2871

Na-Churs Plant Food Co
421 Leader St
Marion OH 43302
614-382-5701

Nalco Chemical Co
One Nalco Center
Naperville IL 60566-1024
312-961-9500

★ National Mower Co
700 Raymond Ave
St Paul MN 55114
612-646-4079

Nature's Touch
Div of Agro Chem Inc
11150 Addison St
Franklin Park IL 60131
312-455-6900

Nissan Motor Corp USA
18501 S Figueroa
Carson CA 90248-4504
213-719-5743

Noland Car Co
PO Box 190
Edgewater FL 32032-0190
904-427-9645

North American Green Inc
14649 Hwy 41 N
Evansville IN 47711
812-867-6632

★ Olathe Mfg Inc
100 Industrial Pkwy
Industrial Airport KS 66031
913-782-4396
800-255-6438
Fax 913-764-1473

Oly-Ola Sales Inc
148 W St Charles Rd
Villa Park IL 60181
312-833-3033
800-EDGINGS
Fax 312 833-0816

Omark Industries
4909 SE International Way
Portland OR 97222
503-653-8881

KUBOTA HAS THE MOWER IF YOU'RE SO INCLINED.



It doesn't have to be an uphill grind. Not with Kubota's F2400 Front Mower. Four-wheel drive delivers traction where you need it most—on uneven, slick or damp ground. No more wheel-spinning means no more turf damage.

If you're up against one tough obstacle course, there's rear-wheel steering and independent brakes. Together, they provide the tightest possible turning radius.

Then for your mowing comfort, there's our famous clutchless hydrostatic transmission, as well as power steering and tilt-wheel.

Attachments? You can choose from a 60" or 72" rotary mower, a flail mower, rotary broom, front blade or snowblower. Even a grass catcher with 60" and 72" dumping heights. Of course, they're all lifted hydraulically. Effortlessly.

And its powerful, economical

24hp diesel engine will leave you wondering why anyone would own anything less. So if you've got the inclination, just write for our free Grounds Maintenance Equipment Guide at Kubota Tractor Corporation, P.O. Box 7020-A, Compton, CA 90224-7020.



KUBOTA
Nothing like it on earth.

Equipment Companies

continued

★ Onan Corp
1400 73 Ave NE
Minneapolis MN 55432
612-574-5000

★ Otterbine/Barebo Inc
Rd 2 Main Rd E
PO Box 217
Emmaus PA 18049
215-965-6018
Fax 215-965-6050

Outdoor Products & Supply Inc
3924 Orchard Rd
Cleveland Heights OH 44121
216-587-5438

R L Parsons & Son ECI
AKA The Micro-Mower Co
7155 State Rt 142 SE
PO Box 28
West Jefferson OH 43162-0028
614-879-7601

Permaloc Aluminum Edging
13505 Barry St
Holland MI 49424
800-356-9660

Phillips Fibers Corp
PO Box 66
Greenville SC 29602
803-242-6600

Playworld Systems
PO Box 227
New Berlin PA 17855
800-233-8404

★ Polaris Industries Inc
1225 N Hwy 169
Plymouth MN 55441
612-542-0500

Power Lawnmower Parts Inc
1920 Lyell Ave
PO Box 60860
Rochester NY 14606
716-458-0800

Precision Products Inc
2415 S Grand Ave
Springfield IL 62708
217-528-1331

Presto Products Co
PO Box 2399
Appleton WI 54913
414-739-9471

Howard Price Turf Equipment
18155 Edison Ave
Chesterfield MO 63005
314-532-7000

Professional Tree & Turf Equipment
6945 Indiana Ct Ste 400
Golden CO 80403
303-422-7608
800-237-7785

Professional Turf Mfg
1801 Industrial Park Rd
Normal IL 61761
309-452-2155
800-367-9091

Progressive Electronics Inc
325 S El Dorado
Mesa AZ 85202
602-966-2931

Progressive Power Tools Corp
303 N Rose St, Ste 304

Kalamazoo MI 49007
800-635-5465
Fax 616-342-0517

★ Promark Products Inc
330 Ninth Ave
City of Industry CA 91746
818-961-9783

PSB Co
555 W Goodale St
Columbus OH 43216
614-228-5781

Rain Bird Sprinkler Mfg
145 N Grand Ave
Glendora CA 91740
818-963-9311

★ Ransomes Inc
One Bob Cat Lane
Johnson Creek WI 53038
414-699-2000

Raven Industries Inc
205 E Sixth
PO Box 1007
Sioux Falls SD 57117
605-336-2750

Ravens Metal Products
Trailite Div
PO Box 1168
Parkersburg WV 26102-1168
304-275-4247
Fax 304-275-4368

Rayco Mfg Inc
6822 Lincoln Way E
Wooster OH 44691
800-392-2686
800-392-2687 (OH)

Raymond Corp
S Canal St
Greene NY 13778
800-235-7200

Reach-All Inc
1300 Port Terminal Dr
Duluth MN 55816
218-722-9200

Reading Body Works Inc
Hancock Blvd & Gerry St
Reading PA 19611
215-775-3301

Reemay Inc
1000 Industrial Rd
PO Box 511
Old Hickory TN 37138
615-847-7000

C L Reilly Tree Service & Mfg
RR 1 Box 73
Crystal ND 58222
701-657-2369

★ Reinco Inc
520 North Ave
PO Box 512
Plainfield NJ 07060
800-526-7687

Richway Industries Ltd
525 Main St
Janesville IA 50647
319-987-2976

Robco USA Inc
PO Box 5556
Walnut Creek CA 94596
415-827-0926

Roseman Mfg Co
Box 158, Rte 29
Collegeville PA 19426
800-752-7673
215-489-1400 (PA)

Roto-Hoe Co
100 Auburn Rd
Newbury OH 44065
216-564-2294

Rousseau
8433 Mid County Ind
St Louis MO 63114
314-426-7377

Royalgard Products Co
100 Paces W, Ste 1240
2727 Paces Ferry Rd NW
Atlanta GA 30339
404-333-9067

Royer Foundry & Machine Co
158 Pringle St
Kingston PA 18702
717-287-9624

Salsco Inc
105 School House Rd
Cheshire CT 06410
203-271-1682

Sarlo Power Mowers Inc
2315 Anderson Ave
Fort Myers FL 33901
813-332-1955

★ Scag Power Equipment Inc
1000 Metalcraft Dr
Mayville WI 53050
414-387-0100

★ O M Scott & Sons Co
14111 Scottslawn Rd
Marysville OH 43041
513-644-0011 (OH call collect)
800-543-0006

Seaman-Parsons Corp
W161 N9116 Hayes Ave
Menomonee Falls WI 53051
414-251-3860

Sensation Div Gilson Brothers
Cty Trunk PP
PO Box 152
Plymouth WI 53073
414-893-1011

Seymour Mfg Co
500 N Broadway
Seymour IN 47274
812-522-2900

Shindaiwa Inc
11975 SW Herman Rd
Tualatin OR 97062
503-692-3070

Simplicity Mfg Inc
500 N Spring St
Port Washington WI 53074
414-377-5450

D B Smith & Co
Main St
Utica NY 13501
315-735-5223

Seymour Smith & Son Inc
900 Main St
Oakville CT 06779
203-274-2558



ANOTHER TURN FOR THE BETTER

Ransomes out-maneuvers the competition. Again. With the new T-3100 Bobcat (our idea of a great machine). Hydrostatic drive eliminates bothersome clutching and shifting. Just effortless forward and reverse control from a single foot pedal. And a three-wheel ride means precise turns for close trim work. If you think all this makes the T-3100 expensive, forget it. It's the most affordable commercial rider in its class.

The new T-3100 Bobcat from Ransomes.
Where else would you turn for great ideas?

For more great ideas, turn to your Ransomes distributor. Or, call Ransomes, Inc., One Bob Cat Lane, Johnson Creek, WI 53038, (414) 699-2000.

RANSOMES

BOB-CAT®

WHERE GREAT IDEAS START

Circle No. 273 on Reader Inquiry Card

Equipment Companies

continued

Smith Precision
1299 Lawrence Dr
Newbury Park CA 91320
805-498-6616

Snapper Power Equipment
535 Macon Rd
McDonough GA 30253
404-957-9141

Solo Inc
5100 Chestnut Ave
Newport News VA 23605
804-245-4228

Southern Mill Creek Products Co
5414 N 56 St
Tampa FL 33610
813-626-2111

Spectrum Technologies Inc
12010 S Aero Dr
Plainfield IL 60544
800-248-8873

Spraying Devices Inc
PO Box 3107
Visalia CA 93278
209-651-1306

Spraying Systems Co
North Ave
Wheaton IL 60188
312-665-5000

Standard Golf Co
220 E Fourth St
PO Box 68

Cedar Falls IA 50613
319-266-2638

Standard Oil Engineered Materials Co
6180 Cochran Rd
PO Box 391316
Solon OH 44139
216-349-6882

Stanley Hydraulic Tools
3810 SE Naef Rd
Milwaukie OR 97267
503-659-5660

Sta-Rite Industries Inc
293 S Wright St
Delavan WI 53115
414-728-5551

Steiner Turf Equipment Inc
930 Penn Ave
PO Box 85
Orrville OH 44667
216-683-0055

Strong Enterprises Inc
14090 SW 144 Ave Rd
Miami FL 33186
305-235-0967

Strong Mfg Co
N US Hwy 79
PO Box 8068
Pine Bluff AR 71611
501-535-4753

Submatic Inc
PO Box 246

Lubbock TX 79408
806-747-9000

Sumitomo Corp of America
Machinery Dept
345 Park Ave
New York NY 10154

Supreme Corp
16500 CR 38
PO Box 463
Goshen IN 46526
219-642-4888

Tanaka Ltd
22121 Crystal Creek Blvd SE
Bothell WA 98021
206-481-2000

Taylor-Dunn
2114 W Ball Rd
Anaheim CA 92804
714-956-4040

Tecumseh Products Co
900 North St
Grafton WI 53024
414-377-2700

Teledyne Princeton
955 W Walnut St
Canal Winchester OH 43110
614-837-9096

Teledyne Total Power
3409 Democrat Rd
Memphis TN 38118
901-365-3600

RIDE A WALKER

Discover Fast, Competitive, Profitable Mowing



Most commercial mowing operations are using walk-behind mowers because they have concluded no rider mower is compact or maneuverable enough to mow landscaped areas. Now maintenance operators all across the country are discovering the compact, maneuverable *Mid-Size Walker Mower* fits their job and saves labor (usually cuts labor 1/2). The labor saving *Walker* looks good whether your business is trying to produce profit or is operating on a budget. Write or call for a free brochure. Ask for a demonstration.

Walker Manufacturing Company, 1839 East Harmony Road, Ft. Collins, CO 80525 • 1-800-777-0356

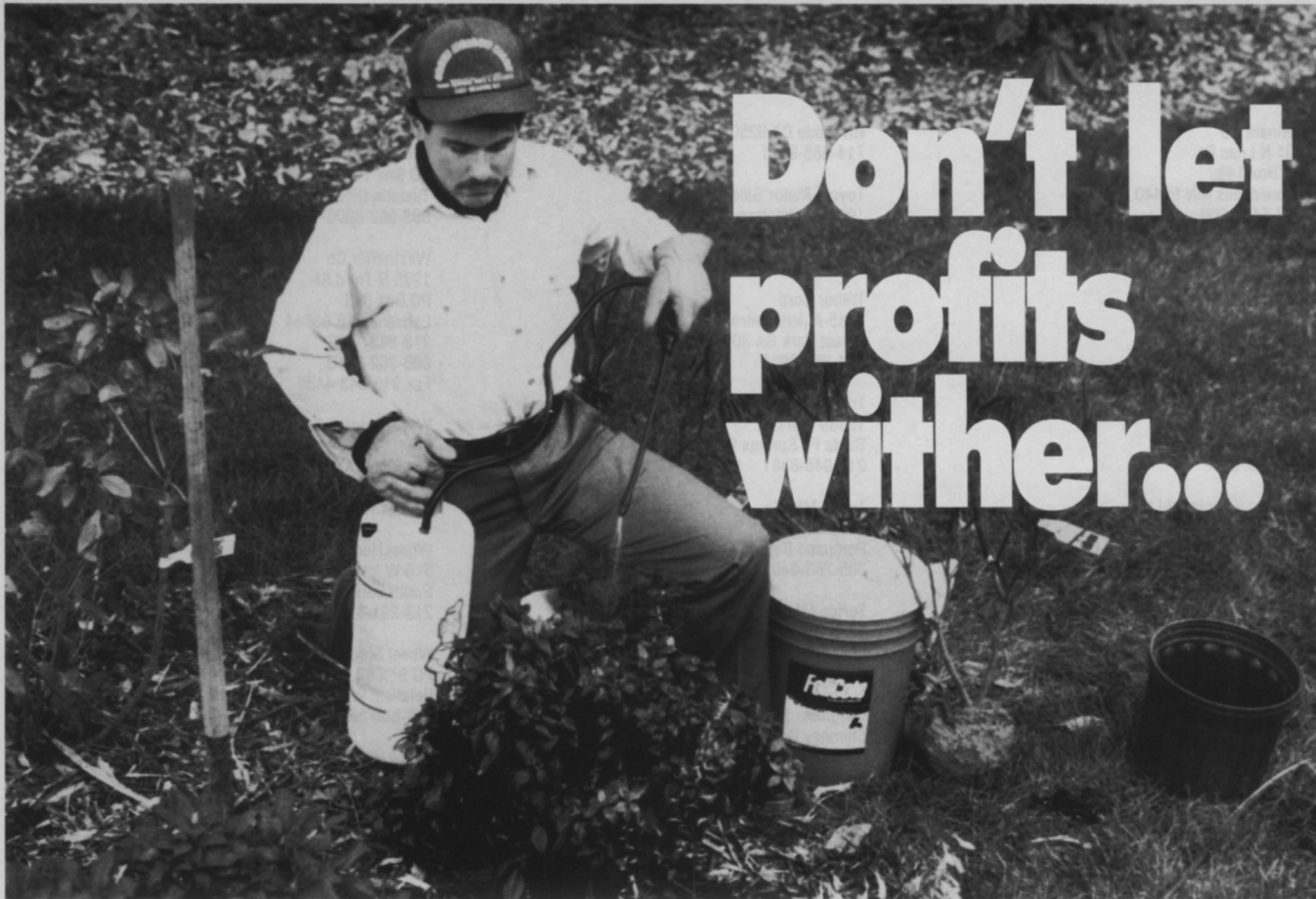

Don't let profits wither...

...Plant it right the first time.

Call-backs can be costly, and aggravating. Lock moisture in the plant and increase plant survival—use FOLICOTE® transpiration minimizer.

FOLICOTE reduces transplant shock and transportation stress by limiting foliar moisture loss. And FOLICOTE protects established plants from winter damage caused by sun or wind and summer drought conditions.

FOLICOTE is a wax emulsion transpiration minimizer that reduces moisture loss by partially blocking stomates, without interfering with plant growth. When used as directed, FOLICOTE has been proven effective and non-phytotoxic on a wide range of plants.

EASY & ECONOMICAL TO APPLY

FOLICOTE mixes easily with water and stays mixed. It forms a thin, natural-looking waxy layer on foliage. And it cleans out of spray equipment with warm, soapy water.

At a cost of about \$0.87 per finished gallon (including surfactant), FOLICOTE costs about half as much as its nearest competitor.

Consider offering your customers an economical FOLICOTE summer or winter protection application.

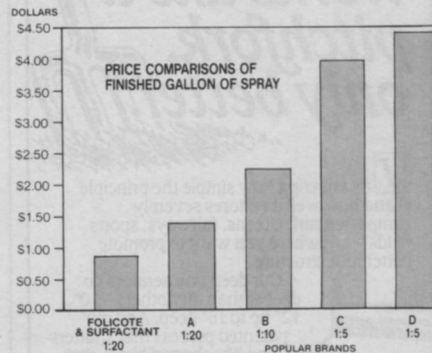

Apply FOLICOTE when shipping, transplanting and protecting... it adds up to greater profits for you and customer satisfaction. Can you afford to plant without it?

Ask your distributor about FOLICOTE, or call us.

1-800-257-7797, in N.J. (609) 665-1130

AQUATROLS

The Water Management People

1432 Union Avenue, Pennsauken, NJ 08110 FAX: (609) 665-0875

Equipment Companies

continued

Tennant Co
701 N Lilac Dr
PO Box 1452
Minneapolis MN 55440
612-540-1200

Terracare Products Co
PO Box 506
Pardeeville WI 53954
608-429-3402
Fax 608-429-2889

Terrain Vehicles Inc
221 Mitchell Court
PO Box 418
Addison IL 60101
312-953-8747

Thomas Equipment Ltd
55 Torlake Crescent
Toronto ON Canada M8Z 1B4
416-252-3714
Fax 416-259-0713

Thompson Seeder Co
US Hwy 35 S
PO Box 776
Logansport IN 46947
219-753-6366

★ Toro Co
8111 Lyndale Ave S
Bloomington MN 55420
612-887-8805

Toro Co Irrigation Div
5825 Jasmine St

Riverside CA 92504
714-688-9221

Toyota Motor Sales USA Inc
19001 S Western Ave
Torrance CA 90509
213-618-4000

Trebor Corp
4045-A Jonesboro Rd
Forest Park GA 30050
404-366-0957

Trojan Battery Co
12380 Clark St
Santa Fe Springs CA 90670
213-946-8381

Tuflex Mfg Co
1406 SW Eighth St
Pompano Beach FL 33069
305-785-6402

Turfco Mfg Co
3456 Washington Ave N
Minneapolis MN 55412
612-588-0741

Vaughans Seed Co
Chimney Rock Rd
PO Box 469
Bound Brook NJ 08805
201-356-4200

Vermeer Mfg Co
New Sharon Rd
PO Box 200
Pella IA 50219
515-628-3141

★ Verti-Drain
415 Washington Ave
Scranton PA 18503
717-961-6120

Vicon Farm Machinery Inc
3741 Cook Blvd
PO Box 6313
Chesapeake VA 23323
804-485-1600

Waldon Inc
201 W Oklahoma Ave
Fairview OK 73737
405-227-3711

★ Walker Mfg Co
1839 E Harmony Rd
Fort Collins CO 80525
303-226-1514

Warren's Turf Nursery Inc
Cordelia & Chadbourne Rds
PO Box 459
Suisun City CA 94585
707-422-5100

Weather-matic
3301 W Kingsley Rd
Garland TX 75041-2207
214-278-6131

★ Wells Cargo Inc
McNaughton St
PO Box 728-837
Elkhart IN 46515
219-264-9661
800-348-7553

Westendorf Mfg Co
Hwy 175
PO Box 29
Onawa IA 51040
712-423-2762

Western Wood Structures Inc
20675 SW 105 St
PO Box 130
Tualatin OR 97062
503-692-6900

Westheffer Co
1235 N Third St
PO Box 363
Lawrence KS 66044
913-843-1633
800-362-3110
Fax 913-843-4486

Weyerhaeuser Co
EF-4
Tacoma WA 98477
206-924-3138
800-443-9179

Wheel Horse Products Inc
515 W Ireland Rd
South Bend IN 46614
219-291-3112

Wheel Spray Corp
PO Box 97
Delafield WI 53018
414-646-8640

Winco/Energx Corp
245 E Sixth St
St Paul MN 55101-1988
612-293-0740
Telex: 29-0740 ENERGY STP
Fax: 612-292-0851

Woods Div Hesston Corp
Hwy 2 S
PO Box 1000
Oregon IL 61061
815-732-2141

Woodstream Corp
69 N Locust St
Lititz PA 17543
717-626-2125

Yamaha
6555 Katella Ave
Cypress CA 90630
714-761-7304
800-447-4700

Yard Vac Products Inc
3849 E Ventura
Fresno CA 93702
209-251-7125

Yazoo Mfg Co
3650 Bay St
Jackson MS 39216
601-366-6421

LANDSCAPE MANAGEMENT

...is also an important
piece of equipment for
landscape professionals.
Send in your subscription
card today!

VERTI-DRAIN®

*Works like a
pitchfork,
only better!*



It's amazing how simple the principle is and how well it restores severely compacted turf. Greens, fairways, sports fields—anywhere you want to promote better root structure.

Our deep tine aerators go deeper than any others—10", 12" up to 16" deep. And our patented process that shatters and lifts the turf like a pitchfork can't be duplicated. That's why world-wide VERTI-DRAIN is the recognized leader. See it for yourself.

Call or write for our free literature, videotape or a demonstration near you.



VERTI-DRAIN®
415 Washington Avenue, Scranton, PA 18503
717-961-6120

Circle No. 168 on Reader Inquiry Card



Over the top...

Over the problem.

For grounds maintenance, nurseries, Christmas tree farms, highway or municipal vegetation—for just about any grass control problem—Poast® herbicide is the simple solution.

Poast delivers consistent control of the toughest grasses. Like bermudagrass and crabgrass, quackgrass and foxtails. Yet, Poast is proven gentle to established plantings of valuable greenery. Like flowers, shrubs, trees and ground covers.

With Poast, you don't have to bother with directed or shielded sprays. You

can apply Poast over-the-top of all stages of ornamental growth. And you don't have to worry about soil residue or leaching. Because Poast is meant to treat your grasses, not your soil.

And perhaps best of all, Poast can be highly cost efficient. It can eliminate labor-intensive and time-consuming hand roguing or hoeing. And labor and time equal money.

To keep grass in its place, always follow label directions and count on Poast—the last word in safe, effective grass control.

BASF Corporation
Chemicals Division



BASF

Poast is a registered trademark of BASF AG.
© 1988 BASF Corporation.

Circle No. 106 on Reader Inquiry Card

SEPTEMBER 1989/LANDSCAPE MANAGEMENT 71



3. Chemicals

This section is broken down by chemical product with companies providing that chemical listed below. Products common name (in parentheses) and brand names are listed on the line following the company name.

Absorbefacient (Aquatic)

Aquashade Inc
(Acid Blue q, Acid Yellow 23) Aquashade

Aquashade is:

- **Economical**, because it's long lasting.
- **Non-toxic**, no harm to humans, livestock, fish, wildlife and turf. (EPA Registered)
- **Non-killing**, because it controls growth by suppressing.
- **Easy to use**, by just pouring
- **Beautifying**, by coloring water to a natural teal blue.

AQUASHADE
AQUATIC PLANT GROWTH CONTROL

Aquatrols Corp
(Copolymer Acrylamide Acrylate) SuperSorb Water Absorbant
Nalco Chemical Co
Nalco 2151, Nalquatic, Nalco-Trol, Nalco-Trol II, Sta-Put
Riverdale Chemical Co
Riverdale
Spectrum Technologies Inc
Lake Blue
UAP Special Products Inc

Adjuvant/Carrier

Arborchem Products Co
(Crop oil & surfactants) Clean Cut; (crop oil, surfactant & pine oil) Clean Cut + Pine; (crop oil, surfactant, citrus oil) Clean Cut + Citrus; (patent) Basal Oil
Chevron Chemical Co
(Alkylaryl/polyoxyethylene, glycols, free fatty acids, isopropanol) Ortho X-77
W A Cleary Chemical Corp
Super-Wet, Super Wet 15G
Cumberland Intl Corp
Ag-Chem Activator
Elanco Products Co
Improve

Fermenta ASC Corp
(Fatty amine ethoxylate) Frigate
Fermone Chemicals Inc
(Protein feeding stimulant) Entice
Green Pro Services
(non-ionic wetting agent) VITA Flow
Kalo Inc
Regulaid
Leffingwell
(Non-ionic surfactants) Activate, Super Savol; (NPK, secondary & micronutrients) Sorba-Spray; Sorbacide
LESCO Inc
LESCO Spreader Sticker, LESCO-WET
Moyer Products Inc
(Alicaryl/polyoxyethylene ether) Spray Film B
Nature's Touch
Save A Tree; (alanine, aspartic acid, glutamic acid, cystine & other proteins) Save A Tree Drought Adjuvant
Necessary Trading Co
(non-ionic surfactant) Spray Enhancer
PBI-Gordon Corp
(Petroleum oil-paraffin base, surfactant blend) Adjumec
Precision Laboratories Inc
Pen-A-Trate
Southern Mill Creek Products Co
SMCP Spreader Sticker
Spectrum Technologies Inc
(buffering/wetting agent) Adjust
UAP Special Products Inc
Activator 90
Uniroyal Chemical
Activate

Algaecide

Applied Biochemists Inc
(Chelated Copper) Cutrine-Plus, Cutrine-Plus Granular
Great Lakes Biochemical Co
(Chelated Copper Liquid) Algimy ciw PLL-C; (Chelated Copper Tablet) Slow Release Algimycin PLL-C; (wetable powder) Algimy ciw GLBXII
Hendrix and Dail Inc
(Formaldehyde) HD Bi-O-Cide
LESCO Inc
(Elemental copper) Lescocide-Plus
Nacco
NaccoSan B-60
Safer Inc
(Potassium salts of fatty acids) Safer Moss & Algae Killer
Southern Mill Creek Products Co
A+V70 Plus
UAP Special Products Inc

Antitranspirant

Aquatrols Corp
(Wax emulsion) FoliCote Transpiration Minimizer
W A Cleary Chemical Corp
(acrylic base) Clearspray
Green Pro Services
(natural/synthetic anti desiccant) Vita Coat
Nature's Touch
(concentrated cellular gums) Nature's Touch Leaf Cote & Leaf Cote Clear; (concentrated cellular gums with non fade dyes) Nature's Touch Leaf Coat Green
PBI-Gordon Corp
(Polyethylines/Polyturpines) Transfilm
Precision Laboratories Inc
Preserve
Safer Inc
(Polymer) Safer for Evergreen
UAP Special Products
Blanket, NuFilm
Wilt-Pruf Products Inc
(di-1-p-Menthene) Wilt-Pruf
SEE AD NEXT COLUMN

Bactericide

J J Mauget Co
(Streptomycin) Inject-A-Mycin "S"

TRANSPLANT ANYTIME with
WILT PRUF
ANTI-TRANSPIRANT

maintains moisture in leaves and stems!

Biological Control

Burlington Scientific Corp
(Cytokinens, Humates) Speed Feed Turf Elixir; Speed Feed Turfgrass Formula
Green Pro Services
(Parasitic Nematodes) Scanmask
KLM Bio Systems Inc
Bio Groundskeeper
Maag Agrochemicals Inc
(fenoxycarb) LOGIC Fire Ant Bait
Necessary Trading Co
(B.t) Dipel; (potassium salts of fatty acids) Safer Insecticide Conc; (beneficial nematode) Bio Safe
PBI-Gordon Corp
(Kurstaki) Bactospeisec
Ringer Corp
(Bacillus popilliae) Grub Attack; Flea & Tick Attack; Yard & Garden Insect Attack
Safer Ing
(potassium salts of fatty acids) Safer
Sandoz Crop Protection
Pentac Aquaflo
UAP Special Products Inc
Dipel, Safer

Colorant

Arborchem Products Co
(Proprietary) Bullseye
Becker-Underwood Inc
TURF MARK; (mulch colorant) Mulch Magic; (turf colorant) Green Lawnger
W A Cleary Chemical Co
Greenzit, Super Greenzit, Grass Greenzit, Virginia Pine Greenzit
Jonathan Green Inc
Dyon; Tru-Green Grass Paint
Gustafson Inc
Gustafson Pro-ized
LESCO Inc
(Blue indicator dye) LESCO Tracker
Mallinckrodt Inc
Turf Colorant, Auragreen, Vitalon
Milliken Chemical
(Polymeric) Blazon

Blazon[®]

SPRAY PATTERN INDICATOR

A non-staining colorant for accuracy and safety of pesticide applications.



Nacco
Super Tracer Dye
Nature's Touch
(concentrated cellular gums w/latex base & non fade color) Nature's Touch Green Blades
Precision Laboratories Inc
Signal

When good shots end up in bad lies on dollar spotted fairways, it can spot your course's reputation.

That's good reason to put Rubigan® in play. Dollar for dollar, nothing controls dollar spot better.

Just one Rubigan application controls even resistant strains of dollar spot for up to 28 days. And one case of Rubigan will treat up to 8 acres of greens and fairways.

Rubigan is the only fungicide labeled to treat and prevent all these other turf spoilers, too: Fusarium leaf spot, necrotic ring spot, summer

patch, take-all patch and spring dead spot—plus large brown patch with a Daconil 2787® tank mix.

Keep your fairways, tees and greens dollar spotless—looking clean and beautiful all season long. Get Rubigan from your Elanco distributor. Or call toll-free: **1-800-352-6776.**

Elanco Products Company
A Division of Eli Lilly and Company
Lilly Corporate Center
Dept. E-455, Indianapolis, IN 46285, U.S.A.
Rubigan® — (fenarimol, Elanco)
Daconil 2787® — (chlorothalonil, SDS Biotech)



Circle No. 122 on Reader Inquiry Card

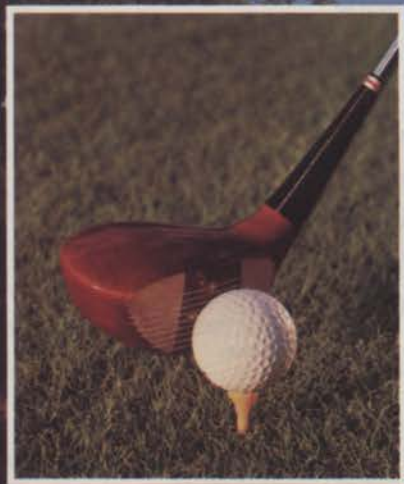

**From
sweet spot**

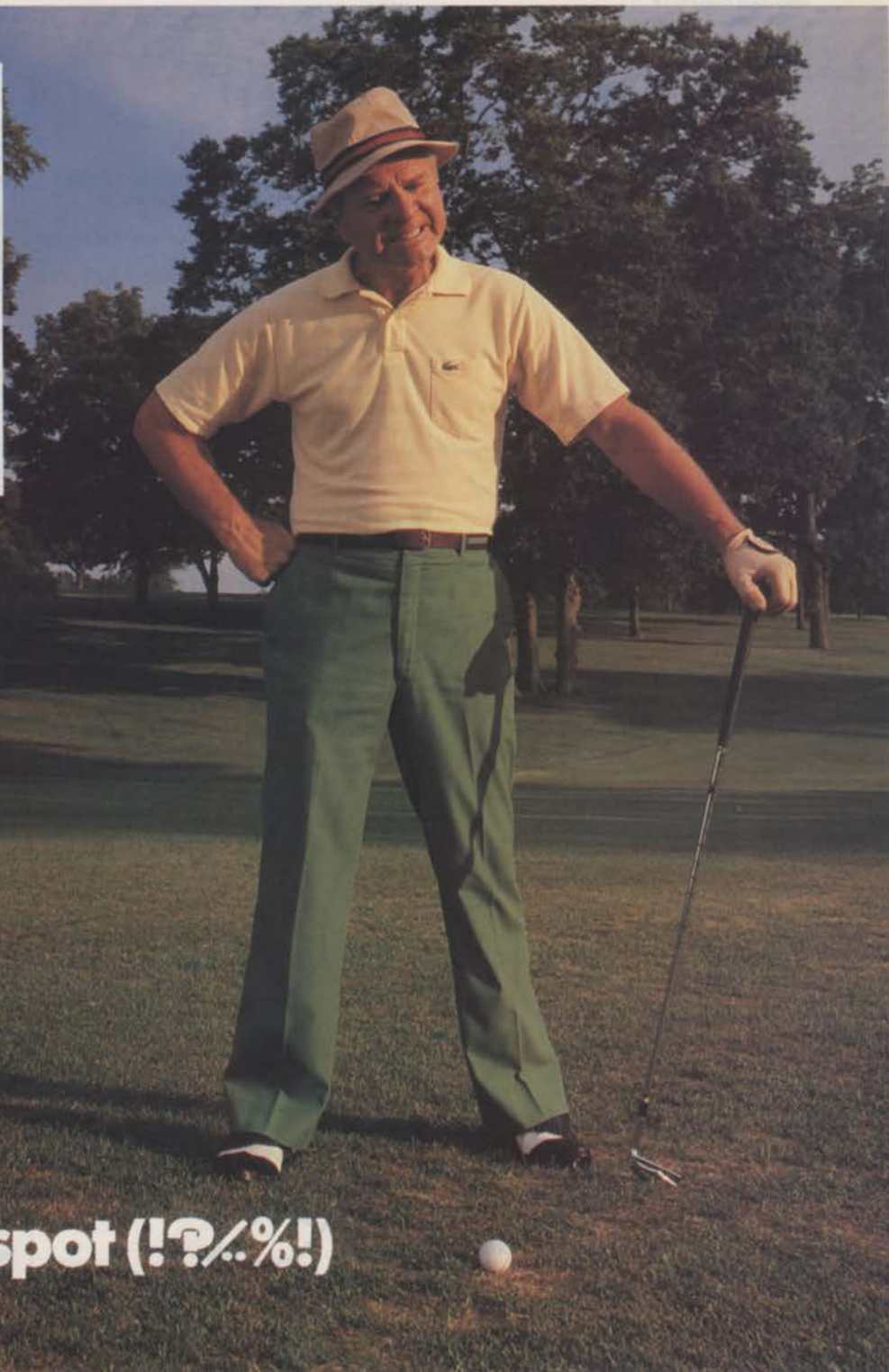

...to dollar spot (!?!%!!)

Chemicals

continued

Royalgard Products Co
Royalgreen; Royalblue
Sierra
Vitalon; Auragreen
Southern Mill Creek Products Co
Blazon; Aquashade
Spectrum Technologies Inc
Sprayguide; Lake Blue
UAP Special Products Inc
Turf Mark, Blazon

Defoamer

Applied Biochemists Inc
(Silicone) Foamtrine
Arborchem Products Co
(10% Silicone) Arborchem Defoamer
W A Cleary Chemical Corp
(silicone base) Cleary's Defoamer
Finn Corp
(silica-in-silicon oil compound) Foam Chek
Jonathan Green & Sons Inc
Gustafson Inc
Gustafson Slurry Defoamer
Kalo Inc
Defoamer & Anti-Foam
LESCO Inc
(Silicone) LESCO Defoamer
Moyer Chemical Co
Anti-Foam, Foam Fighter
Nacco
Antifoam
Precision Laboratories Inc
Knockdown
Royalgard Products Co
(silicone based) De-Foamer
UAP Special Products Inc
Fighter F

Drift Retardant

Arborchem Products Co
(33% Polymer) 38-F; (dry polymer) 41-A
W A Cleary Corp
Cleary's Driftproof
Nalco Chemical Co
Nalco-Trol, Nalco-Trol II, Nalquatic
Nature's Touch
(cellulose thickness) Nature's Touch No Drift
Precision Laboratories Inc
Direct
Southern Mill Creek Products Co
Nalco-Trol; Nalco-Trol II
Spectrum Technologies Inc
Spraytrol
UAP Special Products Inc
Chemtrol

Fertilizer, Tree

J & L Adikes Inc
Eeesy-Grow
Andersons
CoRoN Corp
(amine-modified polymethylene urea 28-0-0, 70% CRN) CoRoN controlled release nitrogen;
Creative Sales Inc
(N-P-K, Fe, Mn & Zn) MEDICAP Systemic tree implants
Doggett Corp
(slow release soluble) XL-Injecto Feed 32-7-7 & 12-24-24, Evergreen Special 30-7-10
Garfield Williamson Inc, Proform Turf Products Div
(release nitrogen, added micronutrients) PROFORM 12-24-12 Winterizer
Great Salt Lake Minerals & Chemicals Corp
(Sulfate of Potash) GLS
Jonathan Green Inc
34-3-7 8.5% WIN

Green Pro Services
(NPK, Humus, trace elements) Vita Tree/Shrub
Growth Products Ltd
(Methylene diurea, MAP, Potassium Nitrate) 18-3-6 with Micros 50% CRN
Haifa Chemicals Ltd
(potassium nitrate 13-0-46) K-Power
Hawkeye Chemical Co
(controlled release liquid nitrogen) Formolene LU
Howard Johnson Ent Inc
(RZP)
LaRoche Industries Inc
Vertagreen, Soilife, Supreme Green
Lebanon Total Turf Care
Lebanon, Turfmaster, (Melamine) Nu-Tech
Leffingwell
Vitaton Stabilized, Vitaton Sorba-Spray, Nutra-Phos, Nutra-Spray
LESCO Inc
LESCO 16-10-9 Tree Stakes, LESCO 8-10-10 "Hi" Trace Element Tree Stakes, LESCO Arbor Green
J J Mauget Co
(Chelated Ag Minerals & NPK) Stemix; (Sulfates & Nitrates) Inject-A-Min Fe-Zn, Inject-A-Min Mn
MCI AgSystems
(Triamino-triazine) Nitrazine 66N
Milorganite
(N, P & iron with micro's) Milorganite
Moyer & Son Inc
(liurea, Methylene ureas, polyphosphates Muriate of potash) Arborflo; (urea, polyphosphates, muriate of potash) Rootflo
Moyer Products Inc
(20-9-9) Super Blend; (20-20-20) Verdisol; (32-10-10, 12-26-26) Four Seasons
Na-Churs Plant Food Co
(nitrogen & P & K) Na-Churs Liquid Fertilizer 15-3-4 & 21-3-4; (liquid nitrogen) CoRoN 28-0-0
Nature's Touch
(Natural vegetative extract base blended with Primary, secondary micronutrients) TES
NOR-AM Chemical Co
(Ureaform) NitroForm
Par Ex
(Isobutylidene Diurea) Woodace
Plant Marvel Laboratories Inc
(tree & shrub special 25-15-10) Plant Marvel
R G B Laboratories Inc
(micronutrients, iron) Agri-Plex For-X; (Iron) Agri-Plex FE & Lawn-Plex
Ringer Corp
(Feather meal, blood meal) Evergreen Booster; (bone meal, wheat germ) Deciduous Tree Booster; (muriat of potash) Tree Restore
Roots Inc
(marine algae extract, humic acid, metabolizers, co-enzymes) Roots

**7 ways
Precision Laboratories
can help you...**

DIRECT™
Drift Retardant

PEN-A-TRATE™
Wetting Agent

SIGNAL™
Spray Colorant

CHEM-STICK™
Spreader/Sticker

BALANCE™
pH Adjuster

INCIDE-OUT™
Tank Cleaner

TRUE BLUE™
Lake & Pond Dye

**We offer
dozens more**

Circle No. 154
on Reader
Inquiry Card

Precision's complete line of turf products improves your performance. See your distributor or call.

Precision Laboratories, Inc.
P. O. Box 127
Northbrook, IL 60065
1-800-323-6280

PRECISION
PRODUCTS FOR GROWTH

ROOTS™

Reduces Loss in Transplanting
and Sod Installation

ROOTS Inc.

(Natural root growth biostimulant
for all turfgrass and plants)

Ruffin Inc
(4% nitrogen, 5% sulphur, 10% iron) Ruffin Turf
Chelated Iron Granules
Sierra
Agriform
Southern Mill Creek Products Co
Nutrex 20-20-20
Sustante Corp
(dry granular organic compost turkey litter) Sustane
UAP Special Products Inc
NuLeaf
Uniroyal Chemical
(Foliar Nutrients) Nutra-Phos, Sorba-Spray
Vigoro Industries Inc
IBDU; Escote; Woodace



Keep your reputation
spotless.

Golfers may not know leaf spot by name, but it can mark the difference between your course and someone else's.

DYRENE® 4 Turf Fungicide has been effectively controlling leaf spot for years. And for every day of control you get, nothing costs less.

DYRENE 4. Proven control. Because we have a reputation to consider, too. For more information, contact Mobay Corporation, Specialty Products Group, Box 4913, Kansas City, MO 64120.

Dyrene 4

Mobay Corporation
A Bayer USA INC. COMPANY



DYRENE is a Reg. TM of Mobay Corporation.

©1989 Mobay Corp. 74521

Circle No. 141 on Reader Inquiry Card

continued

Fertilizer, Turf

J & L Adikes Inc
(20-6-9.6% slow release/weed & feed/& w Team) Pro-Gram (Grow-Well)
Andersons
Tee Time; Professional Custom Mix; Break-Thru



Arcadian Corp
(Triazone Nitrogen) N-Sure
W A Cleary Chemical Corp
(Ureaform) Fluf 18-0-0, Fluf 10-0-10, Fluf 16-2-4, Cleary's Water Soluble Fertilizer
CoRoN Corp
(amine-modified polymethylene urea 28-0-0, 70% CRN) CoRoN controlled release nitrogen

Bridge Your Nitrogen Valleys with CoRoN's Longer Release Time!

We are offering the newest and most improved of the liquid low-burn, controlled release nitrogen fertilizers.

CoRoN provides more controlled release nitrogen and lower burn potential to give you superior performance. CoRoN is storage stable and has low burn volatility of nitrogen to atmosphere.

CoRoN provides quick green-up, promotes even turf growth over a longer period of time, is compatible with commonly available turf protection products and is easily blended into N-P-K liquid fertilizers by normal means.

CoRoN is excellent in low volume systems which saves time and money in labor and equipment costs.

CoRoN's 28-0-0 analysis and unique two-step manufacturing process allows CoRoN to give dry methylene urea performance on turf with the efficiency of liquid handling.

Call us today for complete details on how CoRoN can help you bridge both your performance and profit valleys.

P.O. Box 198
Souderton, PA 18964
800-338-0836
215-723-5099



A New Force In Lawn Care

Distributor's Own Turf Supplies
Distributor's Own

Doggett Corp
XL Turf Special 28-7-14; & Total 35-5-6

SEE AD NEXT COLUMN

Garfield Williamson Inc Proform Turf Product Div
(controlled release N with Nitroform, SCU, UF, MDU, active sludge) PROFORM 30-5-7, PROFORM 20-5-7

Jonathan Green Inc
New Vigor, Spring Green-Up, Super Green-Up, New Seeding, Winter Survival, Twin Green, Turf Tonic, Hydroseeding

Green Pro Services
(secondary/micro nutrients) Vita Green; (humus, humic acid trace) Vita Build



**THE DOGGETT CORPORATION
FERTILIZER SOLUTIONS INC.**

30 Cherry St.
Lebanon, NJ 08833
TEL: 201-236-6335

Products/Services Offered:
Fertilization Equipment
Fertilizers
Soil Conditioners & Amendments

XL-INJECTO FEED TREE FERTILIZERS

Product Type: Fertilizers

Description:

These water-soluble slow-release tree fertilizers, when hydraulically injected into the soil, last up to one full year. The analysis is low in salt, chloride-free and contains iron, copper, manganese and zinc. These tree fertilizers come in varying formulas to suit specific trees and conditions.

Contact: Roger D. Mellick, Vice President

Growth Products Ltd

(Methylene diurea) Nitro-26 CRN; (chelated FE, ZN, CU, MN chelated EDTA, Methylene Diurea, MAP, Potassium, nitrate) Micrel 18-3-6 with micros 50% CRN



P.O. Box 1259
White Plains, N.Y. 10606
Customer Service
1-800-648-7626
(914) 428-1316

Manufacturers of high quality liquid slow release fertilizers for turf, tree and ornamental applications.

Haifa Chemicals Ltd
(potassium nitrate 13-0-46) K-Power
Hawkeye Chemical Co
(controlled release liquid nitrogen) Formolene LU
Howard Johnson Ent Inc
(custom blends)
LaRoche Industries Inc
Vertagreen, Soilife, Supreme Green
Lebanon Total Turf Care
Lebanon, Country Club, Greenskeeper, Lebanon Pro, Green Gold, Turfmaster
Leffingwell
Vitaton Stabilized, Vitaton Sorba-Spray
LESCO Inc
(Multiple types and blends) LESCO
MCI AgSystems
(Triamino-triazine) Nitrazine 66N
Milorganite
(N,P & iron with micro's) Milorganite
Milwaukee Metropolitan Sewerage District
(6-2-0 Natural Organic) Milorganite
Moyer & Son Inc
(Urea, polyphosphates, Muriat of potash) Turflo

Moyer Products Inc
(20-9-9) Super Blend; (20-20-20) Verdisol; (32-10-10, 12-26-26) Four Seasons

Nacco
Grow More
Na-Churs Plant Food Co
(nitrogen, Phosphorus, Potassium) Na-Churs Liquid Fertilizer 15-3-3 & 16-2-3; (Nitrogen & potassium) Na-Churs Liquid Fertilizer 15-05; (liquid potassium) Na-Churs Liquid Fertilizer 0-0-30; (controlled release nitrogen, phosphorus, potassium) Na-Churs Liquid Fertilizer 15-3-4 & 21-3-4; (controlled released nitrogen) CoRoN

Nature's Touch
(Primary, secondary micronutrients) Strengthen & Renew

Necessary Trading Co
(soil inoculant, kelp meal) Soil Vitalize; (granular compost) Sustane 5-2-4; (soluble kelp extract) FoliaGro

NOR-AM Chemical Co
(Ureaform) Nitroform; (Methylene Urea Polymers) Nutralene

Par Ex
(Isobutylidene Diurea) Par Ex

PBI-Gordon Corp
(6% iron) Ferromec; (6% iron amine compatible) Ferromec AC; (6% iron plus manganese) Ferromec M; (6% iron plus manganese amine compatible) Ferromec MAC (Processed cow slurry) Bov-a-Mura

Plant Marvel Laboratories Inc
(Bent special 28-8-18, Bermuda special 25-5-20, Lawn Marvel 28-18-8) Plant Marvel

R G B Laboratories Inc
(micronutrients, iron) Agri-Plex For-X; (Iron) Agri-Plex FE & Lawn Plex

Unequaled Micronutrient Technology



1531 Charlotte Street, Kansas City, Missouri 64108
Telephone: 816/474-3342

Ringer Corp
Turf Restore, Lawn Restore
Roots Inc
(marine algae extract, humic acid, metabolizers, co-enzymes) Roots
Royalgard Products Co
(Iron, nitrogen, sulfur) Armor, Armor Plus
Ruffin Inc
(6% nitrogen, 6% Iron, 2% manganese) Tuff Iron Special; (15% nitrogen, 6% iron) Turf Iron
O M Scott & Sons Co
(Methylene Ureas, Urea, Ammuniated phosphate, potassium sulfate) Proturf HD Fairway, Proturf Fluid Greens; (Sulfur-llated Ures, Urea, Ammuniated Phosphate, Potassium chloride) Proturf Fertilizer; (Triazone, Urea, Potassium purophosphate) Proturf Fluid Fertilizer
Sierra
Agriform; Customblen
Southern Mill Creek Products Co
Nutrex 20-20-20
Sustane Corp
(dry organic granular compost turkey litter) Sustane

SUSTANE

A Natural Organic Fertilizer

Sustane Corporation
1107 Hazeltine Blvd., Chaska, MN 55318
(612) 448-8828

Triazone Corp
(urea triazone) N-Sure
UAP Special Products Inc
UAP



NUTRALENE

The New Name in NITROGEN!

This advanced controlled-release material derived from methylene urea polymers is the ideal nitrogen source for all your turf needs. That's because NUTRALENE™ works **two** ways. First, it provides a quick-release nitrogen through hydrolysis. Second, NUTRALENE releases nitrogen more slowly through microbial action for sustained feeding. This dual action (the result of its unique molecular structure) makes NUTRALENE the superior controlled release nitrogen source. The following points show that NUTRALENE meets all the professional's requirements for a broad-use nitrogen.

This quality nitrogen source offers...

- Quick greenup
- Controlled-release nitrogen feeding for up to 16 weeks
- Both hydrolysis and microbial action— not dependent on coating or particle size for release
- Minimal leaching and volatilization
- Consistent release of all nitrogen in one growing season, under all conditions, even during cool soil temperature situations
- Low salt and low burning potentials
- 40-0-0 guaranteed analysis



3509 Silverside Road, P.O. Box 7495, Wilmington, DE 19803

IMPORTANT: Please remember always to read and follow carefully all label directions when applying any chemical.

Copyright © 1989 NOR-AM Chemical Company. All rights reserved.

Circle No. 147 on Reader Inquiry Card

Nothing else keeps y

The New Name in NITROGEN!

- 40-0 guaranteed analysis
 - Low salt and low burning potential
 - Consistent release of all nitrogen in one growing season, under all conditions, even during cool soil temperatures
 - Minimal leaching and volatilization
 - Both hydrolytic and microbial action— not dependent on coating or particle size for release
 - Quick Greenup
- This quality nitrogen source offers...

This advanced controlled-release material derived from hydrolytic urea polymers is the ideal nitrogen source for all year-round needs. That's because NUTRALINE™ works two ways. First, it provides a quick release nitrogen through hydrolysis. Second, NUTRALINE releases nitrogen more slowly through microbial action for extended feeding. The dual action (the result of its unique molecular structure) makes NUTRALINE the superior controlled-release nitrogen source. The following points show that NUTRALINE meets all the professional's requirements for a broad-use nitrogen.

WINDOR-AM
NORVAM CHEMICAL COMPANY
A Division of Dow Chemical

2000 Shreve Road, P.O. Box 142, Wilmington, DE 19807

WINDOR-AM, NUTRALINE, and the Windor-AM logo are registered trademarks of Dow Chemical Company. All other trademarks are the property of their respective owners.

our course this clean.



© 1988 CIBA-GEIGY Corporation, Turf and Ornamental Products, Box 18300, Greensboro, NC 27419. Always read and follow label directions.

Circle No. 111 on Reader Inquiry Card

Chemicals

continued

Triazone Corp
(liquid urea triazone nitrogen source) N-Sure
Uniroyal Chemical
(Foliar Nutrients) Solu-Spray, Vitatone Iron
Vigoro Industries Inc
IBDU; IBDU/SCU; Par Ex
Warren's Turf Nursery Inc
(10-8-4(15) All Purpose Lawn Food; (6-20-20) Lawn
Starter; (18-5-8) Slow Release; (25-3-9) Timed
Released IBDU; (25-3-9) Weed & Feed

Fungicide, Tree

Elanco Products Co
(Fenarimol) Rubigan
Fermenta ASC Corp
(Chlorothalonil) Daconil 2787 Flowable, Daconil 2787
W-75, Daconil 2787 WDG
Kincaid Enterprises Inc
(Chloroneb) KE Terraneb SP
LESCO Inc
(Mancozeb) LESCO; (Maneb, Zinc) LESCO 4 Flowable
with Zinc
Mallinckrodt Inc
(Zn, Mn, Thiophanate Methyl) Zyban
J J Mauget Co
(DEBC) Fungisol; (Oxycarboxin) Fungisol PV
Mobay Corp
(Triadimefon) Bayleton
PBI-Gordon Corp
(chloroneb) Teremec SP; (fore) Formec
Sierra
Duo San
Safer Inc
Safer Garden Fungicide
Southern Mill Creek Products Co
Tersan 1991

UAP Special Products Inc
Captam, Mancozeb
Valent USA Corp
(Triforine) VALENT Triforine EC

Fungicide, Turf

J & L Adikes Inc
Benomyl, Bayleton, Tersan 1991
Andersons
CelPril Industries
(Seed coating) Apron
Ciba Geigy Corp
(Metalaxyl) Subdue; (Propiconazole) Banner; (Metalaxyl/
Mancozeb) Pace
W A Cleary Chemical Corp
(Thiram) Spotrete; (Topsin M) 3336; (Phenylmercuric
acetate) PMA5; (Caddy) Cadmium chloride
Distributor's Own Turf Supplies
(Bayleton) Distributor's Own
E I DuPont de Nemours & Co
(Benomyl) Tersan 1991 DF; (Mancozeb) Tersan LSR
Elanco Products Co
(Fenarimol) Rubigan
Fermenta ASC Corp
(Chlorothalonil) Daconil 2787 Flowable, Daconil 2787
W-75, Daconil 2787 WDG
Gustafson Inc
(Metalaxyl) Gustafson Apron-FL, Apron 25W, Apron
12.5% dust Seed Treatment
Jonathan Green Inc
Banol, Bayleton, Chipco Flo, Daconil 2787, Dyrene,
Tersan 1991
Howard Johnson Ent Inc
(Bayleton)
Kincaid Enterprises Inc
(Chloroneb) Terraneb SP

For Country Club Quality Turf... Tee Off With TERRANEB SP.

TIME TESTED
TERRANEB SP
TURF FUNGICIDE

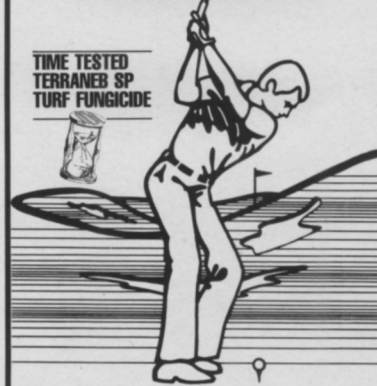

For more information, write



**KINCAID
ENTERPRISES**

P.O. Box 549 NITRO, WV 25143 or call your local dealer.

Your old fertilizer formula may get the job done.

Most distributors can only offer you stock answers. You have to choose from the product line they have in-stock.

But DOTS offers you something uniquely different.

Your DOTS distributor will provide custom-blended formulas to match your particular soil needs, climate and grass conditions.

We then offer personalized service

Lebanon Total Turf Care

(Bayleton (Tridemefon)) Lebanon; (Daconil 2787 (Chlorothalonil)) Green Gold, Lebanon; (Benomyl) Lebanon

LESCO Inc

(Mancozeb) Lesco (PCNB) LESCO PCNB 10%; LESCO 1.0% Bayleton; (Thiram) LESCO Thiram 75DG; LESCO Benomyl DG

Mallinckrodt Inc

(Mercuric Chloride, Mercurous Chloride) Calo-Clor, Calo-Gran; (Cadmium Succinate) Cadminate; (Zn, Mn EBCD, Thiophanate Methyl) Duosan; (Thiophanate Methyl) Fungo 50; (Cadmium Sebecate, Potassium Chromate, Thiram) Kromad; (Ethazol) Koban 30, Koban 1.3G; (Thiram) Thiramad

Mobay Corp

(Triadimefon) Bayleton; (Anilazine) Dyrene

NOR-AM Chemical Co

(Propamocarb) Banol

PBI-Gordon Corp

(Chloroneb) Teremec SP (Fore) Formec 80

Rhone Poulenc-Ag Co

(Iprodione) Chipco 26019; (Aluminum Tris) Chipco Ailette

Rigo Co-Black Leaf Products Co

(Mancozeb) Black Leaf Fore

Royalgard Products Co

(Thiophanate Methyl) Chariot; (mancozeb) Shield

O M Scott & Sons Co

(Thiophanate-methyl, Iprodione) Proturf Fluid Fungicide; (PCNB) Proturf FF II; (Tiladimefon, Metalaxyl) Proturf Fluid Fungide II;

Sierra

(Thiophanate methyl) Fungo; (Vinclozolin) Vorlan; (Mancozeb & Thiophanate methyl) Duo San; (Mercuries) Calo-Clor & Calo-Gran; (Thiram) Thiramad



Southern Mill Creek Products Co

Daconil 2787; W-75; Chipco 26019; Dithane F-45

UAP Special Products Inc

(PCNB) Mancozeb, Tersan, Daconil, Sulsdue, Banner Uniroyal Chemical (PCNB) Turfcide, Terraclor; (Etriazol) Terrazole

Grass Coatings

CelPrial Industries

Nutri-Kote, Nutri-Kote & Apron

Nature's Touch

Green Magic

Growth Regulator

Abbott Laboratories

(Gibberellic acid) PRO-GIBB

Andersons

Arborchem Products Co

(NAA) Sprout Gard

Burlington Scientific Corp

(Kinetin Gibberellic Acid Auxins) Auxinal

Chevron Chemical Co

(Uniconazole) Ortho Prunit

Elanco Products Co

(Fluprimidol) Cutless

Fermone Chemicals Inc

(Cytokinins) Burst Yield Booster

Leffingwell Uniroyal Chemical

(Chlorflurenol) Maintain CF-125, Maintain A

LESCO Inc

A-Rest, Embark, Florel, LIMIT, Bonzi, Cutless 50W

Maag Agrochemicals Inc

(sodium dikegulac) Atrimmec-Gordon's

Monsanto Co

(Amidochlor) Limit

Nature's Touch

Force

PBI-Gordon Corp

(Dikegulac sodium) Attrimec; (mefluicide) Embark PGR

Roots Inc

(marine algae extract, humic acid, metabolizers, co-enzymes) Roots

O M Scott & Sons Co

(Paclobutazol, Methyleneureas, ammoniated phosphate, potassium sulfate) Proturf Fertilizer with TGR Pla annual control, Proturf Hybrid Bermuda TGR Plus Fertilizer

UAP Special Products Inc

Limit

Uniroyal Chemical

(Maleic hydrazide) Royal Slo-Gro; (Daminozide) B-Nine SP

Herbicides, Aquatic

Andersons

Applied Biochemists Inc

(Diquat) Weedtrine-D; (2,4-D granular) Weedtrine II

Chevron Chemical Co

(Diquat Dibromide) Diquat Herbicide-H/A

Elanco Products Co

(Fluridone) Sonar

LESCO Inc

Sonar AS, Sonar SRP, Lescocide-Plus



DOTS custom-blends will do it perfectly.

providing helpful and timely advice for your concerns. So why use a standard product, when you can use a fertilizer program created specifically for you?

For more information on the DOTS

fertilizer and pesticide program, call 1-800-345-DOTS for the DOTS distributor nearest you.

At DOTS, we help your turf look its best. So you look your best.



Distributor's Own
Turf Supplies™

Circle No. 132 on Reader Inquiry Card

continued

Monsanto
(Glyphosate) Rodeo
PBI-Gordon Corp
(dichlobenil) Norosac 10G
Rhone-Poulenc AG Co
(2,4-D) Aqua-Kleen
Southern Mill Creek Products Co
Aquozine; Aquathol K; Hydrothol 191; Rodeo
UAP Special Products Inc
Aquashade Aquathel, Hydrothol
Uniroyal Chemical
(Dichlobenil) Casoron-10G

Herbicides, Nonselective

J & L Adikes Inc
Ureabor, No-Gro
American Cyanamid Agricultural Div
Arsenal
Andersons
Arborchem Products Co
(Bromacil) Clearway
Chevron Chemical Co
(Diquat Dibromide) Diquat Herbicide-H/A
Hoechst-Roussel Agri-Vet Co
(Glufosinate-ammonium) Ignite Herbicide
Jonathan Green Inc
Round-up, Vegemec
Howard Johnson Ent Inc
LESCO Inc
(Sodium metaborate tetrahydrate, sodium chlorate, bromacil) Lescobar, Lescopro Trim, Lescopro Avail
Monsanto
(Glyphosate) Roundup & Expedite
PBI-Gordon Corp
(Prometon 2,4-D) Vegemec; (dichlobenil) Barrier 50-W
Rhone-Poulenc Ag Co
(Amitrole) Amitrol-T
Rigo Co-Black Leaf Products Co
(Pramitol) Rigo's Best Non-Selective Weed Killer; (sodium chlorate, sodium metaborate) Black Leaf Grass, Weed & Veg Killer
Riverdale Chemical Co
(Sodium Chlorate & Sodium Metaborate) Killsalt; (Bromacil & Diuron) DiBro Granular & DiBro 2 + 2; (Velpar L) 1.25% Hexazinone; (Pramitol) Prometon 5E Veg Killer Conc
Southern Mill Creek Products Co
Hyvar; Velpar; Karmes
UAP Special Products Inc
Roundup, Diquat
Uniroyal Chemical
(Dichlobenil) Casoron-10G, 50W

Herbicides, Postemergence

J & L Adikes Inc
Trimec, Roundup
American Cyanamid Co
(Imazaquin) Image
Andersons
BASF Corp, Agricultural Chemicals
(Sethoxydim) Poast; (bentazon) Basagran
W A Cleary Chemical Corp
(Mecoprop) Cleary's MCPP; (Mecoprop + 2,4-D) Cleary's MCPP/2,4-D; (DSMA) Methar 30
Distributor's Own Turf Supplies
Turf weeder with Triamine) Distributor's Own
Dow Chemical Co
(Triclopyr & 2,4-D) Turflon II; (Triclopyr) Turflon; (Chlorpyralid & Triclopyr) Confront
Fermenta ASC Corp
(MCPP + 2, 4-D Amine Dimethylene salt of 2,4-D & MCPP) 2+2; (MSMA) Daconale 6; (MSMA) Bueno 6 (West Coast); (N-Oleyl-1,3-propylene diamine salt of 2,4-D) Dacamine 4D
Jonathan Green Inc
Trimec Classic, Super Trimec, Basagran Acclaim, Trimec Granules, Turflon D, Weedone DPC, DSMA
Hoechst-Roussel Agri-Vet Co
(Fenoxaprop-ethyl) Acclaim
SEE AD NEXT COLUMN
Howard Johnson Ent Inc
(Triamine, 2,4-D Amine & Ester)
LaRoche Industries Inc
(Trimene, weed & Feed) Vertagreen
Lebanon Total Turf Care
(2,4-D & MCPP & Dicamba) Lebanon Pro; (2,4-D, MCPP) Country Club, Green Gold, Turfmaster, Lebanon
LESCO Inc
(2,4-D & 2,4-DP)LESCO, LESCO Weedone DPC; (2,4-D, MCPP & dicamba) LESCO Three-Way; (2,4-D) LESCO A-4D; (MCP) Lescopex; (MSMA) LESCO MSMA 6.6; LESCO Image, LESCO TFC, LESCO Moss & Algae Eraser
Mallinckrodt Inc
(Dicamba, 2,4-D, MCRP) Trexan
Mobby Corp
(metribuzin) Sencor
Monsanto
(MCPP, 2,4-D) Expedite Broadleaf Herbicide
NOR-AM Chemical Co
(Ethofumesate) Progress
PBI-Gordon Corp
(Esters of 2,4-D & 2,4-DP + Dicamba) Super Trimec; (2,4-D, MCPP + Dicamba, MSMA) Trimec Plus; (2,4-D MCPP, dicamba) Trimec Broadleaf Herb; (Fluazifop) Ornamec Grassy Weed Herb; Southern Trimec
Rhone-Poulenc-Ag Co
(2,4-D, 2,4-DP) Weedone DPC; (Asulam) Asulox
Rigo Co-Black Leaf Products Co
(MSMA) Rigo's Best Crabgrass killer; (Eptam) Black Leaf Eptam Weed Control
Riverdale Chemical Co
(MCPA, MCPP & 2, 4-DP/Amine) Triamine II, Par 3 & Triamine Granular Weed Killer & Jet-Spray Spot Killer; (2,4-D Amine) Weeddestroy AM-40, Turf Weeddestroy D; (2,4-D, MCPP & 2,4-DP/Amine) Triamine; (2,4-D/MCPP & 2,4-DP/IOE) Tri-Ester; (MCPA, MCPP & 2, 4-DP/IOE) Tri-Ester II; (2,4-D & 2,4-DP/IOE) Turf D + DP, Brush Killer; (Mecoprop/Amine) Weeddestroy MCPP, MCPP-4; (Mecoprop/ IOE) MCPP L.V. Ester; (2,4-D & Dichlorprop) 2 D + 2 DP Amine;(Mecoprop IOE) MCPP L V Ester; (MCPA) MCPA-4; (Dichlorprop/IOE) DP 4 Ester; (2,4-D IOE) 2,4-D Granules; (2,4-D & MCPP IOE) Granular Lawn Weed Killer
Royalgard Products Co
(2,4-DP, MCPP, MCPA) Sabre
O M Scott & Sons Co
(2,4-D, MCPP & Dicamba) ProTurf Fertilizer with Dicet weed Control III; (Atrazine, Methylene ureas, Urea, Ammuniated Phosphate, Muriate of potash) Proturf St

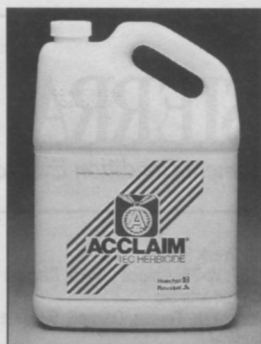

ACCLAIM.®
Because
your turf is always
on display.

Acclaim and the name and logo HOECHST are registered trademarks of Hoechst AG. The name and logo ROUSSEL are registered trademarks of Roussel Uclaf S.A.



Marketed by: Hoechst-Roussel Agri-Vet Co., Somerville, NJ 08876

Augustine Weed Control plus Fertilizer; (Dicamba) Proturf K-O-G
Sierra
(MCP, Dicamba, 2-4 D) Trex-San Broadleaf
Southern Mill Creek Products Co
Roundup; MSMA 6.66
UAP Special Products Inc
MecAmine - D, Four Power Plus

UAP

THE SOURCE.

For
Professional Turf Care Products

Fertilizers	Insecticides
Herbicides	Fungicides
Irons	

NE WATS: 1-800-642-TURF
Natl WATS: 1-800-228-0096
1-402-727-8689

UAP

Special Products
P.O. Box 1467
Fremont, NE 68025

Uniroyal Chemical
(Dichlobenil) Casoron-2G, 4G
Valent USA Corp
(Diquat dibromide) Valent Diquat Herbicide HIA

Herbicides, Preemergence

J & L Adikes Inc
Balan, Team Casoron, Treflan
American Cyanamid Co
(Pendimethalin)
Andersons
Ciba Geigy Corp
(Metalachlor) Pennant
Distributor's Own Turf Supplies
(crabgrass control plus fertilizer with Team, Balan, Surfian, XL, Tupersan or Dacthal) Distributor's Own
Elanco Products Co
(Oryzalin) Surfian; (Benefin) Balan; (Oryzalin + Benefin) XL; (Benefin, Trifluralin) Team; (Trifluralin) Treflan
Fermenta Plant Protection Co
(DCPA) Dacthal Flowable, Dacthal W-75
Jonathan Green Inc
Balan, Dacthal, 20-5-5 w/Pendimethalin, Fertilizer Plus Team, New Seeding Plus Tupersan
ICI Americas Inc
(Bensulide) Betusan; (Propionamide) Devrinol; (Dipropylthiocarbamate) Eptam
Howard Johnson Ent Inc
(Team, Dacthal, Balan, Dryzalin, Excel, Tupersan, Betasan)
LaRoche Industries Inc
(Team, Balan, Ronstar) Vertagreen
SEE AD NEXT PAGE
Lebanon Total Turf Care
(Benefin) Country Club, Lebanon, Turfmaster, Green Gold; (Bensulide) Lebanon, Country Club; (DCPA) Lebanon, Country Club; (Oxidiazon) Country Club; (Benefin & Trifluralin) Country Club, Green Gold, Lebanon Pro; (Trifluralin) Lebanon, Green Gold; (Siduron) Lebanon, Green Gold; (Oryzalin) Country Club;
LESCO Inc
LESCO Pre-M, LESCO, Lescosan 4E, Lescosan 7G, LESCO Dacthal 5G, LESCO 2.5 benefin
Mallinckrodt Inc
(Bensulide) Presan
Mobby Corp
(metribuzin) Sencor
NOR-AM Chemical Co
(Ethofumesate) Progress

LANDSCAPE MANAGER OF THE YEAR

co-sponsored by

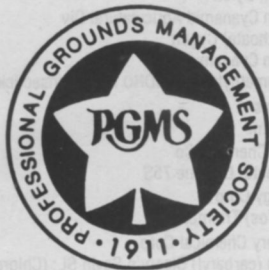

LANDSCAPE MANAGEMENT



1988 Landscape Manager of the Year
Roy Peterman

Entry forms are now being accepted by the Professional Grounds Management Society and LANDSCAPE MANAGEMENT magazine for their third annual "Landscape Manager of the Year" award.

The purpose of the award is to recognize superior job performance among landscape managers, to challenge those involved in the industry, to achieve higher standards of excellence and to bring national recognition to deserving managers.

Any person directly responsible for the professional maintenance of one or more landscapes is eligible to enter. Applicants will be judged according to job performance, honors and awards, procedures and philosophies, and contributions to the green industry. Applicants will be asked, at the time of entry, to submit four 5 x 7 black-and-white glossy photos and 10 color 35mm slides of current work areas with a short narrative on each.

(clip and mail)

Applicant's name

Title

Applicant's company

Official entry form should be sent to:

Name

Title

Company

Address

City/State

Zip Code

Mail to: PGMS, Landscape Manager of the Year, 1201 Galloway Ave., Suite 1E, Cockeysville, MD 21030, 301-667-1833

continued

verta·green.

**TOP PERFORMANCE TURF
FERTILIZERS**

*FORMULATED TO MEET
YOUR REQUIREMENTS*

*Fertilizers / Herbicides /
Insecticide Combinations /
Granular Insecticides and
Herbicides*

Birmingham, AL (205)841-1724	Greensboro, NC 1-800-833-01438
Davenport, FL 1-800-338-6947	Sterrett, TX 1-800-325-6798

**LaRoche
INDUSTRIES INC.**



Talstar
Insecticide/Miticide

For broad spectrum ornamental insect control in greenhouses and outdoors.

Talstar has a Section 24(c) "Special local need" registration for use on outdoor ornamentals in AR, CO, CT, NJ, NM, DE, IA, LA, MO, NC, OR, TN; VA, and WA. Consult your local representative or the Talstar label for details.

Talstar and **FMC** are registered trademarks of FMC Corporation.

©1989 FMC Corporation

Insecticides, Turf

- Abbott Laboratories
(Bacillus thuringiensis) DIPEL
- J & L Adikes Inc
Oftanol, Dylox
- American Cyanamid Agricultural Div
(Dimethoate) Cygon
- American Cyanamid Co
(Hydramethylnon) AMDRO fire ant insecticide
- Andersons
Tee Time
- Chevron Chemical Co
(Acephate) Orthene 75S
- Ciba Geigy Corp
(Isazofos) Triumph
- W A Cleary Chemical Corp
(Sevin (carbaryl) Cleary's Sevin SL; (Chlorpyrifos) Dursban 2E; (Chlorpyrifos) Dursban 50W
- Cumberland Intl Corp
(Carbaryl) Crunch
- Distributor's Own Turf Supplies
(Diazinon, Dursban, Oftanol, Dylex & Tupersan)
Distributor's Own
- Dow Chemical Co
(Chlorpyrifos) Dursban
- Jonathan Green Inc
Dursban, Fertilizer + Oftanol, Mocap, Dylox, Oftanol, Sevin, Turcam, Proxol fertilizer + Dursban
- LaRoche Industries Inc
(Trichlorofon, Diazinon, Dursban) Vertagreen
- Lebanon Total Turf Care
(Chlorpyrifos) Country Club, Green Gold, Turfmaster, Lebanon, Lebanon Pro; (Isofenfos) Lebanon, Country Club; (Dimethyl Phosphonate) Lebanon; (Diazinon) Lebanon; (Isofenfos) Lebanon, Country Club, Lebanon Pro; (Carbaryl) Lebanon

- PBI-Gordon Corp
(Dichlobenil) Norosac 4-G, Dyclomec 4-G; (Bensulide) Bensumec
- Rhone-Poulenc Ag Co
(Oxadiazon) Chipco Ronstar
- Rigo Co-Black Leaf Products Co
(Dacthal) Rigo's Best Weed Granules; (Treflan) Rigo's Best Garden Weed Granules
- Royalgard Products Co
(Bensulide) Roysan 4E, 12.5G
- O M Scott & Sons Co
(Pendimethalin, Methylene urea) ProTurf HD Fertilizer Plus Turf Weedgrass Control
- Sierra
(Betasan) Pre-San
- Southern Mill Creek Products Co
Ronstar
- UAP Special Products Inc
Weedgrass Control, Team, XL, Balan, Casaron, Surfian
- Uniroyal Chemical
(Naptalzm) Alanap L

Insecticides, Tree

- Abbott Laboratories
(Bacillus thuringiensis) DIPEL
- J & L Adikes Inc
(Sevin, Malathion, Methoxychlor) Gro-Well
- Chevron Chemical Co
(Acephate) Orthene 75S
- Creative Sales Inc
(Acephate) Acecap 97 Systemic
- Dow Chemical Co
(Chlorpyrifos) Dursban
- F M C Corp Ag Chem Group
(Bifenthrin) Talstar

SEE AD NEXT COLUMN

- LESCO Inc
(Diazinon) LESCO Diazinon 500; (Chlorpyrifos) LESCO Dursban 2.32G
- Mallinckrodt Inc
Bendiocarb, Dycarb, (Diazinon & Methoxychlor) Dymet; (Bendiocarb) Dymet
- J J Mauget Co
(Oxydemeton-methyl) Inject-A-Cide; (Dicotophos) Inject-A-Cide B
- Mobay Corp
(Oxydeneton-methyl) Metasystox; (cyfluthrin) Tempo
- NOR-AM Chemical Co
(Bendiocarb) Turcam & Turcam 2-1/2G
- PBI-Gordon Corp
(Fenitrothion) Pestro
- Prentiss Drug & Chemical Co
(Methoxychlor) Prentox 2lb Methoxychlor Spy; (Diazinon) Pentox Diazinon AG-500 & 50W; (Malathion) Pentox 5lb Malathion Spy
- Reuter Laboratories Inc
(Potassium salts of fatty acids) Aphid-Mite Attack Concentrate
- Rhone-Poulenc Ag Co
(Carbaryl) Sevin
- Rigo Co-Black Leaf Products Co
(Nicotinic Sulphate) Black Leaf 40
- Safer Inc
(Potassium salts of fatty acids) Safer Insecticidal Soap
- O M Scott & Sons
(Pendimethalin) Proturf Turf Fertilizer Plus Preemergent Weed Control; (Pendimethalin) Proturf GO WDG; (Siduron) Proturf Starter Fertilizer with Preemergent Weed Control
- D B Smith & Co
DIPEL
- Southern Mill Creek Products Co
Mavrik; Sevin
- UAP Special Products Inc
Malathion, Safer, Carlsaryl, Mavrik
- Valent USA Corp
(Naled) DIBROM 8 Emulsive; (Lindane) VALENT Lindane #200 Spray; (Acephate) ORTHENS Turf, Tree & Ornamental Spray
- Zoecon Corp-Sandoz Crop Protection Corp
(Fluvalinate) Mavrik Aquaflo

- LESCO Inc
(Trichlorofon) LESCO Dylox 5G; (Diazinon) LESCO Diazinon 500, 5G & 14G; (Chlorpyrifos) LESCO Dursban 2.32G; (Isofenfos) LESCO Oftanol 1.5G; (Carbaryl) LESCO Sevin Brand SL
- Mallinckrodt Inc
Diazinon & Methoxychlor, Dymet
- Mobay Corp
(Trichlorofon) Dylox; (Isofenfos) Oftanol
- NOR-AM Chemical Co
(Bendiocarb) Turcam; (Trichlorofon) Proxol
- PBI-Gordon Corp
(Carbaryl) Carbanec
- Prentiss Drug & Chemical Co
(Chlorpyrifos) Prentox Dursban 4E; (Diazinon) Prenox Diazinon AG-500 & 5G
- Reuter Laboratories Inc
(Spores of bacillus popilliae Dutky) Grub Att ack
- Rhone-Poulenc Ag Co
(Ethoprop) Chipco Mocap 5G; (Carbaryl) Sevin
- Rigo Co-Black Leaf Products Co
(Oftanol) Rigo's Best Turf Saver; (Avermectin) Rigo's Best Affirm Fire Ant Killer
- Royalgard Products Co
(Dimethoate) Cygon 2-E; (Diazinon) Diazinon 5G & 4E; (Chlorpyrifos) Mole Cricket Bait D; (Malathion) Malathion 5E; (Carbaryl) Sevin 4F; (Chlorpyrifos) Dursban 4E & 2.32 G
- O M Scott & Sons Co
(Chlorpyrifos) ProTurf Fertilizer Plus Insecticide III; (Diazinon) Insecticide I; (Isofenfos) Insecticide IV
- D B Smith & Co
(resmethrin) BURGESS
- Southern Mill Creek Products Co
Dursban 2E; Diazinon 4E
- UAP Special Products Inc
Turcam, Durshan, Sevin 10G, Carbaryl, Diazinon, Pentac, Orthene, Triumph
- Valent USA Corp
(Acephate) ORTHENE Turf, Tree & Ornamental Spray; (Methiocarb) SLUG-GETA Granules and Snail & Slug Bait pelleted

Your Business Partner

...Helping grow your business

As a busy lawn care professional, you can't be personally involved with the many critical details that go into making your business successful, details ranging from developing staff safety training programs to keeping abreast of the latest regulatory issues. That's why it is vital that you have the timely information that allows you to be proactive rather than reactive. That's why you need your Business Partner — The Professional Lawn Care Association of America. Let your Business Partner go to work for you on such assignments as:

- **Issues Management**
- **Training programs for pesticide management**
- **OSHA Hazard Compliance**
- **An effective telemarketing program**
- **Preparing a marketing plan**
- **Update on small business law**
- **Group Health/Life/Major Medical**
- **A Credit Collection Service**
- **A Liability Insurance Program**
- **A newsletter on lawn care issues**
- **A public relations program**
- **Gather major suppliers of lawn care products and services**

As the only international trade association of lawn care professionals, PLCAA has a strong history of providing the right information at the right time for the lawn care industry. Our staff and Board of Directors are dedicated to providing you with the professional business assistance you need to stay strong and informed.

To learn more about how to put your Business Partner to work — for less than a dollar per account per year, contact the Professional Lawn Care Association of America today. Clip and mail the return coupon, or call toll free **1-800-458-3466**.



PROFESSIONAL LAWN CARE ASSOCIATION OF AMERICA

1000 Johnson Ferry Road N.E., Suite C-135
Marietta, Georgia 30068-2112
1-404-977-5222 FAX: 404-578-6071



I'm interested! Send me more information on membership in PLCAA

NAME _____
TITLE _____
COMPANY _____
ADDRESS _____
CITY _____ STATE _____ ZIP _____
TELEPHONE _____

CLIP AND MAIL TO:
Professional Lawn Care Association of America, Suite C135
1000 Johnson Ferry Rd NE Marietta GA 30068-2112 LM

Chemicals

continued

Zoecon Corp-Sandoz Crop Protection Corp
(Fluvalinate) Mavrik Aquaflow

Miticides

Mobay Corp
(Oxythioquinox) Morestan
Southern Mill Creek Products Co
Deltic
UAP Special Products Inc
Pentac, Orthene
Uniroyal Chemical
(Propzgrite) Ornamite
Zoecon Corp-Sandoz Crop Protection Corp
(Dienochlor) Pentac Aquaflow

Mulches & Erosion Control

Atlantic Construction Fabrics Inc
(jute mesh fabric) GeoJute; (excelsion blanket/aspen wood) Excel
Becker-Underwood Inc
Mulch Magic

SEE AD NEXT COLUMN

Cellin Mfg Inc
Cellin Fiber Mulch, Cellin-K;(Tackifier) Cellin Seal,
Spooler Fiber Mulch
Grass Growers Inc
Terra Tack I, III, AR, MP
Jacklin Seed Co
Jacklin Organic Mulch
Jonathan Green Inc
Jonathan Green Hydro Seeding Fibermulch, Jonathan
Green Hydrogreen Tackifier, Jonathan Green Super
Tackifier
Hoehst Celanese Corp
(100% Polyester fibers) Earth Blanket

You'll See The Difference!

Mulch Magic™...the inexpensive alternative to replacing faded fibrous mulch products. So easy to handle and use. Mulch Magic restores existing mulch to a vibrant, bright color. Covers herbicide stains, too!

Turf Mark®...the professional's way to apply liquid fertilizers and pesticides. Shows you *exactly* where you've sprayed. Helps eliminate skips and overlaps, saving time and money!

Call today for more information!



Becker-Underwood, Inc.
701 Dayton Avenue • Ames, Iowa 50010
1-800-232-5907

Nature's Touch
(plant/microbial by-products, enzymes, wetting agents) Nutra Aid
North American Green Inc
(Agricultural wheat straw, coconut fibers or combination of both) North American Green
Paygro Co
Paygro Hardwood Mulch
Pro Seed USA
(biodegradable plant fibers) PS 100
PRS Materials Inc
(Vegetative gum based) MulchMate Hydro Tack;
(cellulose based fiber mulch) Quickseed Hydroseeding
Mulch
Reemay Inc
Typar
Soil Seal Corp
(Copolymer of methacrylates & acrylates) Soil Seal
Concentrate
Warren's Turf Nursery Inc
Warren's Terrabond Polyester Geotextile Fabrics
Weyerhaeuser
Silva-Fiber; Silva-Fiber Plus

Nematicides

Jonathan Green Inc
Mocap 5%
Igene Biotechnology Inc
(Chitin-protein complex) Clando San
Mobay Corp
(fenamiphos) Nema-cur
Rhone Poulenc AG Co
(Ethoprop) Chipco Mocap 5G
Southern Mill Creek Products
Mocap; Nema-cur
UAP Special Products Inc
Nema-cur

How to make your career grow.

Join PGMS. GROUNDS MANAGER: The Society treats your career with loving care • **SHARE KNOWLEDGE AND IDEAS** at the Annual Conference and Trade show • **DISCOVER new ideas** every month through the newsletter • **RECEIVE PROFESSIONAL CERTIFICATION:** A peer review may earn you the title of Certified Grounds

Manager • **SURVEYS ON OPERATIONAL PRACTICES** made available to members • \$5,000.00 **accident** and dismemberment **insurance** • **Awards** for outstanding achievement • **WORKSHOPS** give you management skills • **RECEIVE DISCOUNTS** on rental cars and horticultural publications • Estimating Guide, Management Guidelines, Forms and Job Descriptions. Join today. Your career will take root and grow.

Clip and mail to **Professional Grounds Management Society**, 12 Galloway Avenue, Suite 1E, Cockeysville, MD 21030 or phone (301) 667-1833

Professional Grounds Management Society

TO: PROFESSIONAL GROUNDS MANAGEMENT SOCIETY
12 Galloway Avenue
Suite 1E, Cockeysville, MD 21030

YES! I want to give my career a professional edge. Please send more information on what PGMS can do for me.

Name _____

Company _____

Street _____

City & State _____ Zip _____

Area Code and Telephone Number _____



ADD MUSCLE TO YOUR WORK FORCE, GET A BIG BOSS

The term "labor-saving device" might have been coined to apply to the Polaris Big Boss. It's your worker of choice when human hands, arms and backs aren't quite enough, but a pickup or dump truck is too much. And it's a terrific recreational vehicle as well, able to haul an entire campsite in a single trip, or supply a remote hunting cabin with food and equipment for a week. For farms, construction



sites, back yards, or the back woods, a Big Boss gives you the extra strength you need to do what needs to be done.

Warning: ATV's can be hazardous to operate. For your safety: Never carry

passengers, avoid excessive speeds, and be particularly careful on difficult terrain. Polaris ATV's may not be ridden by people under 18 years of age. Polaris recommends that all ATV riders take a training course. For safety and training information, see your dealer or call Polaris at 1(800)328-9975. (In MN, 1(800)247-6670).



POLARIS
Believe It.

continued

Penetrant, Metal

LESCO Inc
(petroleum based) Lesco 4-Way Lubricant
Spectrum Technologies Inc
(penetrating lubricant) Blitz; (grease) Pene-Lube

Repellents, Animal

Burlington Scientific Corp
(Denatonium Saccharide)Ro-Pel; (Vilex) RoPel
Garbage Protect.r
W A Cleary Chemical Corp
(Thiram) Spotrete 75 WDG;(Thiram) Spotrete F
Gustafson Inc
(Thiram) Gustafson Thiram 42-S
Leffingwell
Hinder
Necessary Trading Co
Hinder
Rigo Co-Black Leaf Products Co
(dried blood, tobacco dust, moth balls) Black Leaf Hare
& Hound Repellent; (nicotine sulphate) Black Leaf 40
Uniroyal Chemical
(Ammonium soaps of higher fatty acids) Hinder

Soil Amendments

Aglukon Agri-Products
Viterra; Gelscape
AMPEL
(Pelletized lime & gypsum) Reveille; (Pelletized lime)
Gran U Lime; (Pelletized) Vita Power
W A Cleary Chemical Corp
(sulfur) Sulfur F;(calcium carbonate) Limestone
F;(calcium sulfate) Gypsum F
Doggett Corp
(Elemental sulfur) Nutri-Sul 90

Emerald Isle Ltd
(Sea Plant Meal) Sand-Aid
Grass Growers Inc
Terra Tack I, III, AR, MP
Jonathan Green Inc
Aqua-Grow
JRM Chemical
(Acrylic CoPolymer) Soil Moist; (Acrylic CoPolymer w/
fertilizer) Soil Moist Plus; (Acrylic CoPolymer) Soil
Moist Fines; (Acrylic CoPolymer w/fertilizer) Soil Moist
House Plant Spikes
KLM Bio Systems Inc
Bio Groundskeeper
LESCO Inc
(ferment & polymers) Lescozyme
Nacco
Soil Penetrant, Dust Binder, Spreader 79
Nature's Touch
(plant/microbial by-products, enzymes, wetting
agents; organic micronutrients) Relief
PRSM
(Sewage sludge based soil amendment) Earthlife
compost
Southern Turf Nurseries
(Calcine clay) Terra Green
Sustane Corp
(dry organic granular compost turkey litter) Sustane
UAP Special Products Inc
Turfade

Soil Conditioner

Four Star Agricultural Service
(amonium lureth sulfate) Pene-Turf; (sulfate lureth)
Perk; (sulfate lureth) Li-L Perk
SEE AD NEXT COLUMN
Emerald Isle Ltd
(Sea Plant Meal) Sand-Aid

**Pene-Turf
Soil Treatment...**
The Best Solution For Soil Management

- Eliminates wet and dry spots
- Aids drainage
- Combats erosion
- Helps establish better rooting

For Golf Courses, Athletic Fields and Lawns



FOUR STAR AGRICULTURAL SERVICES, INC.
1-800-348-2608
In IN: 219-824-5384
2275 N. State Rd. One
Bluffton, Indiana 46714

Jonathan Green Inc
granular, pulverized & pelletized limestones, Nutri-Cal
liquid limestone substitute
Green Pro Services
(organic wetting agent) Vita Flow
JRM Chemical
Soil Moist Plus
LESCO Inc
(ferment & polymers) Lescozyme
Miolorganite
(N,P & iron with micro's) Miolorganite
Nalco Chemical Co
Nalco 2190
Nature's Touch
(Plant/microbial by-products, enzymes) Nutra-Aid
PRS Materials Inc
(sewage sludge based compost) Earthlife Compost
Reinco Inc
(tackifier) RMB Plus
Soil Technologies Corp
(Bio-Stimulant-Microbial) TURFtech & TURFtech Plus
Southern Turf Nurseries
(Calcine clay) Terra Green

Soil Fumigants

Hendrix & Dail Inc
(Methyl Bromide/Chloropicrin) MBC concentrate
ICI Americas Inc
(Sodium methylthiocarbamate) Vapam
Rigo Co-Black Leaf Products Co
(Vapam) Black Leaf Vapam
Southern Mill Creek Products Co
Bromogas
Trebtor Corp
(Activated Flowable Charcoal) Flowable Charcoal
UAP Special Products Inc
Basamid

Spill Absorbants

Arborchem Products Co
(dry Flakes) Spill Guard
W A Cleary Chemical Corp
Clear-Sorb, D-Tox
Jonathan Green Inc
Hazorb Pillows
ICI Americas Inc
(Activated carbon) Grosafe
Precision Laboratories Inc
Chemsorb, Petrosorb
Spectrum Technologies Inc
Hazorb; Polysorb

HAZORB®
Universal sorbent

The most efficient and cost-effective absorbent. Available in pillows and in tubes.



Trebtor Corp
(Polymer starch) Soak-Up

Remember when you had to power rake THATCH?



Research at Michigan State University rated Bio-Groundskeeper for Thatch Reduction® most effective for reducing thatch. The easy-to-apply liquid is especially attractive for commercial application: **ALL NATURAL, EASY APPLICATION**, in-tank mixing with fertilizers or herbicides, no fear of moisture damage, **COST SAVINGS.**

Call our toll free 800 # for distributor nearest you.

BIO GROUND'S KEEPER®
For **Thatch Reduction**

KLM Bio-Systems, Inc.
10700 Normandale Blvd.
Bloomington, MN 55437
612-884-4081 1-800-383-4081

Circle No. 135
on Reader
Inquiry Card

Gateway to the '90s

Join the landscape professionals at the 1989 Green Team Conference and Trade Show, "Gateway to the '90s." This four-day event is your entree to a two-day exhibition of the industry's finest products and services. "Gateway to the '90s" is sponsored by the Associated Landscape Contractors of America and the Professional Grounds Management Society and features three full days of educational programs that:

- give you the most up-to-date information on horticultural practices, management techniques and business matters.
- examine in detail subjects ranging from landscape design/build and hydroseeding to sales and contract techniques.

It's four days filled with opportunities to learn — to socialize — to exchange ideas — to see and enjoy. Plan to attend.

Green Team Conference and Trade Show

November 9-12, 1989 ■ St. Louis, Missouri
St. Louis Sheraton and Cervantes Convention Center

Need more information on the 1989 Green Team Conference and Trade Show?



Associated Landscape Contractors of America
405 N. Washington St. #104
Falls Church, Va. 22046
(703) 241-4004

Contact



Professional Grounds Management Society
Suite 1E, 12 Galloway Avenue
Cockeysville, Maryland 21030
(301) 667-1833

See You In St. Louis!

Circle No. 171 on Reader Inquiry Card

continued

Sticker/Extender

Arborchem Products Co
(Proprietary) Clean Cut
Chevron Chemical Co
(Alkyl olefin aromatic polymers) Chevron Spray Sticker
W A Cleary Chemical Corp
(Acrylic base) Clearspray
Finn Corp
(gum & additives) Hydro Stik
Kalo Inc
Bio-Film
LESCO Inc
LESCO Spreader Sticker
Nature's Touch
(plant/microbial by-products, enzymes, wetting agents) Nutra Aid
PBI-Gordon Corp
(polymers, paraffin, naphthenes) Exhalt 800
Precision Laboratories Inc
Chem-Stik
Southern Mill Creek Products Co
(Isooctyl phenyl polyethoxy ethanol) SMCP
UAP Special Products Inc
Bond
Wilt-Pruf Products Inc
Spray-Stay

Tree Dressings

J & L Adikes Inc
Gro-Well
Arborchem Products Co
(NAA) Sprout Gard
LESCO Inc
LESCO Pruning Paint

Wetting Agents

Aquatrols Corp
(Polyoxyethylene) Aqua-Gro
Arborchem Products Co
(80 % Surfactant) Surfactant; (90% surfactant) Aquatic Surfactant
Chevron Chemical Co
(Alkylaryl/polyoxyethylene, glycols, free fatty acids & isopropanol) Ortho X-77
W A Cleary Chemical Corp
Super Wet
Jonathan Green Inc
Aqua-Gro
Green Pro Services
Vita Flow
Kalo Inc
Hydro-Wet Liquid Concentrate, Hydro-Wet TG, Terra Green Granules
Leffingwell
(Non-ionic surfactants) Activate
LESCO Inc
LESCO-WET
Mallinckrodt Inc
Aquadro
Moyer Products Inc
(Alkylaryl/polyoxetethylene Ether) Spray Film B
Nacco
Wetting Agent
Nature's Touch
(Plant/microbial by-products, enzymes) Nutra-Aid
PBI-Gordon Corp
(Oxyethylene) Aqua-Zorb
Precision Laboratories Inc
Pen-A-Trate
Royalgard Products Co
(ethanol) Aquagard L & 15G
Sierra
Hydraflo
Southern Mill Creek Products Co
SMCP Wetting Agent Concentrate
UAP Special Products Inc
Aquatrel
Uniroyal Chemical
Activate
Valent USA Corp
(potassium abietate, potassium oleate, iso-octyl phenoxy-poly-ethoxy ethanol) VALENT Spreader;
(Alkylaryl/polyoxyethylene, glycols, free fatty acids, isopropanol) VALENT X-77 Spreader



4. Chemical Companies

Abbott Laboratories
14th & Sheridan Rd
North Chicago IL 60064
312-937-6100

J & L Adikes Inc
182-12 93rd Ave
Jamaica NY 11423
718-739-4400

Aglukon Agri-Products
50 N Harrison Ave
Congers NY 10920
914-268-2122
800-832-8788

Agri-Diagnostics Assocs
2611 Branch Pike
Cinnaminson NJ 08077
609-829-0110

Agro-Chem Inc
See Nature's Touch

★ American Cyanamid Co
One Wayne Plaza
Wayne NJ 07470
201-831-2000

AMPEL
13 Island Dr
Brick NJ 08724
201-899-2499

Andersons (The)
1200 Dussel Dr
Maumee OH 43537
800-225-2639

Applied Biochemists Inc
5300 W County Line Rd
Mequon WI 53092
414-242-5870
800-558-5106

★ Aquashade Inc
PO Box 198
Eldred NY 12732
914-557-8077

★ Aquatrols Corp
1432 Union Ave
Pennsauken NJ 08110
609-665-1130
800-257-7797

Arborchem Products Co
PO Box 1567
Fort Washington PA 19034
215-659-7922

Arcadian Corp
PO Box 265

Parsippany NJ 07054
201-829-6500

Atlantic Construction Fabrics Inc
9413 Burge Ave
Richmond VA 23237
804-743-9558

Atwater Strong Inc
1355 Evans Ave (44305)
PO Box 1108
Akron OH 44309
216-630-9822

★ BASF Corp
Agricultural Chemicals
100 Cherry Hill Rd
Parsippany NJ 07054
201-316-3000

Becker-Underwood Inc
701 Dayton Rd
Ames IA 50010
515-232-5907
800-232-5907

Burlington Scientific Corp
222 Sherwood Ave
Farmingdale NY 11735-1718
516-694-9000

Cellin Mfg Inc
Box 38
Elkwood VA 22718
703-825-8000

CelPril Industries
251 Oak St
Manteca CA 95336
209-823-1738

Chevron Chemical Co
Agricultural Chemicals Div
575 Market St
San Francisco CA 94105
415-894-6219

★ Ciba Geigy Corp
Turf & Ornamental Products
PO Box 18300
Greensboro NC 27419
919-292-7100

W A Cleary Chemical Corp
1049 Somerset St
Somerset NJ 08873
201-247-8000

CoRoN Corp
113 E Reliance Rd
Souderton PA 18964
800-338-0836

Creative Sales Inc
222 N Park Ave
PO Box 501
Fremont NE 68025
402-727-4800
800-759-7739

Cumberland Intl Corp
1523 N Post Oak Rd
Houston TX 77055
713-682-1221

Dewitt Co
Hwy 61 S
RR 3 Box 338
Sikeston MO 63801
800-325-0950

Distributor's Own Turf Supplies
For the name of the participating distributor nearest you call 800-345-DOTS

Surflan. Roundup. Mix them together, and you've got control that knocks weeds down and keeps them down. Three times longer, in fact, than Roundup alone.

That's what landscapers all across the country are now finding. They are getting better weed control and more satisfied customers. And they're saving time and labor costs because they're applying just once.

With a Surflan/Roundup tank-mix, you get complete control of over 50 different weeds—including such tough species as crabgrass, barnyardgrass, chickweed, spurge, johnsongrass and

foxtail. And Surflan won't harm your nearby landscaped areas, either. It works with little or no lateral movement.

Join the growing list of satisfied users. Add Surflan to your Roundup and stretch your weed control three times longer. See your Elanco distributor for Surflan. Or call toll-free: **1-800-352-6776**.

Elanco Products Company
A Division of Eli Lilly and Company
Lilly Corporate Center
Dept. E-455, Indianapolis, IN 46285, U.S.A.
Surflan®—(oryzalin, Elanco)
Roundup®—(glyphosate, Monsanto)



Circle No. 120 on Reader Inquiry Card

"I can control weeds three times longer just by adding Surflan® to my Roundup®."



Chemical Companies

continued

Doggett Corp
30 Cherry St
Lebanon NJ 08833
201-236-6335

Dow Chemical Co
9001 Bldg
Midland MI 48640
517-636-9843

E I DuPont de Nemours & Co
1007 Market St
Wilmington DE 19898
302-992-6161

★ Elanco Products Co
Lilly Corporate Center
Indianapolis IN 46285
317-276-2679
800-352-6776

Emerald Isle Ltd
2153 Newport Rd
Ann Arbor MI 48103
313-662-2727

Fermenta ASC Corp
5966 Heisley Rd
PO Box 8000
Mentor OH 44061-8000
216-357-4100

Fermone Chemicals Inc
1523 N Post Oak Rd
Houston TX 77055
713-682-1221

★ Finn Corp
9281 LeSaint Dr
Fairfield OH 45014
513-874-2818

F M C Corp
Ag Chem Group
2000 Market St
Philadelphia PA 19103
215-299-6000

Four Star Agricultural Service
2275 N State Rd # One
PO Box 463
Bluffton IN 46714
219-824-5384
800-348-2608
Fax 219-824-1534

Garfield Williamson Inc
Proform Turf Products Div
9 Stewart Pl
Fairfield NJ 07006
201-882-7755

Garick Corp
13532 Broadway Ave
Cleveland OH 44125
216-581-0100

Grass Growers Inc
424 Cottage Pl
Plainfield NJ 07060
201-755-0923

Great Lakes Biochemical Co
6120 W Douglas Ave
Milwaukee WI 53218
414-464-1200

Great Salt Lake Minerals & Chemicals Corp
PO Box 1190
Ogden UT 84402
801-731-3100

Jonathan Green Inc
Squankum-Yellowbrook Rd

PO Box 326
Farmingdale NJ 07727
201-938-7007

Green Pro Services
380 S Franklin St
Hempstead NY 11550
516-538-6444

Growth Products Ltd
PO Box 1259
White Plains NY 10602
914-428-1316
800-648-7626

Gustafson Inc
1400 Preston Rd, Ste 400
Plano TX 75093
214-985-8877

Hawkeye Chemical Co
PO Box 899
Clinton IA 52732
319-243-5800

Haifa Chemicals Ltd
Trans-Resources Chemical Div
250 W 57 St Ste 1111A
New York NY 10107
212-586-0101
Fax 212-586-2332

Hendrix & Dail Inc
803 Industrial Blvd
PO Box 648
Greenville NC 27835
919-758-4263

Hoechst Celanese Corp
PO Box 5887
Spartanburg SC 29304
800-845-7597

Hoechst-Roussel Agri-Vet Co
Rte 202-206 N
PO Box 2500
Somerville NJ 08876
201-231-4084

ICI Americas Inc
2 Righter Pkwy
Wilmington DE 19803
301-886-1135

Igene Biotechnology Inc
9110 Red Branch Rd
Columbia MD 21045
800-346-6421

★ Howard Johnson Ent Inc
PO Box 2990
Milwaukee WI 53201
800-642-4656

S C Johnson and Sons Inc
1525 Howe St
Racine WI 53403-2237
414-631-2000

JRM Chemical
13900 Broadway Ave
Cleveland OH 44125
800-962-4010

Kalo Inc
4370 W 109 St, Ste 210
Overland Park KS 66211
913-491-9125

Kincaid Enterprises Inc
Plant Rd
PO Box 549
Nitro WV 25143
304-755-3377

★ KLM Bio Systems Inc
10700 Normandale Blvd
Bloomington MN 55437
612-884-4081

LaRoche Industries Inc
1100 Johnson Ferry Rd NE
Atlanta GA 30342
404-851-0300

★ Lebanon Total Turf Care
Div Lebanon Chemical Corp
1600 E Cumberland St
Lebanon PA 17042
717-273-1685

Leffingwell Uniroyal Chemical
111 S Berry St
Brea CA 92621
714-529-3973

LESCO Inc
20005 Lake Rd
Rocky River OH 44116
216-333-9250

Maag Agrochemicals Inc
5690 58th Ave
PO Box 6430
Vero Beach FL 32960
407-567-7506

Mallinckrodt Inc
PO Box 5439
St Louis MO 63147
800-325-7155

J J Mauget Co
2810 N Figueroa St
Los Angeles CA 90065
213-227-1482

MCI AgSystems
Div Melamine Chemicals Inc
811 Railroad Ave
Donaldsonville LA 70346
504-473-3121

Milliken Chemical
Box 817
Inman SC 29349
800-845-8502

Milorganite
Div of M M S D
735 N Water St
Milwaukee WI 53203
414-225-2222

Milwaukee Metropolitan Sewerage District
735 N Water St
Milwaukee WI 53202
414-225-2222

★ Mobay Corp
PO Box 4913
Kansas City MO 64120
816-242-2305

★ Monsanto
800 N Lindbergh Blvd
St Louis MO 63167
314-694-4310
800-225-2883

Moyer & Son
PO Box 198
Souderton PA 18964
800-345-0419

Moyer Products Inc
3321 W Castor St
Santa Ana CA 92704
714-549-2871

IN LANDSCAPING AND HORTICULTURE WHOEVER

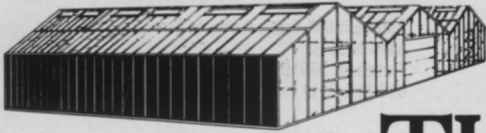

OWNS THE MOST MAKES THE MOST.

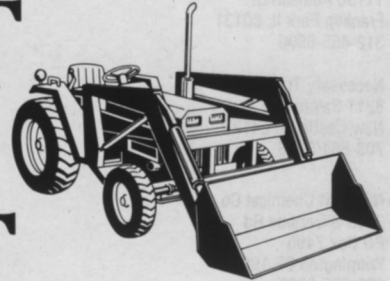

RIGHT?

WRONG.

Use, not ownership, creates profit.

You don't need to be an accountant to know that *owning* assets does not create profit . . . using them may.

In fact, your accountant might tell you that leasing may be the most cost-efficient financing source available today.

So if you're interested in a financing alternative that may provide you with tax advantages and that may improve your cash flow, consider these additional benefits of Agri-Lease® by Telmark®:

No down payment—Enjoy most of the advantages of

ownership without tying up your working capital in large, initial down payments.

100% tax deductibility—In most cases, Agri-Lease payments are fully tax-deductible busi-

ness operating expenses.

Bank/credit lines remain open—By using Agri-Lease to obtain what your business needs, you can keep your existing credit lines intact . . . and readily available.

If you want to know more about the financial benefits of Agri-Lease by Telmark . . . and how they may apply to *your* business . . . mail the coupon today.

I want to know more about the Flexible Financing AlternativeSM

Equipment

Buildings

Vehicles

Machinery

Name _____

Address _____

City _____ State _____ Zip _____

County _____ Phone _____

Mail to:

Telmark Inc.
P.O. Box 4943
Syracuse, NY 13221

315-449-7964

Note: Telmark leases are available throughout the Northeast, KY, MI, OH, VA and WV.
Minimum lease: \$5,000

Agri-Lease
BY TELMARK®

Chemical Companies

continued

Nacco Tyfo
14439 S Avalor
Gardena CA 90248
213-515-1700

Na-Churs Plant Food Co
421 Leader St
Marion OH 43302
614-382-5701

Nalco Chemical Co
One Nalco Center
Naperville IL 60566-1024
312-961-9500

Nature's Touch
Div Agro Chem Inc
11150 Addison St
Franklin Park IL 60131
312-455-6900

Necessary Trading Co
8211 Salem Ave
New Castle VA 24127
703-864-5103

★ NOR-AM Chemical Co
3509 Silverside Rd
PO Box 7495
Wilmington DE 19803
302-575-2000

North American Green Inc
14649 Hwy 41 N
Evansville IN 47711
812-867-6632

★ Par Ex
PO Box 512
Winter Haven FL 33882-0512
813-294-2567

Paygro Co
11000 Huntington Rd
South Charleston OH 45368
513-462-8358

PBI-Gordon Corp
1217 W 12 St
Kansas City MO 64101
816-421-4070

Plant Marvel Laboratories Inc
371 E 16 St
Chicago Heights IL 60411
312-757-7500

★ Precision Laboratories Inc
PO Box 127
Northbrook IL 60065
312-498-0800
800-323-6280

Prentiss Drug & Chemical Co
CB 2000
Floral Park NY 11001
516-326-1919

★ Pro Seed USA
PO Box 1250
San Marcos TX 78667
512-392-1900

PRS Materials Inc
882 Matlack St Unit E
West Chester PA 19382
215-430-3960

Reemay Inc
Industrial Rd
Old Hickory TN 37138
615-847-7000

★ Reinco Inc
520 North Ave
PO Box 512
Plainfield NJ 07060
800-526-7687

Reuter Laboratories Inc
8450 Natural Way
Manassas Park VA 22111
800-368-2244

R G B Laboratories Inc
1531 Charlotte St
Kansas City MO 64108
816-474-3342

Rhone Poulenc-Ag Co
2 T W Alexander Dr
Research Triangle Park NC 27709
919-549-2000

Rigo Co
Black Leaf Products Co
PO Box 189
Buckner KY 40010
502-222-1456

Ringer Corp
9959 Valley View Rd
Eden Prairie MN 55344
612-941-4180

Riverdale Chemical Co
425 W 194 St
Glenwood IL 60425-1584
312-754-3330

Roots Inc
25 Science Park
New Haven CT 06511
203-786-5295

Royalgard Products Co
100 Paces W. Ste 1240
2727 Paces Ferry Rd NW
Atlanta GA 30339
404-333-9067

Ruffin Inc
2201 E Wyatt Earp Blvd
PO Box 940
Dodge City KS 67801
316-225-0071

Safer Inc
189 Wells Ave
Newton MA 02159
617-964-2990

★ Sandoz Crop Protection
1300 E Touhy Ave
Des Plaines IL 60018
312-699-1616

★ O M Scott & Sons Co
14111 Scottslawn Rd
Marysville OH 43041
513-644-0011 (OH call collect)
800-543-0006

★ Sierra
1001 Yosemite Dr
Milpitas CA 95035
800-492-8255

D B Smith & Co
414 Main St
Utica NY 13501
315-735-5223

Soil Seal Corp
3015 Supply Ave
Los Angeles CA 90040
213-727-0654

Soil Technologies Corp
51 W Adams
PO Box 1415
Fairfield IA 52556
515-472-3969
800-221-7645

Southern Mill Creek Products Co
5414 N 56 St
Tampa FL 33610
813-626-2111

Southern Turf Nurseries
2200 Norcross Pkwy, Ste 255
Norcross GA 30071
404-448-9932

Spectrum Technologies Inc
12010 S Aero Dr
Plainfield IL 60544
800-248-8873

Sustane Corp
1107 Hazeltine Blvd
Chaska MN 55318
612-448-8828

Trebtor Corp
4045-A Jonesboro Rd
Forest Park GA 30050
404-366-0957

Triazone Corp
One Gatehall Dr
Parsippany NJ 07054
402-334-1804

UAP Special Products Inc
1035 E Dodge St
Fremont NE 68025
402-727-8689

Uniroyal Chemical
World Headquarters
Benson Rd
Middlebury CT 06749
203-573-3888

Valent USA Corp
1333 N California Blvd
Walnut Creek CA 94596
415-256-2700

Vigoro Industries Inc
PO Box 512
Winter Haven FL 33882-0512
813-294-2567

Warren's Turf Nursery Inc
Cordelia & Chadbourne Rds
PO Box 459
Suisun City CA 94585
707-422-5100

Weyerhaeuser
Engineered Fibers-EF4
Tacoma WA 98477
800-443-9179

★ Wilt-Pruf Product Inc
PO Box 469
Essex CT 06426
203-767-7033

Tomorrow is Today at TMI



SEED

Perennial Ryegrasses

- Aquarius
- Pennfine
- Allaire
- Manhattan II
- Rodeo
- Patriot
- Laredo
- Stallion
- V.I.P. Blends
- Spectrum Blends

Kentucky Bluegrasses

- Gnome
- Merit
- Tendos
- Twilight
- Rugby
- True Blue

Turf Type Tall Fescues

- Wrangler
- Aztec
- Taurus
- Sundance
- Turf Gem II
- Brookston

Dwarf Fescues

- Bonsai
- Turf Mates



Years of trials and research are necessary to develop new turf and forage varieties which keep pace with the ever changing needs of the consuming public.

That is why TMI is developing Today varieties that will carry us into the 1990's. From international sources and from some of the nation's finest universities, TMI is constantly searching for improvements to our proprietary program.

Circle No. 167 on Reader Inquiry Card



TMI's New Office/Research Facility EST. 1987



A Division of Stanford Seed

TURF MERCHANTS

33390 Tangent Loop Road • Tangent, OR 97389 • (503) 926-8649

FAX: 503-926-4435 • (Outside Oregon) (800) 421-1735





Ask your
Medalist® Turf
Distributor
about these
quality turf
products from
Northrup King:

Bluegrasses:

Adelphi
Aspen
Aquila
Kelly
Parade
Rugby
Trenton

Ryegrasses:

Caddle
Delray
Goalie
NK200
Pennfine

Fine Fescues:

Dawson
Ruby
Scaldis

Tall Fescues:

Arid
Galway

Others:

PennPals
Bentgrasses
Fults Alkaligrass

Mixtures & Blends:

Write or call for a
complete guide to
Northrup King's
line of pre-formu-
lated mixtures
and blends.



NO MATTER WHO WINS OR LOSES AT SOLDIER FIELD, WE GET TRAMPLED.

You've got to be tough to
win at Soldier Field.

A classic battle was fought
over this turf. When the
dust settled, Chicago picked
Medalist.

The lakefront home of
Chicago's rugged Bears is now
covered with a dense, beautiful premium
blend of Trenton, Rugby, Glade and Aspen
Kentucky Bluegrasses. All top-quality turf-
grasses from Northrup King.



It's a proven performer
that stands up to the re-
lentless pounding. Bounces
back strong week after week.
And resists the attacks
that can end the season
for less hearty performers.

Just being
pretty doesn't cut it in Chicago.
So tune in. You can now watch
the Bears stomp on one of the
nation's best.



Seed Companies

continued



5. Seed Companies

J & L Adikes Inc
182-12 93rd Ave
Jamaica NY 11423
718-739-4400

Kentucky Bluegrasses: Adelphi, Merit, S-21; Perennial Ryegrasses: All Star, Derby, Regal; Fescues: Creeping, Chewing, Hounddog Tall; Turfseed Mixes or Blends: made to specifications

Am-Sod Inc
2606 Hollister St
San Diego CA 92154
619-428-6112
Sod/Sprigs: Sod

Bamert Seed Co
Rte 3 Box 1120
Muleshoe TX 79347
806-272-5506
Other: Native grasses, Buffalograss

E F Burlingham & Sons
PO Box 217
Forest Grove OR 97116
503-357-2141
Fescues: (Tall) Falcon

Fine Lawn Research Inc
PO Box 290
Madison GA 30650
503-636-2600

Kentucky Bluegrasses: Chateau; Perennial Ryegrasses: Pennant; Fescues: Finelawn & Jaguar Turf Type Tall; Turfseed Mixes or Blends: Triple Play Perennial Rye Blend

Garfield Williamson Inc
Proform Turf Products Div
9 Stewart Pl
Fairfield NJ 07006
201-882-7755

Kentucky Bluegrasses: Liberty, Eclipse, Midnight, Classic, A-34, Adelphi, Challenger, Glade, Huntsville, Nassau, Ram I, Touchdown, Merit, JULIA; Perennial Ryegrasses: Omega II, Saturn, Pinnacle, Manhattan II, Citation II, Premier, Regal, Derby, Dasher II, Accord, Competitor; Fescues: (Tall) Jaguar, Jaguar II, Emperor, Apache, Bonanza, Tempo, Mustang, Arid, Falcon, (Creeping) Ensylna, Pennlawn, (Chewing) Shadow, (Hard) Spartan, Aurora; Bentgrasses: Pennlinks, Pennncross, Penneagle, Pennway, Seaside, Cobra; Turfseed Mixes or Blends: Proform Triple Classic Turf Rye Blend, Super Sport Turf, Deep Shade; Other: Turfseed Wildflower Mixture, Proform Native & Reclamation mixtures.

Great Western Seed Co
810 Jackson St
Albany OR 97321
503-928-3100

Kentucky Bluegrasses: Barblue, Baron, Georgetown, Majestic, Mystic, Nassau, Princeton (P104), Ram I, 1757; Perennial Ryegrasses: Cowboy, Diplomat, Palmer, Prelude, Repell, Yorktown II; Fescues: Clemfine Tall, Jamestown Chewings, Rebel Tall, Rebel II Tall, Reptans Creeper, Tribute Tall, Wilma Chewings; Bentgrasses: Astoria, Highland, Pennncross, Penneagle, Pennlinks; Turfseed Mixes or Blends: All of the above; Other: Agree Intermediate Ryegrass

Jonathan Green & Sons Inc
Squankum-Yellowbrook Rd
PO Box 326
Farmingdale NJ 07727
201-938-7007

Kentucky Bluegrasses: Destiny, Gnome, Adelphi, America, A-34, Banff, Chateau, Classic, Eclipse, Enmundi, Fylking, Glade, Harmony, Huntsville, KenBlue, Sabre, Nassau, Merit, Ram I, Monopoly, Touchdown Washington Perennial Ryegrasses: Allaire, Allstar, Dasher, Fiesta, Manhattan II, Linn, Premier, Sherwood, Gettysburg Fescues: (Tall) Arid, Bonanza, Finelawn I, Kentucky-31, Mesa, Mustang, Richmond, Tempo, Montauk, Potamac (Chewing) Jamestown, Victory, Pennlawn Red, Azay Sheeps, Spartan Hard, Bentgrasses: Exeter, Kingston, Pennncross, Penneagle, Pennstar, Pennway, Pennlinks, Seaside Turfseed Mixes or Blends: Touch-up Ryegrass Blend, Showlawn, Blue-Rye, Sodmaker, Full Sun, Dense Shade, Sun & Shade, Drought Tough, Fun Lawn, Heavy Traffic, Fast Grow, Contractors Mix, Veri-Green Other: Birdsfoot Trefoil, Switchgrass, Clovers, Crown Vetch, Deertongue, Orchardgrass, Redtop, Reed Canarygrass, Lस्पेдеза, Timothy, Weeping Lovegrass, Winter Rye, Wildflower mixtures and straight varieties

International Seeds Inc
820 First St
PO Box 168
Halsey OR 97348
503-369-2251

Kentucky Bluegrasses: Ikone, Ampellia Perennial Ryegrasses: Gator, Troubadour, Elka, Derby, Lindsay, Regal Fescues: Pacer, Cindy, Valda Enjoy & Longfellow, Ensylna, Gala, Hounddog Bentgrass: Cobra, Emerald Turfseed Mixes or Blends: Dixie Green, Overseeding mixture, PH D Custom overseeding Blend Other: Sabre, Poa Trivialis Fesa, Strawberry clover

* Jacklin Seed Co
W 5300 Riverbend Ave
Post Falls ID 83854
208-773-7581

Kentucky Bluegrasses: Glade, Fylking, Wabash, Eclipse, Nassau, Nugget, Ram I, Huntsville, Merion, Amazon, Adelphi, Freedom, Suffolk, Cheri Perennial Ryegrasses: All*Star Fescues: Arid & Wrangler Turf-Type Tall, Fate Tall; Bentgrasses: Putter Creeping; Other: Reubens Canada Bluegrass, MX-86 Sheep Fescue

* LESCO Inc
20005 Lake Rd
Rocky River OH 44116
216-333-9250

Kentucky Bluegrasses: Adelphi, A-34, Challenger, Columbia, Dawn, Eclipse, Fylking, Glade, Common Kentucky, Merit, Midnight, Park; Perennial Ryegrasses: Birdie II, Citation II, Derby, Linn, Manhattan II, Omega II, Pennfine, Regal, Regency, Vintage 2DF, Commander, Assure; Fescues: (Chewing) Shadow; (Creeping) Flyer, Shademaster, Pennlawn; (Hard) Aurora; (Tall) Apache, Bonanza, Cimarron, Kentucky 31, Olympic; Bentgrasses: Colonial-Astoria, Highland; Creeping-Pennncross, Penneagle, Pennway Blend, Seaside, Pennlinks; Turf Seed Mixes or Blends: LESCO: Classic Sunny Turf, Quality Blue, Double Eagle-CBS II, Eagle, Premium, Park & Athletic Mix, Shade Mix, Transition, Turf-Turf, 3CN Intermediate Ryegrass, Touch-Up, Double Eagle, Eagle Blend I, Vintage Plus, Par Blend, Transtar Blend, Pennway Bent Blend, Bent Blend Plus

Lofts Seed Inc
Chimney Rock Rd
PO Box 146
Bound Brook NJ 08805
201-356-8700

Kentucky Bluegrasses: Baron, Nassau, Ram I, Georgetown, Princeton (P-104), 1757 Mystic, Suffolk; Perennial Ryegrasses: Palmer, Prelude, Cowboy, Yorktown II, Repell, Diplomat; Fescues: Jamestown Chewings, Rebel, Reliant Hard, Rebell II, Tribute Tall, Clemfine Tall Bentgrasses: Southshore Creeping Turfseed Mixes or Blends: Tri-plex Ryegrass-(Palmer,

Prelude, Cowboy) Summer Stress (90% Rebel II Tall, 10% Nassau Kentucky Bluegrass; Other: Laser Poa trivialis & Pinto Wildflower Mixtures

* Northrup King
Medalist Turf Products Div
7500 Olson Memorial Hwy
Minneapolis MN 55427
612-593-7333



Kentucky Bluegrasses: Adelphi, Aspen, Aquila, Parade, Rugby, Trenton; Perennial Ryegrasses: Caddie, Delray, Goalie, NK200, Pennfine; Fescues: Arid tall, Dawson red, Ruby creeping red, Scaldis hard, Galway tall, Cameo chewings, Amigo tall; Bentgrasses: Highland, Pennncross, Penneagle, Seaside; Turfseed Mixes or Blends: Athletic Pro, Athletic Pro II, Overseeder II, Overseeder III, Renovator Pro, Special Park, Premier Turf, Swift & Sure, Premium Sod, Shady Turf, Medalist North, Landscape Pro, Boulevard Mix, Super Pro III, General Turf, Landscape Pro West, Alkali Turf Mix, Triple Pro Blend, Medalist 7, Medalist 6, Medalist 5, Medalist 7 + Sabre, Medalist 400, Medalist 400 + Sabre, Medalist 60/40, Landscape Pro Mix III, Shady Turf III, Premier Turf Mix III, Premium Sod Blend III, Winchester Mix; Other: Fults Puccinellia distans

Oregon Fine Fescue Commission
866 Lancaster Dr SE
Salem OR 97301
503-585-1157
Fescue: creeping and chewings red

Oregon Ryegrass Growers Seed Commission
4093 12th St SE
PO Box 3366
Salem OR 97302
503-364-3346
Perennial Ryegrasses: all Oregon Ryegrasses;

* Oregon Tall Fescue Commission
866 Lancaster Dr SE
Salem OR 97301
503-585-1157

OSECO Inc
210 Wanless Dr
Brampton ON Canada
L6V 2L2
416-846-5080

Kentucky Bluegrasses: Baron, Gnome, Haga, Majestic, Midnight, Nassau, Sydsport Reubens Canada; Perennial Ryegrasses: Barry, Yorktown I, Palmer, Gator; Fescues: Biljart hard, Fortress creeping red, Highlight, Keket & Wilma chewings, Rebel & Rebel II tall; Bentgrasses: Emerald, Pennncross, Penneagle; Turfseed Mixes or Blends: Custom mixed from aforementioned species

Pennfine Perennial Ryegrass
PO Box 959
Minneapolis MN 55440
612-593-7333
Perennial Ryegrasses: Pennfine

Pennington Enterprises Inc
PO Box 290
Madison GA 30650
404-342-1234
800-768-5400

Kentucky Bluegrasses: Chateau, Huntsville Perennial Ryegrasses: Sunrise 246, Pebble Beach, Stallion Fescues: Tall; Fine Lawn I, Fine Lawn 5GL, Wrangler Red; Flyer, Hard; Aurora Seeded Bermudagrass; Cheyenne Turfseed Mixes or Blends: Sunrise Primo Perennial Ryegrass, Triple Play Perennial Rye Blend, Sunrise Southern Greens, Triad Turf Type Tall Fescue, Triad Blue, Pennington Green

Seed Companies

continued

Peterson Seed Co
PO Box 346
Savage MN 55378
612-445-2606

Kentucky Bluegrasses: Monopoly, Classic & Eclipse

Otto Pick & Sons Seeds Ltd
11151 Yonge St
Box 126
Richmond Hill ON Canada
L4C 4X9
416-884-1147
Fax 416-884-1538

Kentucky Bluegrasses: America, A34, Banff, Cheri, Nugget, Fyking Perennial Ryegrasses: Blazer, Blazer II, Fiesta, Fiesta II, Jazz Fescues: (Chewings) Agram, Jamestown, Victory; (Creeping) Boreal, Pennlawn (Hard Fescue) Spartan (Tall) Mustand, KY31; Bentgrasses: Colonial, Creeping, National, Penncross, Penneagle

★ Pickseed West Inc

PO Box 888
Tangent OR 97389
503-926-8886

Kentucky Bluegrasses: Alpine, America, Touchdown, Banff, Bronco; Perennial Ryegrasses: Fiesta II, Blazer II, Dasher II, Jazz, LEX 86, Pick 715; Fescues: (Tall) Mustang, Maverick II, Thoroughbred, Shortstop; (Tall) Crossfire; (Chewings) Agram, Victory; (Hard) Spartan, Tournament; (Sheep) Azay; (Creeping) Jasper; Bentgrasses: Exeter colonial, Kingstown velvet, National creeping, Penncross, Penneagle, Pennlinks creeping; Turfseed Mixes or Blends: Futura 2000, Fiesta II, Dasher II, Blazer II, Futura Plus (Fiesta, Dasher, Blazer), Team (Mustang, Maverick II, Thoroughbred); Other: Colt poa trivialis, Flowers 'n' Flowers wild flower mix, Flowers 'n' Grass mix

Proprietary Seeds Inc
2882 Howell Prairie Rd NE
Salem OR 97305
503-585-7033

Kentucky Bluegrasses: Merit, Showplace Brand Blend; Perennial Ryegrasses: Vantage, Magnum Brand Blend; Fescues: Bonanza Tall; Turfseed Mixes or Blends: Magnum brand perennial ryegrass blend (Vantage, Citation II, Caliente, Prelude, Palmer)

PROPRIETARY
S E E D S

INCORPORATED

WE'RE GROWING THE TURFGRASSES YOU NEED!

- **Bonanza Tall Fescue**
- **Vantage Perennial Ryegrass**
- **Magnum Brand Perennial Ryegrass Blend**

Many other public and private variety turfgrasses available including:

Penncross Bentgrass
Penneagle Bentgrass
Shadow Chewings Fescue
Merit Kentucky Bluegrass
Citation II Perennial Ryegrass
Caliente Perennial Ryegrass

WATCH FOR OUR NEW DWARF TALL FESCUE COMING IN 1990!

Proprietary Seeds, Inc.
2882 Howell Prairie Rd NE
Salem, Oregon 97305

1-800-228-4119 FAX: 1-503-585-3273

Roberts Seeds
PO Box 206

Tangent OR 97389
503-926-8891 Kentucky Bluegrasses: estate Perennial Ryegrasses: Calypso, Riviera Fescues: Chiefton, Guardian Turfseed: Mix to companies specifications

★ O M Scott & Sons Co

14111 Scottslawn Rd
Marysville OH 43041
513-644-0011 (OH call collect)
800-543-0006

Kentucky Bluegrasses: Victa, Bristol, Abbey, Coventry; Perennial Ryegrasses: Loretta Ovation, Caravelle; Fescues: Banner Bentgrasses: Penncross, Penneagle, Pennlinks, Penway; Turfseed Mixes or Blends: Sportsturf (Loretta/Pennant Perennial Ryegrass, Abbey/Victa Bluegrass); Other Turf Seed: Winter Turf overseeding line (4 different Perennial Ryegrass blends)

Seaboard Seed Co

PO Box 117
Bristol IL 60512
312-553-5800

Kentucky Bluegrasses: Midnight, Classic, Eclipse, Glad, Haga, Adelphi, Baron, Merit, Gnome, Monopoly, Parade, Touchdown, Nassau, Banff, Newport, Julia, Chateau, America, A-34, Park, Rami, Nugget; Perennial Ryegrasses: Palmer, Prelude, Manhattan II, Pennant, Derby, Fiesta II, Pennfine, Manhattan II, Citation, Jazz, Rodeo, Patriot, Omega II; Fescues: Fine-spartan, Saldis, Victory, Jamestown, Koket, Pennlawn, Tall-arid, Olympic, Apache, Adventure, Mustang, Falcon, Brookston, K 31; Bentgrasses: Penncross, Penneagle, Seaside, Highland, Exeter, Red top; Turfseed Mixes or Blends: Custom mixes; Other: Crown Vetch, Birdsfoot Trefoil, Native Grasses, Wildflowers, Poa Trivialis, Canada bluegrass, Fults, Reed Canary

Seed Research of Oregon Inc

PO Box 1416
Corvallis OR 97339
503-757-2663

Kentucky Bluegrasses: Harmony Perennial Ryegrasses: SR4000, SR4100, Champion Fescues: (Tall) Titan, Trident, Hard-SR3000, Chewings-SR5000, Creeping red; Bentgrasses: SR1020, Providence, Prominent; Turfseed Mixes or Blends: Champion SR 4000 & SR4100, Trophy, Survivor, Titan, Trident, Bonanza, Dominant, Providence

Southern Turf Nurseries

2200 Norcross Pkwy Ste 255
Norcross GA 30071
404-448-9932
Sod/Sprigs (South Only): Tifway 419, Tifgreen 328, Tifwarf, Centipede, Midiron

Sunbelt Seeds Inc

2200 Norcross Pkwy Ste 255
Norcross GA 30071
404-448-9932
Kentucky Bluegrasses: Baron, Nassau, Georgetown, Ram I, Mystic, Suffolk; Perennial Ryegrasses: Palmer, Prelude, Cowboy, Yorktown II, Repell; Fescues: Jamestown Chewings; (Tall) Rebel, Rebel II, Tribute, Clemfene, Barnone; (Creeping) Southshore; Turfseed Mixes or Blends: Marvel Green Supreme, Marvelgreen Classic, Marvelgreen & Laser, Marvelgreen 3 +1, Marvelgreen Transition, Marvelgreen Sports Mix; Other: Pinto Wildflowers, Centipede, Hulled Bermuda, Weeping Lovegrass, Carpetgrass

★ Tee-2-Green Corp

3017 G St
PO Box 250
Hubbard OR 97032
503-981-9574
800-247-6910
Bentgrasses: Penncross, Penneagle, Pennlinks, Penway blend

Turf Merchants Inc (TMI)

PO Box 1467
Albany OR 97321
503-491-3622
800-421-1735

Kentucky Bluegrasses: Gnome, Tendos, True Blue, Lexington, Rugby; Perennial Ryegrasses: Pennfine, Manhattan II, Rodeo, Patriot; Fescues: Tall-Wrangler, Turfgem, Brookston; Bentgrasses: VIP Cr. Blend; Turfseed Mixes or Blends: VIP Overseeding Blend (Pennfine, Manhattan II, Patriot)

★ Turf Merchants International (TMI)

33390 Tangent Loop
Tangent OR 97389
503-926-8649
800-421-1735
Fax 503-926-4435

Kentucky Bluegrasses: Gnome, Tendos, True Blue, Merit, Rugby Perennial Ryegrasses: Aquarius, Patriot, VIP, Pennfine, Manhattan II, Rodeo, Stallion; Fescues: (Tall) Wrangler, Taurus, Aztec, Turf Gem II; Bentgrasses: Penncross, Penneagle, Pennlinks

★ Turf Seed Inc

3017 G St
PO Box 250
Hubbard OR 97032
503-981-9571
800-247-6910

Kentucky Bluegrasses: Midnight, Columbia, Challenger, Voyager, Galaxy Blend, Blacksburg Perennial Ryegrasses: Manhattan II, Citation II, Birdie II, 246, Charger, Omega II, Remington, Saturn, Alliance Blend, CBS II Blend Fescues: (Tall) Apache, Olympic, El Dorado, Triathalawn, Silverado, Monarch, Murietta Shadow Chewings, Aurora Hard, Fortress creeping, Shadmaster creeping, Big Horn Sheeps, Flyer Bentgrasses: Pencross, Penneagle, Pennlinks, Penway

Van Der Have Oregon Inc

PO Box 1496
Albany OR 97321
503-967-8923

Kentucky Bluegrasses: Sophia, Minstral, Cynthia; Perennial Ryegrasses: Ranger, Brenda, Nova, Mondial, 2H7; Fescues: (Chewings) Waldorf, Epsom (Creeping) Dawson; (Tall) HRZ-18, Biljart, Silvana Hard; Bentgrasses: (Creeping) Carmen (Colonial) Tracenta Turfseed Mixes or Blends: Quartet-Mondial, Brenda, Patriot, Pennfine

Vaughan Seed Co

5300 Katrine Ave
Downers Grove IL 60515
312-969-6300
Kentucky Bluegrasses: Adelphi; Perennial Ryegrasses: All Star, Citation

Vaughan Seed Co

Chimney Rock Rd
Bound Brook NJ 08805
201-356-4200
Kentucky Bluegrasses: Adelphi, Glade, Cheri, Merit, Touchdown; Perennial Ryegrasses: All Star, Pennant, Citation, Regal

Warren's Turf Nursery Inc

Cordelia & Chadbourne Rds
PO Box 459
Suisun City CA 94585
707-422-5100
Kentucky Bluegrasses: Warren's A-34, Able-1 Fescues: Adventure Turf Type Tall, Avanti Tall

Willamette Seed

PO Box 791
Albany OR 97321
503-926-2728
Perennial Ryegrasses: Ranger, Seville, Caliente; Fescues: Willamette, Shannandoha & PIP Turf Type Tall; Turfseed Mixes or Blends: Southern Select & Club

Why The Grass Is Always Greener At ServiceMaster.

Last year, revenues for the lawn care industry as a whole grew 15%.

Revenues for ServiceMaster LawnCare grew a whopping 77%! Over five times the industry rate.

Obviously, we must be doing something right. And we are.

For one thing, ServiceMaster is one of the few lawn care companies able to provide truly *customized* treatment to every customer.



Customized treatment.

We specially design our own trucks and equipment so you can individually tailor your treatment to each lawn.

For another, we provide complete training and back-up support. Programs like discount purchasing. A 1-800 hot line for special agronomic

questions. Year-round marketing support that will help you get business even in winter.

Over 90% of our ServiceMaster franchises are still going strong after three years. This year, in fact, *Fortune* magazine named us No. 1

Partners in the ServiceMaster Quality Service Network.

ServiceMASTER. TERMINIX. merry maids.



Revenues for ServiceMaster LawnCare grew over five times the industry rate.

for return on equity in their ratings of the 500 top service companies in America.

So if you're looking for the right opportunity to start your own lawn care business, you simply can't find a company with a more consistent record for success.

If you qualify, you could get started in a ServiceMaster LawnCare franchise for as little as \$7,000 plus additional working capital.

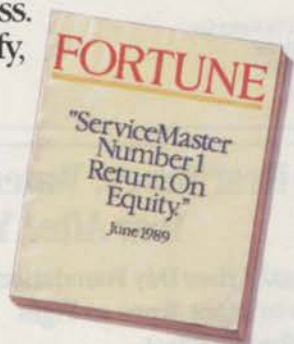

You can start out while still keeping your regular job if you wish.

For more information, call Stan Guy toll-free at 1-800-635-SERVE.



ServiceMaster.
LawnCare

Seed Companies

continued

Choice blend of Ranger, Seville & Caliente; Plantation Pride tall blend of turf type fescues; Other: Bloomcoat wildflower seeds

Zajac Performance Seeds
33 Sicomac Rd
North Haledon NJ 07508
201-423-1660

Kentucky Bluegrasses: Eclipse, Liberty; Perennial Ryegrasses: Omega II, Envy, Saturn; Fescues: (Tall) Jaguar II, Emperor, (Creeping) Vista Turfseed Mixes or Blends: Custom blends

6. Miscellaneous Services

Agri-Diagnostics Assocs
2611 Branch Pike
Cinnaminson NJ 08077
609-829-0110
Diagnostic services

★ Air-O-Lator
8100-04 Paseo
Kansas City MO 64131
816-363-4242(MO)
800-821-3177
Fountains

Akzo Industrial Systems Co
One North Pack Sq
Asheville NC 28802
704-258-5050

Subsurface drainage matting, natural turf and soil reinforcement matting

C D Anderson
515 Ogden Ave
Downers Grove IL 60515
312-964-0399
Landscape training videos

Bush and Cook Leasing Inc
1600 W Main St
Wilmington OH 45177
513-382-5502(OH)
800-342-4784
Equipment leasing/financing

Colorado Aggregate
2255 Lava Lane
Alamosa CO 81101
719-589-4925(CO)
800-528-2765
Decorative rocks (landscape supplies)

Environmental Industries Inc
24121 Ventura Blvd
Calabasas CA 91302
818-992-5900
Landscape services

G E Mobile Communications
Mountain View Rd
Lynchburg VA 24502
800-GE1-2345
Mobile radios

Morie Co
1201 N High St
Millville NJ 08332
800-257-7034
609-327-4500
Sands, clays and specialty mixes

Opti-Gro Div Mantek
PO Box 2170
Irving TX 75061
800-241-3302
404-952-0228(GA)
Grounds care technology

★ Plastic Safety Systems
PO Box 20140
Cleveland OH 44120
216-231-8590
800-662-6338
Plastic fencing

★ ServiceMaster LawnCare
2300 Warrenville Rd
Downers Grove IL 60515
312-964-1300
Lawn care franchises

★ Telmark Inc
Box 4943
Syracuse NY 13221
Agri-lease

Velotta Uniform Sales Inc
12429 Cedar Rd
Cleveland OH 44106
216-791-5050
800-544-2737, Hear Tone, Dial 38
Work uniforms, caps, jackets, monogramming, computerized logo embroidery

Savage Heat Waves, Water Shortages, Parched Farms Year After Year After Year

The National Arbor Day Foundation Urges You to Plant Trees to Fight the Greenhouse Effect

The Earth is heating up. "The Greenhouse Effect," says James E. Hansen, Director of NASA's Institute for Space Studies, "is here... it's time to stop waffling."

A sharp increase in atmospheric carbon dioxide (CO₂) is a major cause. Two things contribute — the burning of fossil fuels and the destruction of forests.

You can make a difference. Trees you plant may be our best line of defense. Trees can shade your home in summer, and slow winter wind. While your trees absorb CO₂, they also reduce the amount of fossil fuel burned for cooling and heating.

As a result, your trees can be as effective as 15 forest trees in fighting the Greenhouse Effect.

Free Booklet. The National Arbor Day Foundation has published a guidebook titled *Conservation Trees* which will show you how to plant and prune shade trees and windbreaks.

I'm pleased to offer it to you free of



charge. Just return the coupon below and I'll send your *Conservation Trees* booklet by return mail.

John Rosenow

John Rosenow, Executive Director
National Arbor Day Foundation

Yes, Send my free
Conservation Trees booklet.

Name _____

Address _____

City _____ State _____ Zip _____

Mail to: Conservation Trees, National Arbor Day
Foundation, Nebraska City, NE 68410

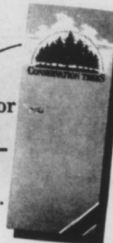

WHAT HAPPENS TO YOUR REPUTATION WHEN YOU SPECIFY MULCH?

Specifying bark or mulch as a ground cover might seem like a bright idea at first. But soon as the cover starts to decay and deteriorate, the brilliance of your original design begins to fade. That's why you should insist on FloweRock®, a natural volcanic stone that retains moisture, insulates the soil and enhances weed control while fully maintaining its beautiful earth tones. Find out how FloweRock can help your reputation for quality endure. Contact your nearest distributor, or call Colorado Aggregate at 1-800-528-2765 or 1-719-589-4925 (in Colorado).

FLOWEROCK®
Permanent Ground Cover

Measuring device is accurate to the inch

Stanley Tools now offers a measuring wheel to measure distances quickly and accurately. The wheel (Model 39-012) uses a precision-calibrated, push-button resettable counter that automatically records measurements in feet and inches, up to 1,000 feet.

The unit features a wide, one-foot circumference wheel rimmed with a Neoprene tire. It also comes with a telescoping handle, from 22 to 36 inches.



Circle No. 201 on Reader Inquiry Card

Splice kits ideal for irrigation work

Direct Bury Splice Kits with Scotchlok R connectors permit fast, simple installation of underground electrical splices for use in projects of 30 volts or less.

The kit, from 3M's Electrical Prod-

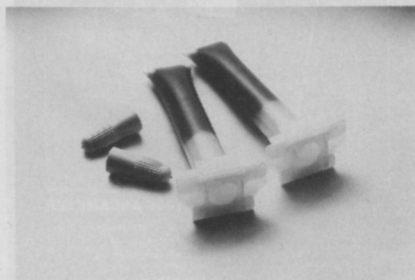

ucts Division, requires no crimping tool or other equipment to make quick, reliable splices. The procedure involves stripping wires, twisting on a Scotchlok connector, then inserting

the connector into a tube that has been pre-filled with insulating gel. The tube cover is snapped shut and the entire assembly is buried. Locking fingers in the tube hold the Scotchlok connector in place and the closed tube cover provides strain relief. The pre-filled tube eliminates the problem of installers using too much or too little gel.

The splices are designed to protect against corrosion failure. Effective application range is 32 to 120°F.

Circle No. 202 on Reader Inquiry Card

Aerating cores eliminated by pulverizing action

The Lawn Genie is a pick-up sweeper/mower from Mathews Company that eliminates aerating cores with one pass down the fairway.

When a damper is in the open position, the hammer action of the Genie's free-swinging flail knives pulverizes the cores and returns most of the soil to the ground. Vacuum paddles create a vacuum to pick up thatch and grass. The damper can also be closed to deposit the pulverized cores over ground.

Mathews says tractor-powered Genies in 60-inch and 72-inch widths with Category 1, 3-point hitches and 540 rpm PTO are being used to remove cores on golf courses and other fine turf areas in parks and on playing fields. They are also used to pick up leaves, twigs and other debris.



A driver controlled cable winch is used to empty the hopper. A hydraulic dump kit is also available.

Circle No. 203 on Reader Inquiry Card

Brochure details features of new tractor series

The new Jaguar 4000 series tractor is featured in a brochure from Ransomes.

Information is provided on the four-mower line, along with detailed specification data.

The Jaguar 4000 is a premium machine incorporating the best in rotary

mowing technology, Ransomes claims. Mowing decks of either 61" or 74" are available. The 74" deck has a deepdraft design to insure that all clippings are discharged out the chute, minimizing clumps.

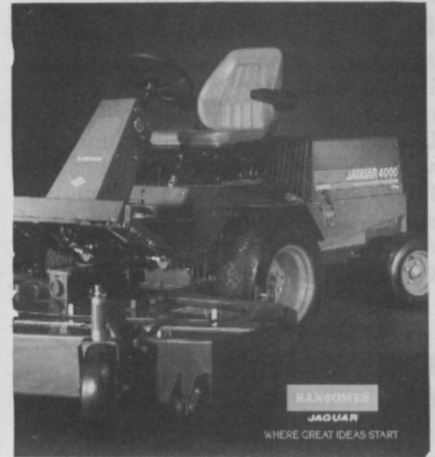

Single-pedal hydrostatic control is standard, and controls all forward and reverse movement. A patent pending automatic differential lock is available on two models and reduces wheel slippage and turf damage.

Circle No. 204 on Reader Inquiry Card

Irrigation hose works in tight quarters

The Super Blue Flex Hose is the newest product from Hardie Irrigation. Hardie says the hose is extremely flexible, easy to work with and ideal for installing sprinklers in tight quarters. The Super Blue Flex Hose is compatible with all fittings, including

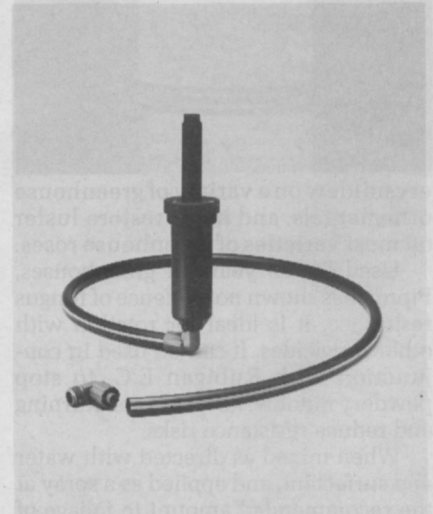

Olson E-Z, ELL, Dura, Toro and Rain Bird.

Each coil is wrapped in lengths of 100 feet, and unwinds easily from the center of the coil.

continued on page 104

The Super Blue is made of very low density polyethylene, and has 80 psi maximum working pressure at 100°F. **Circle No. 205 on Reader Inquiry Card**

Sweeper-mower new for core clean-up

Mathews Company of Crystal Lake, Ill. has published an illustrated brochure describing the use of the M-C Lawn Genie in sweeping up and pulverizing aerating cores on golf course fairways. How this sweeper-mower solves the problem of getting rid of cores is shown in photos and text. **Circle No. 213 on Reader Inquiry Card**

New fungicide formula called more versatile

A new formulation of Elanco's Pipron is now available, with a label upgrade from "danger" to "warning." The new Pipron does not have any re-entry restrictions in states in which those laws apply.

Elanco says Pipron controls powd-



ery mildew on a variety of greenhouse ornamentals, and helps restore luster on most varieties of greenhouse roses.

Used for 20 years in greenhouses, Pipron has shown no evidence of fungus resistance. It is ideal for rotation with other fungicides. It can be used in conjunction with Rubigan E.C. to stop powdery mildew, keep it from returning and reduce resistance risks.

When mixed as directed with water and surfactant, and applied as a spray at the recommended amount to foliage of ornamental plants, Pipron is effective against powdery mildew on rose, lilac, dahlia, phlox, zinnia, chrysanthemum and catalpa. Spray after leaves expand or at symptoms of powdery mildew.

Circle No. 206 on Reader Inquiry Card

Residue detector gives results in minutes

A new method for measuring insecticide residue can detect 80 percent of all U.S. registered insecticides, according to Enzytec, Inc.

The product is the size and shape

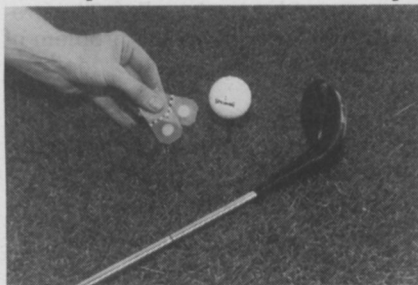

of a small ticket, and can detect the presence or absence of the carbamate, thiophosphate and organophosphate insecticides. Detection range is up to 1 to 10 parts per billion. The ticket detects pesticides in air, water, soil or on surfaces, depending on the technique used.

According to Elizabeth Burkett, marketing manager for EnzyTec, the detection system can be used in a number of ways by golf and grounds maintenance professionals. For example, workers can efficiently monitor the need to change filters in respirators. "Placed inside the facemask, away from the nose and mouth, the detector disc allows an applicator to check the effectiveness of his respirator filter and lets him know when to change it," says Burkett. "A white result on the detector ticket indicates the need for a filter change, while a blue result indicates an effective filter."

EnzyTec says the test can also provide superintendents with a method of monitoring golfer exposure to insecticides applied to a golf course over the golfing season.

They are available in kits of 10, 25, 50 or 100 tickets.

Circle No. 207 on Reader Inquiry Card

Plant materials on screen with new visual database

Landcadd, Inc. announces a visual database of plant materials for use with its Site Planning and Landscape Design module. Landcadd users will be able to select a menu item labeled "show photo," to view an actual photographic image of the specific plant.

"Being able to show a client exactly what a particular plant will look like, while viewing a computerized construction drawing, is very advantageous," says Greg Jameson, president of Landcadd. "As video imaging is becoming increasingly popular,

Landcadd is providing a viable solution for linking CAD drawings to actual photographs."

The visual database of plant materials is being developed with the idea that it may eventually be used in conjunction with Landcadd and AutoCad to develop realistic "video imaging" views of a site. Links will also be provided to the text-based plant database currently offered with Landcadd.

Circle No. 208 on Reader Inquiry Card

Save water and energy with flow-regulated unit

Netafim Irrigation's Dan 2001 Micro-Sprinkler is flow regulated for all terrain with high uniformity and protection from sand and insects.

According to Netafim, the Dan 2001 is ideal for application in orchards, vineyards, greenhouses and nurseries and for micro-climate control. It easily retrofits many existing irrigation systems, and the large nozzle diameters and self-cleaning design reduce chances of clogging.

The sprinkler has low precipitation rates for effective soil penetration. Its interchangeable orifices require no tools for disassembly. The Dan 2001 is fully flow compensating over a pressure range of 20-50 psi, assuring balanced water distribution.

Circle No. 214 on Reader Inquiry Card

Areometer records speed, time and distance traveled

The AMC 100 Areometer system is now available from Warner Electric/Dana Corporation. The Areometer can be mounted on a variety of vehi-

WARNER

Take the guess work out of Area Measurement...

...AMC1000 AREAMETER

- Accurate measurement of Area
- Easily programmed
- Records only when the implement is in use
- Data retained - even when disconnected
- Kit Form, complete with sensors and cable - ready for installation

WARNER ELECTRIC

cles to measure, monitor and record the area traversed by the vehicle, as well as the speed, time and distance.

Applications for the Areometer in-

clude measurement of farm land for precision application of seed and fertilizer, measurement of open areas to determine the amount of material required for paving, and maintenance requirements for large landscaped areas such as golf courses.

The first time the system is used, it measures and records the work area to establish a baseline of information for subsequent operations.

Circle No. 209 on Reader Inquiry Card

New mower line features three adjustable models

A new line of commercial grade walk-behind mowers is now available from Woods. Mowing widths are 36, 48 and 61 inches, with adjustable cutting heights from 1½ to 4 inches.

A heavy duty hydrostatic transaxle



drive provides smooth operation, fast response and eliminates clutching. One lever controls speed, from 0 to 6 mph and up to 2 mph in reverse. Dual disc brakes are employed for precision steering.

Traction is improved with 16-inch tires. An oil bath gear drive is used to drive both wheels to assure straight tracking.

The mower deck on these units is welded from 10-gauge steel, with double reinforced side skirts.

Kohler provides the power.

Circle No. 210 on Reader Inquiry Card

Hand pump designed as bacteria fighter

A new prototype of the Renson hand pump that is protected from contamination has been developed by F.R. Industries of Pittsburgh and French manufacturer Renson.

continued on page 106

GREAT ON THE GREAT OUTDOORS.

GREENSKEEPER 20-4-10

Circle No. 138
on Reader
Inquiry Card

The great outdoors has a wide range of turf conditions. So where do you turn for one superior, yet economical feeding? Greenskeeper 20-4-10. This homogeneous fertilizer contains 40% organic nitrogen and is formulated for immediate turf green-up and sustained feeding. Yet it is cost-efficient for use on a diversity of turf areas. From your source for premium quality turf products.

Lebanon
TOTAL TURF CARE
A division of Lebanon Chemical Corporation

Choose The RIGHT PLASTIC FENCE



IDEAL FOR GOLF TOURNAMENTS
and special events; construction,
maintenance, landscaping and newly
seeded areas; snow and sand control.

- Variety of styles, colors, heights,
lengths and weights.
- Low cost per lineal foot.
- Easy to install, take down and store.
- Washes clean for repeated use.

PLASTIC SAFETY
SYSTEMS, INC.



EXPRESS

GUARANTEED SHIPMENT WITHIN 48 HOURS
... OR WE PAY THE FREIGHT!

CALL TOLL FREE **1-800-662-6338**
P.O. Box 20140 Cleveland, Ohio 44120
Phone 216/231-8590 • Fax 216/231-2702

Circle No. 155 on Reader Inquiry Card

PRODUCTS from page 105

The opening around the shaft has been effectively sealed and an O-ring has been installed inside the shaft opening.

F.R. Industries says the pump improves the quality of drinking water and reduces the cost of maintenance.

In November 1988, according to F.R. Industries, the Delaware Bureau of Environmental Health stated that the Renson pump had met the sani-



tary design requirements necessary to ensure public health.

Circle No. 211 on Reader Inquiry Card

Keep debris in place with sweeper apron

Parker Sweeper Company's Sweep-A-Lawn lawn sweeper keeps grass and leaves in place and safe from swirling winds.

Elastic cords are anchored through grommets at both upper corners of the wind apron and are secured to the upper basket rod with hooks on each

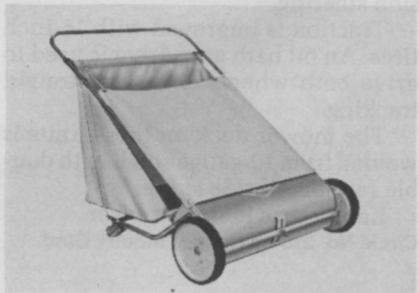

side. The wind apron fits snugly and is easily removed for emptying.

Parker says the Sweep-A-Lawn can be used as either a push or trailing sweeper. Hitch for the trailing sweeper is optional. Sweeping width is 30 feet and the basket holds 4.4 cubic feet of material.

Circle No. 212 on Reader Inquiry Card

CLASSIFIEDS

RATES: \$1.20 per word (minimum charge, \$35). Bold face words or words in all capital letters charged at \$1.45 per word. Boxed or display ads: \$100 per column inch-1x (one inch minimum); \$95-3x; \$90-6x; \$85-9x; \$80-12x. (Frequencies based on a calendar year). Agency commissions will be given only when camera-ready art is provided by agency. For ads using blind box number, add \$15 to total cost of ad. Send ad copy with payment to Dawn Nilsen, LANDSCAPE MANAGEMENT, 1 East First Street, Duluth, MN 55802 or call 218-723-9505. Fax Number 218-723-9515.

BOX NUMBER REPLIES: Mail box number replies to: LANDSCAPE MANAGEMENT, Classified Ad Department, 1 East First St., Duluth, MN 55802. Please include box number in address.

BUSINESS OPPORTUNITIES

In Mid-Western Wisconsin: Well established landscaping business averaging 110K per year, located in rapidly growing city, 45 miles East of Mpls., St. Paul. Includes all landscaping equipment, vehicles, nursery stock, snowplowing business, etc. Also includes 5 bedroom home on 3 acres with buildings, spa, swimming pool, fireplace. **Great Opportunity.** \$179,000. 715-235-7307. 9/89

CURB MATE - THE MONEY MACHINE: Patented, electrically driven and self-propelled machine produces beautiful continuous concrete landscape edging. Simplifies the installation of concrete borders between lawns and flower beds, along driveways and sidewalks, etc. Applications for residential and commercial settings, golf courses, etc. Turn \$5,000-\$10,000 equipment purchase into \$50,000-\$100,000 potential annual income. (801)273-3938. 9/89

WANT TO BUY OR SELL a golf course? Exclusively golf course transactions and appraisals. Ask for our catalog. McKay Golf and Country Club Properties, 15485 N. East Street, Lansing, Michigan 48906. Phone (517)484-7726. TF

CURB KING: Curbing machine that lays continuous concrete landscape borders. Low investment, high returns. For information call 303-434-5337 or write PO Box 40567, Grand Junction, CO 81504. 9/89

103 ACRE TURF FARM FOR SALE: Southwestern Ohio, established quality, elite bluegrass blend sod. Large charming country home, good water irrigation potential. Send replies to: P.O. Box 111, Springboro, Ohio 45066. 10/89

EDUCATIONAL OPPORTUNITIES

LANDSCAPING TRAINING OPPORTUNITY: Learn Landscaping at Home. At completion of study, certificate awarded. Get into fascinating field with higher income. Details; Missouri School of Landscaping, 1521 Cutter Ave., St. Louis, MO 63139. Discount to Public Agencies. 9/89

MOVE UP IN THE GREEN INDUSTRY. 2 year AAS Degree program in Golf Course Superintending, Irrigation Management, Landscape Contracting and Park Supervision. 1 year Technicians Certificate Program also available. Fully accredited, VA approved, excellent learning facilities, equipment, and faculty. Graduate job placement assistance available. For information contact: Golf Course Operations/Landscape Technology Department, Western Texas College, Snyder, TX 79549. 9/89

HELP WANTED

NEED LANDSCAPE WORKERS? We can solve any labor problem you have. We have documented workers as well as foremen, leadmen, irrigators and architects available at a price you can afford. Call today! **AMIGOS 214-634-0500.** 10/89

NURSERY FOREMAN: Bissett Nursery Corp., large wholesaler of nursery stock and related goods, looking for hard working individual with minimum 2 years experience in nursery industry. Responsibilities: customer sales and service; material handling and maintenance; deal with people and run small crews. Excellent salary and benefits. Contact Bissett Nursery, Holtsville, NY. Tel. #516-289-3500. 9/89



We are recruiting!

We're looking for knowledgeable people in the following areas:

Environmental Care, Inc.
landscape management

Arbor Care

commercial & industrial arboriculture

Interiorscape Division
interior landscape maintenance

Offices located in:

Arizona	Colorado
Phoenix	Colorado Springs
California	Denver
East Bay	Florida
Inland Empire	Jacksonville
Los Angeles	Miami
Palm Springs	Orlando
Sacramento	Tampa/
Santa Ana	St. Petersburg
San Diego	Nevada
San Jose	Las Vegas
Ventura	Texas
	Houston

Send resume to:

Robert L. Scofield
Personnel Department
24121 Ventura Boulevard
Calabasas, CA 91302

a subsidiary of
environmental industries, inc.
an equal opportunity employer by choice

Landscape Maintenance and Installation Salesperson/Account Representative: Established full service landscape management contractor in Chicagoland seeking a self motivated, aggressive person to work on sales and account development. Excellent opportunity for individuals with a degree or experience in related field. Send resume and references to: Clarence Davids & Sons, Inc., 12807 S. Homan Avenue, Blue Island, IL 60406. 9/89

GROUNDS AND MAINTENANCE SUPERINTENDENT: Hands-on position with beautiful, growing, progressive, privately-owned Cemetery. Responsible for supervising 10-12 people, and all grounds and equipment maintenance. Must have related experience, organization and planning skills, and strong motivation. Send resume and cover letter Resthaven Mortuary and Cemetery, 11800 W. Highway 54, Wichita, KS 67209. 9/89

HORTICULTURE INSTRUCTOR: Virginia Western Community College, a growing comprehensive community college located in Roanoke, VA, serving a population of approx. 250,000 and enrolling approx. 8000 students for fall semester, is accepting applications for a horticulture instructor. This is a full-time, nine-month teaching position responsible for course assignments in landscape and related support courses in the college's A.A.S. degree program in Horticulture Technology. Responsibilities also include administrative duties in recruitment, marketing, and program expansion. Minimum requirements: Bachelors degree with a major in horticulture; minimum two years of occupational experience in ornamental horticulture; excellent teaching skills; and ability to help the department expand and market its curricular offerings. Commitment to instruction, student learning, and academic advising of students in community college setting is essential. Good communication and interpersonal skills are basic to this position. Contract period to begin, preferably, January 2, 1990, but no later than August 16, 1990. For state application contact VWCC Personnel Office, P.O. Box 14005, Roanoke, VA 24038 or phone 703-857-7282. State application, resume, and transcripts of all college coursework completed must be submitted by Friday, September 29, 1989. EEO/AA. 9/89

Ohio landscape construction company wants to expand into landscape maintenance and is interviewing Managers and Supervisors. Excellent compensation package. Send resume or letter describing your experience to: Landscape Managers, 11738 Lake Ave., Suite 203, Lakewood, Ohio 44107. 10/89

Industrial Herbicide Manager/Applicator. Job openings for quality Herbicide Manager/Applicators (in the Southeast, Northeast, and Midwest). Must be motivated and be willing to travel. Mechanical ability desirable. Send resume or call: Weeds Inc., 520 West Cobbs Creek Parkway, Yeadon, PA 19050. (215)727-5539. 9/89

"Consider all of your employment options in the irrigation and landscape industries. Call **Florapersonnel**, the international employee search firm for the ornamental horticulture industry. Completely confidential. Employer pays fee. **Florapersonnel, Inc.**, P.O. Box 1732, 1450 S. Woodland Blvd., Suite 201, DeLand, FL 32721-1732. (904)738-5151. Jim Bambrick, Jeff Brower, David Shaw, CPC, Bob Zahra, CPC." TF

LANDSCAPE MANAGEMENT SALESPERSON: Leading Kansas City Landscape Company has immediate opening for talented, experienced, and aggressive person in Landscape Management Sales. B.S. in Horticulture or related field preferred. Salary, incentive, benefits. Send a resume with experience and salary history to the address listed. **HERMES LANDSCAPING, P.O. BOX 14336, LENEXA, KS 66215. 913-888-2400.** 9/89

Lawn Doctor, Inc. needs a graduate Agronomist with a minimum BS Degree for National staff work with franchises on turf programs, training, safety and regulation. Practical experience with warm season grasses a plus; good communication skills a must. Medium travel from New Jersey Corporate Headquarters. (201)583-3200 or resume/salary history to John Buechner, Lawn Doctor, 73 Atlantic Avenue, Matawan, NJ 07747. 9/89

GROUNDS MAINTENANCE PRODUCTION MANAGER: Orlando, Florida Landscape Maintenance firm has position available for proven manager/leader. We are a rapidly growing company needing a team player capable in all areas associated with landscape maintenance. Abilities must include: planning, scheduling, training, purchasing, client relations, and quality control. Starting salary is \$30,000 plus. Vehicle and benefits provided. Applicants please respond to LM Box 472. 9/89

FOR SALE



A UNIQUE NEW CART CONCEPT

Molded One Piece Tub • 6 Bu Capacity
Simple Assembly • Light Weight (40 lbs)
Will Carry Liquids • No Rust or Rot
Stable & Easy Handling • Stores Easily
Rugged Steel Axle • Easy Dumping
Excellent Balance • Hundreds of Uses

KADCO, U.S.A.

9 Granger Ave., Saratoga Spgs, NY 12866
(518) 587-2224

ATTENTION LANDSCAPERS: FREE CATALOG
Wholesale pricing on blades, belts, catchers, tires and more. Over 500 guaranteed parts to fit Bobcat, Bunton, Exmark, Deere, Scag and other riders and walk behinds. Outstate Call 1-800-343-4333 in Michigan call 313-949-8031 **LAWN CARE PARTS UNLIMITED DELIVERS SAVINGS COAST TO COAST!** We've got your parts!! 11/89

HYDRO-MULCHERS AND STRAW BLOWERS
New and used. **JAMES LINCOLN CORPORATION**, 3220 S. Jupiter Rd., Garland, TX 75041. (214)840-2440, (800)527-2304. TF

88 FORD 5610 NUNES MOWER

Designed to mow large areas of turf grass. 17 foot cutting width. Cutting speed up to 6 mph. Large flotation tires. Excellent condition. Artistic Maintenance 714-458-2605

Lawn Mowing/Maintenance and snow removal business. Established 1966. Owner wants to retire and will consider working with buyer. Doing about 100K per year. Location Southwestern Michigan. Call 616-651-8005. 9/89



PROTECT GRASS FROM AUTO AND FOOT TRAFFIC

INEXPENSIVE, RELIABLE

Call Toll Free
(From a Touch Tone Phone)
1-800-824-9029
Wait for Tone - 753

PAUL FLORENCE Turfgrass: Quality seed for the Turf Professional. Elite Bluegrasses, Fine-Leaf Ryegrasses, and Turf-Type Tall Fescues. Custom mixing our specialty. Silva-Fiber mulch and supplies for hydro-seeders. Quality Elite Bluegrass Sod. Call us! (513)642-7487. 13600 Watkins Rd., Marysville, OH 43040. TF

BIG OX FACTORY CLOSE-OUT! 1989 Mounted 3 Point Hitch Commercial 60" Estate Mowers - \$795.00. 1989 60" Rotary Tillers - \$695.00. F.O.B., Galva, Illinois. Call Jack Dalton, 309-932-2184. 9/89

NINE HOLE GOLF COURSE, 83 acres - well established membership and resort business. \$750,000 - cash. Reply to LM Box 471. 9/89

For Sale: 1988 Lescoe 500, 9 bladed reels, low hours. Also 1985 Ryans Greensair II - completely rebuilt. (413)568-1636. 9/89

Two HiRangers for Sale: 1970 Ford Flat-Bed V-8, 5 speed, 391 CID, Front Mount, 52-foot Boom, \$20,000 nego. 1965 Chev. Utility Bed, 6 Cylinder, 5 speed with 2 speed 292 CID, Rear Mount, 52-foot Boom, \$17,000 nego. Phone: Office (303)659-6427 or Home (303)659-5500. 10/89

STUMP CUTTER: Replacement Head for Rear Hodges & Fox. You'll have the fastest, safest portable stump in the world. Satisfaction money back guarantee. No gimmicks. U.S. Pat. Kinetic Stump Cutter Inc. Toll free 800/422-9344. 2/90

Very profitable 19 year old Lawn and Landscaping Company servicing Northern New Jersey. Hundreds of active accounts. Spray and granular applications. Recently added full service landscaping. Much equipment. Retiring to Florida. Marty Teitelbaum (201)492-1189. 9/89

Spyder Replacement Parts: Complete stock of Spyder repair parts. Stock includes hydraulic components, seal kits, hoses, seats, unique Spyder parts, tires, wheels and much more. Authorized Kohler engine dealer; also Kubota, Onan and Ruggerini diesel engines and engine parts available. Optional equipment and conversion kits. Remote air cleaner. Heavy duty Wilton hub. Nichols-Fairfield torque hub. Extend-A-Fork assembly. Heavy duty assembly. With one of the original co-inventors of the Spyder Forklift and a fully equipped shop at your disposal, all of your troubleshooting needs can be met. **MOBILE LIFT PARTS, INC.**, 5402 Edgewood Road, Crystal Lake, IL 60012. (815)455-7363 or (800)397-7509. 10/89

1987 Ryan sod cutter, 18", \$1500. Kabota 225 duel turf tires, \$3000. Offers. 408-462-1297. 9/89

LAWN SEED: Wholesale. Full line of top quality grasses. Improved bluegrass varieties, fine fescues and fine bladed ryegrasses. We specialize in custom mixing. Oliger Seed Company, 89 Hanna Parkway, Akron, OH 44319. Call collect (216)724-1266. TF

REINCO HYDROGRASSERS and power mulchers in stock. Opdyke Inc. (Philadelphia Area) 215-721-4444. TF

FOR SALE: Landscape Construction Co. North-eastern Illinois. Owner retiring. (312)469-5812. 10/89

Bowie Hydromulcher 1100: Trailer mounted with extra duty suspension and extra wide tires, Kubota Diesel powered with heavy duty clutches and powertrain, centrifugal pump and electric hose reel with hose. Well maintained. No rust. \$11,900. Call Gary at (317)873-5231. 9/89

Finn Hydroseeders, Mulch Spreaders, Krimpers, Pit Burners, Fiber Mulch & Tackifiers. New & Used. Wolbert & Master, Inc., P.O. Box 292, White Marsh, MD 21162, 301-335-9300. TF

ZOYSIA SOD

Meyer Z-52 Zoysia Sod
40 acres of good quality available

Contact: Terry Buchen
Golf Courses of America
Wichita, Kansas
(316) 744-0400

ATTENTION GOLF SUPERINTENDENTS: Great Meyer Zoysia for your Fairways and Tees. Guaranteed Bermuda & fire ant free. Beauty Lawn Zoysia (Cincinnati) 1-513-424-2052. 12/89

PIPE LOCATOR INEXPENSIVE! Locates, traces underground drain, water pipe lines of clay, PVC, ABS, steel, cement. Finds sprinklers, valves, clogs. Bloch Company, Box 18058, Cleveland, Ohio 44118. (216)371-0979. TF

TORO PARKMASTER: 1975 7 gang. New reels & bed knives. Excellent condition. \$6,000. Also, Roseman Gang Mowers, 38 units. Good condition. \$200 each. 215-598-7155. 9/89

ESTABLISHED, 30-year profitable tree business (summers) and snow plowing (winters) for sale due to pending divorce. Pittsburgh, PA. Have all equipment, vehicles and loyal clientele. Annual revenue near \$70,000. Must sell ASAP. Will sacrifice for \$50,000 negotiable. \$25,000 down; \$25,000 in 12 months. Call Dave 412-766-6414. 9/89

ZOYSIA MEYERS Z-52 SOD OR SPRIGS. EXCELLENT QUALITY DELIVERED ANYWHERE AT REASONABLE PRICES. ALSO ROW PLANTING AVAILABLE. DOUBLE SPRINGS GRASS FARM, SEARCY, AR. 1-800-458-4756. TF

USED EQUIPMENT

NEW and USED EQUIPMENT--Asplundh, Hi Ranger and Lift-all forestry bucket trucks, Chippewa wood chippers. Mirk, Inc., (216)669-3567, (216)669-3562, 7629 Chippewa Road, Orrville, Ohio 44667. TF

BUCKET TRUCK: Hi Ranger 65', 57', 50'. Skyworkers with chip boxes. Asplundh brush chippers with chip boxes. Asplundh brush chippers. Bean 55 gal. sprayers. Pete Mainka Enterprises, 633 Cecilia Drive, Pewaukee, WI 53072. 414-691-4306. TF

For sale - Used Equipment. 44" **VERMEER TREE SPADE** mounted on a 1983 Ford 600 truck. Gear shift; Very good condition. Moves a wide range of shrubs and small caliper trees. If interested contact, Property Services; Richmond, VA. (804)320-0035. \$12,500. 9/89

BRUSH CHIPPERS-STUMP CUTTERS: NEW/USED/TRADE. Stocking full line of Brush Bandit Disc Chippers, 6 in. - 12 in. capacity. Rayco Stump Cutters from 20 HP to 75 HP. Hawkensen Enterprises, P.O. Drawer 766, Plymouth, NH 03264. Or call (800)258-8970. 10/89

BUCKET TRUCKS, Straight Stick, Corner Mount and Knuckle Boom Cranes. Brush Chippers - New Morbark Disc Type, New Woodchuck Drum Type. Best prices anywhere. Used Chippers - Asplundh, Woodchuck, etc. 2 to 8 usually in stock. Sprayers, Dumps, Stakes, Log Loaders, Crew Cab Chip Box Dumps, Railroad Trucks, 50 in stock. Sold as is or reconditioned. Opdyke's, Hatfield (Philadelphia Area) 215-721-4444. TF

REPS WANTED

Territory Sales Representatives

Industry leader in revegetation and erosion control products is seeking territory managers for the Northeast and Southeast U.S. Regions. Experience or education in landscape, horticulture or related field a plus. Excellent compensation and benefits package. Send resume to:

Mr. Butman, Regional Sales Manager
Conwed Fibers
1138 Thornwood Ct., Lake Zurich, IL 60047
(E.O.E.)

EXPERIENCED MANUFACTURER'S REPRESENTATIVE: If you are successful in selling specialty turf products to golf courses, landscape and lawn care customers, you can earn high commissions by selling "VITERRA GELSCAPE", the best water management superabsorbent, and AGLUKON's turf micronutrient suspensions. Training, leads, technical support provided. New territories open. Reply on letterhead stating present product lines you represent. AGLUKON USA, Division NOR-AM Chemical Company, 50 N. Harrison Avenue, Congers, NY 10920. 9/89

SALES REPRESENTATIVE: We're looking for special energetic individuals to fill our full-time sales representative positions. If you are a self-motivated, "people" person, we offer a great opportunity for interesting and challenging work in either our northern or southern California territories. Target Specialty Products is a full-line distributor of specialty agricultural chemicals and supplies. Degree in one of the biological sciences required. Ornamental/nursery experience is preferred. Salary commensurate with experience, plus commission and auto. Excellent company benefits, including medical and dental coverage, profit sharing and incentives. Send resume to Target Specialty Products, P.O. Box 1117, Cerritos, CA 90702. 9/89

WANTED

WANTED: Large Lindig and Royer Shredders. Lewis Equipment, 320 Third Street S.W., Winter Haven, FL 33880. (813)294-5893. 11/89

MISCELLANEOUS

FREE PARTS CATALOG-- If you own a 36"-48"-52" walk behind mower and you feel you're paying too much for parts, call Preco Distributors toll-free and request our parts catalog. **BELTS, BLADES, GRASS CATCHERS, WHEELS AND LOTS MORE!** Replacement parts that fit: **BOBCAT, BUNTON, KEES, EXMARK & OTHERS.** 1 day shipping coast to coast available. All parts carry a 90-day warranty. Don't wait, call 24 hours a day. **TOLL-FREE 1-800-428-8004, in Mass. 413-596-5505. PRECO DISTRIBUTORS, 97 Center St., Ludlow, MA 01056.** TF

LANDSCAPE TRAINING VIDEOS

Intermediate mower maintenance field and shop repair; efficient/profitable mowing techniques; professional shrub trimming, plant installation, basic landscape plan drawing, etc. **ENGLISH AND SPANISH.** Write for free brochure.

C.D. Anderson Landscape Videos
515 Ogden Avenue
Downers Grove, IL 60515
1-800-937-0399

SERVICES

TURFGRASS PRODUCT MARKET CONSULTANT: Dr. William Barone, Box 6841, Leawood, KS 66206, 913-341-3319. 9/89

send a **Classified Advertising** message...
...write here.

(Please Print) _____

1. Number of insertions: (circle) 1 2 3 6 12 TF (Til Forbid)
2. Start with (month) _____ issue. (Copy must be in by 5th of month preceding)
3. Amount enclosed: \$ _____

To keep our rates as low as possible, payment must accompany order.

SIGNATURE _____ DATE _____

NAME _____ COMPANY _____

STREET _____

CITY _____ STATE _____ ZIP _____

PHONE NUMBER _____

MAIL AD COPY TO: Dawn Nilsen, **LANDSCAPE MANAGEMENT**, 1 East First Street, Duluth, MN 55802.

RATES: \$1.20 per word (minimum charge, \$35). Boldface words or words in all capital letters charged at \$1.45 per word. Boxed or display ads: \$100 per column inch, one time; (one inch minimum); \$95, three times; \$90, six times; \$85, nine times; \$80, twelve times. (Frequencies based on a calendar year). For ads using blind box number, add \$15 to cost of ad.

ADVERTISER INDEX

NO.	ADVERTISER	PAGE NO.	NO.	ADVERTISER	PAGE NO.	NO.	ADVERTISER	PAGE NO.
101	Air-O-Later	56	124	Elanco Products Co./ Gallery	20-21	148	Northrup King Co.	96
102	American Cyanamid Co. (Regional)	85	126	Excel Industries, Inc.	19	149	Olathe Manufacturing, Inc.	48
171	Associated Landscape Contractors of America	89	134	E-Z-GO Div. of Textron	36	150	Oregon Tall Fescue Commission	18
104	Aquapore Moisture Systems	55	127	Finn Corp.	51	125	Par Ex	15
105	Aquatrols Corp. of America, Inc.	69	128	Ford New Holland	23	151	Pickseed West, Inc.	16-17
106	B A S F Corp.	71	129	Goossen Industries	52	155	Plastics Safety Systems, Inc.	106
107	Barebo, Inc.	27	130	Grasshopper Co.	44	152	Polaris Industries, Inc.	87
108	Bowie Industries, Inc.	40	131	Great Plains Manufacturing	46	154	Precision Labs, Inc.	74
109	Brouwer Turf Equipment	47	132	Howard Johnson Enterprises	80-81	103	Pro Seed, Inc.	22
110	Bunton Co.	43	133	Jacobsen Div. of Textron	63	153	Promark Products, Inc.	38
111	Ciba Geigy Corp./ Subdue	78-79	272	Jacklin Seed Co.	CV4	156	Promark Products, Inc.	50
112	Continental Bridge	28	135	KLM Bio-Systems, Inc.	88	273	Ransomes, Inc.	67
113	Cub Cadet Corp.	CV3	136	Kubota Tractor Corp.	65	157	Reinco	42
114	Cushman	29	137	Lawrence, Inc.	22	158	Sandoz Crop Protection	12-13
115	Cushman	41	138	Lebanon Chemical Co.	105	159	Scag Power Equipment	53
116	Cushman	49	139	Lesco, Inc.	61	160	Scotts Proturf, O.M.	24-25
295	Cushman	59	290	Lombardini USA, Inc.	45	161	Service Master Co.	99
118	Deere and Co., John	32-33	140	Maruyama Manufacturing Co., Inc.	57	162	Tee 2 Green Corp.	CV2
119	Delavan	14	141	Mobay Corp./Dyrene	75	163	Toro Co.	6-7
120	Elanco Products Co./ Surflan	91	142	Monsanto Co./Expedite (Regional)	2-3	166	Telemark, Inc. (Regional)	93
121	Elanco Products Co./ Surflan	73	142	Monsanto Co./Roundup	2-3	167	Turf Merchants, Inc.	95
122	Elanco Products Co./ Rubigan	73	144	National Mower Co.	35	164	Turf Seed, Inc.	5
123	Elanco Products Co./ Rubigan (Regional)	83	145	National Mower Co.	37	168	Verti Drain	70
			146	National Mower Co.	39	169	Walker Manufacturing	68
			147	Nor Am Chemical Co.	77	170	Wells Cargo Inc.	54

This index is provided as an additional service. The publisher does not assume any liability for errors or omissions.

Grounds Managers

This Is What PGMS Is Doing For You



If you haven't checked out the Professional Grounds Management Society recently, then you're in for a surprise. We're offering a bundle of new benefits that make joining PGMS more rewarding than ever! Here's what we've been up to and how you can benefit:

ANNUAL CONFERENCE AND TRADE SHOW - The yearly forum bringing together grounds managers, top speakers, and suppliers for the sharing of knowledge and ideas.

NEWSLETTERS - A newsletter is mailed monthly to keep members current on the affairs of the Society and the latest developments critical to successful grounds management.

CERTIFICATION - Voluntary peer review of acceptable competence to enable you to become a Certified Grounds Manager.

RESEARCH AND SURVEYS - Information on operational practices is gathered for dissemination of all members.

INSURANCE - Included in your membership fee of \$5,000.00 accident and dismemberment insurance.

No matter how large or small your operation, **PGMS** is your source for the best, most meaningful grounds management information and help. Your membership investment goes to work for you immediately — that's the PGMS promise. Join now and grow with us!

AWARDS - Members are recognized for outstanding achievement in grounds management. Annual Grounds Maintenance Awards Contest.

GROUNDS MAINTENANCE ESTIMATING GUIDE

GROUNDS MAINTENANCE MANAGEMENT GUIDELINES

GROUNDS MANAGEMENT FORMS & JOB DESCRIPTIONS GUIDE

WORKSHOP TRAINING - Management skills covering all aspects of grounds management. Available to all sections of the country.

DISCOUNTS - Members receive discounts on Hertz, Avis and Alamo Rental Cars as well as discounts on a complete line of horticultural publications.

Clip and mail to:
**PROFESSIONAL GROUNDS
 MANAGEMENT SOCIETY**
 12 Galloway Avenue
 Suite 1E
 Cockeysville, Maryland 21030

(301) 667-1833

Send me more information on what PGMS can do for me.

Name

Company

Street

City & State

Zip Phone

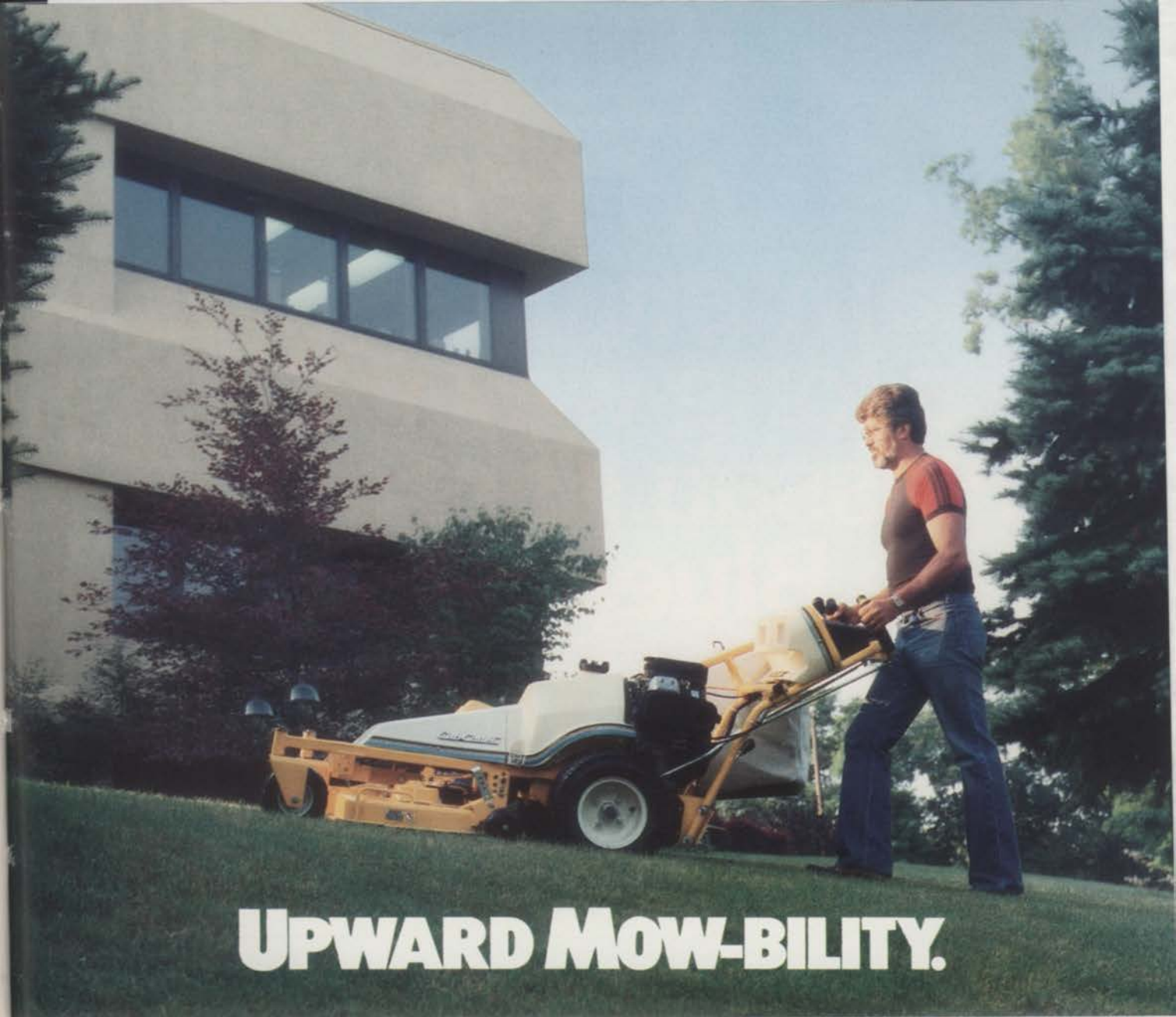

UPWARD MOW-BILITY.



Positive, non-slip drive.

The true test of any grounds maintenance tractor is uphill mowing—especially on wet grass. The Cub Cadet GMT—with positive final wheel drive—has

the consistent power to handle steep grades and wet turf. No slipping. No sliding. Just upward and onward.

Oversize grass-gripping tires.

When the going gets wet, you'll really appreciate Cub Cadet's 16" diameter x 7.5" Turf Tread tires that deliver outstanding traction



and stability. When the going gets rough, you'll like our pneumatic front tires with a built-in puncture sealant that helps prevent flats.

The tough machine that does it all.

Choose from three powerful engines: 8.5 HP, 12.5 HP, 15 HP. Full-pressure lubrication for hillside cutting. Unique planetary 5-speed transmission that provides no-stop, no-clutch forward/reverse shifting. Power unit converts to a snowthrower, sweeper, dump cart, shredder/chipper, sprayer, and more—for year-round utilization.

Grounds maintenance doesn't have to be an uphill struggle. Switch to a powerful Cub Cadet GMT. It makes molehills out of mountains.

Contact Cub Cadet Corporation, P.O. Box 360930, Cleveland, Ohio 44136.

Cub Cadet

Power Equipment

GROUNDS MAINTENANCE TRACTORS

Circle No. 113 on Reader Inquiry Card



A little maintenance goes a long way with Nassau Kentucky Bluegrass.

Why is Nassau a low maintenance bluegrass? Because it requires less fertilizer to maintain a dark green color, has superior drought tolerance, produces less thatch compared to other varieties while having excellent resistance to Fusarium blight,

leaf spot, red thread, pink snow mold, stem rust, and stripe smut. This resistance decreases the need for costly fungicide applications.

Nassau is a hybrid variety (P-59 X Baron) developed by Dr. C. Reed Funk of Rutgers University.



 **LOFTS
INC.**

Bound Brook,
New Jersey 08805
1-800-526-3890
1-201-356-8700

**Jacklin Seed
Company**

West 5300
Jacklin Avenue
Post Falls, Idaho
83854-9499
1-800-635-8726
1-208-773-7581