



Profile nozzles for **Toro®**

<b>730 SERIES</b> Full Circle: Front/Rear Nozzle Set		
Part #	Nozzle Color # range/spreader	Toro Noz #
T730-3313	Brown 33 / Gray 13	33
T730-3413	Blue 34 / Gray 13	34
T730-3515	Violet 35 / Red 15	---
T730-3515L (50 psi)	Green 35 / Red 15*	35
T730-3615	Red 36 / Red 15*	36
T730-3617	Red 36 / Lavender 17	

\* For square spacing, specify #17 (lavender) nozzle with the #35 and #36 range nozzles



Profile nozzles are so consistent, with distribution patterns so uniform... it's like rain on demand.™



<b>760 and 860 SERIES</b> Part Circle: Midrange/Close-in Nozzle Set	
Part #	Nozzle Color: midrange/close-in
T760-GY	Gray / Yellow
T860-GY	Gray / Yellow



<b>830, 834S, DT SERIES</b> Full Circle: Midrange/Close-in Nozzle Set		
Part #	Nozzle Color: midrange / close-in	Toro Series
T830-GY	Gray / Yellow	830
T834-GY	Gray / Yellow	834S
TDT100-GY	Gray / Yellow	DT 34/35



<b>835S SERIES</b> Full Circle: Midrange/Close-in Nozzle Set	
Part #	Nozzle Color: midrange / close-in
T835S-WP	White / Plug

**630 SERIES** CALL FOR AVAILABILITY



<b>670 SERIES</b> Full Circle: Rear Nozzles	
Part #	Nozzle Color: midrange / close-in
T670-BY	Black / Yellow



<b>690 SERIES</b> Full Circle: Rear Nozzle	
Part #	Nozzle Color: spreader
T690-G	Gray



<b>750 SERIES</b> Full Circle: Front/Rear Nozzle Set		
Part #	Nozzle Color #range / spreader	Toro Nozzle #s
T750-5617	Red 56 / Lavender 17	56
T750-5717	Gray 57 / Lavender 17	57

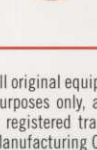

<b>780, 854S, DT SERIES</b> Midrange/Close-in Nozzle Set		
Part Circle (780), Full Circle (854S), Part/Full Circle (DT 54/55)		
Part #	Nozzle Color: midrange / close-in	Toro Series
T780-BY	Black / Yellow	780
T854-BY	Black / Yellow	854S
TDT150-BY	Black / Yellow	DT 54/55

<b>855S SERIES</b> Full Circle: Midrange/Close-in Nozzle Set	
Part #	Nozzle Color: midrange / close-in
T855S-PP	Pink / Plug

**650 SERIES** CALL FOR AVAILABILITY



Profile nozzles for **Rain Bird®**

<b>EAGLE 700 SERIES</b> Full Circle: Midrange/Close-in Nozzles		
Part #	Nozzle Color midrange / close-in	Rain Bird Nozzle #s
R70028-RG	Blue / Gray	28
R70032-RG	Red / Gray	32
R7003640-GG	Blue / Gray	36/40 and larger



**Look familiar?** Poor performing Eagle 700 sprinklers are often the result of clogged and worn nozzles. Profile nozzles' solid metal construction and nozzle shape were scientifically designed to solve this exact problem. They simply don't wear out. And they don't clog. **Upgrade your old golf sprinklers to better than OEM with Profile!**

All original equipment manufacturers, names and products presented in this publication are used for identification purposes only, and we are in no way implying that any of our products are original equipment parts. Toro® is a registered trademark of the Toro Company, Rain Bird® is a registered trademark of the Rain Bird Sprinkler Manufacturing Corporation.



<b>900 EAGLE SERIES</b> Full Circle: Close-in Nozzle	
Part #	Nozzle Color
R900-M	Maroon



<b>91 SERIES BRASS IMPACTS</b> Full Circle: Close-in Nozzle	
Part #	Nozzle Color
R91-G	Gray



<b>51 SERIES BRASS IMPACTS</b> Full Circle: Front/Rear Nozzles		
Part #	Nozzle Color # range / spreader	Rain Bird Nozzle #s
R51-1411.5	White 14 / Gray 11.5	14 / 11.5
R51-1611.5	Blue 16 / Gray 11.5	16 / 11.5
R51-1811.5	Yellow 18 / Gray 11.5	18 / 11.5
R51-2011.5	Red 20 / Gray 11.5	20 / 11.5
R51-2213	Green 22 / Black 13	22 / 13
R51-2413	Black 24 / Black 13	24 / 13





# AuditMaster™

## EXPERT SPRINKLER PERFORMANCE TESTING KITS

Increasing watering times to compensate for poorly performing sprinklers wastes a lot of water. Accurately measuring sprinkler application rates with Underhill™ AuditMaster™ helps maximize water savings.



4" x 5" Marking flags on 21" wire (50-pack) are available in 6 colors.



**AuditMaster Combo ST/LT Kit** pictured, includes large CatchCanPro cups (blue) and CatchCanPro Mini cups (30 each).

**AuditMaster ST Kit** excludes the large CatchCanPro cups. This kit is ideal for **SMALL TURF** audits.

**AuditMaster LT Kit** excludes the CatchCanPro Mini cups, 3/4" Hose Bib and Gauge and the Spray Head Tester w/Gauge. This kit is optimized for golf courses, sports fields and other **LARGE TURF** audits.

# CatchCan Pro™

## features

- Self standing - easily anchors into turf, even on slopes
- Measures sprinkler application in inches or centimeters
- Unique design allows for shorter duration test
- Made of durable polypropylene engineered plastic
- Can be stacked for easy storage
- Each 10 pack kit comes with instructions



CatchCan Pro (CCPK-10) for **LARGE TURF** audits. Measures ml, cm, inches.

CatchCan Pro Mini (CCPMK-10) for **SMALL TURF** audits. Measures inches.

## ordering

Part # AUD-ST	AuditMaster ST Kit	Part # MT-100	Fiberglass Measuring Tape: 100'
Part # AUD-LT	AuditMaster LT Kit	Part # A-FLAG	Marking Flags: Yellow - 50 Pack
Part # AUD-STLT	AuditMaster Combo ST/LT Kit	Part # A-FLAG-B	Marking Flags: Blue - 50 Pack
Part # SALES-PRO4	AuditMaster Wheeled Carry Case	Part # A-FLAG-O	Marking Flags: Orange - 50 Pack
Part # A-STW	Stop Watch	Part # A-FLAG-P	Marking Flags: Pink - 50 Pack
Part # A-WIND	Anemometer (Wind Gauge)	Part # A-FLAG-R	Marking Flags: Red - 50 Pack
Part # CCPK-10	CatchCan Pro (Blue) - 10 Pack	Part # A-FLAG-W	Marking Flags: White - 50 Pack
Part # CCPMK-10	CatchCan Pro Mini - 10 Pack		

# TurfSpy™

## EARLY STRESS DETECTION GLASSES

Disease, drought and weed invasion are plant and turf killers. But by the time you see them it can be too late. TurfSpy™ glasses, with stress detection technology developed by NASA, lets you “see into the future” to identify problems 2-10 days before they are visible to your naked eye. Keep your turf and vegetation healthy BEFORE serious problems arise.



## features

- Shatterproof/polycarbonate stress detection lens (ANSI approved safety lens)
- Wrap-around lens limits ambient light for optimal detection
- Sports frame with adjustable ear piece
- Lightweight case included

## HOW IT WORKS

Dying vegetation absorbs and reflects sunlight differently than when its healthy. The earliest signals occur at the outer limits of the human visual spectrum, and are rendered invisible compared to the predominant middle wavelengths. TurfSpy™ filters the light in the center so that fringe spectra, which show early plant stress, become visible.

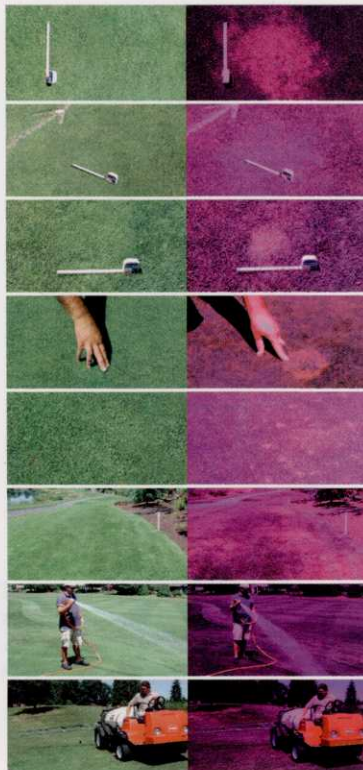

fusarium patch

pythium blight

yellow patch  
(rhizoctonia)

brown patch

anthracnose

get a jump on broken or poor-performing sprinklers

highly efficient spot watering saves time and labor costs

superior weed location and spraying saves time and money



## ordering

Part # NG655-01 TurfSpy™ Glasses and Deluxe Case

# HeadChecker™

## NOZZLE DISCHARGE PRESSURE GAUGE

Use this liquid-filled 160 psi gauge with 30" flex hose and solid brass Pitot tube, hose bib, or spray head adapter to measure water pressure at discharge points.

## ordering

- Part # A-PHG-160K HeadChecker™ gauge, 30" Flex Hose, Pitot Tube
- Part # A-SHG-160K HeadChecker™ gauge with Spray Head Adapter
- Part # A-HBG-160K HeadChecker™ with 3/4" POC Hose Bib Tap
- Part # A-HCGPK HeadChecker™ gauge and Pitot tube
- Part # A-PG160L HeadChecker™ 160 psi pressure gauge only
- Part # A-HCP Pitot tube only
- Part # A-HBT 3/4" Hose Thread x 1/4" Brass Hose Bib Tap
- Part # A-SHA Spray Head Adapter

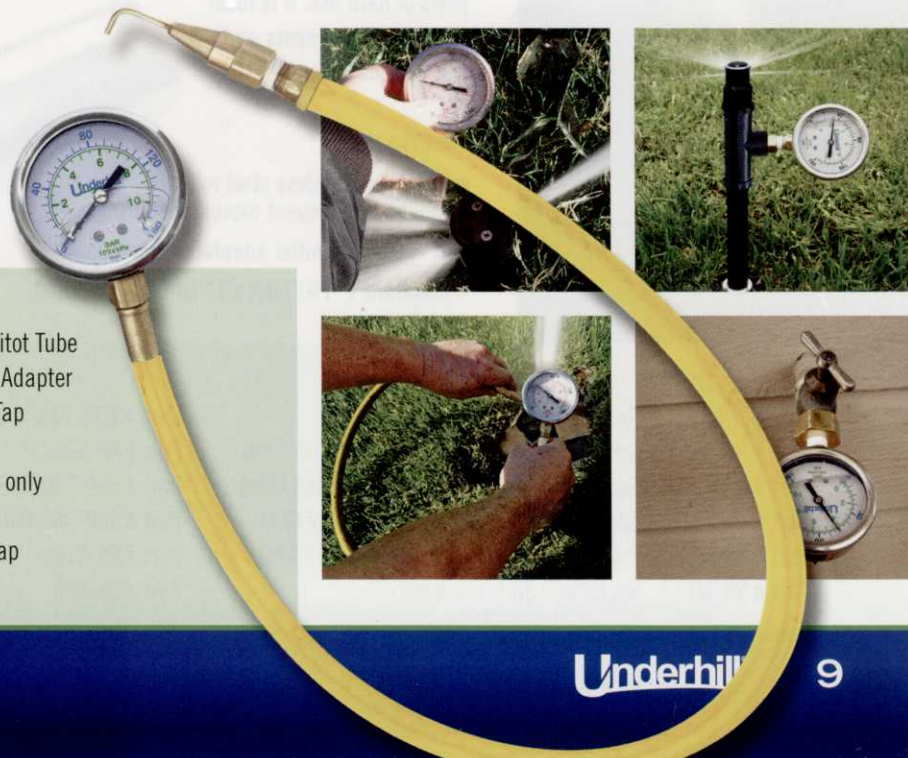



## SpotShot™

### LOW VOLUME PORTABLE SPRINKLER KIT

SpotShot™ is an expandable sprinkler system kit ideal for turf areas requiring low volume watering for extended periods. Connect the Starter Kit to a quick coupler (or golf sprinkler with the HoseTap™ on page 12) and connect Add-On Kits for larger area needs.

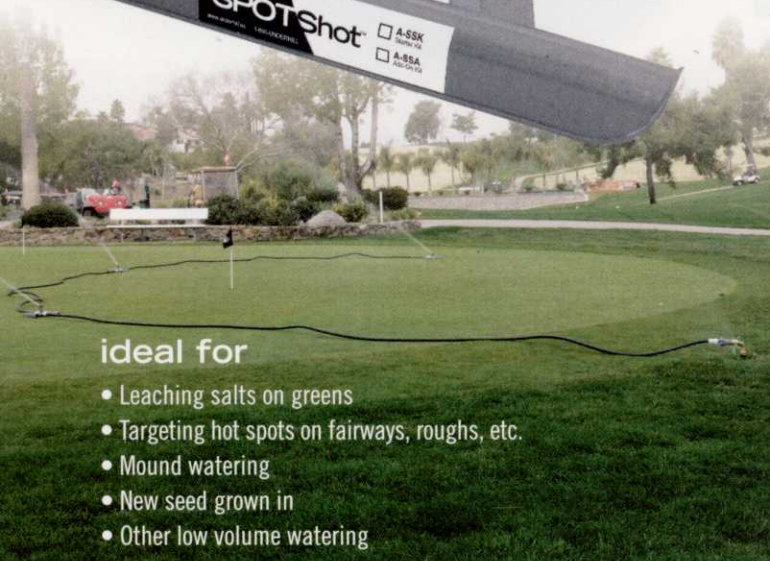

#### ideal for

- Leaching salts on greens
- Targeting hot spots on fairways, roughs, etc.
- Mound watering
- New seed grown in
- Other low volume watering



**Starter Kit** includes 20' of ½" flexible PVC tubing with connection fittings, pressure regulator, sprinkler base and low volume rotating sprinkler (20 ft. radius / 0.65 GPM - 0.16 in./hr.)



**Add-On Kit** includes 20' of ½" flexible PVC tubing with connection fittings, sprinkler base and low volume rotating sprinkler (20 ft. radius / 0.65 GPM - 0.16 in./hr.)



#### Micro-Sprinkler Options

- 20 ft. radius / 0.65 GPM (0.16 in./hr.)
- 20 ft. radius / 1.2 GPM - (0.26 in./hr.)



## RollerPro™

### PORTABLE SPRINKLER BASE

The 22" wide stainless steel roller of RollerPro™ provides a stable field position for supplemental watering. Designed for years of hard use, it is ideal for watering dry spots and newly seeded areas.

#### features

- 22" wide stainless steel roller is weighted to prevent movement during use.
- ¾" inlet and outlet adapters included
- Standard 1" FHT inlet x 1" female NPT outlet



RollerPro™ works with both 1" and ¾" hoses and sprinklers using the included adapters. Sprinklers sold separately on page 12-13.

#### ordering

Part # A-RP221	RollerPro™
Part # SS-SK	SpotShot™ Starter Kit (20 ft. rad, 0.65 GPM)
Part # SS-AOK	SpotShot™ Add-on Kit (20 ft. rad, 0.65 GPM)
Part # SS-SK26	SpotShot™ Starter Kit (20 ft. rad, 1.2 GPM)
Part # SS-AOK26	SpotShot™ Add-on Kit (20 ft. rad, 1.2 GPM)
Part # SS-SB	SpotShot™ Sprinkler Base

Part # R75-HFM-40	Pressure Regulator (40 psi)
Part # TP-050-20	20' Coil of ½" PVC, SuperFlex Pipe
Part # S40-050-HFS	¾" Hose Thread Female x Male, Slip Fitting
Part # S40-050-HMS	¾" Hose Thread Male x Female, Slip Fitting
Part # SS-S16	Micro-sprinkler (20 ft. rad, 0.65 GPM - 0.16 in/hr)
Part # SS-S26	Micro-sprinkler (20 ft. rad, 1.2 GPM - 0.26 in/hr)

# Tracker™

## PORTABLE IRRIGATION MACHINE

The Tracker™ offers an economical solution for supplementing seasonal watering needs of ¼ acre to 2 acre areas. It's also ideal for irrigating athletic fields, cemeteries, golf course roughs, or other large areas where an underground system is impractical. Built to last with precision German engineering and high quality materials, this portable powerhouse can irrigate an entire football field in just two passes.

## specifications

- Weight: 58 lbs.
- Size: Length 33", Width 22", Height 22"
- Materials: Aluminum, Brass, ABS
- Minimum Water Pressure: 50 psi
- Hose Required: 1"
- Includes 1" brass quick-connect adapter



## ordering

Part # T-400 Tracker™ Portable Irrigation Machine

**NEW!**

## Nozzle Locker™ Kits

**STOP LOSING YOUR NOZZLES!**



## ordering

- Part # HP-K1 NozzleLocker™ with ¾" Magnum (yellow) nozzle
- Part # HP-K2 NozzleLocker™ with ¾" Magnum UltraMAX Full Throttle nozzle (high flow)
- Part # HP-K3 NozzleLocker™ with ¾" Magnum UltraMAX Turbo Shift nozzle (high flow)
- Part # HP-K4 NozzleLocker™ with 1" Magnum UltraMAX Full Throttle nozzle (high flow)
- Part # HP-K5 NozzleLocker™ with 1" Magnum UltraMAX Turbo Shift nozzle (high flow)

## THE VERY BEST NOZZLES - KEEP THEM SECURE (and handy)

- Entire Precision™ nozzle series (Rainbow™, Rainmaker™, Cloudburst™ and Cyclone™)
- Solid Brass High-Flow Valve
- CoolPro™ with Precision™ fogging nozzle
- Your choice of MAGNUM™ multi-pattern nozzle (original, UltraMAX Turbo Shift, or UltraMAX Full Throttle)
- Unbreakable, lockable, corrosion-proof case to keep these tools safe and secure





# Quick Coupler Valves & Keys

## SOLID BRASS, SINGLE SLOT/LUG ESSENTIALS

Built to last, Underhill valves and keys are constructed of solid red brass and stainless steel. Valves incorporate rugged one-piece design.

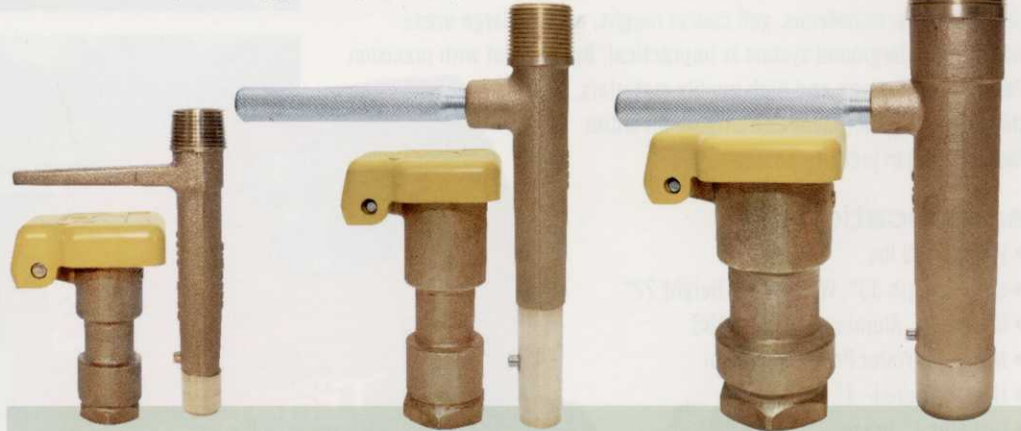

Valve: Part # QV-075R  
( $\frac{3}{4}$ " FPT inlet)

Key: Part # QK-075  
( $\frac{3}{4}$ " MPT x  $\frac{1}{2}$ " FPT outlet)

Valve: Part # QV-100R  
(1" FPT inlet)

Key: Part # QK-100  
(1" MPT x  $\frac{3}{4}$ " FPT outlet)

Valve: Part # QV-150R  
( $1\frac{1}{2}$ " FPT inlet)

Key: Part # QK-150  
( $1\frac{1}{2}$ " MPT x  $1\frac{1}{4}$ " FPT outlet)

## hose swivels

- Part # HS-075  $\frac{3}{4}$ " FPT x  $\frac{3}{4}$ " MHT outlet
- Part # HS-100 1" FPT x  $\frac{3}{4}$ " MHT outlet
- Part # HS-101 1" FPT x 1" MHT outlet
- Part # HS-151  $1\frac{1}{2}$ " FPT x 1" MHT outlet



The Claw™ pictured with 1" quick coupler, key and hose swivel.

## The Claw™

### QUICK COUPLER MOTION RESTRAINT

When quick coupler valves become unscrewed from swing joints, it's more than just a hassle - it can be dangerous. The Claw™, new from Underhill, offers a simple solution. Embedded in the soil below the quick coupler, and then securely attached to its base, The Claw provides significant resistance to rotational, vertical and horizontal motion, preventing the valve from moving. Made from high strength ductile iron, this compact anchor attaches easily with a single steel bolt.

### EASY RETROFIT!

Installs without removing valve or valve box!

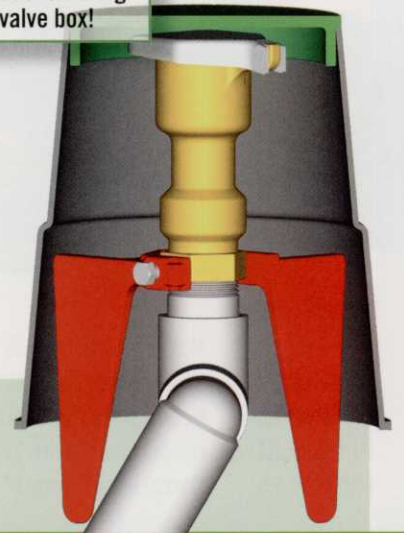

## ordering

- Part # QCA-075100 The Claw™ for  $\frac{3}{4}$ " and 1" valves
- Part # QCA-150 The Claw™ for  $1\frac{1}{2}$ " valves

# Impact Sprinklers

## SOLID BRASS, ULTRA-RELIABLE WORKHORSES

For reliable, trouble-free, high-performance year after year, you just can't beat our brass impact sprinklers. Available in full circle and full/part circle, in inlet sizes of 3/4", 1" and 1 1/4".

### features

- Solid brass construction
- Stainless steel drive spring
- Bearing assembly hood for longer wear life
- Chemical resistant bearing seals
- Solid brass nozzle



Underhill brass impacts atop the RollerPro™ portable base (see page 10) puts a powerful sprinkler anywhere you can run a hose.



3/4"

Flow: 5-15 GPM  
Spacing: 40-60 ft.



1"

Flow: 15-45 GPM  
Spacing: 50-80 ft.

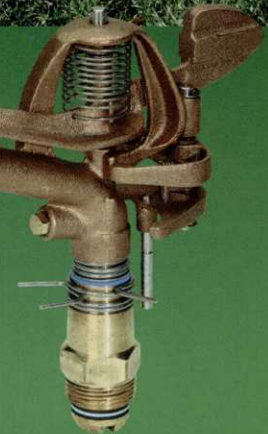

1 1/4"

Flow: 25-120 GPM  
Spacing: 75-110 ft.

### ordering

		GPM	Radius (ft.)
Part # SI075F	3/4" MPT Full Circle	13	57
Part # SI075P	3/4" MPT Part/Full Circle	11	48
Part # SI100F	1" MPT Full Circle	23	71
Part # SI100P	1" MPT Part/Full Circle	23	71
Part # SI125F	1 1/4" MPT Full Circle	51	96
Part # SI125P	1 1/4" MPT Part/Full Circle	54	78

Performance data shown at 80 psi. GPM and radius will vary with pressure at sprinkler

# HoseTap™

## SOLID METAL HOSE ADAPTER

HoseTap™ gives you a hose connection anywhere you have a Toro® or Rain Bird® electric, valve-in-head sprinkler... a fast connection when quick-couplers or hose bibs are not available. Includes aircraft aluminum body (won't break or wear out like plastic) anodized with sprinkler manufacturer color, o-ring, riser, 1" brass swivel and 3/4" adapter. Also available without brass swivel/adapter.



Includes HoseTap, 1" MHT brass swivel and 3/4" adapter

### ordering

- Part # HN-T100S HoseTap™ for Toro® 1" inlet golf sprinklers
  - Part # HN-T150S HoseTap™ for Toro® 1 1/2" inlet golf sprinklers
  - Part # HN-R125S HoseTap™ for Rain Bird® Eagle 700 Series sprinklers
  - Part # HN-R150S HoseTap™ for Rain Bird® Eagle 900 Series sprinklers
- Includes 1" brass swivel and 3/4" adapter. Add "B" for BSP thread.  
To order without brass swivel: Remove "S" from part number.

### REPLACEMENT O-RINGS

- Part # OR-100 Fits Toro® 1" inlet and Rain Bird® Eagle 700 Series golf sprinklers / HoseTap
- Part # OR-150 Fits Toro® 1 1/2" inlet golf sprinklers / HoseTap
- Part # OR-150R Fits Rain Bird® 1 1/2" inlet golf sprinklers / HoseTap





# SuperKey™

## MULTI-PURPOSE GOLF SPRINKLER TOOL

This ultimate multi-purpose tool designed for Rain Bird®, Toro® and John Deere® golf sprinklers is a must have. Made of stainless steel and composite material, it effortlessly turns Electric-Valve-In-Heads on and off, removes internal assembly snap rings and performs many other sprinkler maintenance chores.

### Fits Rain Bird

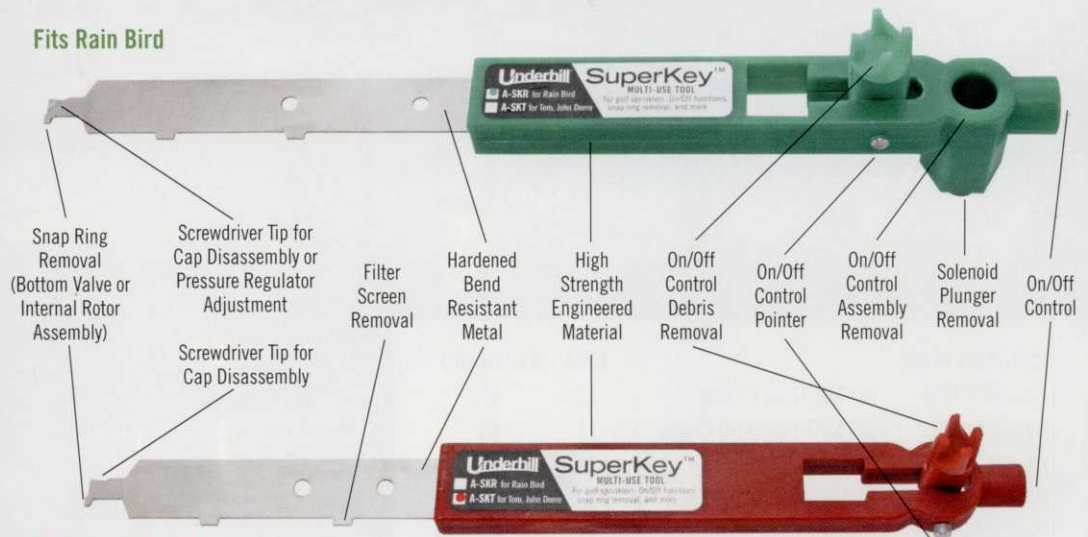

- Snap Ring Removal (Bottom Valve or Internal Rotor Assembly)
- Screwdriver Tip for Cap Disassembly or Pressure Regulator Adjustment
- Filter Screen Removal
- Hardened Bend Resistant Metal
- High Strength Engineered Material
- On/Off Control Debris Removal
- On/Off Control Pointer
- On/Off Control Assembly Removal
- Solenoid Plunger Removal
- On/Off Control

### Fits Toro, John Deere

### ordering

- Part # A-SKR SuperKey™ for Rain Bird® golf sprinklers
- Part # A-SKT SuperKey™ for Toro® and John Deere® golf sprinklers



# VersaLid™

## VALVE BOX UNIVERSAL REPLACEMENT LID

VersaLid™ is the easy solution for broken or missing valve box lids. No need to guess what brand a buried box is or even worse - dig it up to find out - VersaLid's locking system fits all 6"-7" round valve boxes.

### features

- Fits all 6"-7" round boxes
- Universal fit
- Greater top-load strength and more UV-resistant than structural foam lids
- Purple Lid available for non-potable/reclaimed water

**STRONGER! BETTER FIT!**  
than original equipment lids



# Splice Kit

## 3M DIRECT BURY SPLICE KIT

Each kit includes one wire connector which can accommodate wire sizes from 18-10 gauge and a waterproof gel case. Excellent for golf, commercial and residential applications.

### ordering

- Part # VL-6 Green VersaLid™ 6"-7" valve box lid
- Part # VL-6P Purple VersaLid™ 6"-7" valve box lid
- Part # DBRY-4 Direct Bury Splice Kit - 4 Pack





# Gulp™ UltraMAX

## SUPER HIGH-CAPACITY WATER REMOVAL SUCTION PUMPS

Whether you need to remove water from sprinklers and valve boxes or other areas or devices, UltraMax Series Pumps are the ideal tools for the job...huge capacities and the smoothest pumps you will ever use as well.

### special features

- Super Smooth Pumping Action
- Extra Volume Capacity
- Strong Aluminum Pump Shaft
- Heavy-Duty Clear Tube Material
- Self Priming

### also great for



fountains

pipe repair

boats

toilets

spas

and more!

Aluminum shaft



### GULP SYRINGE ULTRA

- 12 oz./stroke
- 12" pump chamber



Contour grip handle

### BIG GULP ULTRAMAX

- 12+ gallons per minute!
- 36" clear pump chamber
- 72" or 36" outlet hose

### GULP ULTRAMAX

- 8 gallons per minute!
- 14" clear pump chamber
- 18" outlet hose

Aluminum shaft



Easy, push-button cleaning system



Gulp UltraMAX and BigGulp UltraMAX include debris filter attachment for very dirty water.

### ordering

- |                  |                                      |
|------------------|--------------------------------------|
| Part # A-G12-C   | Gulp™ UltraMax                       |
| Part # A-G3636CK | BigGulp™ UltraMax w/ 36" outlet hose |
| Part # A-G3672CK | BigGulp™ UltraMax w/ 72" outlet hose |
| Part # A-G12S-C  | Gulp™ Syringe Ultra                  |
| Part # A-GTUB-C  | 100 ft. outlet hose                  |



20505 Crescent Bay Drive • Lake Forest, CA 92630 USA

tel: (949) 305-7050 • fax: (949) 305-7051  
1-866-863-3744 • www.underhill.us



An industry leader in innovative watering products all over the world, Underhill brings 33 years of know-how in developing our inventory of "Products that work...smart.™"

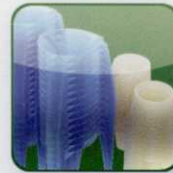

## UNDERHILL INTERNATIONAL PROFESSIONAL WATERING PRODUCTS 2012

© 2012 Underhill International Corporation. All original equipment manufacturers, names and products presented in this publication are used for identification purposes only, and we are in no way implying that any of our products are original equipment parts. Toro® is a registered trademark of the Toro Company, Rain Bird® is a registered trademark of the Rain Bird Sprinkler Manufacturing Corporation, John Deere® is a registered trademark of Deere & Company.



Form No. UIWP-B12

Products that work...smart.™