

ONE WAY TO IMPROVE YOUR WELL EFFICIENCY



The normal operation of any water pumping system inevitably lead to less efficient well production due to pump wear and well plugging.

At Layne-Western we have the resources and expertise to provide you with innovative solutions to keep your water pumping system operating at peak efficiency. Our complete repair and maintenance services help guard against costly breakdowns and quickly solve problems that arise.

Call the Layne professionals with over 100 years of experience in the water supply industry.

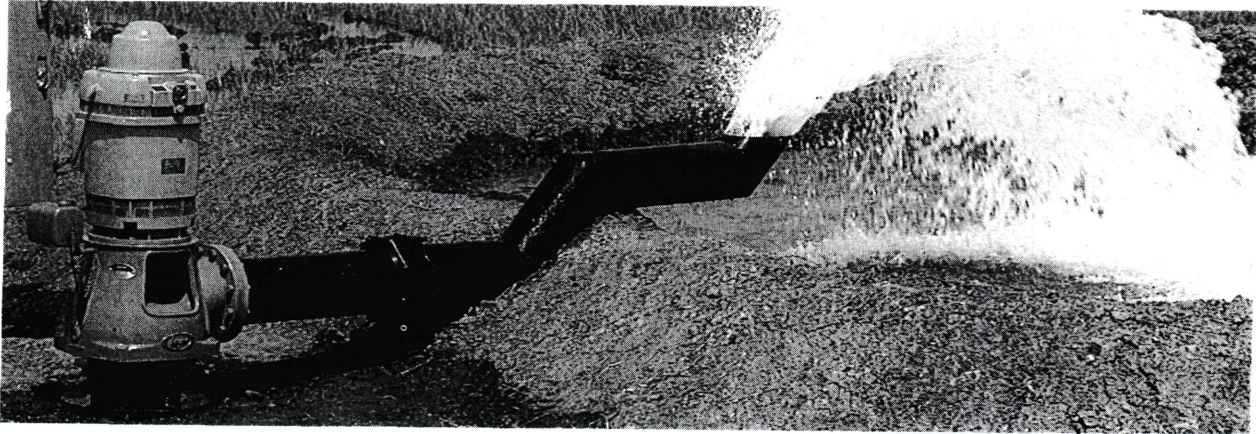

Layne-Western Company

721 West Illinois Avenue • Aurora, Illinois 60506 • 708/897-6941
229 West Indiana Avenue • Beecher, Illinois 60401 • 708/946-2244

**Our Greens Grade Fertilizers
with Dimension® Keep You
Tops In Your Class**

For weed control and fertilization in a single application, you can't beat the high performance, uniformity and results you'll get out of our TeeTime combination products.

Find out more about how you can help your greens make the grade.
Call Craig Filley at 1-800-225-2639.

the professional's partner®

Specializing in Golf Course Renovations

- Tees • Greens • Traps • Fairways
- Hydroseeding • Plant Installation •

company, inc.

don fiore

landscape contractors & architects
golf course contractors

28846 Nagel Court
Lake Bluff, Illinois 60044
708-234-0020
Fax 708-234-0922

Certified Member: American Society of Landscape Architects
Midwest Association of Golf Course Superintendents

Super-n-Site Profile

by Dan Anderson

Kerry Blatteau will host the Midwest meeting on March 12 at the "Golf Club of Oak Brook Hill." Kerry has been the superintendent there since the fall of 1992. He has 15 years of golf course experience along with an Associates degree in turfgrass from Danville Community College and a Bachelors from Illinois State in education. Kerry became a "Certified Golf Course Superintendent" in 1992 through the GCSAA.

The Golf Club hosts many corporate outings and Kerry spends much of his time as a liaison between the pro shop, catering, conference services, and his maintenance staff. He is allowed to do this because he has two very capa-

ble assistants in Steve Schendel and Brian McCoy. They help him with the daily operation of the course so Kerry can spend more time in the hotel area along with its five acres of well manicured landscaping. Kerry believes his biggest challenges are the daily teaching of employees coupled with the constant communication that is required between all factions on the job site. His rewards are watching assistants that he has trained move on to be successful superintendents.

The course was opened in 1987; it's a Dick Nugent design, and Kerry has worked with Dick recently to form a 5 year improvement plan. Most of the improvements will be to fine tune the course layout such as tee spacing, rerouting cart paths, mounding,

landscaping and drainage. The course has come a long way since Kerry arrived, and we wish him continued success. Hope to see everyone there. ■



Kerry Blatteau
Oak Brook Hills G.C.

Best Built - Best Backed - Best Buy - Best Built - Best Backed - Best Buy - Best Built - Best Backed - Best Buy - Best Built - Best Backed - Best Buy

**DID YOU KNOW..... YOU CAN OWN
A VERTI-DRAIN® AND TRACTOR FOR JUST \$23,750.00!!**



Massey Ferguson 1210 2WD Compact Tractor

- 17 HP, 3 cyl. diesel engine
- 9F/3R gear drive with creeper
- Rear and mid PTO
- Turf tires, folding ROPS, horizontal exhaust
- Full, flat operator deck for optimum comfort

(Add \$1800.00 for MF 1231, 60" mid-mount mower shown above when purchased with package.)

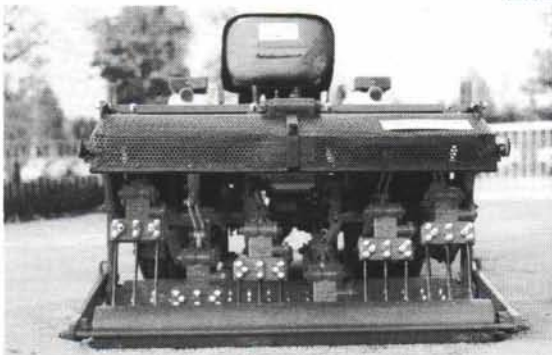

Model 005.120 VERTI-DRAIN®

- 4 ft. working width
- Up to 10 inch working depth
- 2" x 2" hole pattern capability
- 3 point mount, PTO driven
- Solid or hollow core aeration with 8 tine sizes to choose from

**BRYAN WOOD
OWNER**

**COMMERCIAL TURF & TRACTOR
AUTHORIZED DISTRIBUTOR FOR MO, KS, IA, NE, IL**

**800-748-7497
TOLL FREE**

Best Built - Best Backed - Best Buy - Best Built - Best Backed - Best Buy - Best Built - Best Backed - Best Buy - Best Built - Best Backed - Best Buy

We've spent over 140 years learning what works and what doesn't. Let us save you the time.



Hinsdale Nurseries

INCORPORATED
ESTABLISHED 1850

Hinsdale Nurseries Inc. • 7200 S. Madison • Hinsdale, IL 60521 • (708) 323-1411
Yorkville Farm • 8111 Route 34 • Yorkville, IL 60560 • (708) 553-6411

Let FPS Inspect Your System

A neglected pump system can fail at any time, usually when it is needed most!

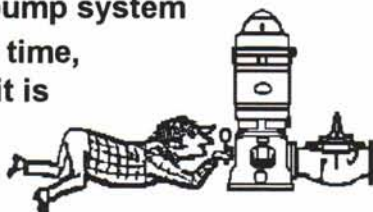

Pump System Specialists

- :We offer the most complete pump system inspections.
- :We will service all motors, controls, pumps & valves.
- :We rebuild all types of pumps.
- :Authorized Flowtronex/PSI service station.
- :24 Hour **EMERGENCY** pager service.

Fluid Pump Service, Incorporated
1000 Lee St
Elk Grove Village, Illinois 60007
Page Chris at (708) 399-9210
or call the office at (708) 228-0750

★ Palatine Oil Company, Inc.

We Specialize in full service.

- Gasoline
- Diesel fuel
- Motor oil
- Grease
- Anti-freeze
- Batteries
- 24 hour delivery
- Tank installation
- Design and layout consulting
- E.P.A. required tank upgrades
- Card lock pump control systems
- Leak detection systems
- Tank removal and disposal
- Contaminated soil remediation

★ State registered tank contractor



708-358-3600

Palatine Oil Co. Inc. P.O. Box 985 Palatine, IL 60078

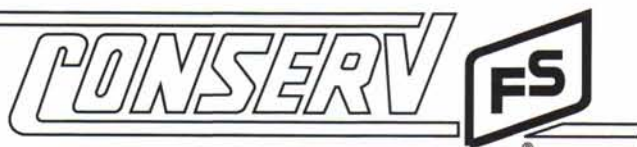

PROFILE
POROUS CERAMIC
SOIL AMENDMENT



Profile a porous ceramic soil modifier that enhances your soil modification program for top dressing and construction material... profile creates the ideal root zone for stronger and healthier roots by increasing...

- ...Oxygen Retention
- ...Nutrient Retention
- ...Increased Microbial Growth
- ...Buffers Soil Temperature

Call Us Today For Further Information

TINLEY PARK
6730 South St.
708-532-4723

WAUCONDA
27310 W. Case
847-526-0007

KANSASVILLE-WI.
4304 S. Beumont
414-878-2048

Golf Courses — A Bluebird Paradise
(continued from page 6)

you observe a nest of long weeds from the top to the bottom of the house, it is a sparrow's nest. Clean out the house. I carry plastic bags with me to put such nests in. Chances are, if it was a bluebird, it will fly back into the house before you get very far away. It takes 6 days to build a nest. Be sure to record your observations.

After the nest is complete, the bluebird will lay one egg a day, usually in the morning, until all eggs are laid. Incubation takes 14 days. Only the female incubates, but both parents feed the young, usually every few minutes all day long. The bluebirds maintain a very clean environment inside the house by carrying out the fecal sacs from the young every time they feed them. The nestlings (the young bluebirds) will remain in the house for up to 18 days after they hatch. When they leave the house, they are called fledglings. You can see from the above information the importance of keeping good records.

After the bluebirds have fledged and you clean out the nest, maybe, if you are lucky, a new bluebird nest will be started. I have experienced that the female bluebird has laid eggs in the old nest before I could clean it out. Bluebirds can have up to three nestings a year, but they usually have two.

When the fledglings leave the nest the first time, they are capable of flying 50 to 100 feet. This is the reason you want a tree nearby. The tree also provides protection for them by hiding them among the branches. The fledglings are not capable of feeding themselves, and the parents feed them for 2 weeks before they are on their own.

Bluebirds usually arrive in Illinois around March 15 each year and leave in the fall around October.

Front Opening Bluebird Slot Box

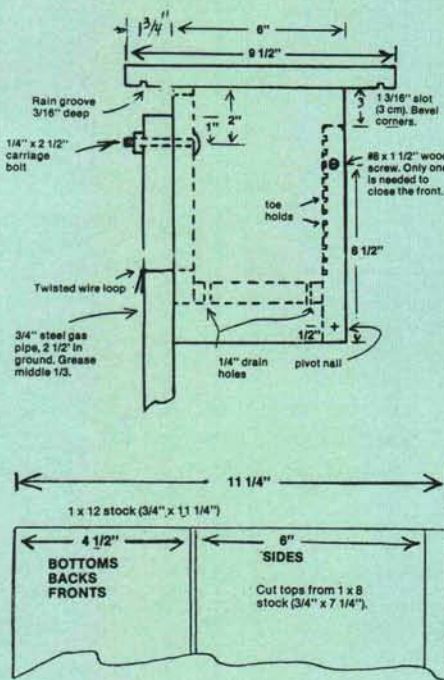

Materials
Use Cedar lumber. Smooth one side, "smooth side in." It is not necessary to paint.

2 sides 6"x9 1/4"
1 front 4 7/16"x8"
(Don't forget toe-holds.)
1 back 4 1/2"x7 1/4"
1 bottom 4 1/2"x4 1/2"
1 top 7 1/4"x9 1/2"

Assembly
Predrill holes for the mounting bolt, wire loop, drain holes, wood screw, and pivot nails. Use #6 siding nails (twisted and galvanized). Glue all permanent joints. Slightly bevel the top corners of the front. Nail the back to the bottom. Add the sides. Make a slot spacer 1 3/16 inches wide and use it when the pivot nails are driven through the sides to affix the front. Add the top.
Predrill a 9/32 inch hole one inch from one end of a 7 1/2 ft. length of steel pipe. Use a post pounder to drive the pipe into the ground 2 1/2 ft. Bolt and wire the box to the pipe, and use a pipe wrench to face the box toward the desired direction.

I have my trail on the Merit Club in Libertyville and am very fortunate that Oscar Miles, Golf Course Superintendent, provides me with a cart, for it still takes 4 hours to do the trail. ■

Editor's Note: Ken Schar has been gracious this month to share with us his success story on bluebirding. Ken first got started back in 1986 when he and his wife, Beverly, attended a program put on by the Lake County Forest Preserve on bluebirds.

He got hooked. He ran a bluebird trail with the forest preserve for many years and then got introduced to Oscar Miles at the Merit Club. He has since been working the 67 bluebird houses there. In 1995 his boxes had 106 baby bluebirds! Ken gives talks on bluebirds to many service organizations and has had displays in local libraries. His address for those of you who may want some pointers on attracting bluebirds is: Ken Schar, 500 Broadway, Libertyville, IL 60048-2323.



AQUATIC WEED
TECHNOLOGY
PROFESSIONAL AQUATIC WEED CONTROL PROGRAMS

Aquatic Weed Technology provides season-long control of aquatic weeds and algae. Through the most effective and efficient methods available, your waterways will be free of unsightly nuisance weeds and algae so you can enjoy the recreational and aesthetic values of your pond or lake.

(708) 893-0810 • P.O. Box 72197, Roselle IL 60172-0197
A division of Clarke Environmental Mosquito Management Co., Inc.

**BANNER[®], SUBDUE[®], TRIUMPH[®]
and PRIMO[®]**

In the NEW turfPak[™]

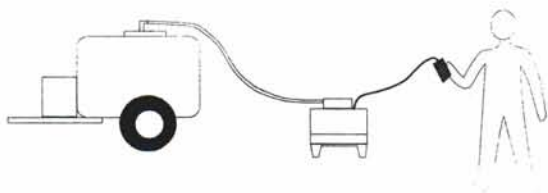

The turfPak[™] is a returnable "closed system" that eliminates container disposal and rinsate concerns. Is a *long term* savings tool that provides an electronic record of the amount of product dispensed. Ask a Clesen sales rep for a demonstration.

FOR INFORMATION CALL:

Arthur Clesen, Inc.



543 Diens Drive Wheeling, IL 60090
(708) 537-2177 FAX (708) 537-2199



The turf tractor for people who despise non-performing investments

The Steiner does the work of a dozen different single-purpose machines. Better. All it takes is a few minutes to change attachments and you're ready to mow, move dirt and snow, edge, blow, chip, aerate and more. All as you move effortlessly across your grounds on a 16 or 20 hp machine with an articulating frame and hydrostatic transmission.

The Steiner. The turf tractor for people who believe in value-based investments and hard work. Test drive one for yourself at your local Steiner dealer.

Financing available through
Dealers Credit, Inc.
(800) 735-1903

STEINER

THE STEINER

A TURF TRACTOR WITH A DIFFERENT TWIST

ROSEMAN TRACTOR EQUIPMENT CO., INC.
2620 CRAWFORD AVENUE
EVANSTON, IL. 60201
PHONE: (708) 864-1842

Scotts Introduces...



Triaform[™] Technology is a superior alternative to any traditional fertilizer you've ever used. It's patented, environmentally sound process dramatically improves the physical characteristics of a homogeneous fertilizer granule while delivering excellent agronomic performance and handling. Triaform technology offers better methylene urea (MU) nitrogen distribution to deliver more available nitrogen to the plant.

An innovation you'd expect from a name you can trust.



For details, call your
ProTurf Tech Rep

or 1-800-543-0006 today.

the Bull Sheet

DATES TO REMEMBER

March 12 — MAGCS monthly meeting at Oak Brook Hills Golf Club

April 4 — CDGA Green Seminar, Drury Lane, Oak Brook

April — MAGCS monthly meeting at Klein Creek

May — Combined ITF meeting in Springfield

June 4 — MAGCS monthly meeting at Odyssey G.C.

July 16 — MAGCS monthly meeting at Heritage Bluffs

August — Need a place to meet

September — MAGCS monthly meeting at Skokie C.C.

October 8 — MAGCS monthly meeting at Bryn Mawr C.C.

Kerry Blatteau is looking for a second assistant for The Golf Club at Oak Brook Hills. Call 708-323-7633 for additional information, or send a resume to: Oak Brook Hills Resort, 3500 Midwest Rd., Oak Brook, IL 60522

Joe Marino is looking for a mechanic's position on a local golf course. Call 708-289-1150.

Albie Stoudt was recognized at the February MAGCS meeting and presented with the GCSAA 45-year service pin. His comment: "It should be a pin for 46 years now." Well done, Albie. Keep on coming and making those motions so we don't have to put up with the reading of the minutes at the previous meetings.

Ray Schei sends his thanks to the membership for their thoughtfulness on sending a plant to him during his recent illness.

Wanted: Assistant Farm Manager. Turf degree and/or pesticide applicator's license a plus. Send resume to: Huber Ranch Sod Nursery, Inc., P.O. Box 188, Schneider, IN 46376.

Attention all you computer buffs... *On Course* is on the Internet, and our e-mail address is: magsoc@aol.com. You can use this to send your articles instead of mailing or faxing them. It is not to be used at the present for chit-chat, for the e-mail is being sent to our graphics artist's box and comes to me secondhand.

For all of you fine people who are going to write articles, for your newsletter, please use Arial (sans serif) style, size 12 font and double space your article.

Gary Galecki at Ridge C.C. is looking for both an assistant and a mechanic for this coming season. Please call: 312-233-8490.

Congratulations to Chris Smith for weathering the 1995 season, as he supervised the construction

of the new 18-hole Bittersweet G.C. Chris is now accepting applications for 10 positions, including a first assistant and a head mechanic. Call: 847-855-9569 or mail resume to Bittersweet G.C., 865 N. Almond Rd, Gurnee, IL 60031.

Landscape Foreman needed: Turf Specialist and Maintenance Foreman positions available in our expanding North Shore design/build/maintenance firm. Duties to include running a crew, installations, client interaction and coordination of activities leading to project completion with a focus on quality. Year-round compensation. Scott Byron & Co., Inc., 30088 N. Skokie Hwy., Lake Bluff, IL 60044. 847-689-6342.

Mechanic needed, good salary and benefits. Contact Don Altman, Forest Hills C.C., Rockford, IL. Call 815-877-0845.

For Sale: Five gang reel mowers, best offer. Call Steve Cummins at Lake Barrington Shores G.C., 847-382-3252.

John Sutton has resigned at Biltmore G.C. and has changed careers. John has gone into the trucking industry to help a friend run his business. Good luck, John.

For Sale: 1983, 3-wheel Cushman w/pto, newer engine and hydraulic pump, good runner, \$1,000. 1986, 4-wheel Cushman w/hydraulic dump, good condition, \$1,200. 1989, EZ-GO GXT, good condition, \$600. 1990, Lesco 500D with 8-blade HD cutting units, 1100 hours, \$2,500. 1983 Jacobsen PTO Model 40 Blower, \$500. 1969 Rogers PTO leaf blower with new chains, \$300.

Roseman 4-blade gang mowers,

(continued on page 20)

Product Profile :
GREENS KING V

NEW

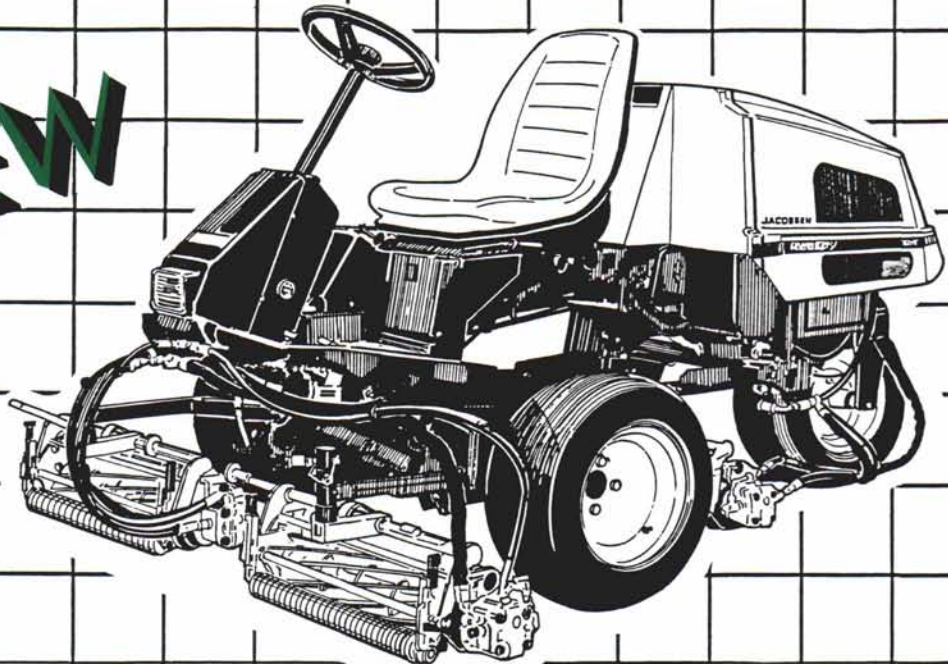

- Operator friendly! Easy on and off
- Flash Attach allows fast removal of reels without tools
- Quiet operation, gas or diesel
- Light weight, balanced design. Ultra light foot print
- Power steering. Turns inside its own radius. Cuts the most difficult greens
- Available with: 11 blade greens reels or 7 blade fairway reels, quick rollers, turf groomers, vertical mowers



illinois lawn equipment, inc.

16450 South 104th Avenue • Orland Park Illinois 60462

708-349-8484



Technology Backed By Tradition

Free Labor!

by Fred Bebnke
Golf Course Superintendent
Mt. Prospect Golf Club

Do divot marks make your fairways look like the surface of the moon?

Does your maintenance center look like Tobacco Road?

Are the corners of your course getting a little fuzzy?

CALL THE POLICE!

No, I don't mean 911 (although there may have been times you have considered it). I mean Sheriff Michael Sheehan's Work Alternative Program, or the Social Service Department of the Circuit Court. Both of these agencies administer a program that gives people convicted of non-violent crimes a chance to "work off" their sentence by performing community service for registered sponsors. If you qualify and register as a sponsor, they will come to your course and work for *FREE*.

The Sheriff's Work Release Program is totally self sufficient. Once you have registered as a sponsor, you call the office to arrange a date, time and location; and a van shows up with a uniformed officer and anywhere from four to twelve offenders. The officer supervises the "crew" the entire time, usually from 9 a.m. to 3 p.m. with one hour off for lunch. This system is very useful for those jobs you can't throw enough labor at, i.e., spring cleaning twigs and branches or soil and seeding fairway divots. We have been able to soil and seed ten acres of fairways in one visit using these guys.

The Social Service Department of the Circuit Court's

Program, on the other hand, is individualized and requires more work on the sponsor's part. You are assigned a program coordinator who refers "clients" to you, and you deal directly with the offender. You will not be rubbing elbows with rapists and murderers. Only people convicted of non-violent crimes are allowed to use the program. I've found that a large percentage of the people that I accept for community service work are DUI convictions — regular people that used bad judgment at got caught. You might even get lucky; one of my "clients" turned out to be a carpenter and redecked two bridges for the cost of the lumber. He even provided the tools.

There are some conditions that the sponsor (you) must meet:

The work to be performed must be for a not-for-profit organization. If your employer is
(continued on page 22)

GOLF MAINTENANCE BUDGET BLUES?

Are your Spray Pattern Indicators costing too much money?

Switch to **SIGNAL™** and \$ave money!!

Get more color for your Spray Pattern Indicator Dollars - use **SIGNAL.**

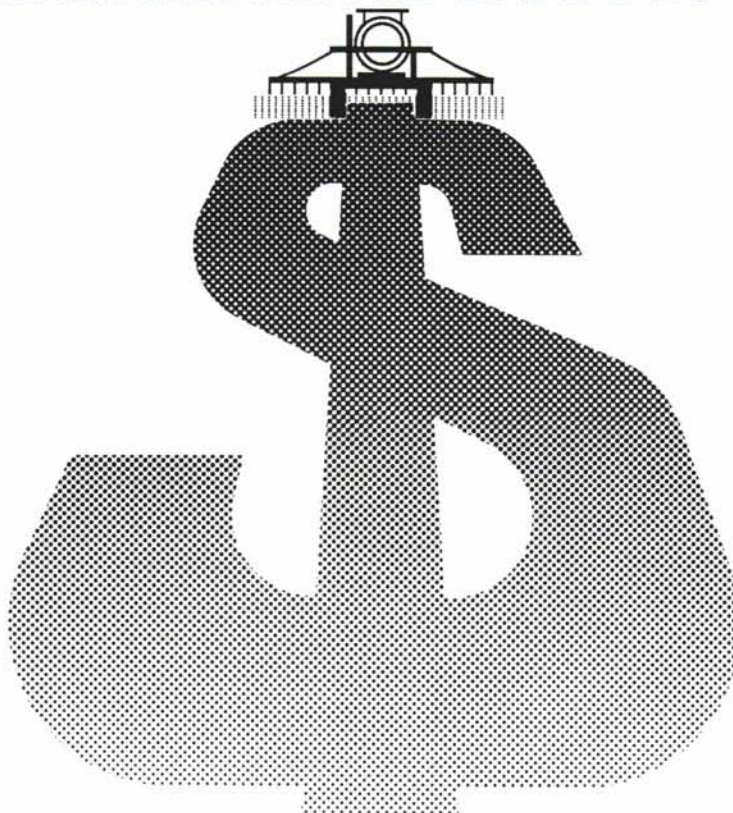

Please call **PRECISION LABORATORIES** for stocking distributor information.

Call us at **800-323-6280**

PRECISION
LABORATORIES INCORPORATED

TOUGH AS NAILS



New Holland Super Boom™ skid-steer loaders are the toughest in the business. That's because they're more durable, reliable and easier to service than any machine on the market.

MARTIN IMPLEMENT SALES, INC.

16400 S. 104th Ave.
Orland Park, IL 60462

(708) 349-8430



PRESSURE WASHERS



250
to
2,000
PSI

NEW AND USED

FREE DEMO

- SALES
- SERVICE
- PARTS
- CHEMICALS

CALL TOLL FREE
1-800-666-3900

*The Cleaning Equipment Specialists Since 1976**



TIM LAYDEN
General Manager

708-893-0777 • FAX (708) 893-1045

1-800-666-3900
Sales Service Parts Rentals Chemicals
25 S. Park Street • Roselle, Illinois 60172



**HALLORAN &
YAUCH, INC.**

IRRIGATION
SYSTEMS

2040 Lehigh Avenue
Glenview, IL 60025
Telephone 847.724.8660
Fax 847.724.8659

- Irrigation Design & Installation
- Drainage Systems
- Pump Station Work & Consultation
- Irrigation Pipe & Supplies

the Bull Sheet

(continued from page 16)

7 units w/frames, \$600.

Contact Kurt or Tony at Exmoor C.C., 847-433-1177.

Midwest Golf Development, a golf course contractor located in northern Illinois, is looking for an equipment manager.

Knowledge of gasoline and diesel engines, welding and fabricating are required. Travel to job sites and a CDL license are required. Please call Gayla at 815-923-1868.

Wanted: Assistant Golf Course Superintendent. Call Steve Van Acker at Crystal Lake C.C., 815-459-7240.

Doug Long has left Streamwood Oaks to become the Vice President of Operations for the Central Division of Crown Golf Properties. His responsibilities will encompass providing assis-

tance and guidance for the on-site management team while reporting to the representatives of the golf course ownership. A sad note that Doug mentioned was that his father had passed away last year. Mr. Long was twice president of Riverside G.C. and an active participant in the Evans Scholarship program.

Fred Jimmy, Illinois Lawn Equipment's longest term employee, retired effective December 31, 1995. Fred, who started grinding mowers on a piecework basis in 1959, has for the last twenty-plus years been involved in the setting up of new equipment. He also delivered new reel and bedknife grinders and instructed customers in their proper use. In addition, he served as the instructor in Illinois Lawn Grinding Schools. For the last several years, Fred has worked part time for Neary Manufacturing, working their

booth at the National, NCTE, the Ohio Turfgrass Show and other regional shows. He also consulted with Neary in the design of their new family of grinders. Fortunately, as Fred will be continuing this role with Neary as well as calling on Neary distributors in the midwest and southeast on a part-time basis, we will still be seeing Fred frequently.

We certainly wish him the best in his new role.

PEERLESS 2000

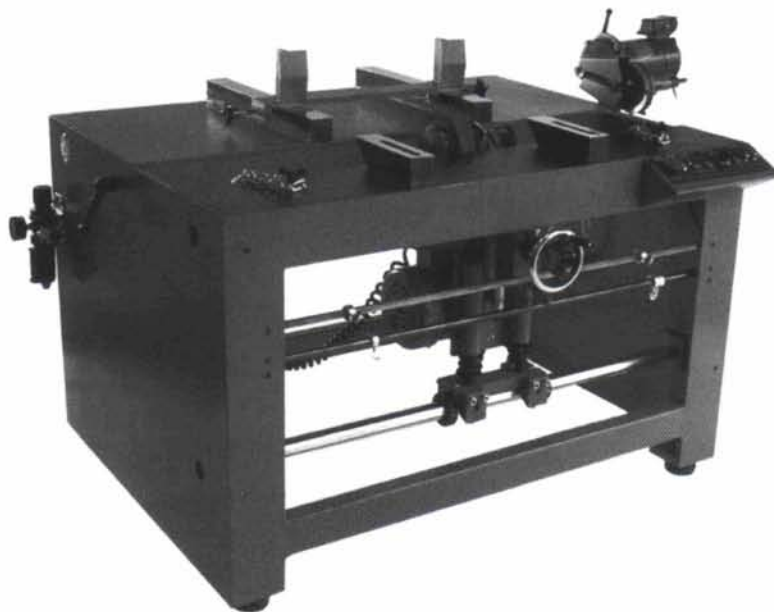

- > Quick Setup
- > Spin Grind
- > Relief Grind
- > Auto Traverse
- > Variable Spin

SIMPLEX-IDEAL-PEERLESS
WE CARRY THE FULL LINE

MIDWEST
TURF & TRACTOR

708-301-8500 or 815-469-8500