

BUYERS GUIDE

SAND/SILICA SAND

F. J. CROW LTD

Specialists in all types of sands and gravels - contact:
Dick Gunn at
Paddon House, 12a, Stortford Road
Great Dunmow, Essex, CM6 1DA
Tel: 0371 875577



The leading supplier of Moneystone Bunker Sand

1a Clifton Street, Alderley Edge, Cheshire
Tel: Alderley Edge (0625) 584571/
585143. Fax: (0625) 586130.

PROFESSIONAL TURF DRESSINGS FOR THE PROFESSION

Sand

All sand requirements catered for including lime free.
Also lime free Horticultural Grit - and Wood Chips. Nationwide deliveries.

Bailey's of Norfolk

Brick Kiln Rd, Hevingham, Norwich, Norfolk NR10 5NL.
Tel. 060 548 607. Mobile 0860 661603

WETTERN BROTHERS LTD

RMC HOUSE · CANNING ST.
MAIDSTONE · KENT ME14 2RX

Telephone (0622) 762361
Contact: Chris Perkins

GARSIDE SANDS



Complete range of dried graded silica sands for all purposes
Contact John Deavan at 39 Hockliffe St., Leighton Buzzard, Bedfordshire LU7 8HB. Tel. (0525) 372201. Fax. (0525) 851572. Telex. 825868

DERWENT AGGREGATES

DERWENT HOUSE, 84 COLLEGE STREET, LONG EATON, NOTTINGHAM NG10 4NP

Supplies of special sands, gravel and stone, various grades of bunker sand.

★

WHITE BUNKER SAND (AS USED AT THE BELFRY)

Drainage Gravel

Sharp Sand for top dressing

Attractive Road Stone for paths and drives.

★

For prompt and efficient service

TEL: (0602) 461001
FAX: (0602) 461576



DRESSINGS FOR FINE TURF

New Platt Wood Sand
Moneystone Bunker Sand
Available in loose bulk loads to all areas.

Contact Jim Burrows at
M & B SUPPLIES
15 Uttoxeter Road, Tean,
Staffs ST10 4LG
Tel. (0538) 722417
Fax. (0538) 723387

BUCKLAND

Sand & Silica Company

COMPLETE RANGE OF HORTICULTURAL SANDS

Contact: Lynda Jordan
Buckland Sand & Silica Co
Reigate Heath, Reigate,
Surrey RH2 9RG
Tel: (0737) 240151

COURSE ACCESSORIES

TACIT

The best for less in
Golf Course Equipment
48 Hillmorton Road
Rugby CV22 5AD
Tel. (0788) 68818

TRENCHERS

CASE TRENCHERS TRENCHER PLANT SALES

Dove Fields, Uttoxeter, Staffs.
Fax: (0889) 563140.
Tel: (0889) 565155

CONSTRUCTION



Golf Build (UK) Ltd

GOLF COURSE AND DRIVING RANGE CONSTRUCTION

Sedlescombe, East Sussex
TN33 0SD
Tel: (0424) 870888
Fax: (0424) 870855

Civic Contract Services

Low ground pressure machinery used for all your on course construction and drainage needs with minimum disruption to play.



Progress Cottage
Buxton Road
Bakewell DE4 1DA
Tel 0629 814269
Mobile 0831 440131



AERATION & DRAINAGE SERVICES



Construction, alteration and drainage - all areas
Contact: Paul Wright
Aeration & Drainage Services
20 Westminster Close,
Eastbourne, Sussex BN22 0LQ
Tel: (0323) 506725
Mobile: (0860) 838241

DRAINAGE

R. A. SLEATH & SON SPORTSGROUND DRAINAGE CONTRACTOR

Specialising in
golf greens construction
and sports ground drainage
20 years experience
Distance no object
Contact: Geoffrey R. Sleath
Tel: Rotherham (0709)
862109 or 862075

GRINDING MACHINES

MOWER GRINDING MACHINES



ERIC HUNTER GRINDERS LTD
Hobson Industrial Estate,
Burnopfield,
Newcastle upon Tyne NE16 6EB
Tel: (0207) 70316.
Fax: (0207) 70312

PUMPS

GRUNDFOS PUMPS

FOR SPORTS & RECREATIONAL
TURF IRRIGATION, BOOSTING
AND WATER SUPPLY

Contact our sales offices today for full information on the Grundfos range

SOUTH: (0525) 850000
NORTH: (0925) 813300

GRUNDFOS

GRUNDFOS PUMPS LTD GROVEBURY ROAD
LEIGHTON BUZZARD, BEDS. LU7 8IL

CLASSIFIED

GOLF MATS/NETS

GOLF LINKS

Manufacturers and suppliers of quality

SYNTHETIC GRASS GOLF MATS AND COMMERCIAL PRACTICE NETS

Trial mats available

Golf Links
17 South Road,
Guildford,
Surrey GU2 6NY
Tel: 0483 68085

FOR SALE

RANSOMES ROUGH CUT GANG MOWER

Triple Unit Mark 13
Fits on to 3 point linkage

AS NEW

£1,800 ono

Tel (0670) 515398
after 5pm

GRASS CUTTING MACHINERY

DANARM ASUKA LAWNMOWERS more for your money!

Top of the Danarm range of rotary mowers - the Asuka TN 215 SXK combines - power with reliability, elegance with superb engineering ...

... and safety features to ensure hours of effortless, safe mowing.



Main features include:

- 20"/21" cutting width
- Powerful Kawasaki FC 150V OHV 4 Stroke engine
- IBC safety system
- Cast aluminium deck
- Seven step height adjustment
- 2-speed transmission
- Large rear grass bag

Fill in coupon and return whole ad to
DANARM A Division of Silverthorne-Gillett Ltd
Victoria Works, Birmingham Road
Dudley W. Midlands DY1 4RL
Telephone (0384) 455461 Fax (0384) 241443

Name
Address

Tel No.

CLASSIFIED

TURF DRESSINGS



Producers and Suppliers of the "Top of the Table"
Range of **Turf Dressings**
Bunker Sands, Screened Loam &
Topsoils, Horticultural Composts.
Telford Way, Telford Way Industrial Estate, Kettering,
Northants. Tel: 0536 510515

MACHINERY HIRE

WORTH CONTRACTORS LTD

Trencher hire:

self propelled low ground pressure machine

Trenches up to 1 metre deep and 3 to 8 inches wide. Can be increased to 1.2 metres deep by 400 mm wide. Oxford wheel attachment which is 50 mm wide by 400 mm deep.

Ideal for **Sportsground Drainage, Sand Slitting and Cable Laying**, etc. - Please contact:

Worth Contractors Ltd., Tring House, High Street, Cranleigh, Surrey, GU6 8RL. Tel: (0483) 274800.

FOR HIRE

VERTI-DRAIN AND AUTO SEEDER FOR HIRE.

CRICKET • GOLF GREENS • RUGBY • OR FOOTBALL PITCH
QUOTES GIVEN

TRACTOR/DRIVER AND VERTI-DRAIN ALL INCLUDED

RING NOW FOR BOOKINGS TEL: (0873) 880244. FAX: 02913 2676

KEITH MORGAN
MOWERS

Any distance covered

COURT WYNDERMERE, BETTWS NEWYDD USK, GWENT NP5 1TJ
TELEPHONE 0873 880244.

ALSO MAIN AGENT FOR JACOBSEN, AGRIA, CHARTERHOUSE AND VERTI-DRAIN



ENGLISH WOODLANDS LTD

VERTI-DRAINAGE

For Golf Courses and other grassed sports areas throughout Kent.

Tel: S. McFarlane

Grounds Maintenance Manager

Tel: (0227) 710694

CLUB SECRETARIES/HEAD GREENKEEPERS
CLEAR FAIRWAY COMPACTION USE A NO MESS "TWOSE TURF CONDITIONER"

All drainage problems cured

Hesketh Plant Hire

LAND DRAINAGE SPECIALISTS

Tel: 0270 71613. Mobile: 0860 371504
Hesketh Plant Hire, Inglewood Farm, Minshull,
Vernon, Middlewich, Cheshire.



SOIL WETTERS

AGRILAND CONCENTRATED SOIL WETTER *puts water to work*

- *bio-degradable*
- *non-ionic, non-toxic, low foam*
- *aids water penetration at less than £5.00 per 500m² application*

AGRILAND

ORGANIC FERTILIZERS LTD

Blue Roof Farm Throop Road Throop

Bournemouth Dorset BH8 0DW

Telephone: Bournemouth (0202) 532291/536458

Telefax (0202) 535224



EQUIPMENT FOR SALE

RANSOMES SUPER 16

Fully Hydraulic
Bunker Rake

500 hours

£3,250 inc VAT

or reasonable offer

Tel: (0633) 894433

and ask for Steve Elms

TORO GREENSMASER 3

With Kohler Engine

5½ years old

Good condition

Well maintained

£2,500 ono

Contact:

Peter Atkinson

Tel (0943) 75570

CONSTRUCTION

Construction specialists in land development

Sportsfields, Golf courses,
Outdoor leisure parks and
conservation plantings.

Conservation & Leisure Ltd

Chapel Farm, By-Pass Road,
Igham, Sevenoaks, Kent
TN15 9AF.

Tel 0732 455244 Fax 0732 350351

RYAN G.A. 30 Hollow corring machine

180 hours work
Immaculate
condition

£5,500 ono

Contact: Richard
Veitch, Bracknell.
Tel: (0344) 860690

One set of **Ransomes Mounted Hydraulic 5 Gang Mowers** 3 years old worked two seasons. Excellent condition and completely overhauled
£5,500 ono

One **Lewis Landlord 200 Backhoe** plus one 36" Ditch Cleaning Bucket with one 13" and one 18" bucket.

Call: The Secretary, Glenberrie Golf Club Ltd
Stirling Road, Larbert. Tel. (0324) 562605

GOLF COURSE EQUIPMENT

THE WORLD'S LEADING GOLF COURSE EQUIPMENT DESIGN AND MANUFACTURER

Specialist items include: Furniture, Greenkeeping and Groundsman's Tools, Tee Plates of all shapes and sizes, Club House and Special Event Flags, Hole Cups for every type of course, Flag Staffs to fit every need.

And for the Driving Range too, a most efficient Ball Collector, Big Capacity Ball Dispensers, Economic Ball Washer, Hard Wearing Tee Mats and Rubber Tees.

H. Patisson and Company, 342 Selbourne Road, Luton, Beds. LU4 8NU
Phone 0582 597262. Fax: 0582 505241

Patisson





THE OFFICIAL PUBLICATION OF THE
BRITISH AND INTERNATIONAL
GOLF GREENKEEPERS ASSOCIATION

1990 BIGGA GREENKEEPER MEMBERSHIP PACKAGE

BIGGA offer a comprehensive membership package for greenkeeper members. The full range of services and benefits is in line with a progressive professional Association, abbreviated details overleaf. Full details are available from Headquarters Office on request.

**JOIN THE OTHER 5324
SUBSCRIBERS TO
GREENKEEPING
MANAGEMENT
Tel. Andrew on 091 4960003
for immediate attention**

BUSINESS REPLY SERVICE
Licence No. NT 1638

2

**GREENKEEPING MANAGEMENT
SPENCER HOUSE
MARKET LANE
SWALWELL
NEWCASTLE UPON TYNE
NE16 3DS**

BUSINESS REPLY SERVICE
Licence No. NT 1638

2

**GREENKEEPING MANAGEMENT
SPENCER HOUSE
MARKET LANE
SWALWELL
NEWCASTLE UPON TYNE
NE16 3DS**



BIGGA 1990 MEMBERSHIP APPLICATION FORM

(not to be completed by 1989 members)

PLEASE COMPLETE FULLY IN BLOCK CAPITALS

GREENKEEPER MEMBERSHIP

FULL NAME.....

HOME ADDRESS.....

COUNTY.....POSTCODE.....

TELEPHONE.....

DATE OF BIRTH.....

PERSONAL QUALIFICATIONS.....

NAME OF EMPLOYER.....

ADDRESS.....

COUNTY.....POSTCODE.....

TELEPHONE.....

POSITION HELD.....

DATE OF APPOINTMENT.....

ASSOCIATE/COMPANY MEMBERSHIP

FULL NAME.....

NAME OF COMPANY (where applicable):.....

PREFERRED MAILING ADDRESS.....

COUNTY.....

POSTCODE.....

TELEPHONE.....

POSITION.....

I hereby apply for membership of the British and International Golf Greenkeepers Association and agree to abide by the constitution and rules of the Association.

Signed.....

Dated.....

REF - GM 6/90

READER REPLY PRE-PAID CARD

Join over 5,000 subscribers who are bang up to date on greenkeeping throughout Europe. Improve your knowledge and subscribe to Greenkeeping Management today.

Please check the appropriate box

- I would like to be placed on your subscription list.
- I would like to be placed on your subscription list.
- Please invoice me/my company.

Mr. Ms.

FIRST NAME										SURNAME									
TITLE																			
COMPANY OR COURSE																			
ADDRESS																			
CITY										POSTCODE									
WORK PHONE																			

Signature..... Date.....

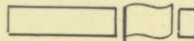

Have you used the free Reader Reply Service?

- To receive more information about the products and services advertised in this issue - place their reference flag number below.
-
-
-

How did you receive this issue of Greenkeeping Management?

- It is part of my BIGGA membership benefits.
- I am a subscriber.
- This issue was given to me by a member or subscriber.
- This issue was sent to me by post.

REF - GM 6/90

MEMBERSHIP FEES

Subscriptions for Greenkeeper membership should not be sent with the application form but will be invoiced separately.

Fees payable will be:

Course Manager/Head Greenkeeper	£36.00
Deputy Course Manager/Deputy Head Greenkeeper	£33.00
First Assistant/Assistant Greenkeeper*	£31.00
20 years of age or under	£20.00
International Members - All Greenkeeping Staff	£48.00

*The First Assistant is a post designed to recognise a third-in-charge where appropriate to the size of the club. In cases where the First Assistant is the recognised Deputy, the Deputy Course Manager/Deputy Head Greenkeeper subscription rate should apply.

Associate/Company Membership £50.00

Applicants for Associate/Company Membership should enclose a cheque made payable to BIGGA.

For details of Corporate Membership (10 or more) please contact Headquarters.

Over 5,500 subscribers are now receiving Greenkeeping Management.

They are the most knowledgeable readers in the industry.

Are you one of them?

If you are missing out **DON'T** subscribe today.

Return the pre paid reply card or Telephone 091 496 0003 or Fax 091 496 0004

EXCLUSIVE

OFFICIAL BIGGA MERCHANDISE

for the professional greenkeeper

BIGGA/GLENMUIR 1990 CLASSIC RANGE

BIGGA have teamed up with Glenmuir to produce this classic range of Glenmuir Knitwear with the BIGGA logo.

The complete range, offered in 100% machine washable lambswool, is now available exclusively to BIGGA members.

SWEATERS

- The Glenmuir Sweater is well known throughout the world as a high quality sports sweater. Its secret lies in the combination of today's technology and top quality 100% new virgin wool. It is machine washable and endorsed by the International Wool Secretariat.

- Glenmuir Sweaters come in a wide range of sizes and colours. Each sweater carries the BIGGA logo on the left breast and the Glenmuir logo on the sleeve.

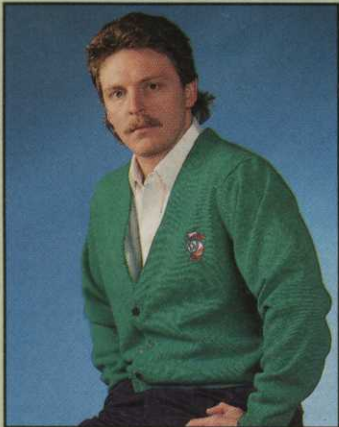

THE SPEY — Cardigan

Sizes: 36"-50" (£1.00 surcharge on 50")

Colours: Navy, Pansy, Black, Hortensia, Oxford Grey, Red, Sea Turquoise, University Green, Azure Blue

£31.95 each Order No: GM003

THE CLYDE — Sleeveless



Sizes: 36"-50" (£1.00 surcharge on 50")

Colours: Navy, Black, Hortensia, Claret, Royal, Red, Sea Turquoise, White, Blue Mist, University Green, Azure Blue, Buttermilk

£23.95 each Order No: GM002



THE FORTH — V-Neck

Sizes: 36"-50" (£1.00 surcharge on 50")

Colours: Navy, Pansy, Black, Hortensia, Claret, Oxford Grey, Royal, Red, Light Grey, Sea Turquoise, Pink, White, Blue Mist, Natural, Bottle, Mikado, Toffee, University Green, Azure Blue, Buttermilk

£25.95 each Order No: GM001



THE MOFFAT — Short Sleeved Shirt

The Glenmuir sports shirt, designed in Scotland, is available in a range of colours and can be worn with or without a tie. It is manufactured from 60% cotton/40% polyester.

Sizes: XS-XXL (36"-50")

Colours: Light Yellow, White, Burgundy, Jade, Pale Blue, Navy, Black, Stone, Peach, Candy, Ferrari Red, Bermuda Blue, Peppermint, Sky Blue, Oxford Grey, Ascot Blue

£13.50 each Order No: GM004

THE MULL — Short Sleeved Shirt



Made from 100% Cotton Piquet.

Sizes: XS-XXL (36"-50")

Colours: Candy, Navy, Jade, White, Brilliant Blue, Peppermint, Ferrari Red, Peach, Sky Blue, Light Yellow

£14.50 each Order No: GM005



TIES

- Official BIGGA ties available in five designs, custom made from 100% polyester with embroidered logo.

£4.00 each

Order Nos: (from left to right) B100, B101, B102, B103, B104

- All prices shown include VAT.

Guarantee

We have selected only quality products for the BIGGA range because we want you to be entirely satisfied with what you buy.

If for any reason you are not, return the unused item to us within 30 days of receipt and we will either supply a replacement or refund your money.

This guarantee is in addition to your statutory rights.

IF YOU ARE AN ACCESS OR BARCLAYCARD HOLDER, USE OUR 24-HOUR FASTPHONE RING

0532 560046

ORDER FORM

Send your order (no stamp needed) to:

**BIGGA OFFERS,
FREEPOST,
FARSLEY, PUDSEY, W. YORKSHIRE
LS28 5YG**

Name.....

Address.....

Town..... County.....

Postcode.....

Tel..... Date.....

Signature.....

CATALOGUE No.	PRODUCT DESCRIPTION	Colour	Size	Qty	Price

I wish to pay by Cash/Cheque/Postal Order/Credit card. I authorise you to debit my Credit Card account with the amount of £
My credit card no. is:



Single charge for any number of items

Goods Total

Handling and delivery £2.25

TOTAL

- Cheques should be made payable to Direct Marketing Ltd.

NOTE: A VAT invoice will be sent with every order

Name (as on Credit card).....

Cardholder's address.....

Signature..... Expiry Date:.....

The Stimpmeter under scrutiny

The USGA claims that once the Stimpmeter is put into widespread use, and the resulting data can be analysed and acted upon, the possibilities for improved playing conditions are endless. As long ago as the mid-70s it developed preliminary green speed charts. These were based on data from tests performed by its own agronomists on some 1500 greens in 36 American States during the 1976 and 1977 playing seasons. Here are their charts:

Speeds for Regular Membership Play		Speeds for Tournament Play
8.6"	Fast	10.6"
7.6"	Medium-Fast	9.6"
6.6"	Medium	8.6"
5.6"	Medium-Slow	7.6"
4.6"	Slow	6.6"

These speeds, the USGA stress, are presented for general information only. It is not the intention of the USGA to attempt to standardise green speeds which should remain up to the membership of each individual club e.g. Augusta National which for the Masters, which is a Club Invitational Tournament, the green speed is determined by the Club and is thought to be between 11" and 12" (the actual speed is not public knowledge!).

Nonetheless this type of information is invaluable and may well influence the green speeds aimed for in USGA-controlled events such as the US Open Championship.

What's the Stimpmeter position in Britain?

Little is heard of the Stimpmeter. We know one Golf Club where the Head Greenkeeper swears by it – George Barr at the Ham Manor Golf Club in Angmering, East Sussex – and we intend to feature George and his experience with the Stimpmeter in our next article in this series.

There is also the East Sussex National course which may use a Stimpmeter because it is reputed to have been chosen by Jill Thornhill, the Curtis Cup Captain, to help her side prepare for the defence of the Cup against the Americans at Somerset Hills, New Jersey, in July. She has been told that East Sussex National's American-style greens (fast and sloping) have the same speed as Somerset Hills!

Otherwise virtually nothing.

Even the authoritative (and welcome) Report of the Greenkeeping Panel of the Royal & Ancient GC ("The Way Forward") only once mentions the Stimpmeter (page 23 – and this is to warn our greenkeepers and their Golf Clubs) not to bow to pressure from tournament professionals to mow to "a pre-determined Stimpmeter reading – irrespective of prevailing rainfall, grass species or long term damage."

Indeed, it is disappointing not to find in this Report more mention of the Stimpmeter. Was it a missed opportunity? This Report would surely have been the ideal opportunity at least to offer an evaluation of the Stimpmeter. In its concern to warn us (and rightly) against an uncritical transplant of the "Augusta image", the Report itself seems to have been guilty of confusing the function of the Stimp-

We conclude John Nelson and Harold Swash's expert analysis of the Stimpmeter's use on both sides of the Atlantic.

meter with the results it can lead to if used uncritically.

The Stimpmeter's function is to measure green speed, and it is the only one known to us at present. Surely therefore it has a role in defining playing quality standards on golf courses (golf greens) – work which the Sports Turf Research Institute (STRI) see as "the most important research work to be undertaken" in improving the quality of our courses (page 20 of "The Way Forward" Report).

If, as is stated in the Report (page 33), we need "year round courses with firm, fast, true greens and firm, mud-free fairways", then surely we need to define what 'fast' means. Does not that mean using the Stimpmeter (at least in the absence of anything better)?

Where do we go from here?

Harold would suggest we need first some facts – a database.

We need to find out who is using the Stimpmeter, where and with what results.

We need to find out the speed of our greens for members' use and for tournaments and per type of course e.g. links,

parkland and so on. Only then would we be in an informed position to evaluate the desirability of setting speed standards for our own greens.

This means the use of the Stimpmeter – the trained use – and who better than greenkeeping staff to be trained to use it – not least in order to persuade and convince them to continue to use the Stimpmeter as "their right arm"

The 'Fudge' Factor

There will be the danger of what Harold has termed the "fudge factor" – the problem of various – unintended or intended – in the length of ball roll, when using the Stimpmeter, produced by "human error". Any two people using the Stimpmeter will handle it differently and might get different results – however slight.

This is one reason why a pattern of up to 8" is accepted by the USGA. In view, however, of what Harold believes are the relatively slower speeds on our greens, he thinks we can live with this problem – at least initially – and that it is more important to get started in training our greenkeepers to use the Stimpmeter and to assemble the database.

But he has foreseen the need to remove "human error" from Stimpmeter readings, and has invented what he has christened a "Stimpmeter Adjustment Bracket". This is fitted to the Stimpmeter and makes its use an automatic one thereby eliminating human error.

However he feels that its current value lies more with the Augusta's of this world which have already become very proficient in using the Stimpmeter and indeed work to a tolerance of no more than 3" in the pattern of ball roll (on such fast greens and fine grasses, a second ball rolling over the track of the first ball could find the grass still lying down from the roll of the first ball and roll that inch further).

The 1st to adopt the Stimpmeter in Europe

Maybe to have to follow the Americans in discovering the value of the Stimpmeter is not to everyone's liking, but not to be the first in Europe – that really would be unpalatable! Well, Harold noticed that the venue for this year's Peugeot Spanish Open Championship, and Spanish contender to host the Ryder Cup in 1993 – Club de Campo in Madrid – already uses the Stimpmeter.

The day the Championship started (26th April) The Times Newspaper, London, reported:

"Yesterday, before their scheduled double cut, the greens registered 10 on the Stimpmeter, the device used to measure their speed. Today, they should be moving into the Masters region of 11 or 12."

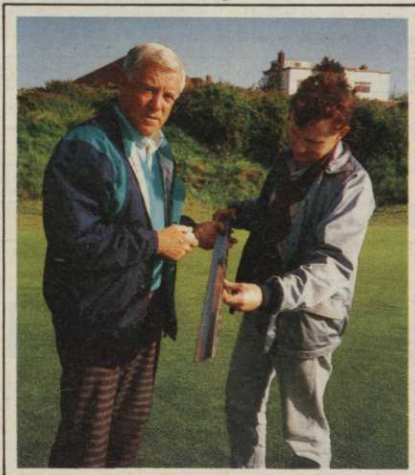

Harold Swash, left, examines his stimpmeter with an assistant.









DO YOU RECOGNIZE THIS PROBLEM?



AQUACELL 90 IRRIGATION SYSTEM

Recent long dry summers and extensive play produced and continue to produce extra problems for golf greens in the form of dry areas which could not be watered effectively or economically. At Aquacell we looked at the problem of how to hold water on these areas which normally are on some form of slope and feel that we have developed a product to repair, protect and prevent further occurrence of this problem.

The Aquacell 90 irrigation system which was designed and developed by a greenkeeper for greenkeepers offers the following benefits:

-  *Controlled watering on uneven dry areas.*
-  *No unnecessary over watering of lower areas.*
-  *Cuts down water consumption. Only used when and where necessary.*
-  *Excellent aid when seeding. When left in place, translucent material will both protect seed and promote early germination.*
-  *More efficient and economical use of wetting agent where necessary.*
-  *Use early and late in season to provide better irrigation management on greens.*
-  *Easy to use with minimum amount of labour.*
-  *Automatic protection when repairing damaged areas as no traffic can pass over when in place.*

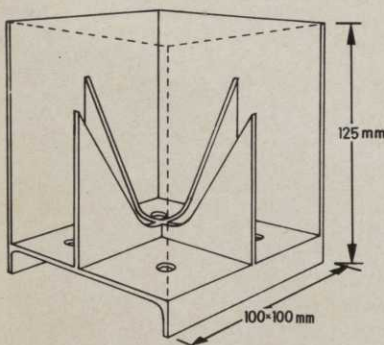
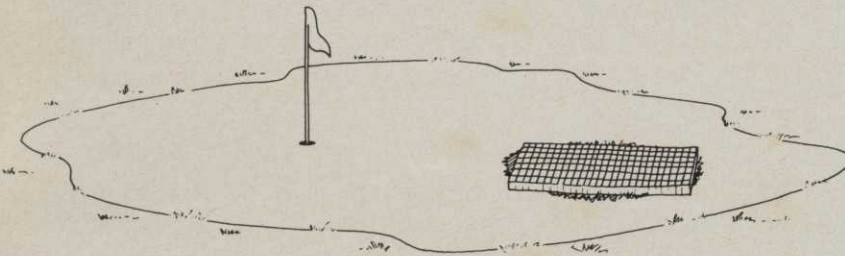

AQUACELL 90

215 Carshalton Road, Carshalton, Surrey SM5 3PZ Phone-081-643-9512