

# WHO TO LOOK OUT FOR AT THE SHOW

95

## SALTEX

SPORTS  
AMENITIES  
LANDSCAPING  
TRADES EXHIBITION  
5, 6, 7 SEPTEMBER 1995  
ROYAL WINDSOR RACECOURSE

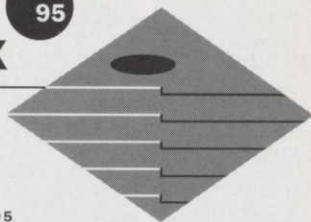

were established in 1947 as a Massey Ferguson agent and are no strangers to the needs and demands of the modern grass care professionals.

1995 saw the formation of Walter Wilder Grass and Power together with the backing of Massey Ferguson, Iseki and Richard Long Engineering.

New Machinery on display includes: \*GT 5000 Fine cut gang flail mower – perfect for sports grounds, parks and other amenity operations. The first real alternative to the cylinder mower.

**Turf Machinery Ltd** – stand O1 – Spare Parts & Engines – Top quality replacements parts and engines for your turf and grass machinery – Toro – Jacobsen – Cushman Ryan – Ransomes etc.

New Machinery Sales – Maruyama – Brush Cutters and Hedge Trimmers, Turfco – Top Dressers, Edgers and Turfcutters, Easyrake – Powered Dethatchers.

Contract & Hire – Contact us for your aeration and drainage requirements.

**British Overhead Irrigation** – stand M2 – British Overhead Irrigation Ltd will display a com-

prehensive range of irrigation hardware for both portable use and permanent installation including automatic controls and accessories. Most of the equipment can be seen operating on the demonstration area and experienced staff will be hand to discuss any irrigation matters of interest to you. Demonstration area B.

**Toro** – stand W50 – is launching three new turf products for both the amenity and golf course markets on Stand No W50 at SALTEX '95. Also being announced is a new four-wheel-drive version of its popular Workman 3000 utility vehicle.

First in the new line-up is the Groundsmaster 3000-D, an out-front rotary with a totally different design which incorporates



The new Toro Groundsmaster 3000-D

many new features to deal with the demands of larger amenity and local authority operators. There are deck options, including recyclers.

Next comes the Greensmaster 3200-D, the latest model in Toro's top-selling greensmower series, which features a unique new cutting system for unrivalled quality of cut.

Completing the turf products' picture is a new Triplex mower, the Reelmaster 2300-D. Designed to give a precision cut around bunkers, greens, tees, collars and approach areas, the machine is all-new in design, engine, drive, main frame and more.

**Dixon & Holliday Ltd** – Dixon & Holliday are specialists in Knapsack brushcutters, movers and hedgetrimmers, and offer a wide range of machines ideal for golf course use. Knapsack design minimises fatigue and gives the

operator better balance. Flexible drive provides an exceptional zone of reach and enhanced safety and control. It also gives either right or left handed use.

A wide range of cutting heads is available to suit all applications from cutting grass to pruning or thinning trees of several inches thick. The D & H hoverhood offers the easy manoeuvrability of any hover mower with the added advantage of total control when cutting banks. The hedgetrimmer give the operator maximum freedom to cut without restriction while the cultivator is ideal for loosening and weeding borders, mulch and sand bunkers where its portability and ease of use give it exceptional advantages.

**John Deere** – stand V4 – offers a comprehensive range of equipment for the professional, amenity turf and golf course markets, backed by an unrivalled

# MAKE PEACE WITH YOUR GREENKEEPER...

## Order an Atterton for him this season.

He worried the life out of all the committee members and kept on complaining about sending out his cylinders for grinding.

He told everyone about the attributes of an Atterton grinder, how you can grind in-situ with the cutter unit still in the machine.

Now you can grind the cylinder separately when the machine's stripped down for maintenance.

Now there's a new model out with a relief grinding attachment and an electric drive lifting platform to get those heavy old gang units up onto the grinding table.

Now there's a bottom blade grinder that made the ideal pair and how the pair of them would enable him to keep his cutter units and the course in tip top condition.

Now they're both the best in the business and he wanted 'em bad!

We made peace with our greenkeeper – do the same and you'll see how an Atterton reduces service account costs and provides real benefits to your greenkeeper and the course!

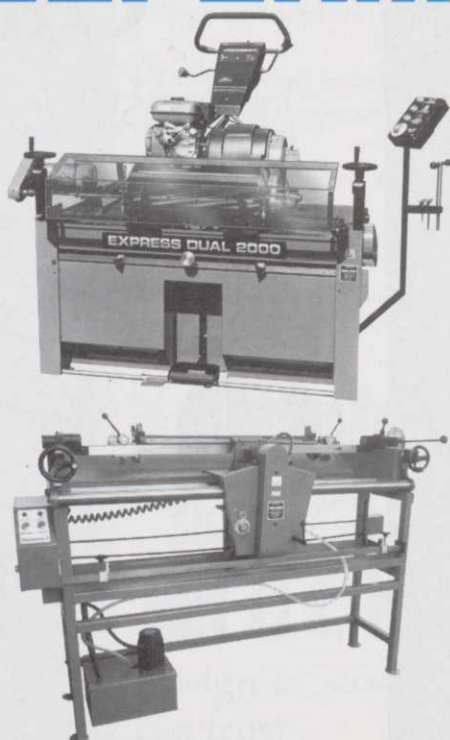

**ATTERTON & ELLIS LTD**  
Manufacturers of Fine Grinders for over 100 years  
Iron Works, Haverhill, Suffolk, CB9 8QH  
Tel: 01440 702312 Fax: 01440 712138

AD REF 7



## Our greenkeeper.

Truly way out in front, the T44 is the self-propelled gang mower. The only choice you need to make is 10" fixed or 8" floating heads with 6, 8 or 10 knives.

Ample power, advanced controls, weight transfer, four-wheel drive and differential lock combine to make this machine your perfect greenkeeper.

To proceed further in your quest for perfection, call us today for full details and to arrange a demonstration.

See us  
on Stand  
W15 at  
SALTEX



BY APPOINTMENT  
TO HER MAJESTY THE QUEEN  
MANUFACTURERS OF  
AGRICULTURAL MACHINERY  
HAYTER LIMITED  
SPELLBROOK, BISHOP'S STORTFORD, HERTS

# HAYTER

*Purpose built - Precision made*

# WHO TO LOOK OUT FOR AT THE SHOW

level of parts and dealer service support.

Over 20 models are on display at Windsor, including several machines being seen for the first time at a UK event, such as the 2653A diesel professional utility mower. This three-gang, three-wheel drive, ride-on machine was introduced in July, with new 30in cutting units available from this September.

The 455 AWS (all-wheel steer) and 415 lawn and garden tractors, launched at last year's event, have already become a popular choice with local authorities, city councils, groundscape contractors and DSOs, and can be seen equipped with side discharge mower decks and a materials collection system.

**Charterhouse Turf Machinery Ltd** on Stand C28 has some exciting developments on display. The Verti-Drain has become the Turf Manager's ally in the fight against compaction and the latest models will be on show for the time in this country.

The Turf Tidy, launched at BTME this year, makes its Saltex debut and Charterhouse Turf Machinery is promising more

new products in the coming year making the stand one which should not be missed by Grounds Managers and Greenkeepers.

Managing Director David Jenkins and his team look forward to meeting established and new customers.

**Tildenet** – stand M16 – is launching an exciting new scratch card promotion at Saltex in September. This follows the enormous success of the company's "Win a holiday in Barbados" promotion at the British Growers Look Ahead Exhibition last January at the NEC, won by Mark Floyd from Broadhouse Farm Nursery in the West Midlands.

Tildenet will be exhibiting their extensive range of products, specifically designed to assist Groundsmen and Greenkeepers, including their new range of germination sheets.

**Sports Ground Irrigation Co.**, Sales will be at Pavilion A9/10 exhibiting the full Hunter range from the new PSC 6/9/12/16 Station controllers and the HPV 1" Solenoid valves to the complete series of sprinklers.

## SALTEX

95

SPORTS  
AMENITIES  
LANDSCAPING  
TRADES EXHIBITION  
5, 6, 7 SEPTEMBER 1995  
ROYAL WINDSOR RACECOURSE

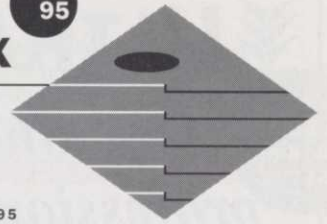

The Hunter Sprinklers range from the PS-Type/PGM/PGP Garden/Shrub series with the new 1/2" triple swing joints to the very popular industrial I-Series of which Hunter offers seven different types to suit any application.

Hunters Golf Series offer you the G550/P/Circle, the G600 F/Circle and G650 1"/Circle & G700 F/Circle, with the choice of the same type of sprinklers in the new V.I.H series.

Hunters Bowling Green Series the G750 & V.I.H. G756 gives the same choice.

Sports Ground Irrigation Sales offers associated products.

The CIC Controller has remote facilities for golf course irrigation and shortly we will be adding the PC operated controller.

**Rigby Taylor** – Stand M1 – Yet more interesting new ideas from Rigby Taylor for the Professional

Groundsman, Greenkeeper and Local Authority Manager. The Team that introduced RIMIDIN and BASTION bring you more new products to solve problems and bring better results, along with a comprehensive range of Golf Course and Sports Equipment.

Come and talk to the company with the widest product range – come and talk to Rigby Taylor.

**Lubrication Engineers** – Stand X17/18 – has provided a lubrication service to many of the best known names in British Industry for more than 20 years.

This advanced lubrication technology is now available for use in the turf management business.

Our products are designed to deliver high performance levels. Maintenance and downtime costs are cut dramatically so you will recover the initial cost of the lubricant many times over.

## Reliable Irrigation A Pipe Dream?



If your irrigation system is working well, that's fine. If it isn't or if you are considering a system for the first time, perhaps you should be talking to Ocmis. We have a decade of experience in designing and installing automatic sprinkler systems that might just be the answer to your dreams.

Ocmis Irrigation (UK) Ltd, Martock, Somerset, TA12 6BU. Tel: 01460 241939  
Midlands Office Tel: 01789 414604 Northern Office Tel: 01924 453102  
Scotland Office Tel: 01312 202102

Suppliers of irrigation systems for sportsground, recreational, amenity and landscape areas.

- ◆ Free Initial Consultation
- ◆ Professional Planning & Design
- ◆ High Specification Products
- ◆ Programmed Installation & Project Management
- ◆ Technical Support & Maintenance

See us  
on Stand  
U20 at  
SALTEX

**Buckner**

**Hunter**

**RAIN BIRD**  
PREFERRED BY PROFESSIONALS WORLDWIDE

**OCMIS**

Design & Service you  
can trust

AD  
REF  
360

# ULTRA PLANT

See us  
on Stand  
CA18 at  
SALTEX

## Machinery for the professionals in sports ground maintenance



**The U.P.60:**  
For all round top  
dressing - it's in use  
at Murryfield today



**H.L.40 and U.P.40**  
Dual lift trailer cuts  
out double handling,  
feeding accurately  
into the fine turf top  
dresser

35 Farlough Road, Newmills, Dungannon Co. Tyrone,  
Northern Ireland. BT71 4DU  
TEL/FAX: (INT 44) 018687 47582

AD  
REF  
473

## WHO TO LOOK OUT FOR AT THE SHOW

Demonstrations will be given throughout the day.

**Grass Roots** - In a bit of a hole? Help is at hand from Grass Roots, the busy greenkeepers one-stop shop, offering competitive prices and guaranteed immediate delivery to get you through a crisis.

With over 150 clients throughout the south of England, the Wokingham-based firm can save you not only time, but money. Specialising in the golf sector, Grass Roots can supply anything from turfcare consumables, machinery sales and service to furnishings and maintenance, avoiding the need to shop around individual suppliers.

Grass Roots' selection of turf-care products offer value and choice to suit all budgets. Sourced from well-known suppliers they are happy to supply whatever brand customers are currently using. Their range includes several grades of top dressing, top quality grass seed, bunker sands, top soils, turf and tools to mention but a few. Their catalogue reads like the A-Z rang-

ing from Aggregates to Wetting agents and Work wear.

**H. Patisson & Co Ltd** - stand T17 - When looking for course furnishing you have to look no further than the new Patisson's.

From the tee to the green, Patisson's offer a wide variety of choice to suit any golf course requirement or budget.

From the tee area Patisson's wide range starts with wimple placement markers to their exclusive popular resin pear shaped and golf ball tee markers, the latter being recently re-launched that are now of a better quality. As an alternative Patisson's also offer Tee Consoles, which come complete with a sign that can show anything from the course layout or simply the yardage information. This concept also lends itself to allow advertising to be placed on the back of the sign.

The launch of Patisson's new "Royale Ball Washer" made of cast aluminium, the first 18 having been supplied to St Andrews is proving to be a great success.

## On Site with Hunter Golf

### Gear-Drives That Go The Distance

Planning a new course or upgrading your existing system? Hunter now has a complete line of reliable golf rotors that are fully compatible with all irrigation systems, and ready to perform in the toughest conditions.

Hunter's exclusive Pure Flow filtration valve handles the dirtiest water, and our proven gear-drives deliver years of quiet, trouble-free operation.

- All Models Feature**
- 80mm pop-up
  - Easy, through-the-top servicing
  - Built-in recess for yardage markers
  - Adjustable arc and full-circle
  - Check-O-Matic, Hydraulic and Electric Valve-In-Head

Authorized Hunter Golf Distributor

**Sports Ground  
Irrigation Co.**  
6, Stuart Road  
Market Harborough  
Leicestershire LE16 9PQ  
Tel: 01858 463153  
Fax: 01858 410085

*Now Available in Scotland*  
**Sports Turf Services**  
Newbridge, Midlothian EH28 8LE  
Tel: 0131 333 2345  
Fax: 0131 333 5311

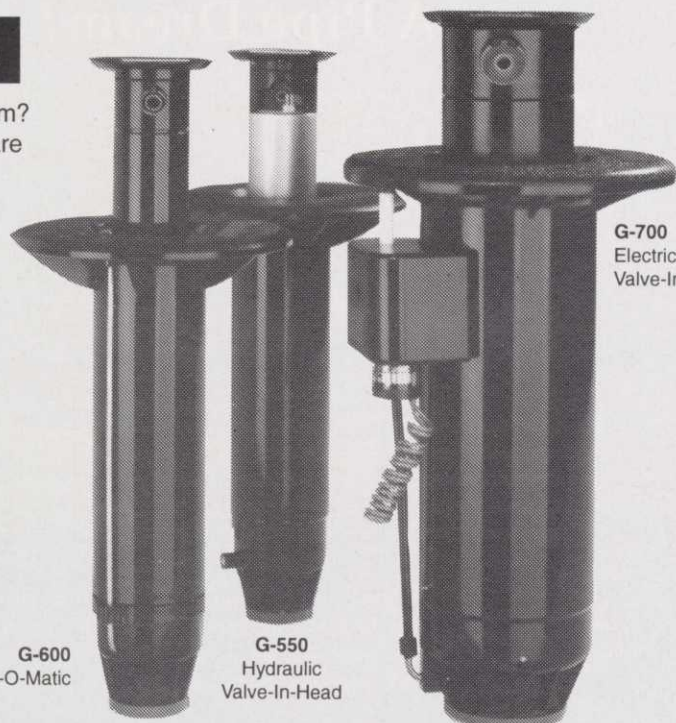

G-600  
Check-O-Matic

G-550  
Hydraulic  
Valve-In-Head

G-700  
Electric  
Valve-In-Head

# Hunter®

SEE US ON COVERED PAVILION A AT SALTEX

Europe: 26ter rue Sallier, 13100 Aix-en-Provence, France - Tel: 33-42-93-03-68 - Fax: 33-42-93-03-84

Member  
**IA**  
The Irrigation Association

AD  
REF  
397

# Buyers' Guide

The most cost-effective way of reaching readers of *Greenkeeper International*. Simply ring Bill Lynch on 0191 413 7218, Carol Dutton or Louise Lunn on 01347 838581 and ask about an alphabetical category listing: the cost starts from the equivalent of under £25 per month.

## Aerators

### AERATORS

Problems with dirty water or algae bloom? Let Otterbine clean-up your lakes and ponds.  
The world leader in water quality management.  
Available from leading irrigation companies. Full details from:

### S.G.I. Sales

6 Stuart Road,  
Market Harborough LE16 9PQ  
Tel: 01858 463153 ♦ Fax: 01858 410085

## Agronomy

### B Jamieson Golf Advisors Ltd

Bruce Jamieson formally Director of Agronomy with the PGA European Tour has now formed the above company offering expert advice on:

- ♦ Golf course maintenance
- ♦ Tournament preparation and presentation
- ♦ Machinery selection
- ♦ Budgeting
- ♦ Staff recruitment
- ♦ Soil and turf analysis

Contact: Bruce Jamieson  
10 Ashlea, Hook, Hampshire RG27 9RQ  
Telephone 01256 760870, Fax on request

### Gordon Jaaback

consulting agronomist

offers a practical and scientific approach to problem solving and an all-round service towards cost-effective golf course construction and maintenance

Introductory visit without obligation

25 Cheviot Close Tel/Fax  
Tonbridge TN9 1NH 01732 350351

### PSD AGRONOMY LTD

A COMPLETE AGRONOMIC CONSULTANCY SERVICE FOR THE GOLF CLUB and GREENKEEPER

- Contract Management of Extensions and New Courses
- Site Management and Problem Diagnosis on Existing Courses
- Technical Advice and Support all year round
- Soil and Turf Analysis



For further information contact:  
David Stansfield or John Hacker  
42 Garstang Road, Preston PR1 1NA  
Tel: (01772) 884450 Fax: 884445

## Animal Repellents

### SCUTTLE<sup>®</sup> ANIMAL REPELLENT

Up to ten weeks protection from browsing by rabbits from a single, effective spray application.

For product leaflet and the name of your nearest distributor, call

01734 510033 Read the label before you buy  
Use pesticides safely  
Scuttle contains sulphuronated  
cod liver oil  
Fax: 01734 510044

© Fine Agrochemicals Ltd., Worcester WR2 5AA

## YOU'RE ONTO A WINNER WITH GREENKEEPER INTERNATIONAL

Find three tiny £50 notes  
– win a real one, for free!

HERE WE GO with another chance to WIN £50 with Greenkeeper International!

All you have to do is take a look at this £50 note symbol. Now look through the ads in the Buyers' Guide section and spot THREE of them – they've been reduced in size, but they're there, somewhere!

Write down the names of the three ads where the £50 notes are located and send your entries on a postcard to: Note the Notes Competition, BIGGA, Aldwark Manor, Aldwark, Alne, York, North Yorkshire YO6 2NF, to be received by first post Friday August 18, 1995. The first correct entry drawn after that date will win £50. It could be YOU! Enter today – and Note the Notes!

Judges' decision is final. Not open to BIGGA staff.

£50

★ **Eagle-eyed William Cumming, Deputy Course Manager at Royal Dornoch Golf Club, Sutherland, is the lucky £50 winner of last month's competition – it could be YOU with this issue of Greenkeeper International! Get searching right now and who knows, YOU could be our next big winner!**

**AIRWAYS**  
DISCREET CONTROL  
CONSULTANCY  
ENVIRONMENTAL SERVICE & TRAINING  
*Rabbits & Moles...  
Our problem!*  
SPRINGER HOUSE • WINDMILL LANE  
KEMBLE • CIRENCESTER GLOS • GL7 6AN  
TEL: 01285 770919  
FAX: 01285 770910

## Architects

**JONATHAN GAUNT**  
B.A. (Hons.) Dip L.A.  
GOLF COURSE ARCHITECT  
From feasibility studies to complete design projects including contract supervision  
44 Stanmore Road  
London E11 3BU  
TEL: 0181 532 9181 FAX: 0181 532 9553  
Associate of the British Institute of Golf Course Architects

**David Hemstock Associates**  
Consultants on:  
• Golf Course upgrading  
• New Course development  
• Specialists in irrigation, drainage, contour and environmental surveys.  
Suite 4d, East Mill, Bridgefoot, Belper, Derbyshire DE5 1XF.  
Tel: 01773 827115 Fax: 01773 821083  
Mobile: 0850 744957

## Artificial Grass

**F3 FORCE LEISURE**  
Worting House  
Basingstoke  
Hants RG23 8PY  
Tel: 01256 811014  
• COURSE CONSTRUCTION •  
• SYNTHETIC GRASS TEES •  
• WINTER GREENS •  
• ADVENTURE GOLF •

**The Number One Choice**  
BTME  
Working for the good of the fine turf industry  
JANUARY 24-26, 1996

**VERDE SPORTS LIMITED**  
UNIT 25, COWLING MILL  
COWLING BROW  
CHORLEY  
LANCASHIRE PR6 0QG  
Tel: 01257 269983/269069  
Fax: 01257 261064  
• VERDE TEE FRAME  
Steel platform, woven grass top.  
• VERDE WINTER TEE  
Generous size, self-install kit.  
• VERDE DRIVING MATS  
Top quality - Long Life - Best Prices.  
• ARTIFICIAL GRASSES  
• DRIVING BAYS AND NETS  
For club and home use.  
TWENTY YEARS EXPERIENCE SUPPLYING THE BEST SURFACES AT COMPETITIVE PRICES.  
Please call for samples & information

## Bridges

TOTAL TIMBER ENGINEERING  
**H. L. D. LTD**  
BRIDGES  
Pedestrian and Vehicular  
REVETMENTS  
SHEET PILING  
SHELTERS  
HICKSON LEISURE DEVELOPMENTS  
NEW POTTER GRANGE ROAD, GOOLE  
NORTH HUMBERSIDE DN14 6XF  
telephone (01405) 766060 fax (01405) 768622

## Buildings

**THE GREENKEEPER'S CHOICE**  
Secure sectional steel buildings in various sizes.  
• Machinery & equipment storage  
• Fertilizer, weedkiller & seed storage  
• Workshops • Tool sheds  
• Trolley stores  
• Temporary fencing & secure enclosures  
For FREE design service, quotation, brochures and technical advice PHONE NOW  
0121 553 5723 (24hrs)  
Etwell Buildings Ltd, 204 Oldbury Road, West Bromwich, West Midlands B70 9DE. Fax: 0121 580 1172

## Cockleshells

**WASHED COCKLESHELLS**  
Delivered Nationwide  
Britain's No. 1 Supplier  
PHOENIX PATHWAYS  
Tel: 01229 468001  
Fax: 01229 468002

**COCKLESHELLS**  
always available  
Phone 0973 218144  
Best prices – guaranteed

## Chemical Disposal

**GRUNDON**  
Grundon can provide safe disposal for pesticides and herbicides and all chemical wastes. For more information on how Grundon can help with your "Duty of Care" telephone 01491 834311

## Construction

**RD JONES & SONS**  
Golf Course Construction Ltd

### DESIGN AND CONSTRUCTION SPECIALISTS

Cae Coch Farm,  
Whitford, Clwyd,  
North Wales CH8 9EP.  
Tel: 01745 561761



### CONTACT THE PROFESSIONALS

Tim Banks, Secretary, BAGCC,  
Angel Court, Dairy Yard, High Street,  
Market Harborough LE16 7NL.  
Tel: 01858 464346

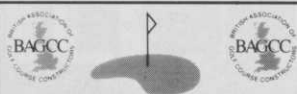

### LAND UNIT CONSTRUCTION

Hanslope, Milton Keynes, MK19 7BX  
Telephone: 01908 510414  
Fax: 01908 511056



### CONSTRUCTION AND REFURBISHMENT CONTRACTOR

For all your design and construction requirements

47A Iona Street, Edinburgh EH6 8SR  
Tel: 0131 555 1799 Fax: 0131 555 3271



ASHWELLS ROAD, BENTLEY  
BRENTWOOD, ESSEX CM15 9SR

TEL: (01277) 373720  
FAX: (01277) 374834



### C.J. Collins Construction

Golf Course Contractors



Burgess Hill, West Sussex  
Tel: 01444 242993  
Fax: 01444 247318

### Whitnell Contracts Ltd

Golf Course Constructors



Woodlands, Ellis Road  
Boxted, Colchester  
Essex CO4 5RN  
Tel: (01206) 272834  
Fax: (01206) 272104  
Mobile: 0860 421074

Whitnell  
Contracts  
Ltd

### Michael Lowe & Associates



GOLF COURSE DESIGN,  
CONSTRUCTION & CONSULTANCY

Design only, complete construction or  
any stage in between, including  
Drainage.

Pro-Shop, 72 Brynau Road,  
Llandudno, Gwynedd  
Tel: (01492) 876878 Fax: (01492) 872420

### HAVE YOU FOUND THE TINY £50 NOTES YET?

Track them down and  
win a REAL £50 note!  
*Get searching!*

### Course Accessories

## BIG BUNKERS?



Then take a tip from  
Tommy Tacit and try the  
new lightweight  
**Big Bird** bunker rake.  
Large 24" braced head  
6' x 1 1/8" GRP shaft

## TACIT

TACIT MANUFACTURERS  
RUGBY, ENGLAND

Tel: 01788 568818  
Fax: 01788 537485

### BOYD GOLF COURSE ACCESSORIES

IRELAND'S LEADING GOLF  
COURSE EQUIPMENT &  
ACCESSORY MANUFACTURER

FOR MORE INFORMATION  
TEL: (01247) 271163  
FAX: (01247) 471136

### Drainage

### SLEATH & SON SPORTSTURF DRAINAGE

Full range of modern equipment providing  
UK and European service  
Contact Geoff Sleath  
Tel: (01709) 862109 Fax: (01709) 862075

### AGRIPOWER LTD.

Construction  
Drainage  
Stone Picking  
Verti-Draining

Tel: (01494) 866776



Golf Courses  
and  
Sportsfields  
★ Drainage  
★ Construction  
★ Water Mains  
★ Fin Drains  
★ Approved sand,  
gravel and pipe  
supplied

Sunnyside, Blairadam, by Kelty,  
Fife KY4 0HY  
Tel: (01383) 830217  
Fax: (01383) 831771



WHITE HORSE  
CONTRACTORS LTD  
SPORTSTURF  
OXFORD (01865) 736272

### Driving Range Equipment



Established 1896  
H. PATTISSON & CO. LTD

Suppliers of quality golf course and driving range  
equipment.

Comprehensive range of products  
from leading manufacturers.

- ★ Ball dispensers ★ Elevators ★ Ball Washers
- ★ Range Mats ★ Baskets, Balls, Tees, etc.
- ★ Course furnishings from the tee to the green.

Contact Iain Richardson - Mobile 0850 850860  
342 Selbourne Road, Luton, Beds LU4 8NU  
Tel: 01582 597262 • Fax: 01582 505241

### RANGE SERVANT UK Ltd.

A NEW UK subsidiary of  
Range Servant of Sweden AB,  
Europe's market leader for

### GOLF RANGE EQUIPMENT

Ball Dispensers, Collectors and Washers.  
Play Off Mats and Winter Tee Mats.

### AUTOMATIC TEE-UP UNIT

Phone / Fax 01442 834242  
Mobile 0585 468624  
4 Arden Close, Bovingdon HP3 0QS

### DRIVING RANGE SUPPLIES

### EASY PICKER

Europe Ltd

### GOLF DRIVING RANGE EQUIPMENT

Upgrade your practice area using the  
world's most popular range ball picker.  
Also suppliers of ball dispensers, ball  
washers, top quality range mats and  
winter tees.

Tel: 01508 528828  
Fax: 01508 520909

### Environmental Products

*For natural and  
environmental  
solutions to get  
you growing,  
contact:*

### farmura

Stone Hill, Egerton, Ashford,  
Kent TN27 9DU  
Tel: 01233 756241 Fax: 01233 756419

### Fertilisers

### Scotts

### FERTILISERS

Scotts UK Ltd  
(formerly Grace Sierra UK)  
61 Loughborough Road,  
West Bridgford, Nottingham NG2 7LA  
Tel: 0115 9455100 Fax: 0115 9455311

### Fountains

### Fountains

For all your floating fountain and  
aerator requirements, contact  
S.G.I. Sales. Ask for details of our  
large range for functional and  
decorative displays.

### S.G.I. Sales

6 Stuart Road,  
Market Harborough,  
Leics LE16 9PQ  
Tel: 01858 463153  
Fax: 01858 410085

### Golf Course Supplies

## MONEY STONE™ LTD.

### Money Stone Bunker Sand

### Pathway Walk Chips

### Root-Zone to USGA Specification

Baths Road, Longton,  
Stoke-on-Trent,  
Staffordshire ST3 2JQ

Telephone  
01782 593233

Fax: 01782 598174

**STRIKE TOP TURF BULK SUPPLIES**

Dressings, Soils & Sands  
 Top Dressings  
 Root Zones  
 Screened Soils  
 Sands HMC  
 Moneystone, etc.

Pathways  
 Wood Fibre, Coloured  
 Wood Fibre, available bagged  
 Woodchip, all grades  
 Bark, all grades  
 Cockle Shells

Tree Planting Composts  
**Keen Prices Quoted ★ Express Delivery**  
 Phone or Fax 0161 456 7109  
 Mobile: 0831 639798

**THE UK'S LEADING SUPPLIER OF MONEYSTONE BUNKER SAND**

Unbeatable range of Cheshire Quality TOP DRESSINGS

High specification ROOT ZONES

Par-link – Ultimate pathway gravel

Grass Seeds – Vast range at low prices

Delivered Nationwide in loose bulk or 25kg bags

**Tel: 01625 584571**  
**Fax: 01625 586130**

**Martins**

QUALITY • CONSISTENCY • SERVICE

**Grass Seed**

**Jubilee Seeds & Turf**

Jubilee Seeds

A wide range of Quality Grass Seed and Flora Mixtures for all situations on the Golf Course

Jubilee Villa, 3 Ness Road, Lydd, Kent TN29 9DP  
 Tel/Fax: 01797 320536

**Turf Management Systems**

for PRE-GERMINATED GRASS SEED "LIQUID SOD" SPRAY ON GRASS TOP DRESSINGS GRASS SEED FERTILISERS HERBICIDES HORTICULTURAL PRODUCTS and All Turfcare Materials

Dromenagh Farm, Sevenhills Road, Iver Heath, Bucks SL0 0PA  
 Tel: 01895 834411  
 Fax: 01895 834892

**Irrigation**

**HIGH RELIABILITY DECODERS**

Equivalent to Watermation, Wright Rain, PrimeTime, Robydome

- ◆ No switches, more reliable
- ◆ Up to 4 independent solenoids from one decoder
- ◆ Low cost address programmer
- ◆ Competitively priced

**TONICK WATERING**  
 Tel: 01903 262393 Fax: 01903 694500  
 Distributors wanted

**NORTH STAFFS IRRIGATION**

**DESIGN AND INSTALLATION BY AN INDEPENDENT, FAMILY COMPANY**

Tel: 01785 812706 or  
 Tel/Fax: 01782 395734

**IRRIGATION CONTROL**

Design • Supply • Install • Service

INSTALLATION AND SERVICE OF IMPACT AND GEAR DRIVE SPRINKLER SYSTEMS THROUGHOUT THE UK

England Scotland  
 Winsford, Cheshire Milnathort, Kinross  
 Tel: 01606 558927 Tel: 01577 863028

**IRRIGATION under CONTROL**

**A Nationwide £39 Irrigation Service**

A well designed and installed irrigation system is a vital component to a successful project. OCMIS specialise in irrigation systems for sportsground, recreational, amenity and landscape areas.

We offer comprehensive expert consultations, designs, quotations, manufacture, supply, installation and service.

OCMIS are stockists of an extensive range of quality irrigation equipment for every requirement.

Regional offices throughout the UK  
 For further information contact  
 Head Office on 01460 241939

**OCMIS**  
 Design and service you can trust

**I.L.S. Irrigation Systems & Equipment**

For all your irrigation requirements, whether a new installation or system refurbishment – contact us now for a free survey, design, and quotation.

I.L.S. Irrigation Systems & Equipment, Oundle Road, Lutton, Peterborough PE8 5ND.  
 Tel/Fax: 01832 272450

**HORTECH SYSTEMS LTD.**

**TURF IRRIGATION SPECIALISTS**

We offer full design, installation and After Sales Service

Hortech Systems Ltd, Hallgate, Holbeach, Spalding, Lincs PE12 7LG  
 Tel: 01406 426513  
 Fax: 01406 426515

**T. & G. TURF IRRIGATION SERVICES**

38 Halfpenny Lane, Knaresborough, North Yorkshire HG5 0NS  
 Tel & Fax: (01423) 864963  
 Full member of B.T.L.I.A.

**Watermation**

Manufacturers, designers and installers of

**GOLF COURSE IRRIGATION FOR 25 YEARS**

Tongham Road, Aldershot, Hants GU12 4AA

Tel: 01252 336838  
 Fax: 01252 336808

**PARA (IRRIGATION) LTD**

**TORO**

Installation Sales & Service  
 N.E. England, Yorkshire, N. Lincs, N. Derbys, N. & S. Humberside  
 Contact: EB & L Simms  
 Tel: (01765) 602175 Fax: (01765) 603488  
 Par 4, Unit 18, Camphill Close, Dallamires Lane, Ripon, N Yorks HG4 1TT

**B SERVICE**

**TORO IRRIGATION**

**BELL TURF & IRRIGATION SERVICES**

East Midlands Area  
 Installation, Sales and Service

Everton, Doncaster, DN10 5DR  
 Tel: (01777) 817410

**Automatic Watering Systems for Sports and Leisure Grounds**

• Designed • Supplied • Installed

**GLEN HEAT & IRRIGATION**  
 Pinchbeck, Spalding, Lincs.

**Gh** Tel: (01775) 722327  
 Fax: (01775) 725444

**MIDLAND IRRIGATION**

AN INDEPENDENT IRRIGATION COMPANY

2 Fairdene Way, Great Barr, Birmingham B43 5JS

Tel: 0121 358 1246  
 Fax: 0121 357 6789

DESIGN • SUPPLY  
 INSTALLATION • SERVICE

Full member of BTLIA

**HAVE YOU FOUND THE TINY £50 NOTES YET?** Track them down and win a REAL £50 note! *Get searching!*

**Making sure your Golf Irrigation system isn't a handicap.**

Head Office and Technical Support:  
 109 Chapel Road, Hesketh Bank, Preston, Lancs., PR4 6RU  
 Tel: (01772) 813571. Fax: (01772) 815885

**AQUAPLAST**  
 Putting water in its place

**Hunter**  
 The Irrigation Innovators

Full range including Valve-in-Head from

**S.G.I. Sales**

6 Stuart Road, Market Harborough, Leics LE16 9PQ  
 Tel: 01858 463153  
 Fax: 01858 410085  
**NOW YOU HAVE A CHOICE!**

**BRITISH OVERHEAD IRRIGATION LIMITED**

Tel: (01932) 788301  
 Fax: (01932) 780437

INDEPENDENT CONTRACTORS FOR GOLF COURSE IRRIGATION SYSTEMS, UPDATES AND COMPLETE PROJECTS

**BEST BUY B.O.I.L.**

EXPERIENCE – EXPERTISE  
 CARE – SERVICE  
 since 1923

Founder Member BTLIA

**Lake Construction/Liners**

**GT GROUP**

**LEAST COST WATERPROOFING OF LAKES AND RESERVOIRS**

– using lining membranes and associated geosynthetic materials.

• Comprehensive service available to owners/architects/consultants and contractors.

GT GROUP, Naggs Corner, Wiston Road, Nayland, COLCHESTER CO6 4LT  
 For technical and sales enquiries  
 Tel: (01206) 262676  
 Fax: (01206) 262998

**Liquid Fertiliser**

**NUGRO**

**OUTSTANDING RANGE OF AMENITY PRODUCTS**

LIQUID BLOOD AND BONE  
 Plant growth supplement  
 CRN Range – unique controlled release Nitrogen products.

★ PHERTILIZER – pH Control ★ STANDARD LIQUID FERT RANGE ★ IRON PRODUCTS RANGE ★ SULPHUR PRODUCTS RANGE ★ ORGANIC PRODUCT RANGE ★ TURF WETTERS

R&D Formulations, Kettlethorpe, Lincoln  
 Tel: 01522 704848 Fax: 01522 704748

**Maintenance Software**

**Qquest**

Maintenance Management Software

The perfect software to help the Greenkeeper/Groundsman control department costs. This Powerful, Easy and Affordable programme features:

Preventative & Scheduled Maintenance  
 PM and Breakdown Work Orders  
 Repair Histories • Parts Control  
 Costs Analysis • Labour Management

Optional Extras: Chemical Tracking • Expense/Budget Tracking • Purchase Order System.

**Call or Fax for a FREE Demo Disk!**

Now available in the U.K. direct from:

**WESSEX SOFTWARE SYSTEMS**  
 PO Box 11, Billingshurst West Sussex RH14 9FH  
 Phone: 01403-784864 Fax: 01403-784067

## Mower Spares

### MOWER ACCESSORIES LTD

Manufacturers of high quality lawnmower blades and cylinders. Suppliers of spares and accessories.

65 Formcett Street  
Sheffield S4

Tel: 0114 276 5825  
Fax: 0114 276 5855

## Netting



- ★ Perimeter safety netting
- ★ Padded bay dividers
- ★ Anti-dazzle nets
- ★ Chipping nets
- ★ Target range nets
- ★ Practice cages
- ★ Anti-ball plugging net
- ★ Net bay dividers

Available from all good distributors

Tildenet Ltd, Longbrook House,  
Ashton Vale Road, Bristol  
Tel: 0117 9669684  
Fax: 0117 9231251

## Peat

### Superscreened Sphagnum Peat for Golf Course Construction and Maintenance

- ★ Conforms to BS4156
- ★ Weed and Pathogen Free
- ★ Provides quick and even establishment
- ★ Excellent water retention during dry periods
- ★ Reduced risk of dry patch
- ★ Consistent quality for easy handling and mixing
- ★ Quick and reliable deliveries nationwide

Finnfibre Horticulture Ltd

Gerrard Business Centre, Worthing Road,  
East Preston, West Sussex BN16 1AW  
Tel: 01903 859555 Fax: 01903 859666

## Railway Sleepers

RAILWAY SLEEPERS  
8'6" x 10" x 5"

CROSSING TIMBERS  
12" x 6" up to 16' long  
Price quoted for number required

Tel (01233) 625121 or 620277

## Faggs Fleet

Whitfield Road,  
Ashford, Kent

## Root Zone

PHOENIX SPORTSTURF SERVICES

QUALITY ROOTZONES  
USGA Spec available

Tel: 01229 468001 Fax: 01229 468002

## Sand/Silica Sand

Drinkwater Sabey Ltd

(EBENEZER MEARS)

KINGSLEY FINE WASHED SAND  
for Tees · Greens · Bunkers  
and drainage sands and shingles

Wintersells Road, Byfleet, KT14 7AZ

01932 345616

## GRUNDON

### NOW SPREADING IN YOUR AREA

Top Dressing  
Bunker Sand  
Root Zone  
Tees Dressing  
All Aggregates  
Path Gravels  
Cockleshell

NEW HOTLINE NUMBER:

Contact Gordon  
on 01367 244078

### TOP GRADE TOP DRESSINGS

Lime free dried & washed sands  
Lime free moist & washed sands  
Bulk 24 hour delivery service

## ARNOLD

SANDS FOR INDUSTRY

Arnold Sands Ltd  
PO Box 542  
Leighton Buzzard  
Bedfordshire LU7 8FH  
Tel: (01582) 477322  
Fax: (01582) 661476

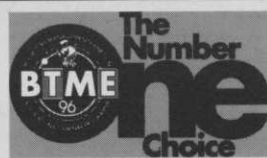

Working for the good of the fine turf industry

JANUARY 24-26, 1996

ARC Southern BUCKLAND INDUSTRIAL MINERALS

Sand and Silica Company  
COMPLETE RANGE OF  
HORTICULTURAL SANDS

Contact Lynda Jordan  
Buckland Sand & Silica Co.  
Reigate Heath, Reigate,  
Surrey RH2 9RG

Tel: (01737) 240151

## Seats

Gloster  
FINE TEAK FURNITURE

Seats, tables, chairs,  
benches,  
planters and litterbins made  
from plantation  
grown teak. Listed in  
the Good Wood Guide.  
Send for brochure.

D-Scan (UK) Ltd Concorde Road,  
Patchway, Bristol BS12 5TB  
Tel: 0117 931 5335 Fax: 0117 931 5334

## Tee Mats

GOLF MATS UK

- Suppliers of the Dunlop Winter Tee & Practice Mat
- Golf Course Furniture
- Driving Range & Practice Ground Equipment
- Flooring & Pathways

Tel: 01704 541055  
Fax: 01704 536594

## TEEMASTER

BY PRO-AM GOLF SERVICES LTD

YOUR WINTER AND PRACTICE TEE SPECIALISTS

Tel: (01446) 700130/733063

Pro-Am Golf Services Ltd.,  
Unit 20, Atlantic Trading Estate,  
Barry, South Glam., CF63 6RF

## TUFTURF

ARTIFICIAL GRASS TEE MATS,  
DRIVING RANGE MATS AND  
PUTTING SURFACES FROM  
CARPETITION LTD

14 Kaffir Road, Edgerton,  
Huddersfield HD2 2AN

Tel: (01484) 428777 Fax: (01484) 423251

## Thatch

SYMBIO GREEN CIRCLE AND BLACK LAYER TREATMENT

The biological way to:

- ✓ Degrade Thatch
- ✓ Combat Disease
- ✓ Increase Root Depth
- ✓ Reduce Fertiliser Needs
- ✓ Degrade Black Layer

Tel: 0181 669 0011 or Scotland: 0131 663 6617  
Ireland: 01266 654089 East Anglia: 01787 269292  
Wales/South West: 01202 537777

## Top Dressings

### Jubilee Seeds & Turf

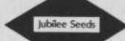

"Greentop" the New Range of  
Organic Based Topdressings,  
Turf Humus, 50/50 Coarse,  
Fine Turf Dressing

Jubilee Villa, 3 Ness Road, Lydd,  
Kent TN29 9DP  
Tel/Fax: 01797 320536

STERILISED TOP DRESSINGS from £18 per ton

PHOENIX SPORTSTURF

Tel: 01229 468001 Fax: 01229 468002

## Tree Planting

Eastcote Nurseries (Solihull) Ltd

- ★ Tree Spade hire
- ★ Tree moving
- ★ Semi mature trees

Nationwide service  
Hampton Road, Barston, Solihull,  
West Midlands B92 0JL

Tel: 01675 442033  
Fax: 01675 442324

Tree Planting Service  
Large Grants Available

Eamonn Wall & Co.  
Woodland Design and Management  
22 West Burnside, Dollar  
Tel: 01259 743212

## Turf

Q Lawns

On cue for quality and on cue for quantity

- ★ A full irrigation system complements the growing and harvesting.
- ★ Natural fertility for vigorous root growth ensuring hard wearing.
- ★ Naturally free from stone which level lying land.

Growers of Quality Turf

Weasenham Farms Company Limited  
Corkway Drive, Hockwold,  
Thetford, Norfolk IP26 4JR  
Mobile: 0585 277695  
Office: 01842 828266 Fax: 01842 827911



SOVEREIGN TURF

Growers of consistent quality turf in either big or small rolls for landscapers, amenity users and golf courses

Tel: 01728 688 984  
Fax: 01728 688 949

Fir Tree Farm, Blaxhall, Woodbridge,  
Suffolk IP12 2DX

### TURF GROWN TO YOUR SEED SPECIFICATION

or from our stock  
ALL GROWN IN STERILE COMPOST

Supplied nationwide

GREENKEEPER LTD,  
Shelford Manor, Shelford,  
Nottingham NG12 1ER

Tel/Fax: 01949 21144



## TILLERS

Growers of high quality turf supplied nationwide in standard and big rolls. All turf grown on sandy, stone-free soil.

For more information, contact  
Tim Fell at:

Tillers Turf Company Ltd  
Castlethorpe, Brigg,  
South Humberside DN20 9LG

Tel: 01652 650555  
Fax: 01652 650064

## Tip Top Turf.

Seed grown turf available in one sq yd or large 25 sq yd rolls with laying machines or service available.

Tel: 01908 270701 • Fax: 01908 374889

INTURF

GROWERS AND SUPPLIERS OF HIGH QUALITY CULTIVATED TURF FOR ALL APPLICATIONS AND APPOINTED OFFICIAL TURF PRODUCERS TO WEMBLEY STADIUM

Please contact Head Office for more information:

THE INTURF GROUP

Regent Street • Pocklington • York YO4 2QN  
Telephone 01759 304101 • Fax 01759 305229





## Turf Dressings

### FEN TURF DRESSINGS LTD

for Fendress Top Dressing

- Fendress Superfine
- Economy Dressing
- Rootzone Mixes
- Screened Fensoil • Screened Peat
- Screened Loam • Kiln Dried Sand
- Bunker Sands



Tel: (01858) 464346/433003  
Fax: (01858) 434734

## Vertidrain Hire

### MIDLAND TURF AERATING SERVICE

- ★ Verti-Draining ★ Hollow Coring with Ryan GA30
  - ★ Core Collector
  - ★ Top Dresser
  - ★ Tractor Hire
  - ★ Competitive prices
  - ★ Professional nationwide service.
- Tel/Fax: 01922 417567  
Mobile: 0973 478516  
Charles Frost



### VERTIDRAIN, HOLLOW CORING and SLIT DRAINAGE MACHINERY FOR HIRE

Contact: Peter Holmes, 10 Carson Road, Gainsborough, Lincs DN21 2RE  
Tel: 01427 613035



- ◆ Verti Drain Hire ◆ Hollow Coring
- ◆ Deep Spiking ◆ Tractor Hire
- ◆ Full range of Landscape Equipment

YORKSHIRE'S ONLY AGENT FOR WIEDENMANN TERRA-SPIKE

### SPEN-GROUNDCARE SERVICES

Unit 7, Valley Road, Liversedge, West Yorkshire WF15 6JY  
01924 401522 • 0836 722080

### PARKER HART CONTRACTING SPECIALISTS

- VERTI-DRAINING • HOLLOW CORING
- TOP DRESSING • SEEDING
- SAND SLITTING • SAND BANDING
- 3D DRAINAGE

Qualified and experienced staff  
Plus all your sports turf, amenity and horticultural supplies

Contact Anne Wicks (Contracts Manager) Tel: 0181 337 7791  
Fax: 0181 330 7392

### WORTH DRAINING

VERTIDRAINING and HOLLOW CORING HIRE with the RYAN G.A. 30

Contact Peter Bloodworth  
WORTH DRAINING  
Cornbecks Farm, Irnham, Grantham, Lincolnshire. Tel/Fax: 01476 550266

### Water Hazards

**"I couldn't believe my eyes!"**

"I tried every product on the market and nothing worked. With O'Clear the water went crystal clear in a matter of minutes!" - Ian Smith, Manchester, O'Clear customer.

Only O'Clear clears green pond water in **UNDER 2 HOURS**  
(Inhibits but doesn't kill blanket weed)

- Water clearance consultancy
- Professional treatment service for large ponds
- Bulk sales of O'CLEAR at trade prices

Only by mail order from  
AQUA COMPANY LTD, Dept GKSG  
Abbott House, 14a Hale Road  
Farnham, Surrey GU9 9QH

**(01252) 712307**

### AQUATIC WEED CONTROL and DESILTING

For lakes, ponds, rivers and bankside areas. Professionally qualified and experienced operators

Contact:

Waterland Management Ltd  
(01344) 421012

## Weed Killing



**WEED FREE**  
(BRACKNELL)

Professional Weed Killing & Associated Turf Services

MIKE SEATON F.Inst.G(Dip)  
Tel: (01344) 481011  
Fax: (01344) 300052  
Mobile: (0850) 300104

You're at the end of the Buyers Guide section - if you haven't found the ads with the 3 symbols in yet,

TRY AGAIN:  
IT COULD BE WORTH £50 TO YOU!



Working for the good of the fine turf industry

It's closer than you think...

**JANUARY 24-26, 1996**  
To book one of the few remaining stand spaces, call Louise Lunn TODAY on 01347 838581

# Job Shop

HND, National Diploma qualified Greenkeeper with five years practical experience, seeks responsible and challenging position in the UK and abroad. Construction offers welcomed. Have passport, will travel.

Box No JS 28/95, BIGGA, Aldwark Manor, Aldwark, Aline, York YO6 2NF

Working Course Manager/Head Greenkeeper running 27 hole complex, seeks new position. Experience in green, tee construction, drainage, irrigation, growing in, course construction, work programmes and budgetary control. City & Guilds certificates, PA2A Pesticides. Seeks position northern England or abroad.

Box No JS 29/95, BIGGA, Aldwark Manor, Aldwark, Aline, York YO6 2NF

### SEWARD TURF MAINTENANCE

CONTACT THE PROFESSIONALS  
Ten years experience using only the best 2 greens verti-drains (18 greens in 2 days)  
Half-inch tines at 2x2 spacing  
Fairway verti-drain  
Coremaster complete with collector  
Fairway overseeder

Contact Michael Seward  
York (01904) 765949 night or day

### Richard Campey

VERTIDRAIN 1.5mtr and 2.5mtr Hire  
Coremaster & Core Harvester.  
Shattermaster. Charterhouse Vreedo & Vertiseed Overseeders, Scarifiers and Topdressers. Large selection of Tractors, Mowers and Sports Turf Maintenance Machinery for sale.

For further details contact:

RJ & J Campey  
Marton, Macclesfield  
Tel: 01260 224568  
Fax: 01260 224791

### ROSS OLIVER SPORTS GROUND CONSTRUCTION AND MAINTENANCE

- VERTI-DRAIN for Greens and Sportsgrounds
  - STONE PICKING • RYAN HOLLOW TYNER
  - SAND SPREADERS • DIRECT DRILLS
- Greystones, Trebudannon, Cornwall TR8 4LP  
Tel: (01841) 540222 Fax: (01637) 881057

### Alder Root Golf Club



### VERTIDRAINING

Competitive rates and prompt service offered throughout the North West

For details contact:  
Ernie Lander on 01925 291919 or 0831 448817

### HERONFIELD HIRE (Solihull)

Vertidrain, Moore Sportsfield Over-Seeders, Verti Over-Seeder for Greens & Tees. Toro Aerators, Case Trenchers & Sportsfield Slitters etc.  
Contact: Doug or Ron Johnson  
Tel: (01564) 772597  
Fax available

### PETER MANNINGTON



Specialist Verti-Drain Contractor for the South  
For greens, tees, fairways and sportsgrounds  
Experienced operator, competitive prices and reliable service

Phone Peter on 01580 200205 or Mobile 0850 612061  
Sheepwash Farm, Church Street, Ticehurst, Wadhurst, East Sussex TN5 7DL

### BOUGHTON LOAM LTD.

For TURF DRESSINGS  
ROOT ZONE MIXES  
SCREENED TOP SOILS  
BUNKER SANDS  
HORTICULTURAL COMPOSTS

Telford Way, Kettering, Northants  
Tel: 01536 510515

HAVE YOU FOUND THE TINY £50 NOTES YET? Track them down and win a REAL £50 note! Get searching!

### Rufford

TOP-DRESS SUPPLIES

Britain's No. 1 for QUALITY • SERVICE • SHEER VALUE FOR MONEY  
Fairway House, South Stage, Broadway, Salford Quays, Manchester M5 2UQ  
Tel: 0161 877 8550 Fax: 0161 877 8554

## Tyres

### FLOTATION TURF TYRES

- ★ Wide Flat Threads ★
- ★ New & Used Custom Wheels ★
- ★ Bargain Prices ★

### ROTOTYPE LTD

Graveyard Lane, Ormskirk, Lancs  
Tel: 01695 421100 Fax: 01695 424265

# Job Shop

## Greenkeeper (33)

I have five years experience in greenkeeping.

My qualifications are: PA1, PA2 Pesticide Certificate and City & Guilds with Credits Phase 2.

I have experience in green and tee construction and experience with machinery. I am hard working and seek a challenging position within Bristol or surrounding areas. References and CV available.

Box No JS 26/95, BIGGA, Aldwark Manor, Aldwark, Alne, York YO6 2NF

Work required in South of England - Hampshire and surrounding counties.

Position: First Assistant, Deputy Head.

11 years experience, three at Deputy, experience in all aspects of greenkeeping.

Qualifications: Horticulture Phase 1 Year 1, Greenkeeping Sports Turf Management Phase 2 Years 2 and 3. Studying Turf Culture Level III NVQ. Spraying Certificate PA1, PA2.

Box No JS 27/95, BIGGA, Aldwark Manor, Aldwark, Alne, York YO6 2NF



**Remember: BIGGA now accepts credit cards - the convenient way to pay for magazine or membership subscriptions as well as to buy BIGGA merchandise. For details, call 01347 838581**

## RECRUITMENT

The Old Course Hotel Golf Resort and Spa  
The Duke's Course  
Craigtoun, St Andrews

requires a

## DEPUTY COURSE MANAGER

Applications are invited from suitably qualified and experienced persons with a proven record in greenkeeping and course management.

A comprehensive knowledge of machinery together with the ability to direct and motivate staff in the absence of the Course Manager are essential. Qualities required of applicants are ability to relate well to both peers and guests.

Please apply in writing with full CV and photograph to:

Owen Browne, Course Manager,  
The Duke's Course,  
The Old Course Hotel, Golf Resort and Spa,  
St Andrews, Fife KY16 9SP

## Classified

### Machinery For Sale

#### TURNER GROUNDS CARE TURNER GROUNDS CARE

Chester Road - Kelsall - Turporley - Cheshire - CW6 0RT  
Tel: (01829) 751499 Fax: (01829) 751531

#### SALE OF EX-DEMONSTRATION EQUIPMENT

Hayter T93 Greensmower as new .....£9,950  
Hinomoto C174 HST Compact Tractor.....£3,000  
John Deere 455 c/w 48" Deck and 346T  
Collector (400 hours).....£8,000  
John Deere 2243D Greensmower and  
Groomers.....£10,000  
John Deere 855 Compact with Turf Tyres .....  
£8,500  
BLEC SR5H Rotary Stoneraker.....£2,900  
60" Kilworth/Sovema Rotary Mower.....£1,000  
BLEC SB100 Stoneburier.....£2,900  
Robin Soil Dagger.....£3,200  
John Deere 4x2 Gator.....£3,700  
Proseed 4' 0".....£3,000

#### SALE OF USED EQUIPMENT

Huxley TR84 Gang Mowers (little used)£3,400  
Shibaura 1840 Compact Tractor 4WD.....£3,500  
Krone Rotavator new blades.....£575  
SISIS VEEMO Trailed 3 set nearly new £1,750  
Ransomes Bobcat.....£1,500  
Royer Powerscreen.....£750  
Rousseau ZA1300 Offset Flailmower.....£1,600  
Rousseau 1600x1 Offset Flailmower.....£1,750  
John Deere 1145 Front Wheels new complete...  
£60 EA  
Ransomes 24" Mower.....£400 EA  
Choice of 3 Modus T 40" Top Dressers £275 EA  
Massey Ferguson 1020 FWD Compact  
Hydrostatic (as new).....£5,750  
Huxley TR84 Gang Mowers (as new).....£2,000  
After hours contact Brian Spruce  
Tel: (01829) 740393 • Mobile: (0421) 432169

#### FRY & SON GRASS MACHINERY

Greens Gangs 5 Set Magna Trailed,  
as new .....£4975  
Ransomes 213D Triple with power  
steering.....£2695  
Ransomes 214 Hydraulic Gangs  
.....£2600  
Beaver LM508 Hydraulic set 5  
Gangs.....£4100  
SISIS Umo/3T Triple Towing  
Scarifier.....£1500  
Delivery inclusive  
All prices subject to VAT.  
**01794 340246**

#### Breakwell's

Cushman Truckster 3 wheel diesel c/w longbox  
+ core harvester.....£12,850  
Ryan Junior Turfcutter 12".....£2,500  
Richard Long 1502 Flail Collector.....£5,800  
Cushman Core Harvester.....£2,250  
Ransomes GT Champion vertigroom  
units and grass catchers.....£7,000  
Iseki SG17 ride-on mower 48" side  
discharge deck and collector.....£7,195  
Ryan Mataway vertical slicer.....From £2,500  
Ryan Turf Cutter 16" Heavy Duty...From £5,900  
Cushman TD1500 top dresser.....From £3,140  
Telephone: 0121 733 3344

#### Ransomes Magna set of five new blades thoroughly overhauled:

**£4,750 + VAT**

#### Ransomes set of hydraulic fives in excellent condition:

**£5,000 + VAT**

Contact:  
Peter Bloodworth  
Tel: (01476) 550266  
Mobile: (0860) 689827  
anytime  
Stoke Rochford Golf Club

#### Beaver LM 508' 5 Gang Hydraulic fairway mower, as new,

**£6,750 + VAT**

Contact  
Jack Brokenshire  
on 01948 710593  
for more details.

#### G E Adamson Grass Machinery

Ransomes Certes 20" new engine, cylinder and box.....£995  
Lloyds Paladin 21" 8 blade - new engine.....£995  
Sisis Auto-Turfmow - new tines.....£975  
Sisis MK2 Tno-Rotorake - new tines.....£575  
Sisis Sorrell Spiker - as new.....£250  
Sisis Mole Plough single - as new.....£255  
Iseki 320 HST 24HP 4W/D turf tyres - power loader  
- 1990 - 1500hrs. excellent condition.....£5950

Compact Tractors and Machinery  
All prices inclusive of transport but subject to VAT.  
Tel/Fax: 01995 640180

#### FOR SALE AFT Whizz Wheel Hi Lift Conveyor

Complete with sand/gravel  
hopper and sand compaction  
wheel. VGC.

**£9,000 OVNO**  
Tel: 01206 272834  
Mobile: 0850 272834

#### Soil Conditioners

#### KELPIE

NATURAL COMPOSTED  
SEAWEED SOIL CONDITIONER  
FROM STEWARTS  
TEL: 0131-663 6617  
FAX: 0131-663 0651

