

## **MSU Extension Publication Archive**

Archive copy of publication, do not use for current recommendations. Up-to-date information about many topics can be obtained from your local Extension office.

Culture and Agricultural Importance of Earthworms  
Michigan State University  
Cooperative Extension Service  
Robert C. Ball and L. L. Curry  
January 1977  
28pages

The PDF file was provided courtesy of the Michigan State University Library

**Scroll down to view the publication.**

# Culture and Agricultural Importance of Earthworms



By Robert C. Ball  
and L.L. Curry

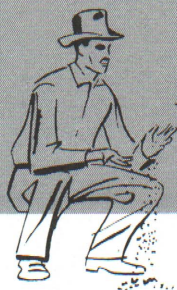

## TABLE OF CONTENTS

	Page
INTRODUCTION .....	3
GENERAL INFORMATION ABOUT EARTHWORMS .....	4
Species of Earthworms and Distribution .....	4
Feeding Habits and Response to Temperature .....	4
Reproductive Habits .....	6
Life Histories and Identification of Common Worms .....	8
COLLECTION OF EARTHWORMS .....	10
METHODS AND EQUIPMENT FOR REARING EARTH- WORMS .....	11
Containers for Earthworms .....	11
Containers for Fishing Trips .....	12
Containers for Home Storage .....	13
Containers for Large-Scale Production .....	13
Earthworm Culturing Media .....	15
Stocking and Care of Cultures .....	17
Control of Pests and Predators .....	18
Harvesting Procedure .....	18
MARKETING .....	21
Packaging .....	21
Scoured Worms .....	21
EARTHWORMS IN AGRICULTURE .....	22
Effect on Soil and Crop Production .....	22
Survival of Worms in Open Fields .....	25
Summary .....	26
LITERATURE CITED .....	26



# Culture and Agricultural Importance of Earthworms

By *ROBERT C. BALL and L. L. CURRY*

DEPARTMENT OF FISHERIES AND WILDLIFE, AND ZOOLOGY

## INTRODUCTION

Earthworms are among the best known and most common of our animals. They live in many different places and in all kinds of soil. Some species are found in lakes and streams. They are known by a variety of names—earthworm, angleworm, fishworm, night crawler, dew worm, and many others.

To anglers they are important as bait, being by far the most important fish bait used throughout the country. Because of this demand, a considerable industry in the collecting, raising and selling of earthworms has developed.

The economic value of earthworms, especially as soil conditioners, is argued a great deal. Some claim their activities in the soil have almost magical properties—while others say their presence only indicates that the soil is rich in organic matter.

Darwin (1882) showed that worms play an important part in mixing the soil. They periodically expose the lower levels of soil to the air by passing large amounts of soil through their bodies and depositing it as casts at the mouths of their burrows. This brings finely divided and intermixed materials to the surface.

Under certain conditions, they become garden pests, attacking the young plants. On the putting greens of a golf course, earthworms can become a major nuisance by making the surface uneven with piles of castings by their burrows.

The earthworm belongs to a large group of organisms classified as Annelids, of which there are approximately 7,000 known species. They are worldwide in distribution. Within this group are such animals as the leech, and earthworms ranging in size from only a fraction of an inch to the giant worms of Australia measuring up to 11 feet in length. Some earthworms are aquatic and live under water; all worms must have a moist environment because they have no lungs and must breathe through their skin.

The terrestrial worm can live in water for a long time if there is



enough oxygen present and the temperature is favorable. Toxic waters and sunlight will kill worms, as will soil so moist that the food contents spoil and the earth "sours." The two major requirements for earthworms are a moist soil and adequate food in terms of organic matter. In general, the richer the soil the more earthworms present. Worms are generally scarce in sandy soil. This may be due to lack of food and moisture. It also has been claimed that sand is directly injurious to them.

Information on the methods of culturing earthworms, their importance as soil conditioners, and the facts of their life history is scattered through many books and pamphlets. These facts are often highly colored with the enthusiasm of the commercial worm culturist. It is the purpose of this bulletin to compile and summarize much of this information.

## GENERAL INFORMATION ABOUT EARTHWORMS

### SPECIES OF EARTHWORMS AND DISTRIBUTION

The distribution of worms by species in Michigan is not well-known. A list (probably not complete) of worms that are used as bait and sold by bait dealers is shown in Table 1. Wallace states that 18 species have been found in Michigan. Of the worms listed in the table, two, *Pheretima hawayana* and *P. hilgendorfi*, are not native to Michigan; they have been introduced into this region.

Because of its small size, *Octolasion lacteum* is not generally used as a bait, while *Helodrilus caliginosus typica*, *H. foetidus*, and *H. C. trapezoides* are cultivated and used as bait extensively in Michigan. *Lumbricus terrestris* (the night crawler), the largest and most popular of native Michigan bait worms, is not successfully cultured commercially.

The term "hybrid worm" is often used—especially in advertising literature—to designate a cross between two species of worms. It is generally intended to give the impression that such a worm is larger, faster growing, or more active. There is little in the field of scientific literature to back the claims of "hybrid worm" sellers. Several samples of "hybrid worms" have been obtained from the market and examined in the laboratory, where they have been found to be the common red worm, *H. foetidus*.

### FEEDING HABITS AND RESPONSE TO TEMPERATURE

Worms are generally found in the top 12 to 18 inches of soil be-

TABLE 1—Scientific and common names of earthworms

Scientific name	Common name*
<i>Helodrilus catiginosus</i> .....	<u>Garden worm</u> or dug worm
<i>Helodrilus chloroticus</i> .....	<u>Garden worm</u> or dug worm
<i>Helodrilus foetidus</i> .....	<u>Red worm</u> , manure worm, fish worm, dung worm, fecal worm, English red worm, striped worm, stink worm, brandling, or apple pomace worm.
<i>Lumbricus rubellus</i> .....	<u>Leaf worm</u>
<i>Lumbricus terrestris</i> .....	<u>Night crawler</u> , dew worm, night walker, rain worm, angle worm, orchard worm, or night lion
<i>Octolasion lacteum</i> .....	<u>Garden worm</u> or dug worm
<i>Pheretima hawayana</i> .....	<u>Swamp worm</u>
<i>Pheretima hilgendorfi</i> .....	<u>Swamp worm</u>

\*Most commonly used name underlined.

cause there they find most, if not all, of their food. As organic matter is added to soil, partial decomposition by bacteria and molds begins. This decomposed matter, plus bits of undecomposed materials and considerable amounts of soil, make up the earthworm's food. The mixture is swallowed and ground up in the worm's gizzard.

This material, after it passes through the digestive tract, is deposited at the entrance of the burrow as casts or is used to line the burrow.

The earthworm's activity depends directly on the temperature and moisture content of the soil. After the frost has left the ground in the spring, the worms become active. During the night they are often found extended from their burrows, feeding or in the act of copulation. The posterior end of the worm is usually in the burrow, making a rapid retreat possible when the worm is disturbed.

As the season advances and the soil dries out, the worms migrate into the deeper layers where the moisture content is more suitable for their existence. During late summer, when the soil may become very dry to quite a depth, the worms react by coiling into an inactive, tight ball until moisture is restored.

During the warm days of fall, the worms again are found quite close to the surface. But as winter advances, they once more migrate deeper into the soil, to a depth of several feet. There, below the frost line, they congregate in large numbers, and there they remain until the ground thaws and warms in the spring.



## REPRODUCTIVE HABITS

Earthworms are called hermaphroditic because each individual worm contains both male and female sex organs. However, self-fertilization, or the fertilization of the eggs by the same individual, does not occur. During the warm nights of spring and early summer, earthworms come to the surface to feed and mate. When two worms come in contact with each other, they bring their ventral sides together, heads facing in opposite directions and bodies overlapping to about one-third or one-fourth of their lengths.

A band is formed about the clitellar region (Fig. 1) by the glands which secrete large quantities of a viscous mucus. This band serves to hold the two worms together during the act of copulation. Each

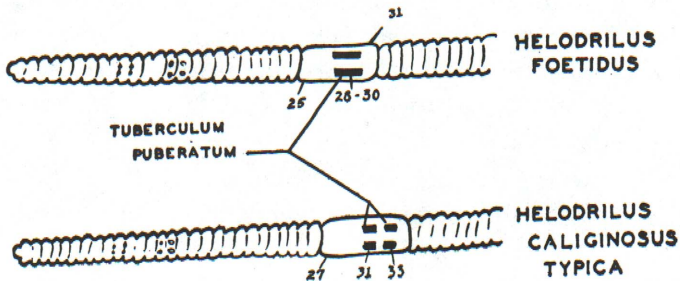
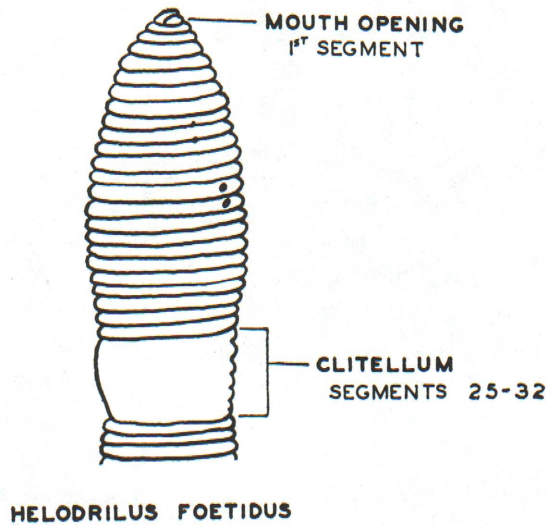

Fig. 1. Two species of earthworms, showing structures used in identification of species common in Michigan. Small numbers refer to segments.



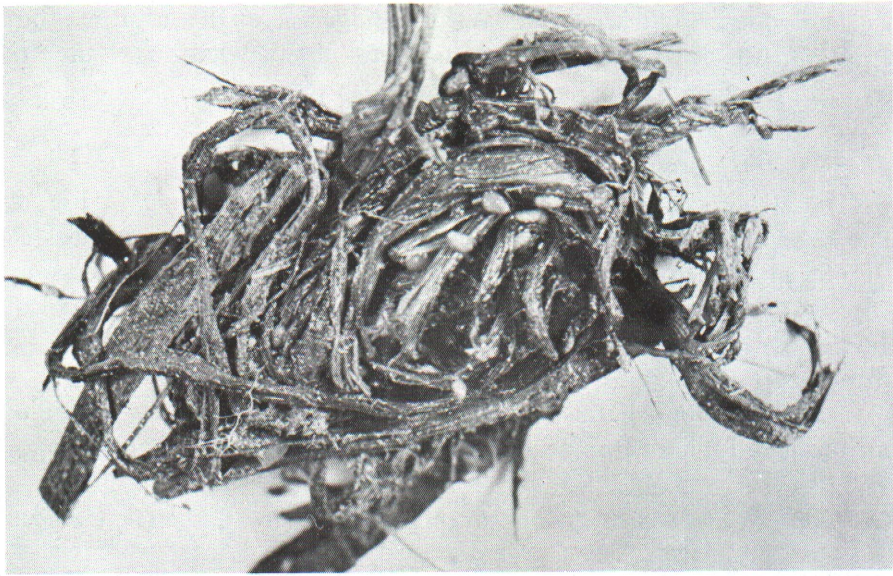

Fig. 2. Earthworm capsules deposited throughout cornstalk compost.

worm acts as an individual male, secreting the seminal fluid which is conducted along the seminal grooves to the seminal receptacles of the other, where the sperm or male cells are stored for future use.

After the worms have separated, the horny ring of gelatinous matter that has formed in the clitellar region slips forward and is worked over the body of one worm. As this ring passes the tube leading from the oviduct, it collects a few eggs, the number depending upon the species of worm. It continues its forward progress, and when it passes the openings from the seminal receptacles, it receives stored spermatozoa. The sperm then fertilize the eggs.

The ring continues its progress until it has reached the head end of the worm where it slips off and closes up as if a draw-string had pinched together the two open ends. This is called a cocoon or egg-capsule and is light brown, lemon-shaped, and about the size of a small apple seed. Several of the capsules are shown in Fig. 2, scattered through a mat of corn stalks used as mulch.

This cocoon contains the fertilized egg or eggs along with nutritive material. Within the cocoon the eggs develop into worms which, when ready to emerge, crawl out of one end after the slime plug has dissolved. The time required for this process is between 2 and 3 weeks. Size and shape of cocoons and the number of eggs vary with the different species.



The young, small worms have the same shape as the adult; as they grow and reach sexual maturity, the clitellum develops near the anterior third of the body.

#### LIFE HISTORIES AND IDENTIFICATIONS OF COMMON WORMS

The structures used to identify earthworms are shown in Fig. 1. The key used in the separation of common species is given in Table 2.

The red worm (*Helodrilus foetidus*) is the worm most successfully raised for sale. The egg-capsule is lemon-shaped, about the size of the head of a kitchen match, and greenish-yellow in color. At 70° F., an egg-capsule containing two to four eggs is produced about every 5 days. The young hatch in about 22 days. At 75° F., egg-capsules are produced more often and hatch in a shorter length of time.

TABLE 2—Key for identifying earthworms commonly sold for bait in Michigan

Location of clitellum	Species of worm
Clitellum begins on segment 14.....	<i>Pheretima</i> spp.
Clitellum begins on segment 25; ventral side of clitellum has a pair of small protruding ridges ( <i>tubercula pubertates</i> ) on segments 28 to 30.....	<i>H. foetidus</i>
Clitellum begins on segment 27; ventral side of clitellum has a pair of small protruding ridges ( <i>tubercula pubertates</i> ) from segments 31 to 33.....	<i>H. caliginosus</i>
Clitellum begins on segment 30.....	<i>O. lacteum</i>
Clitellum begins on segment 32.....	<i>L. terrestris</i>

*H. foetidus* reaches minimum angling length in 3 to 3½ months after hatching, and matures in 3½ to 4 months. Its mature length is about 2½ inches. Olson (1928) reported this species may reach a length of 5.9 inches. Although this species is perhaps the most commonly sold worm for fishing, there is some doubt that fish will take it as readily as other species. Hutchens (1947) suggested that it not be used to feed aquarium fish because of the strong-smelling body fluid which apparently causes digestive disturbances in the fish. Many tropical fish will refuse to eat this species.

*Helodrilus caliginosus*, the garden worm, is a common species sold in Michigan as bait. The egg-capsule is lemon-shaped and greenish-yellow in color. Egg-capsules are produced on the average of every 8 days and have an average of two embryos per capsule. The incubation period ranges from 50 to 68 days, depending on temperature.

About 5 months after hatching, the worms reach a length of 2 inches. They mature between the ages of 6 and 7 months, having reached an average length of 3½ inches. Some individuals of this species attain a maximum length of 8 inches.

*Lumbricus terrestris*, the common night crawler, is the largest Michigan earthworm. It produces a large, lemon-shaped, light yellow capsule. Egg-capsules are laid on the average of every 8 days and require an incubation period ranging from 61 to 80 days. There is one embryo in each capsule. Three months after hatching, the worms reach a minimum length of 2 inches. Within 5½ to 6 months, the worms have matured at an approximate length of 5 inches, but a maximum length of 10 inches may be attained.

This species is one of the most important bait worms. It brings a premium price and in late summer is often not readily available from bait supply houses. Bait dealers collect much of their supply in the spring season when these large worms are on the surface of the ground. The supply is held in cool rooms (50-60° F.) until sold.

In some areas, the chief source of these worms is from golf courses where bait dealers have leased the rights to collect them. Good sod, moisture, and abundant grass clippings apparently favor the night crawler, and they become so abundant on some courses as to be a real nuisance.

The night crawler does not do well in cultures, and, to the best of our knowledge, all of this species offered for sale are taken from natural habitats.

*Pheretima hawayana*, an exotic species in Michigan, produces a round, reddish-brown capsule containing one embryo. Adults measure 4 to 5 inches in length at maturity. This and the following species are native to India and apparently have been introduced into this country on plant imports. Their range in the state is not well known, although they have been found in several widely separated areas.

*Pheretima hilgendorfi*, another exotic swamp worm, produces egg-capsules that have the same characteristics as *P. hawayana*. Each contains one embryo. The incubation period (Stinauer, 1951) varies from 244 to 264 days. Two months after hatching, the worms attain minimum length of 2 inches. They mature 3½ to 4 months after hatching, with an average length of 4 inches. Specimens as long as 9 inches have been collected in Michigan.

These two species of worms grow nearly as large as the night



crawler but do not have the latter's flattened "tail". They are extremely active worms and appear to withstand heat and unfavorable conditions much better than do the other worms sold for bait.

Little is known of their requirements for growth and reproduction. Most of those reported in Michigan have been from very moist, rich soils, usually near lakes.

These species command a premium price as bait and could be a very profitable item if methods of culturing them in large numbers could be worked out.

## COLLECTION OF EARTHWORMS

Methods used in the collection of earthworms vary from the garden spade to the electric shocker, often depending on the season of the year and the whim of the collector. Generally, late spring and early summer are the best times to obtain them because they are then reproducing and the ground is sufficiently moist to entice them to move. During the late summer the ground is too dry; while in the fall, winter, and early spring, the temperature is too low for them to be active.

A simple method of collecting worms is to use a garden spade to dig in any likely spots—the garden area in the yard and around out-houses, manure piles, compost heaps, or any locality that furnishes the three prime conditions for growth and reproduction. These are: (1) rich organic soil with proper texture, (2) proper moisture, and (3) proper temperature.

During the period of activity in late spring, it is also possible to collect worms by merely lifting boards, stones, logs, and the like. Many worms can be collected in a very short time with little effort if the proper conditions are present.

Another common method is the use of a light on warm, moist nights during the spring or summer. Flashlight collecting can be very successful on frequently watered ground if the soil is rich in organic material and the grass is not too long. An excellent place to obtain a good catch is on the green of a golf course.

One can obtain "night crawlers" in his own backyard if the area is watered earlier in the evening. Best results are obtained with a red or dim white light; bright white or blue light will cause the worms to retreat into their burrows.

The processes of "fiddling" and "hammering" are often recommended for obtaining worms. In the former method, a stake is driven

into the ground where worms might be expected and a thin board drawn back and forth over the end of the stake. Vibrations caused by this motion will bring the earthworms to the surface. In the latter method, the stake or ground is hammered or tapped, thus causing the worms to rise to the surface to escape the disturbance. It has been reported that sawing a tree trunk will have the same effect as the "fiddling" procedure.

Electric shockers, with electrodes consisting of rods driven into the ground several feet apart, are also used. The current, passing through the ground from electrode to electrode, causes the worms to surface. This method, using house current, is potentially very dangerous and is not recommended unless the operator takes precautions to prevent injury by electrical shock.

Methods of obtaining worms by using chemical solutions on the soil have been proposed, but little is known about their general effectiveness or about their effect on the worms or the soil.

## **METHODS AND EQUIPMENT FOR REARING EARTHWORMS**

Methods of culturing earthworms vary from the simplest, such as keeping an area moist or supplying food, to the complex "assembly-line" methods used by some commercial producers.

An area receiving kitchen wastes or sewage offers a choice habitat for worms. Swingle and Sturkie (1944) mention the use of such an area but recognize its limitations due to the sour odor which may bother people. Where this drainage occurs, a few boards placed flat on the ground at random will protect the worms. When worms are wanted, merely pick up a board and collect the necessary amount. No other care is needed.

Perhaps one of the most satisfactory methods of raising enough worms for one's own use is to establish a compost pile. This can be made up of yard clippings, garden plants and weeds, table scraps, and soil. If such a compost pile is kept moist and additions of the above materials are made at intervals, a supply of worms to meet the needs of a fisherman during the summer season will be at hand. Material from such a compost pile is rich in organic matter and is valuable for flowerbeds and gardens (Fig. 3).

### **CONTAINERS FOR EARTHWORMS**

The type, size, and location of containers and season of the year will determine the amount of care required to keep worms alive for any





New York Zoological Society Photo

**Fig. 3.** The material from earthworm culture boxes and compost beds makes excellent soil for flower beds.

definite period of time. Cultures in indoor containers require more care than the outdoor shelter. Such factors as moisture, temperature, food, and light will have to be kept just right for successful worm storage. Worms in their natural environment seek the above factors by movement through the soil.

If worms are to be used during the summer, storage outside is probably best, and the proper amount of food can be supplied with little effort. Occasional watering will be required to keep the soil moist enough for lively, healthy worms. However, if worms will be needed during the winter, or if a stock for summer sale is to be developed, a heated building will be necessary.

### **Containers for fishing trips**

A satisfactory container for storing worms for several days or during extended fishing trips can be made from a metal box having a hinged top and lined with sheet cork coated with paraffin wax. The box should be enclosed in a heavy canvas bag. By keeping the canvas cover moist, worms placed in sphagnum moss in such a container will keep alive and active for several days in hot weather.

A less expensive container can be made from a cloth sugar sack filled with moistened sphagnum. The sack should be moistened whenever needed during the day to prevent the worms from drying out.



## Containers for home storage

Storage containers for holding worms for an entire fishing season may be made from wooden buckets, earthenware crocks, tightly constructed boxes, old bathtubs, old boats, or lug boxes. Metal containers should be treated on the inner surface with hot asphalt or rust-resisting paint to prevent corrosion and also to protect worms from the rusted metal. Such containers can be kept in a garage or basement where it is cool, or outdoors in a shady place.

If stored outside, sink the container in the ground with only the top protruding a few inches, or cover with sod or sacks filled with straw and keep wet. Provide drainage in the bottom of all boxes, and cover these holes and other cracks with screen to prevent the worms' escape.

The number of worms to be stored determines the size of the container. A bed of compost 8 feet long, 4 feet wide, and 2 feet deep can support a population of more than 50,000 earthworms. A box 6 by 14 by 20 inches can hold 500 to 1,500 worms; while a wash tub will hold 1,500 to 3,000 large size worms or about 4,000 the size of *H. foetidus*, the common red worm.

## Containers for large-scale production

Equipment for the commercial culture of earthworms differs in many respects from that for the fisherman whose needs for bait are limited. Production methods for raising large numbers of worms are of three general types: box cultures in which the culture media are in small, easily handled units; large bin-type containers; and open-field raising with food and moisture added to the natural environment and collecting done by plowing or digging.

A practical container can be made from a fruit lug—a wooden box 14 inches wide, 20 inches long, and 6 inches deep. This size is convenient and easy to handle (Fig. 4). For intensive propagation where frequent handling for inspection and sorting is necessary, a box depth of 6 inches is very desirable since handling larger, heavier boxes full of soil is difficult.

Boxes used in extensive worm culture operations should be a standard size to stack easily in tiers. The boxes should have drainage holes, and these should be covered with screen to prevent loss of worms. Several lengths of lath cut to fit the inside bottom of the box will prevent sagging and also keep the culture medium from sticking when boxes are emptied. A strip of lath fastened over the nails on

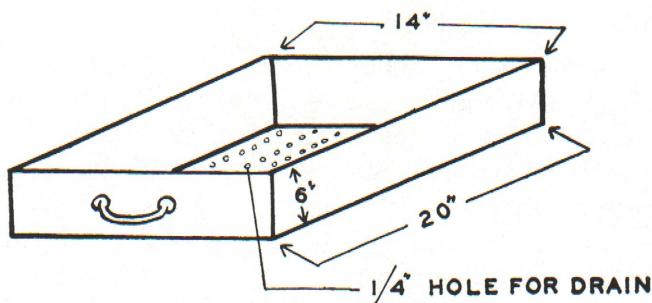

SINGLE UNIT WORM BOX

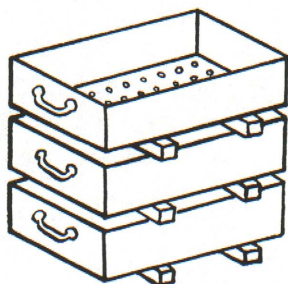

STACKED UNITS-SHOWING 2 X 2 DIVIDERS

Fig. 4. Details of construction of worm boxes and method of stacking.

the bottom of the box will prevent them from rusting out of the boards.

Two pieces of  $\frac{3}{4}$ - by 1-inch stock, one nailed on each end of the box, will serve as handles. If boxes are to be used for intensive breeding containers, data cards should be placed at one end of each container so that information regarding feeding, moisture, culturing dates, and so forth may be recorded.

Dividers can be made from 2- by 2-inch boards cut to the length of each box (Fig. 4) and nailed across the bottom at each end to hold them apart, thus allowing ventilation and space for adding water. Several boxes may be stacked, using dividers between each pair. If culture boxes are off the ground and the tops are covered with burlap, the worms are not so apt to leave the container.

A wooden base that will raise the tier of boxes 2 to 4 inches off the floor will prevent worms from escaping and make handling and cleaning easier.



The bin-type container differs from the boxes described above in that it is larger and is not portable. It should be located in a shady, well-drained spot in the yard or garden, or it may be placed in the garage or basement. Wood, concrete, or concrete blocks may be used to build a worm bin.

A single unit 5 feet long, 3 feet wide, and 2 feet deep is a good size. The unit should be tight and, if outdoors, provided with a tight top to prevent snow and rain, as well as animals, from entering. Any wood used should be treated to prevent rotting. The top should be constructed so that it can be removed for ventilation during clear weather. Screened openings in the sides of the bin will provide ventilation when the top cannot be removed.

A common type of outdoor worm bin used by Michigan commercial worm culturists is built 2 to 3 feet above the ground by placing boards against a framework of posts. Such a bin can be of any dimensions, with a convenient size being 4 feet by 8 feet by 2 feet high. This size of bin will support 50,000 worms. Where greater capacity is needed, it is better to build more bins than to enlarge this size.

Bins can be built either with wooden sides and ends held upright by posts (steel fence posts serve well) or with two sides and one end formed of concrete blocks (Fig. 5).

With either type, one end must be removable so that compost and worms can be removed. Where worms are fed for rapid growth, the resulting compost is rich in organic matter. This is excellent for flower beds and, in some areas, has a high sale value.

All bins where worms are reared and harvested on an intensive basis should have a firm bottom. A half-inch layer of gravel on the ground will give essential drainage and, over this, boards running the length of the bin will provide a firm base to ease unloading the contents. This will also prevent moles and mice from tunneling into the culture. A top to protect the bin from excess rain and heat is necessary in most locations.

#### EARTHWORM CULTURING MEDIA

Any one of various combinations of soil and organic matter will serve as a medium in which to raise earthworms. If worms are to be held for short periods, the medium in which they are kept does not need to contain food but can serve primarily to keep them moist and clean. If the worms are expected to maintain themselves for an extended period or to grow and reproduce, however, the medium must contain adequate food.



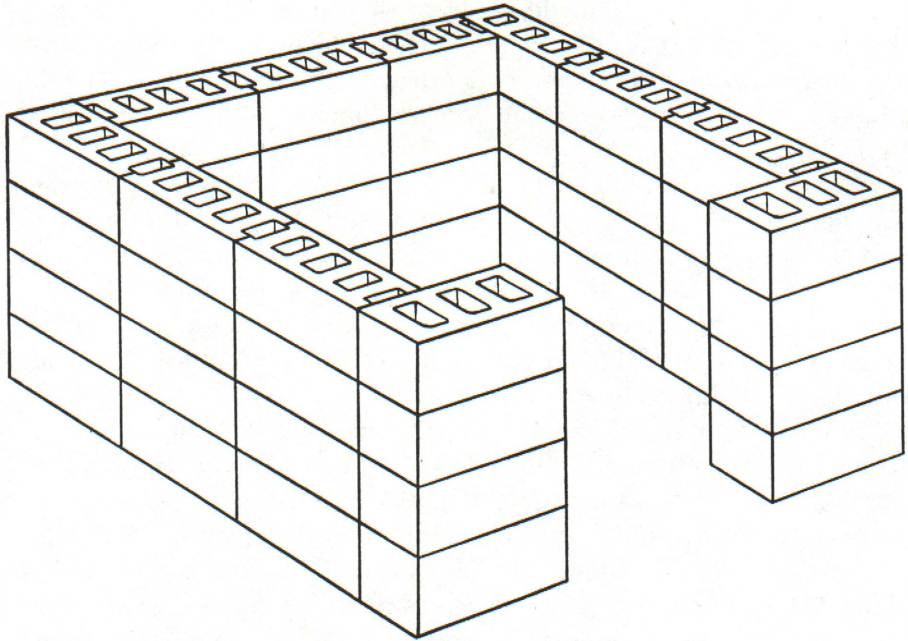

Fig. 5. Concrete block worm bin.

The soil medium for either indoor or outdoor beds can be made up from any of several sources of organic material. The mixture should be about one-third rich black soil, with the remainder any combination of the following materials: peat moss, manure, leaf mold, sod, black (decayed) sawdust, straw, hay, or leaves.

In filling the smaller culture boxes, the owner should cover the bottom with a layer of peat moss, burlap, or several strips of thin board to prevent soil from sticking to the bottom of the box and to aid drainage and aeration.

Since the growth of earthworms depends a lot on available food, it is necessary to add to the soil mixture other foods such as kitchen scraps, fats, cornmeal, or chick starter. For smaller indoor cultures, these foods should be thoroughly mixed with the other materials before the boxes are filled or when the worms are harvested and the soil containing egg-capsules is returned to the boxes.

For outdoor worm beds, it is possible to use larger material, such as grass clippings, garden vegetable wastes, etc. In addition, garbage and kitchen fats may be added to the bed. It is important to note that when organic matter such as garbage is added, it should be covered over to avoid spoilage and "souring" of the worm bed.

Worms may be stored for short periods in a mulch of straw or leaves, a combination of mulch and soil, or in peat moss (sphagnum). Soil with high sand content should be avoided since it is generally considered (although experimental evidence is scarce) that sand harms the digestive tract of earthworms. A porous clay loam or topsoil from the woods may be used. A soil mixture of screened topsoil, manure, and peat moss may be prepared. Peat moss may be secured from a greenhouse or around the margin of a bog lake. In brief, the culture medium should be a mixture of organic materials that will not pack into a soggy, dense mass.

### STOCKING AND CARE OF CULTURES

To begin the rearing of earthworms after the culture boxes have been prepared, about 400 mature worms (over 2 inches) should be spread out on top of the soil in the box and allowed to work their way into it. Those that have not dug in within a few minutes should be taken off and discarded.

The worms will, within a short time, begin to produce egg-capsules; within 3 weeks, enough capsules to stock the box will have been produced. Breeder worms can then be removed and placed in a fresh box of soil. The soil mixture from which they were removed is replaced in the same box and labeled for harvesting in about 4 months.

When sufficient culture boxes have been established, each box can remain undisturbed for about 3 months, by which time the worms will have reached the reproductive stage, egg-capsules will have been deposited, and mature worms will be ready for sale. Under conditions where food and water are adequate and the temperature has been held near 70° F., the worms should be about 2 inches long. This is about the minimum size that is acceptable as bait. If larger worms are desired, a longer period must pass before they are harvested.

Information given here relates to the red worm (*Helodrilus foetidus*), the worm most commonly grown in box cultures. As the section on life histories of earthworms points out, this is an early-maturing and fast-growing worm. If other species are reared (for identification, see Table 3), conditions and procedures must be modified to suit their requirements. Only trial and experience will find methods best suited to the individual operation and solve the many details of worm culture.

Perhaps the most critical factor in rearing earthworms is moisture. It is very important that the cultures be kept moist at all times. To



preserve moisture in boxes, a cover of burlap should be fitted into the top. This serves to keep the box dark, to prevent rapid evaporation of moisture, and to aid in distributing the moisture evenly when the boxes are watered. Although soil should be moist at all times, it should not be soaked to the point where it becomes soggy.

Worms are quite sensitive to temperature changes; while they will tolerate high soil temperatures for short periods of time, they do best in cultures within the range of 60 to 70° F. The night crawler (*L. terrestris*) is not tolerant of higher temperatures and, when collected in the spring for sale later in the summer, should be held at about 50° F.

### CONTROL OF PESTS AND PREDATORS

Earthworm cultures also afford an ideal habitat for many undesirable pests. Those that will be attracted include rats, mice, moles, gophers, mites, ants, termites, springtails, sowbugs, snails, slugs, millipedes, centipedes, and spiders. Some will be found to be predators, while others will be merely pests of little or no importance.

Rats and mice may be controlled by placing hardware cloth over the tops and sides of culture boxes. For outdoor earthworm culture, covering pits and laying boards on the gravel bed will help keep pests out. Use of sulphur dust, pyrethrum dust, or insecticides containing rotenone will keep numbers of ants, mites, and springtails down. The culturist must not use an insecticide that is toxic to earthworms, as the whole culture may be destroyed along with the pests.

### HARVESTING PROCEDURE

When temporary containers are used to hold earthworms for several days or weeks, harvesting the worms is a simple task. The boxes are merely emptied and the worms sorted out of the soil. However, harvesting large numbers for commercial purposes requires proper equipment for efficient handling of the crop.

The proper type of table and accessories are essential. A table 30 inches high, 30 inches wide, and about 6 feet long is satisfactory. The top of the table should be covered with sheet metal having no cracks into which the worms may crawl. The metal top should extend beyond one end of the table, forming a trough with a lip about 8 inches long. (See Fig. 6.)

As the cultures are sorted, the medium is pushed into the trough and falls into a box placed below the edge of the sorting table. This

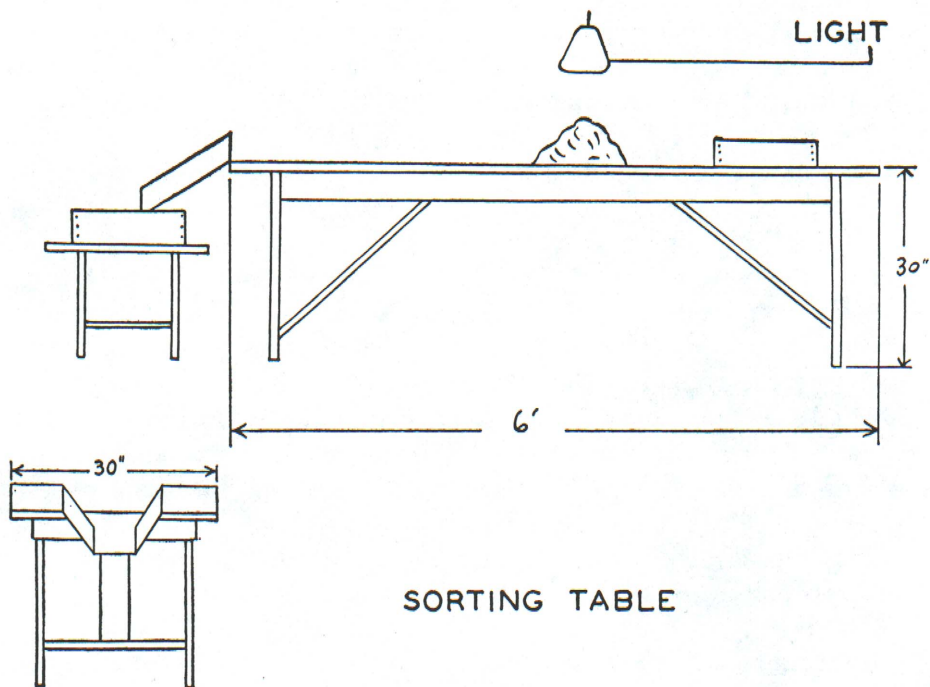

Fig. 6. Sorting table useful for handling materials from box cultures.

arrangement will eliminate much handling of the medium from culture boxes in the sorting process. One or two lights should be located about 30 inches directly above the table. Boxes should not be watered for 3 or 4 days prior to sorting.

The process of sorting the culture medium is as follows: The contents of a box are dumped upon the surface of the table and raked into a cone-shaped pile. Worms react to the light directly above the table by crawling towards the center of the pile. If the sorting process is halted for about half an hour, worms will work their way to the bottom of the pile.

The soil is now raked from the surface with the fingers so that the worms will not be injured. As the material is sorted, it is pushed through the trough to an empty culture box below. The pile is worked over until two-thirds of it is removed. The material in the box below the trough contains most of the eggs that were produced during the last 20 to 30 days, since it was the bottom soil in the original culture box.

As the worms are taken from the soil culture, they are placed in small cartons containing culture medium or peat moss. These worms



will be the ones sold or used as breeder worms by the culturist. The remaining soil is now sorted and the worms removed. This soil may be discarded, as most of the egg-capsules were deposited in the deeper soil sorted previously.

A mixture of about two-thirds new medium and food is recommended as the ratio to mix with the old soil in the new culture box. Egg-capsules in the new culture box will hatch, and new worms of salable size will be produced in the next 3 to 4 months.

Worms reared in the larger pit containers should be sorted from the medium (Fig. 7) by using a screen having four meshes per inch. The screen is nailed to the bottom of a frame having dimensions of about 18 by 24 inches. As the boards are removed from one end of the pit, the compost is removed with a shovel and small amounts are placed on the screen. The screening process may be done over a wheelbarrow or compost pile, as part of this soil will be discarded and freshly mixed medium used to furnish the necessary food material for the next culture period.

In sorting, as in the above procedure, egg-capsules will be found in the screened soil. This soil must be kept separate from the freshly mixed medium until a new culture is set up.



New York Zoological Society Photo

**Fig. 7.** Sorting screen used to remove worms from culture medium.



Production rates will be determined by number of culture boxes, number of breeder worms, temperature, food and moisture, and the condition of the culture medium. The size of worms and their growth rate will be considerably reduced if the boxes or bins become overcrowded.

### **MARKETING**

Many of the earthworms raised in Michigan are sold for fish bait. The best markets for this purpose are resort and recreational areas. Prospective worm culturists live near these areas and in or near large cities. Owners of bait shops, boat liveries, service stations, and even grocery stores in the resort areas can raise earthworms.

People interested in soil building also buy many worms; for example, gardeners, nurserymen, farmers, and orchardists are all prospective buyers. Schools having biology courses also buy worms for embryological, regenerative and other biological studies.

### **PACKAGING**

When worms are sold, whether directly to fishermen or for shipment away from the area in which they are raised, it is essential that they be properly packaged to insure arrival at their destination in good condition. The type of container used to pack bulk ice cream has been found quite satisfactory for shipment of worms and will keep them alive for several days if kept in a cool place. This container is made of heavy waxed paper and has a tight-fitting lid. It comes in several sizes and is readily available. When used for shipping, the cover should be punched in several places to insure ventilation.

Moistened peat moss is satisfactory as a packing medium because it holds moisture and does not pack down. If worms are to be in the container for a considerable period of time, food should be added each week. The amount will vary with the number of worms and the size of the container, but about 1 teaspoon of pablum, cornmeal, or chicken mash to a pint container is sufficient.

It is important not to overcrowd worms when packaging them for shipping or direct sale. About 50 worms the size of the common red worm to a half-pint package, 250 to a quart size or 500 to a gallon container will live for several days with no care other than keeping them cool.

### **SCOURED WORMS**

Tough, lively, and clean earthworms will bring a much better price



and assure the dealer of more repeated sales than will inactive worms in poor shape. The process of scouring will result in more active worms that will live longer on the hook and thus increase the possibility of catching more fish.

Isaak Walton (1653) was the first to describe the scouring method, which consists of placing worms in well-moistened sphagnum in a cool place for 3 or 4 days. The worms become transparent, tough, and quite lively. If worms are kept in sphagnum for any length of time, they should be fed once a week. The moss should be washed occasionally to prevent decay of unused food particles which will kill worms. Scouring can also be accomplished by placing the worms in a box of moist sand for 2 or 3 days.

## EARTHWORMS IN AGRICULTURE

### EFFECT ON SOIL AND CROP PRODUCTION

Only recently has there been a serious attempt to establish the role of the earthworm in agriculture. It is still the general opinion that the activities of earthworms in the soil result in the contents being mixed, aeration increased, and drainage improved. Because of this belief, some agriculturists have concluded that earthworms bring about an earlier maturing of crops, increase the yield, and even insure a vigorous, disease-and-insect-resistant plant requiring less fertilizer and water.

Experimental evidence regarding these claims is conflicting.

Hopp and Slater (1948b) state that the number of earthworms in the soil roughly parallels the productivity of that soil. In this same experiment, the authors worked organic matter and lime into the soil where the pH was low. Earthworms were planted in some of the experimental soils and crops were planted. Results showed increased growth of the various plants where earthworms were present. During this experiment, ants were observed to be working in one of the experimental soils in which no earthworms were planted. Plants grown in this soil also increased their yield.

The authors concluded that the increased yield was apparently due to improvement in the infiltration rate of the soil by the earthworms, but that ants were able to produce the same effect.

The effects of ant and worm activity on soil structure is of major importance, especially in soils low in porosity, according to Hopp and Hopkins (1946a). This experiment did not imply that earthworms

should be planted in poor soils, since they will be present and distribute themselves if the environment is suitable.

Hopp and Linder (1947) state that there is evidence of earthworms having important physical and chemical effects on the soil. However, there is little information regarding their effect on row-crop farming, since practical measures have not yet been devised for maintaining earthworms under these conditions.

Field and laboratory experiments conducted with earthworms to study their direct effect upon crop production have not substantiated the claims of their enthusiastic backers. Annual plants grown in soil containing earthworm castings, or with soil and worms in various combinations, have shown no increase in flower size or number of blooms over those grown in soil without worms.

Chadwick and Bradley (1948), using earthworms in "organic farming" experiments, found that it was necessary to have organic matter in the soil to maintain a population of worms. Their findings indicated that worms would disappear when added to an inorganic soil plot; but, when organic matter was added in the form of manure, the worms increased 25 percent. These findings agree with the results obtained by Russell (1908), and Hopp and Hopkins (1946). They found that most of the worms added to a soil without a substantial amount of organic matter die.

The importance of earthworm casts is also debatable. Lunt and Jacobson (1944) analyzed casts and unworked soils of several depths from cultivated fields and forested areas. They found that field soil contained more clay than the casts and had a higher pH and total nitrate nitrogen. The casts showed an increase in organic matter, a change in the chemical nature of soil, and a higher moisture equivalent, compared to the surrounding soil.

Lunt and Jacobson concluded that the effect of earthworms in the soil was to intimately mix plant and animal remains with the mineral soil and, apparently due to the action of their digestive system, to alter the physical and chemical nature of the soil. However, the same authors hasten to point out that where conditions are favorable to worms, they are also favorable to plant growth, and that quantitative measurement under field conditions has not yet been obtained.

Dawson (1948) found that worm activity favors the addition of organic matter to the soil. The aggregates from the worm's intestine are more stable to rain. Changes take place in the soil which result in



the liberation of simpler organic and inorganic compounds. The series of compounds liberated are important to plant growth.

Powers and Bollen (1935) were less enthusiastic about their findings regarding the analysis of worm castings. They likewise found a buildup of nitrogen and organic matter as compared to parent soil. However, worms and related micro-organisms *all* play an important part in intimately mixing organic matter and soil.

Their experimentation was carried a step further—they analyzed castings found under different kinds of trees. Here, too, they found a difference in their analysis. Besides analyzing castings, they carried on experiments with crop production and earthworm activity. They concluded that worms increased barley production, a conclusion directly opposed to that reached by some other investigators.

In one experiment in which the "hybrid" worm was employed (as contrasted to the common dug worm), plants grown in the soil having the common worm showed some improvement over those grown in the soil containing the "hybrids." Chrysanthemums grown in soil containing earthworms were just as susceptible to insects and wilt as were those grown without earthworm action.

In the latter experiment, it was found that the soil crusted less with the addition of organic matter. Analysis of the soil after the experiments showed that the various treatments with earthworms did not cause any appreciable change in the total and capillary pore space. The addition of manure in perennial plots, however, increased the total porosity of the soil. The use of the so-called "hybrid" worm for increased crop production is a controversial topic that has gained importance commercially. Chadwick and Bradley (1948) employed this so-called hybrid and wild worms to study crop production. They bluntly reported that: "Scientific research reveals that hybridization of earthworms is very difficult, if not an impossible achievement." The only available record of actual hybridization that has come to the attention of the authors of this bulletin is that reprinted in Stephenson's *Oligochaeta* (1930). It reports that Harms, a German scientist, grafted the ovaries of one species into another. A few of these hybrids hatched from the capsule, but none lived to reach sexual maturity.

The same authors compared the commercial "hybrid" worm, in regard to crop production, with the common worm, *Helodrilus (Alolobophora) caliginosus*. Taxonomically, the "hybrid" was found to be *Helodrilus (Eisenia) foetidus*, or, in some instances, *Helodrilus*

(*Eisenia*) *roseus*. Each of these is commonly found in compost heaps, manure pits, or similar decaying matter.

### SURVIVAL OF WORMS IN OPEN FIELDS

Under the variety of farming practices today, especially with the demand for a more intensive crop production, soil is often left unprotected during part of the year. Since a temperature of 32° F. is fatal to worms, there is a reduced worm population on the bare fields.

It has been found that the largest numbers of worms congregate under grass roots in sodded fields, and it has been shown that the least favorable cropping systems support a worm population only about one-tenth as great as the most favorable. The decline of the worms is not due primarily to the loss of organic matter from the soil, since the decline can be avoided with ordinary harvesting methods.

One factor which appears to influence earthworms unfavorably is sudden drops in temperature from which they have no protection. Field crops with little litter after harvesting offer small protection to worms. On the other hand, crops having much vegetative litter, or those remaining in the ground over winter, protect the worm population.

For example, of the soils investigated in Maryland, the greatest decrease in worm population occurred in soils with no crop cover and in those in which the soil was laid bare by early spring tillage. The greatest decrease took place during the first heavy freeze in the fall. However, no decrease in numbers could be found during the grain and sod phase of a 2-year rotation.

Therefore, it would seem possible to control the number of earthworms in the soil throughout the year to some extent by using certain agricultural practices.

Hopp (1948), studying the reproductive patterns of worms under sod and field conditions, concluded that the greatest weight and numbers occur during spring and fall. He found that mature worms, most plentiful in the spring, decrease in numbers as the year passes. There is a corresponding increase of younger worms in the fall.

Also, the weight per unit area decreases during the summer, reaching its lowest point during the fall. During the winter, weight steadily increases, reaching a peak in the spring.

From these investigations, it is suggested that worms adapt to lower temperatures if sufficient cover is available. In protected areas,



the ground does not freeze deeply at first, and worms in such areas become tolerant or conditioned to the cold.

A discussion on earthworms would not be complete without a word regarding the effect of commercial fertilizers on worms.

Whether worms can live in the presence of commercial fertilizers is still a point of disagreement. Both points of view have appeared in print. One school of thought believes that fertilizer is detrimental to the well-being of the earthworms, that the worms will soon leave the habitat, and that the result would be a virtual desert. Opponents hold that this material has no effect upon the worm population.

The New Jersey Agricultural Experimental Station (1951) reported that heavy applications of inorganic fertilizers and lime were not harmful to worm populations.

### SUMMARY

In all the researches carried out to date, several points are in agreement. In all cases, organic matter had to be present in the soil for the earthworms to live and without it they were not present. Secondly, worms require oxygen, and are present in only well-aerated soils. Lastly, moisture is all-important for their activity. For a population of worms to exist in the soil, the environment must furnish organic matter, moisture, and oxygen. A fourth factor may be added, that of winter coverage to protect the population from the killing frosts.

If the above conditions are met, earthworms will be present in the soil and there is no need of transplanting worms from another area, nor of buying worms to increase the population. Conditions being favorable, the population will increase in proportion to the limits of the environment. Worms can not be planted indiscriminately and be expected to build up the soil. If the worms are already present, they will take care of themselves and man need not interfere with time-consuming and costly ventures.

### LITERATURE CITED

- Allee, W. C.; M. M. Torvik, J. P. Lahr and P. L. Hollister (1930). Influence of soil reaction on earthworms. *Physio. Zoo.* 3: 164-200.
- Bear, F. E., and A. L. Prince (1951). Organic matter in New Jersey soils. *N. J. Agr. Expt. Sta. Bul.* 757. 7 pp.
- Chadwick, L. C., and Kenneth Bradley (1948). An experimental study of the effects of certain earthworms on crop production. *Proc. Amer. Soc. Hort. Sci.* 51: 552-562.

- Darwin, Charles R. (1882). *The Formation of Vegetable Mould Through the Action of Worms, With Observations on their Habits*. D. Appleton Co., New York. 326 pp.
- Dawson, Roy C. (1948). Earthworm microbiology and formation of water-stable soil aggregates. *Jour. Soil. Sci. Soc. Amer.* 12: 512-515.
- Hopp, Henry (1947). The ecology of earthworms in cropland. *Proc. Soil Sci. Soc. Amer.* 12: 503-507.
- \_\_\_\_\_, and Homer T. Hopkins (1946a). Earthworms as a factor in the formation of water-stable aggregates. *Jour. Soil and Water Conserv.* 1: 11-13.
- \_\_\_\_\_, and Homer T. Hopkins (1946b). Earthworms in relation to farming: An unsolved problem. Paper read before the annual meeting of the Ecological Society of America, Boston, December 28. 7 pp.
- \_\_\_\_\_, and Paul J. Linder (1947). Principle for maintaining earthworms in farm soils. *Sci.* 105: 663.
- \_\_\_\_\_, and Clarence S. Slater (1948). Influence of earthworms on soil productivity. *Soil Sci.* 66: 421-428.
- Hutchens, Lynn H. (1947). Propagation and maintenance of some natural fish bait and foods. *Ill. Nat. Hist. Survey* (mimeo). 8 pp.
- Lunt, H. A., and H. G. M. Jacobson (1944). The chemical composition of earthworm casts. *Soil Sci.* 58: 367-375.
- Olson, H. W. (1928). Earthworms of Ohio, with a study of their distribution in relation to the hydrogen ion concentration, moisture, and organic content of the soil. *Ohio Biological Survey*, Vol. 4, No. 2, Bul. 17. 55 pp.
- Powers, L. W., and W. B. Bollen (1935). The chemical and biological nature of certain forest soils. *Soil Sci.* 40: 321-330.
- Russell, Edward John (1950). *Soil Condition and Plant Growth*. Longmans, Green and Co., New York. 635 pp.
- \_\_\_\_\_. (1910). The effect of earthworms on soil productiveness. *Jour. Agr. Sci.* 3 (Part II): 246-257.
- Slater, C. S., and Henry Hopp (1947). Relation of fall protection to earthworm populations and soil physical conditions. *Soil Sci. Soc. Amer.* 12: 508-511.
- Stephenson, J. (1930). *The Oligochaeta*. Clarendon Press, Oxford. 978 pp.
- Stinauer, R. F. (1951). Life histories and culture of earthworms. Thesis for degree of M. S., Mich. State Univ., East Lansing. (Unpublished)
- Swingle, H. S., and D. C. Sturkie (1944). Raising fishworms for bait. *Ala. Agr. Expt. Sta. Series 5* (mimeo). 3 pp.
- Wallace, George (1948). Earthworms, their care and culture. *Mich. State Univ. Dept. Zoo.* mimeo. 7 pp.
- Walton, Izaak (1653). *The Compleat Angler; or The Contemplative Man's Recreation*. Word, Luck and Co., London. 106 pp.



Cooperative Extension Service Programs are open to all without regard to race, color, creed, or national origin. Issued in furtherance of cooperative extension work in agriculture and home economics, acts of May 8, and June 30, 1914, in cooperation with the U.S. Department of Agriculture. Gordon E. Guyer, Director, Cooperative Extension Service, Michigan State University, E. Lansing, MI 48824

3P-1:77-10M-RO, Price 30 cents.