

## **MSU Extension Publication Archive**

Archive copy of publication, do not use for current recommendations. Up-to-date information about many topics can be obtained from your local Extension office.

Improve Your Household Storage  
Michigan State University Extension Service  
Eunice A. Pardee, Coral K. Morris, Home Management  
Reprinted July 1962  
20 pages

The PDF file was provided courtesy of the Michigan State University Library

**Scroll down to view the publication.**

Improve Your

# Household Storage



**Michigan State University**

**Cooperative Extension Service  East Lansing**

## Improve Your

# Household Storage

By EUNICE A. PARDEE and  
CORAL K. MORRIS

*Extension Specialists in  
Home Management*

## CONTENTS

- 3 *Introduction*
- 4 *Bedroom closets*
- 6 *Coat closets*
- 8 *Dining room storage*
- 9 *Sewing equipment*
- 10 *Living room storage*
- 12 *Bedding and linens*
- 13 *Bathroom storage*
- 14 *Cleaning equipment*
- 15 *Sports and hobbies*
- 15 *Toys*
- 16 *Laundry area*
- 16 *Workshop*
- 17 *Garden tools*
- 18 *Suggestions*
- 20 *Storage principles*

All photographs and drawings (except as indicated below) reproduced through courtesy of the University of Illinois Agricultural Experiment Station from Bulletin 557, *Space Design for Household Storage*, by Helen E. McCullough.

Dining Room Storage Cabinet, p. 8, courtesy Extension Service, Institute of Agricultural Sciences, State College of Washington, Extension Bulletin 436, *Storage for Your Home*.

Toy Storage, p. 15, courtesy E. H. Sheldon Equipment Co., Muskegon, Mich.

Garden Tools, p. 17, courtesy Woman's Day.

# What is GOOD STORAGE?

GOOD STORAGE can do more to simplify daily living than any other single factor in housing. Proper storage at the point of use is a great asset to any house. Homemakers are quick to say their biggest problem in storage is lack of space.

One reason for too little storage space is our habit of holding on to things that are never used. Often these "never used" and those "seldom used" articles occupy some of the best storage space.

Today we have more food, clothes, furniture, equipment, toys, and tools and many other things to store than families used to have. Many families are living in small houses with no attic or basement or in houses built 25 to 50 years ago when there was much less to store. With these many articles, homes can become cluttered and unattractive unless they contain storage space where things stored can be readily reached when needed.

For example, supplies of soap, tissue, towels, and toilet accessories are used in the bathroom and should be stored there. Other items such as linens and cleaning equipment may be used in several locations. Centrally located storage is best for these things.

If you are going to have organized storage in either a new house or your present home, you will need to plan carefully, for good storage doesn't just happen. Store your household belongings today where you can use them tomorrow.

Plan for improving your storage by:

- Listing the articles you have to store.
- Deciding where they will be first used.
- Determining the kind and amount of space needed to fit the things to be stored.

Families have different types of articles to be stored and different quantities of each. They also have different ideas as to where they want to store the articles; these ideas change over a period of years. Therefore for efficiency and economy, storage units should be as flexible as possible.

This bulletin gives you ideas, suggestions, and guides to go by in planning your storage needs for:

- *Amounts and types of storage needed.*
- *Ways to improve storage space already available.*
- *Ways to increase storage facilities within the home.*
- *Location of storage areas.*

# BEDROOM

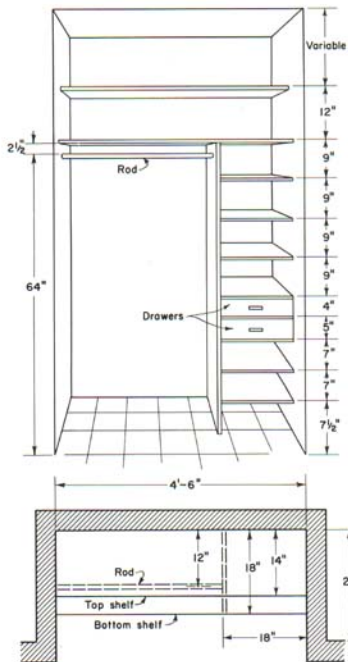

BEDROOM CLOSET  
DESIGNED  
FOR  
ONE PERSON

Lack of clothing storage space is a major problem for many families. Closets are too few and too small. Research has shown that each person in the family needs a total of at least 48 inches of rod space for hanging up clothing.

Some other measurements to guide you in planning closets:

From floor to rod —

- 63 inches for street dresses
- 45 inches for suits, blouses, and skirts
- 72 inches for floor-length dresses
- 30 inches for 3- to 5-year olds
- 45 inches for 6- to 12-year olds

- 11 to 15 inches depth of shelf above rod
- 11 inches depth of second shelf above rod
- 9 inches allowance between shelves for shoes
- 24 inches minimum depth

Making your clothing storage space easy to use

- When two persons use the same closet, it is helpful to divide it so that each one has his own section. Plan so that nothing stands on the closet floor.
- Have pull-out trays for underwear, sweaters, shirts and other clothing. Use adjustable shelf space or racks for shoes, hats, purses and ties. Make these easy to reach.
- Full front openings to all storage is most desirable.
- Hinged doors usually give the best use of space since racks for accessories can be hung on the door. However if space in front of the closet is limited, folding or sliding doors can be used.
- Children's closets need adjustable and removable rods and fittings.
- Usually shallow drawers offer you more space which is easily accessible.

# CLOSETS

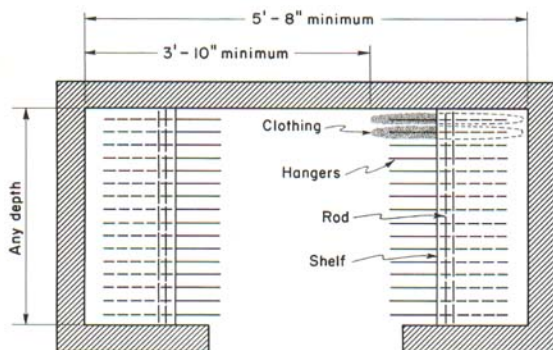

2-ROD  
WALK-IN  
CLOSET

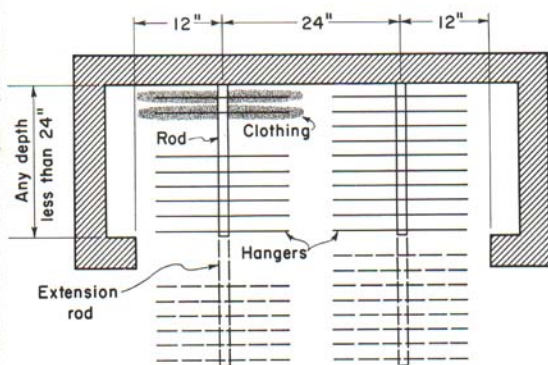

VERY  
SHALLOW  
CLOSET

# COAT

Most homes need at least two coat closets — one for good wraps, another for children's play wraps and work clothes.

The closet used for visitors', town, or school wraps is best located near the front entrance. It should contain ample rod space so that garments will not be crushed or wrinkled. A mirror, storage space for scarfs, umbrellas, purses, and hats should be provided.

The second closet for wraps should be located near the back entrance. It is important to store play wraps and work clothes so they are easy to put away and to get out. Hooks rather than rods are usually used. A shelf or bins on the door for caps and mittens are a convenience. A removable rack made of slats is efficient for rubbers and overshoes. It should be placed high enough from the floor to permit the use of a plastic tray under it.

Good ventilation is imperative in the storage of work clothes. Louvered doors or openings at the top and

bottom of the door will keep air circulating. Keep wraps used in cold or rainy weather in a warm room. A small electric light bulb kept burning will maintain the proper temperature.

Fittings in a coat closet should be adjustable and removable to suit the changing needs of family members.

Hooks with 2 prongs should be provided for garments not needing hangers.

An extension rod which can be pulled out is convenient in a narrow, deep closet or a very shallow one.

An electric light is necessary in most closets.

Study your closets to know what your family needs. Maybe you do not need new closets, but only need to make better use of the space you now have. Planning will help you see what you need and how you can provide it.

COAT  
CLOSET

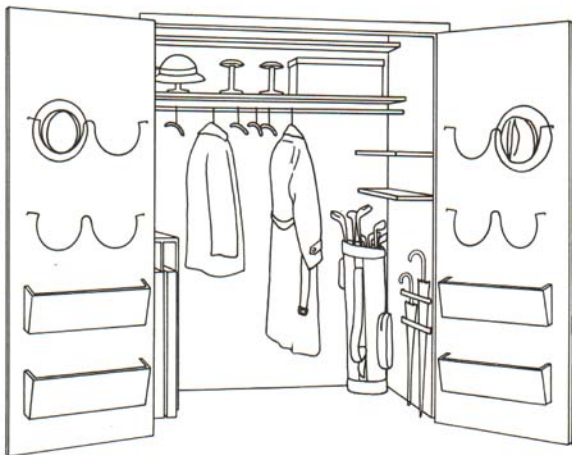

# CLOSETS

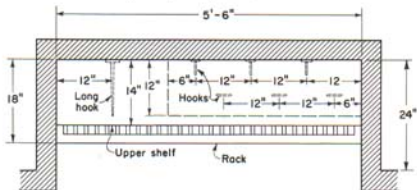
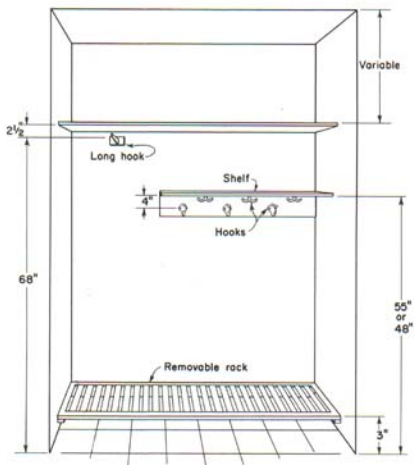
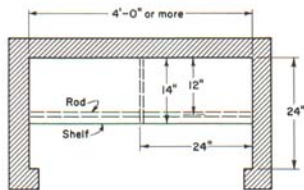
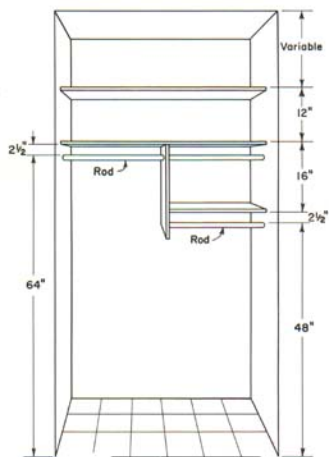

▲ COAT CLOSET  
FOR BOTH  
CHILDREN & ADULTS

▲ "CHORE" COAT CLOSET



# DINING ROOM

Many families today eat most of their meals in the kitchen. Whether you eat in the kitchen, in the dining room, or in the living room you need some storage space. Wherever you eat you will want to store table linens, some electrical equipment, and salt and pepper shakers. You may wish to keep your best dishes and silver in the dining area although some homemakers prefer to keep all dishes in the kitchen.

Shallow drawers or pull-out trays are best for storing

linens as they pull out easily, and linens wrinkle less in shallow than in deep drawers.

A dining room closet or cabinet should have a door to enclose dishes. Shelves should be adjustable and removable.

A cupboard built under a window is useful for storing electrical equipment and dining room supplies, or a buffet may be used. Plan carefully so that you use all space efficiently.



## DINNERWARE

Shelves for dishes should be 12 in. deep and adjustable. Only enough space above stacks for easy removal of items is needed. Store silver and linen in drawers or trays 20 to 24 in. deep below the shelves. This unit is 36 in. wide. Minimum width should be 20 in.



## TABLE LINENS

Pull-out shelves and shallow trays are ideal for preventing wrinkling in stored table linens. They can be taken to the laundry room and linens can be placed on them when ironed. Suggested heights:

Drawers, 4-6 in.

Trays, up to 4 in.

Distance between pull-out shelves and trays—2 in. This unit should be 16 to 20 in. deep and 20 in. wide. Height is variable.

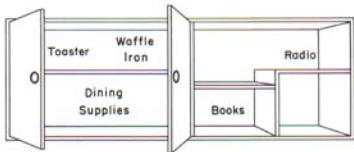

## DINING ROOM STORAGE CABINET

# SEWING EQUIPMENT

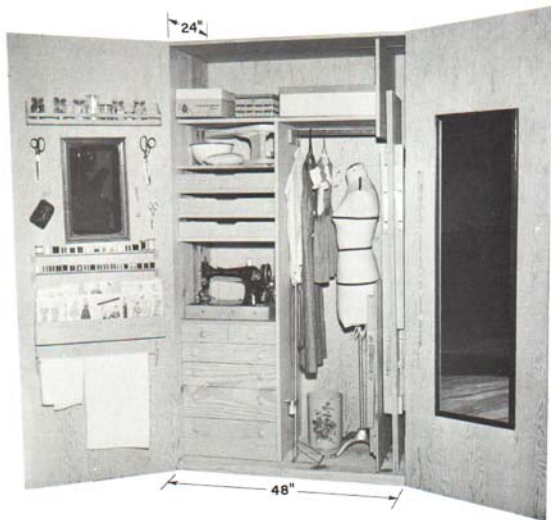

This full-height unit provides storage for all kinds of sewing equipment and supplies. Space for a sewing machine should be large enough to accommodate the largest portable machine. Width: at least 48 in.; width of drawers, 24 in.; width of compartment for hanging clothes, at least 24 in.

The homemaker usually sews a little at a time after her routine housework is done. The best place to keep sewing equipment and supplies is in a closet off the bedroom or dining room or near wherever she sews.

The sewing closet needs an open shelf for baskets, patterns, magazines, and boxes. One section can provide shallow drawers for patterns, trimmings, and pieces of cloth. Deeper drawers are better for mending and larger articles. A drawer space large enough to house the portable machine should be included if one is used. Drawers should be 24 inches wide.

One section of the closet should provide a rod for

hanging garments being constructed or mended, space for dress form, ironing board, if desired, and waste basket. This space should be at least 24 inches high.

Storage on the inside of the doors is desirable. Hinged doors are necessary for this. On one door you can fasten a rack for patterns, one for thread, another for containers holding small supplies as well as hooks for scissors. A full length mirror can be hung on the other door.

If this space is not available, carefully plan for storage of most used sewing needs at the point of use.

# LIVING

In most homes the living room or family room is the place where family members spend a good share of their leisure time. Here they read, write letters, play games and musical instruments, or pursue other hobbies.

There should be storage space for books and magazines near at hand. These articles may be kept in closets with adjustable shelves and without doors, or on open shelves. Shelves of bricks and boards are inexpensive and easily made.

A desk which provides space for writing and storing writing supplies and for business papers is needed in every home. It may be located in the living room. Business papers may be stored in a separate unit if the family desires.

Today many families need storage space for a record

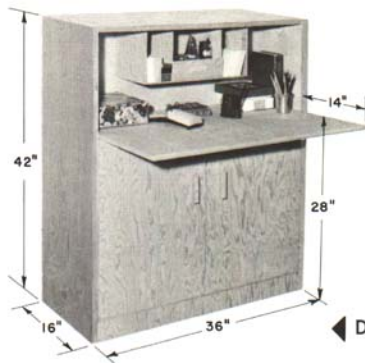

## ◀ DESK

This unit provides writing and storage space. A 36-in. width is preferred; a 32-in. wide unit is minimum. Other dimensions shown may be followed for best results. Book shelves may or may not be included.

## RADIO-PHONOGRAPH ▶

This unit is 16 in. deep and 36 in. wide. It holds large albums to a height of 14 in. The radio and record-player compartment should be at least 12 in. high. Book shelves may or may not be included.

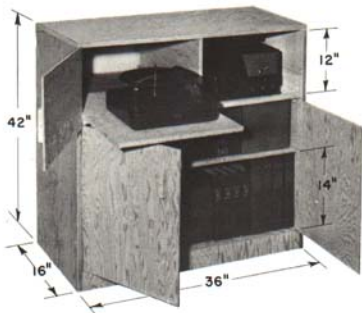

# AREA STORAGE

player and records. And they may need a place for band instruments, sheet music, and music racks. A closet with adjustable shelves located off the living room may provide storage for these articles.

Toys used in the living room may be stored here. Drawers, trays, or enclosed shelves for such storage prevent the room from having a cluttered appearance. Open shelves for toys may be more suitable in a play room or a child's own room.

Storage space for card tables and folding chairs is necessary today. A section of a closet near the living room may provide this space. Another solution is to store tables on a hinged rack fitted in front of the chairs.

You can combine and arrange the ideas suggested here to suit your family needs and space available.



## ▲ FOLDING CHAIRS & TABLES

The tables in this unit are stored on a hinged rack parallel with cabinet door. Chairs are stored in 2 rows back of the tables. The cabinet is 24 in. deep. Width: at least 36 in. — wider if chairs are 18 in. or wider and table tops larger than 30 in. Height of unit: 40 in. (Allow a margin above the folded chairs).



## ◀ MUSICAL INSTRUMENTS

This unit is 16 in. deep. Depth depends on base of the music stands. Number and kinds of instruments determine width and height. Place adjustable shelves above the tallest article stored on base of the unit.



## ◀ BUSINESS PAPERS

A 16-in. (front to back) metal file will fit this cabinet. Depth depends on type of cabinet. Most metal files are about 15 in. wide. Inside width should be slightly wider than the file. Height is variable.

# BEDDING AND LINENS

A hall closet near the bedrooms is convenient for storing bedding and towels. Full width, full height doors make all the storage space available.

Trays or shelves make it easy to store bedding. They have an advantage over drawers in that they may be placed on supports which make it possible to adjust the spacing. Another advantage is that contents are more easily seen. Trays should always be used in closets that are more than 18 inches deep.

Removable, adjustable shelves may be used near the

top of the closet for the seldom-used articles.

A sorting board or shelf makes it easy to sort linen for storing. This may be a hinged board or a pull-out one which fits under a shelf at about waist height.

Sheets, pillow-cases, and towels are more easily reached if stored in several low stacks rather than a few high ones. You should be able to get the article you wish, without having to move others.

Store articles used most often within the easy-reach area.



## BEDDING

This unit is 24 in. deep and 24 in. wide. Height is variable. Top and bottom trays have a usable height of 12 in. each. Other trays may be made to vary from 4 to 9 or 10 in. A pull-out sorting tray can be placed at waist height.

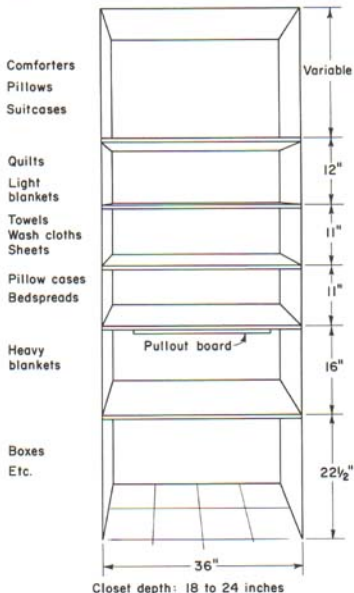

## LINEN CLOSET

# BATHROOM STORAGE

Many homes have inadequate storage for bathroom supplies and equipment. An analysis of what is used in the bathroom will suggest the storage space needed. Provide storage for the following:

- Bath towels, hand towels, wash cloths, bath mats.
- Toilet supplies and equipment, reserve supplies of facial tissues, toilet paper, and soap.
- Wastebasket.
- Cleaning supplies and equipment used in bath room.
- Medicines, disinfectants, and first aid kit.
- Family member personal supplies.
- Clothes hamper, if chute is not installed.
- Hot water bottle.
- Infant's wear and special bath equipment.

## BATHROOM SUPPLIES

This unit of 16-in. depth can store a foot tub and large bath towels folded in thirds. A locked compartment should be provided for medicines and lotions, if there are small children in the family. The unit should be full height and at least 24 in. wide.

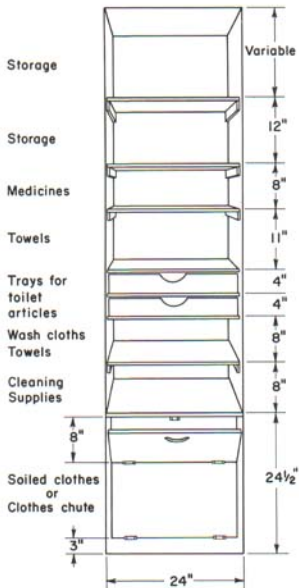

## ▲ BATHROOM CLOSET

Convenient arrangements for bathroom storage:

- A shallow wall cabinet, with sliding doors, for bottles. Removable and adjustable shelves.
- Towel rods of sufficient number for family members and guests.
- Shallow drawers for tooth paste, cream, and small flat articles.
- Closet for towels.
- Large double hook for hanging a robe or other garment.

# CLEANING EQUIPMENT

Storage space for cleaning equipment makes any home more attractive. Many houses have no such storage space. In most of those houses a cleaning closet can be built at small cost. It should have shelves to store cleaning supplies and hooks or clamps for equipment that will hang. A section of wall covered with peg board is an aid to efficient storage. This closet is also a good place to keep extra table leaves in a special case or dividers. The ironing board may be stored here.

Inside walls finished with washable enamel or plastic will be easily cleaned and impervious to oil.

A closet in the living area is ideal for storing the vacuum cleaner and attachments, dust cloths, and dry mops which are used in this area.

Cleaning equipment can be stored best in a unit 16 inches deep and 36 inches wide, as articles are most accessible in a closet of these dimensions.

Two shelves may be useful. The top one should be within reach of the woman of average height. The lower shelf height is determined by the height of the tallest equipment.

Hinged doors provide extra storage space.

A unit 16 in. deep and 36 in. wide, or one 24 x 24 in. is sufficient to store cleaning equipment. One or two shelves may be placed at the top within reach of a woman of average height. Place them high enough to store tall equipment. Allow 63 in. for storing folded ironing board.



CLEANING  
EQUIPMENT

# SPORTS AND HOBBIES



Sports and hobby equipment are best stored near an outside door. Because of the number and variety in size and shape of sports articles, as well as differences in family interests, be sure to provide special racks, compartments, shelves and hooks.

Planned spaces are needed for such equipment as guns, fishing equipment, movies, golf bags, baseball, and tennis. These are but a few of the recreational articles which many families must store.

Flexibility, which is so essential to sports and hobby storage, can be achieved through adjustable shelves or by the use of peg board.

## SPORTS EQUIPMENT

Racks, compartments, and shelves can conveniently store many kinds of sports equipment. Movie screen compartment is 65 in. high; gun compartment is 48 in. high, 8 in. wide, and 8 in. deep. Use hooks for many small items. Width depends on the number and kinds of articles. It is full height.

# TOYS

Shelves for toys can be built of plywood or other wood and can be open or enclosed. Such shelves are usually located in the family room or the child's own

room and can be made to fit whatever space is available. Crates may also be used if they are made sturdy and attractive.

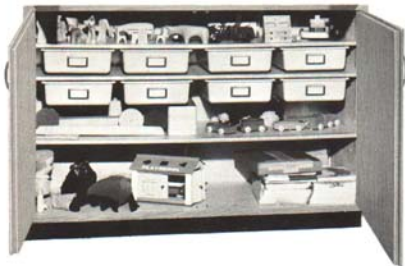

This unit for indoor toys has adjustable shelves. Plastic pullout trays under shelves make good storage for small articles.

Width: variable—  
Height: children can reach all shelves if cabinet height is not more than 48 in.



# LAUNDRY AREA

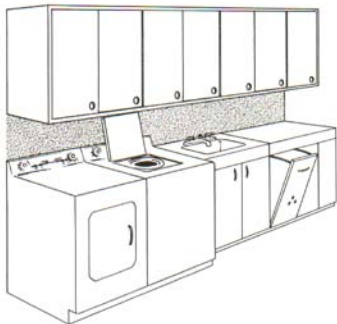

Many homes provide little or no storage space in the laundry area. For greatest efficiency, store supplies and equipment in closed cabinets, with adjustable shelves, at the point of use, and within easy reach, at the washing machine and sink.

A built-in ironing board or a free-standing one for the laundry area is a matter of personal preference. You should have closet space for the free-standing board where it is most readily accessible at the point of use. The iron should also be stored here. A closet 60 inches high and 16 to 18 inches front-to-back will provide space for the ironing board.

When the laundry is done in the kitchen, make some provision for storing soiled clothes in some other area of the house.

# WORKSHOP STORAGE

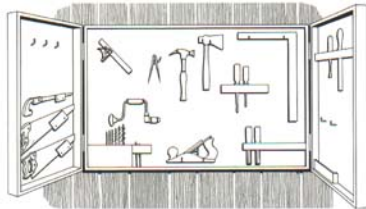

A well-planned workshop should save you time and money because of the repairs and other work you can do yourself. It is the best place to store both supplies and tools for all types of repairs.

Regardless of the size of your shop, follow these rules:

- Store your most used things within the easy-reach area.
- Have an orderly arrangement – a tool cabinet with hinged doors that open up twice its width and holds all the basic tools.

- Peg board attached to the wall provides good storage space for handling tools and many kinds of equipment.

Make your shop safe –

- Provide orderly storage for nails, screws, bolts, machine parts and other supplies. Use small bins, glass jars, or clear plastic containers.
- Keep oil and grease in covered containers. Keep gasoline only in small quantities and in a red can.

# GARDEN TOOLS



Tools for the yard and garden are best stored out of doors in a dry place that can easily be reached from outside the house. Most families use the garage or carport. Hooks of various sizes and shapes can be used to hang all kinds of tools and equipment on peg board which has been attached to the walls. Fasten this board to the studs; or if wall is sealed, mount the board on strips to insure at least  $\frac{1}{2}$  inch clearance for manipulation of hooks.

Arrange tools so that each has its own spot within easy reach.

Keep dust and sprays in a waterproof place on high shelves or locked in a cabinet.

Put large equipment as near the doorway as possible but out from underfoot.

Tricycles, bicycles, wagons, scooters, and other wheeled toys are dangerous when left on walks or in the yard. Storage space in the garage for these things will encourage children to take care of their property.

**Suggestions  
for  
providing  
MORE  
STORAGE  
in  
your home**

**THE DEEP CLOSET**

**BEFORE**

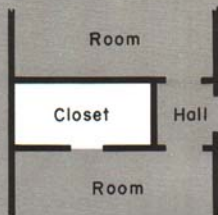

**AFTER**

**If  $4\frac{1}{2}$  to 5 feet deep**

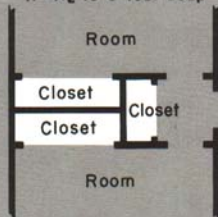

**AFTER**

**If  $3\frac{1}{2}$  to 4 feet deep**

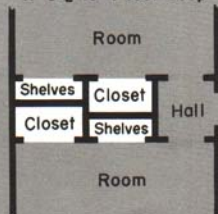

# THE LONG NARROW CLOSET

BEFORE

AFTER

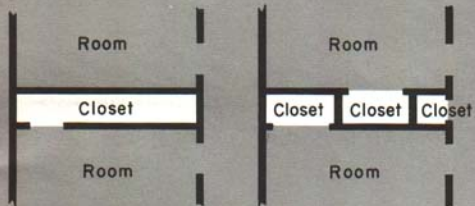

Closets taken from large room:

BEFORE

AFTER

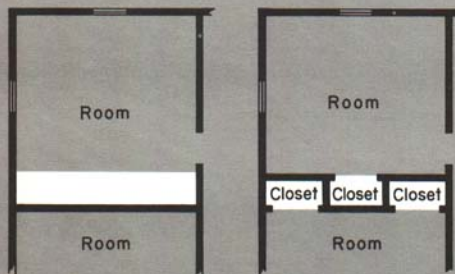

Closets on either side of door or window:

BEFORE

AFTER

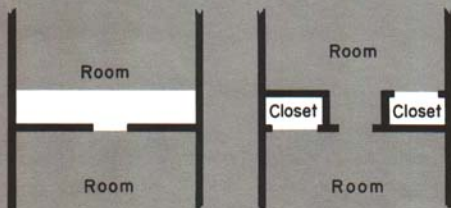

# Principles of GOOD STORAGE

- Get rid of unused articles
- Store at point of use
- Store within easy reach the things  
you use most often
- Plan storage spaces to fit articles  
to be stored
- Put articles in their planned space

Cooperative extension work in agriculture and home economics. Michigan State University and the U. S. Department of Agriculture cooperating. N. P. Ralston, Director, Cooperative Extension Service, Michigan State University, East Lansing. Printed and distributed under Acts of Congress, May 8 and June 30, 1914.

3P-762-10M-JH

