

MSU Extension Publication Archive

Archive copy of publication, do not use for current recommendations. Up-to-date information about many topics can be obtained from your local Extension office.

Insulate Your Basement Walls: A Moderately Easy Do-It-Yourself Project

Michigan State University

Cooperative Extension Service

James S. Boyd, Agricultural Engineering and Human Environment and Design

Department

July 1977

6 pages

The PDF file was provided courtesy of the Michigan State University Library

Scroll down to view the publication.

INSULATE YOUR BASEMENT WALLS

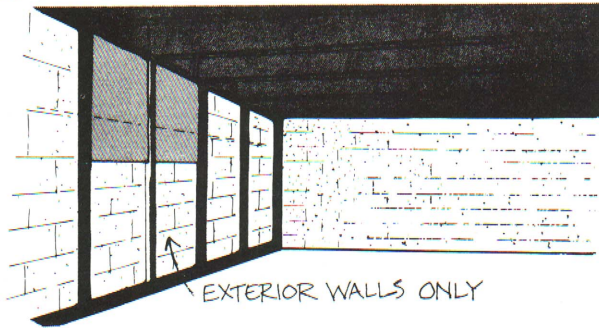







A MODERATELY EASY DO-IT-YOURSELF PROJECT

Install 2" X 3" studs along the walls to be insulated. Add glass fiber blanket insulation between the furring strips and finish with wallboard or panelling.

NOTE: The method of insulation shown here should not be used by residents of Alaska, Minnesota, and northern Maine. The extreme frost penetration in these areas can cause heaving of the foundation if the insulation method shown here is used. Residents of these areas should contact local HUD/FHA field offices for advice.

Tools

1. Saw 
2. Hammer, nails 
3. Heavy duty staple gun, or hammer and tacks 
4. Tape measure 
5. Linoleum knife or heavy duty shears 
6. Level 
7. Small sledge hammer, masonry nails 

Safety

1. Provide adequate temporary lighting
2. If you use glass fiber or rock wool, wear gloves and a breathing mask, and keep the material wrapped until you are ready to use it

Materials

What you'll need

1. R7 (2-2½ inch) Batt or blanket insulation, glass fiber or rockwool, with a vapor barrier (buy polyethylene if you can't get batts or blankets with a vapor barrier)

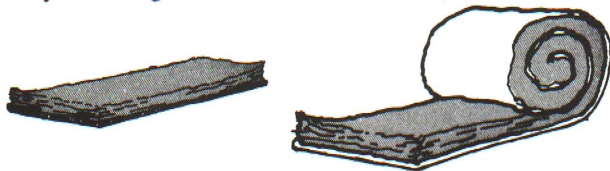

2. 2" X 3" studs



3. Drywall or panelling

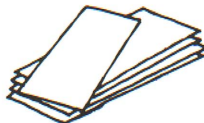

4. Waterproof paint, if necessary



How much

1. Find the average height above the ground of the walls you intend to insulate and add two feet. Then measure the length of the walls you intend to insulate. Multiply the two figures to determine how many square feet of insulation is needed.

$$\begin{array}{l} \text{(height) X (length) = area} \\ \text{______ X ______ = ______} \end{array}$$

2. Find the linear feet of studs you'll need by multiplying the length of the walls you intend to insulate by (6).

$$\begin{array}{l} \text{(6) X (length) = (linear ft.)} \\ \text{(6) X ______ = ______} \end{array}$$

3. The area of wall covering equals the basement wall height times the length of wall you intend to finish.

$$\begin{array}{l} \text{(height) X (length) = area} \\ \text{______ X ______ = ______} \end{array}$$

COOPERATIVE EXTENSION SERVICE • MICHIGAN STATE UNIVERSITY

Installation

Preparation

Check to see whether or not moisture is coming through your basement walls from the ground outside. If it is and your walls are damp, you should eliminate the cause of the dampness to prevent the insulation you're going to install from becoming wet and ineffective.

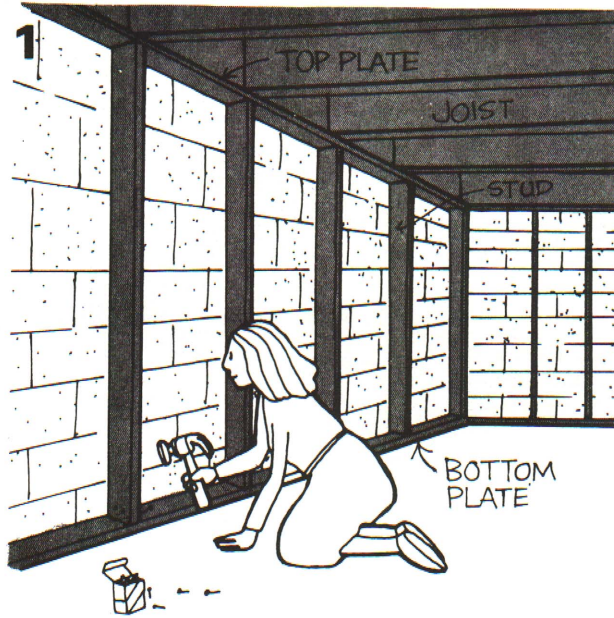

Nail the bottom plate to the floor at the base of the wall with a hammer and concrete nails. Install studs 16 or 24 inches apart after the top plate is nailed to the joists above. (Where the wall runs parallel to the joists, nail the top plate to the tops of the studs, and fasten the studs to the wall.)

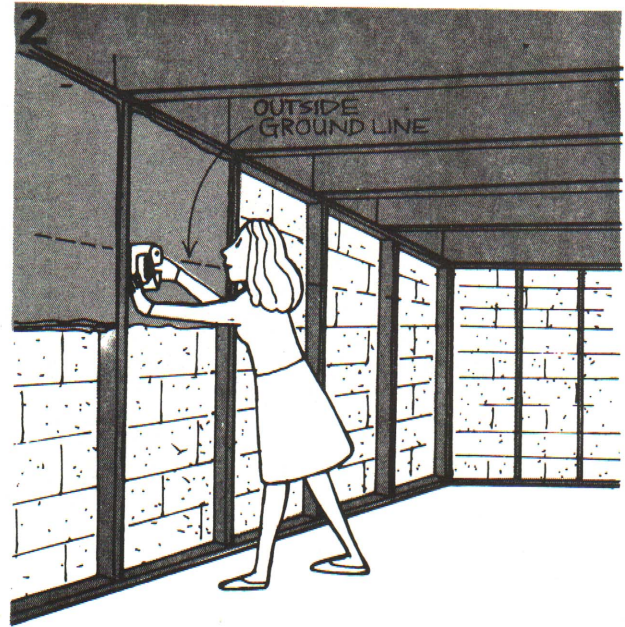

Cut blankets into sections long enough to extend from the top plate to 2 feet below the ground line. Staple them into place between the studs, with the vapor barrier towards the living space. **NOTE:** in northern climates there will be added benefit to installing the insulation the full height of the wall.

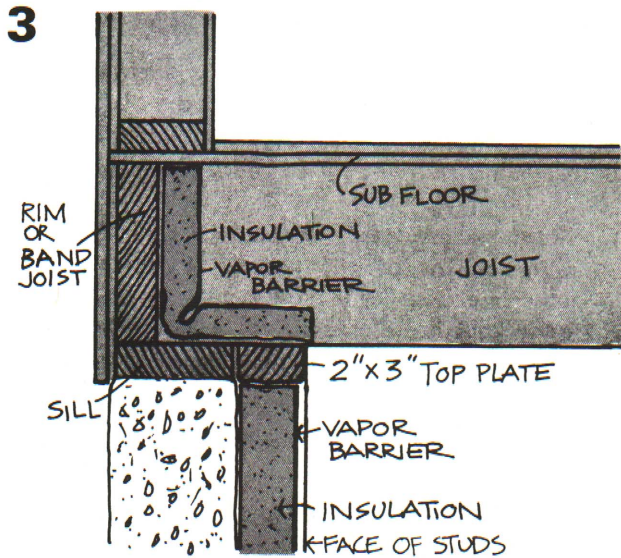

Install another small piece of insulation above the furring and against the sill to insulate the sill and band joist.

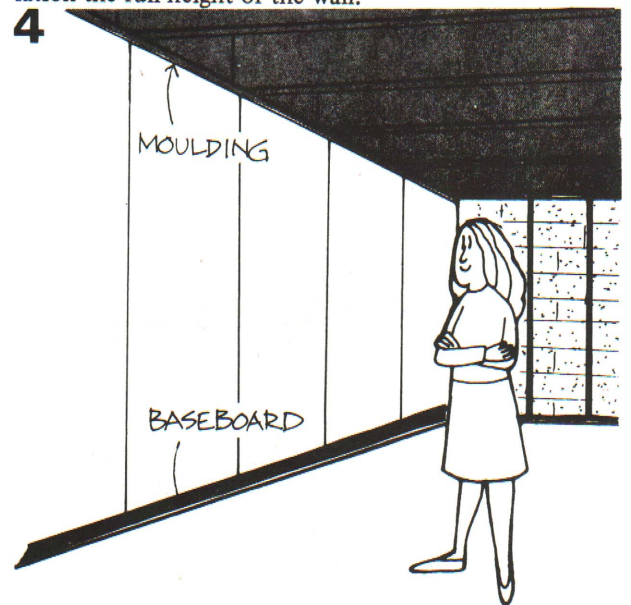

Install finish wall board or panelling over insulation and furring.

INSULATE YOUR CRAWL SPACE WALLS

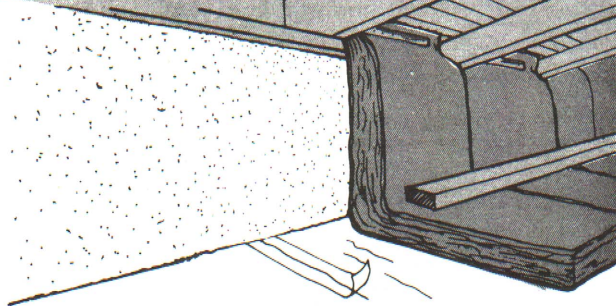





TWO OPTIONS AVAILABLE

(1) **Do-It-Yourself:** Install batt or blanket insulation around the walls and perimeter of your crawl space. Lay a plastic vapor barrier down on the crawl space earth.

(2) **Contractor Installed:** If your crawl space presents access or working space problems, you may want to consider having a contractor do the work for you. The contractor will probably follow a method similar to the do-it-yourself method described below. But if he suggests something different, have him price both methods and show you which is better. See page 64 for advice on how to select a contractor.

NOTE: The method of insulation shown here should not be used by residents of Alaska, Minnesota, and northern Maine. The extreme frost penetration in these areas can cause heaving of the foundation if the insulation method shown here is used. Residents of these areas should contact local HUD/FHA field offices for advice.

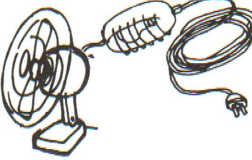
Tools

1. Hammer and nails 
2. Heavy duty shears or linoleum knife 
3. Temporary lighting 
4. Portable fan or blower to provide ventilation
5. Tape measure 
6. Duct or Masking Tape (2" wide) 

Safety

1. Provide adequate temporary lighting
2. Wear gloves and a breathing mask when working with glass fiber or rock wool
3. Provide adequate ventilation
4. Keep lights, fan, and all wires well off wet ground

Materials

What you'll need

1. R11 (3-3½" thick) blankets of rock wool or glass fiber; without a vapor barrier

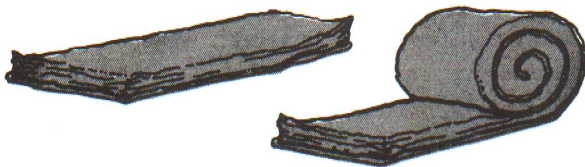

2. Six mil polyethylene plastic to lay on earth for vapor barrier (mil's are a measure of thickness)



3. 1/2" X 1-1/2" stock for nailing strips at the sill and at the band joist.



How much

1. Determine area to be insulated; measure the length and average height of the wall to be insulated; add 3' to the height (for perimeter insulation) and multiply the two to find total insulation area

$$\text{(length)} \times \text{(height} + 3') = \text{area}$$

$$\underline{\hspace{2cm}} \times \underline{\hspace{2cm}} + 3' = \underline{\hspace{2cm}}$$

2. Determine the area to be covered by the vapor barrier by finding the area of your crawl space

$$\text{(length)} \times \text{(width)} = \text{area}$$

$$\underline{\hspace{2cm}} \times \underline{\hspace{2cm}} = \underline{\hspace{2cm}}$$

You may have to divide your crawl space into several rectangles – measure them and add up the areas.

(length)	X	(width)	=	_____
_____	X	_____	=	_____
_____	X	_____	=	_____
_____	X	_____	+	_____
TOTAL			=	

3. The total length of nailing strips required equals the length of wall to be insulated

Installation

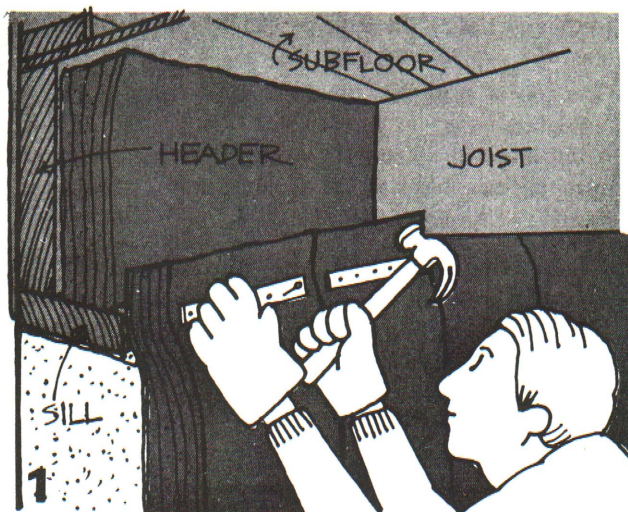

Drawing 1: Where the joists run at right angles to the wall, press short pieces of insulation against the Header — they should fit snugly. Then install the wall and perimeter insulation by nailing the top of each strip to the Sill using the 1/2" X 1-1/2" nailers. Make sure the batts fit snugly against each other, and that you cut them long enough to cover 2 feet of floor as in Drawing 2.

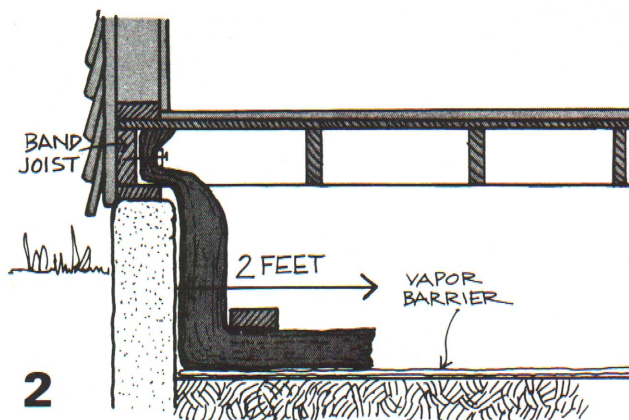

Drawing 2: Where the joists run parallel to the wall, you don't need the short pieces of insulation, just install the wall and perimeter insulation by nailing the top of each strip to the Band Joist, using the 1/2" X 1-1/2" nailers.

When all batts have been installed, lay down the polyethylene vapor barrier, tucking it under the batts all the way to the foundation wall. Tape the joints of the vapor barrier or lap them at least 6". Finally lay 2 X 4 lumber along the wall on top of the batts to weight the batts in place. (Rocks work well, too.) Plan your work to minimize stepping or crawling on the vapor barrier.

VENTILATING YOUR CRAWL SPACE

Even with a plastic vapor barrier on the floor, the air in your crawl space will be too damp if fresh air doesn't get in there from time to time. This will mean your new insulation will be wet, and it won't keep your house as warm. It will also mean that wooden members that hold up your house will be wet, and they'll rot. Proper ventilation will prevent both of these problems:

1. If your crawl space is part of your forced-air heating system (in other words, if air from your furnace moves through it), seal your crawl space as tightly as possible—the air moving through it from your furnace is enough ventilation in winter. If you have crawl space vents, keep them shut in winter, open in summer. If there are no vents, run the blower on your furnace 3 or 4 times during the summer to keep the air in the crawl space from getting too damp.

2. All other crawl spaces should have vents in them that can be opened in summer (to clear out the damp air), and closed **tightly** in winter to make the most of your new insulation. You can make a cover for them to install in winter. Note: Your furnace may get its combustion air from the crawl space. If so, some of the vents should be left open. Check with your local HUD/FHA office.

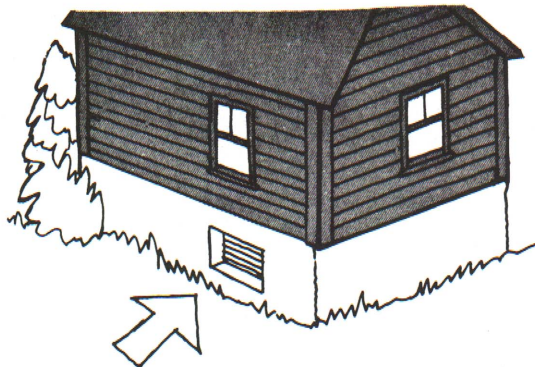

INSULATE YOUR FLOOR

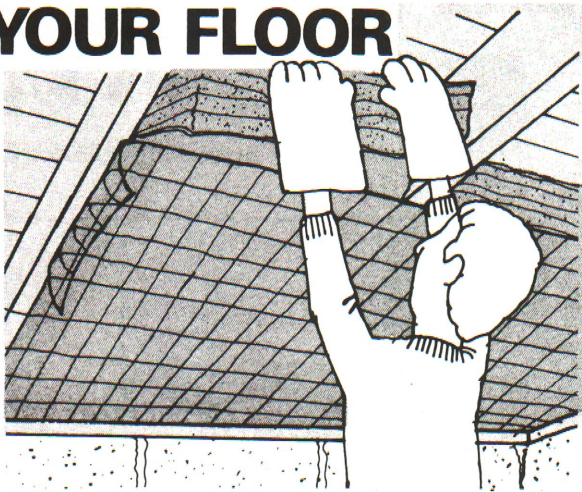

TWO OPTIONS AVAILABLE

1. DO-IT-YOURSELF

Install batts or blankets between the floor joists by stapling wire mesh or chicken wire to the bottom of the joists and sliding the batts or blankets in on top of the wire. Place vapor barrier up.

The job is quite easy to do in most cases. If you are insulating over a crawl space there may be some problems with access or working room, but careful planning can make things go much more smoothly and easily.

Check your floor joist spacing – this method will work best with standard 16" or 24" joist spacing. If you have non-standard or irregular spacing there will be more cutting and fitting and some waste of material.

2. CONTRACTOR INSTALLED

See page 6.

DO-IT-YOURSELF Tools

1. Heavy duty shears or linoleum knife
2. Temporary lighting with waterproof wiring and connectors
3. Portable fan or blower to provide ventilation
4. Tape measure
5. Heavy duty staple gun and staples

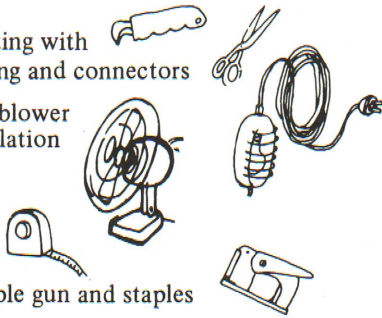

Safety

1. Provide adequate temporary lighting
2. Wear gloves and breathing mask when working with glass fiber or rock wool
3. Provide adequate ventilation
4. Keep lights and all wires off wet ground

Materials

What you'll need

1. R11 (3"-3½") batts or blankets or rock wool or glass fiber, preferably with foil facing (See Installation).

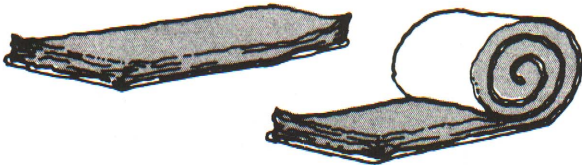

2. Wire mesh or chicken wire of convenient width for handling in tight space.

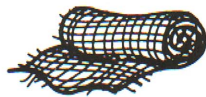

How much

Determine the area to be insulated by measuring the length and width and multiplying to get the area.

$$\begin{aligned} (\text{length}) \times (\text{width}) &= \text{area} \\ (\underline{\quad}) \times (\underline{\quad}) &= \underline{\quad} \end{aligned}$$

You may find it necessary to divide the floor into smaller areas and add them.

$$\begin{aligned} (\text{length}) \times (\text{width}) &= \text{area} \\ (\underline{\quad}) \times (\underline{\quad}) &= \underline{\quad} \\ (\underline{\quad}) \times (\underline{\quad}) &= \underline{\quad} \\ (\underline{\quad}) \times (\underline{\quad}) &= \underline{\quad} + \\ \text{total area} &= \underline{\quad} \end{aligned}$$

$$\begin{aligned} (.9)(\text{total area}) &= \text{area of insulation} \\ (.9)(\underline{\quad}) &= \underline{\quad} \end{aligned}$$

total area = area of wire mesh or chicken wire

Installation

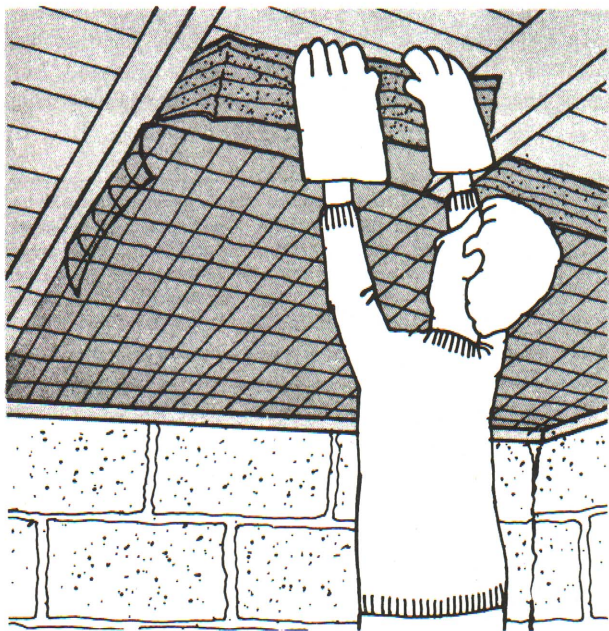

Start at a wall at one end of the joists and work out. Staple the wire to the bottom of the joists, and at right angles to them. Slide batts in on top of the wire. Work with short sections of wire and batts so that it won't be too difficult to get the insulation in place. Plan sections to begin and end at obstructions such as cross bracing.

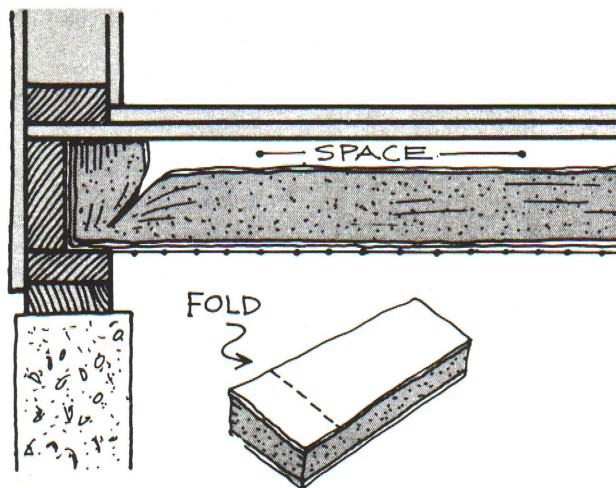

Buy insulation with a vapor barrier, and install the vapor barrier facing up (next to the warm side) leaving an air space between the vapor barrier and the floor. Get foil-faced insulation if you can; it will make the air space insulate better. Be sure that ends of batts fit snugly up against the bottom of the floor to prevent loss of heat up end. Don't block combustion air openings for furnaces.