

BELT PULLEY POWER LIFT

By A. J. BELL



Belt pulley lift in use.

MICHIGAN STATE COLLEGE
EXTENSION SERVICE
EAST LANSING

Cooperative Extension Work in Agriculture and Home Economics, Michigan State College and U.S. Department of Agriculture cooperating, R. J. BALDWIN, DIRECTOR EXTENSION SERVICE, Michigan State College, East Lansing. Printed and distributed under acts of Congress, May 8 and June 30, 1914.



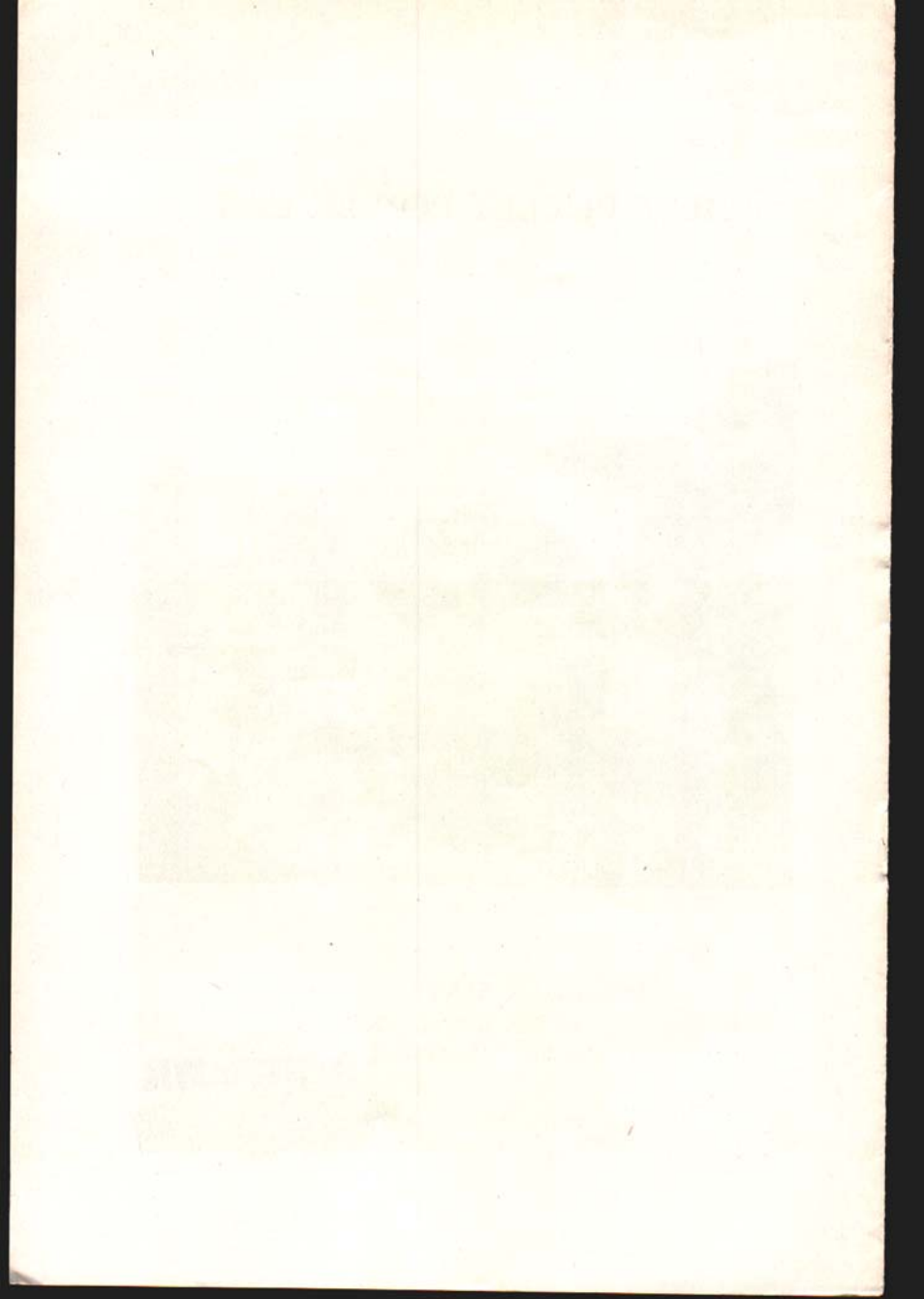

Belt Pulley Power Lift

Tractor attachments such as sweep rakes and manure loaders need some means of raising and lowering. The friction lift described in this bulletin is probably one of the easiest to build and one of the quickest and easiest to attach and detach. As shown on the Cover and in Fig. 1, it is simply an automobile wheel with a drum welded to it. This is mounted on the frame of the tractor in such a way that the tire can be pulled back to contact the belt pulley. A brake is installed on the other side of the tire to hold the load in any desired position.

An old automobile wheel, tire, spindle, and bearings are used in making this lift. A hole $1\frac{1}{8}$ " in diameter is drilled in a block of bar steel $\frac{1}{2}$ " x 4" x 5" with the hole centered $1\frac{1}{2}$ " from one end. A piece of round stock $1\frac{1}{8}$ " x $4\frac{1}{2}$ " is welded in this hole. This shaft varies in length on different tractors. For Farmall tractors, see Figs. 2, 3 and 4.

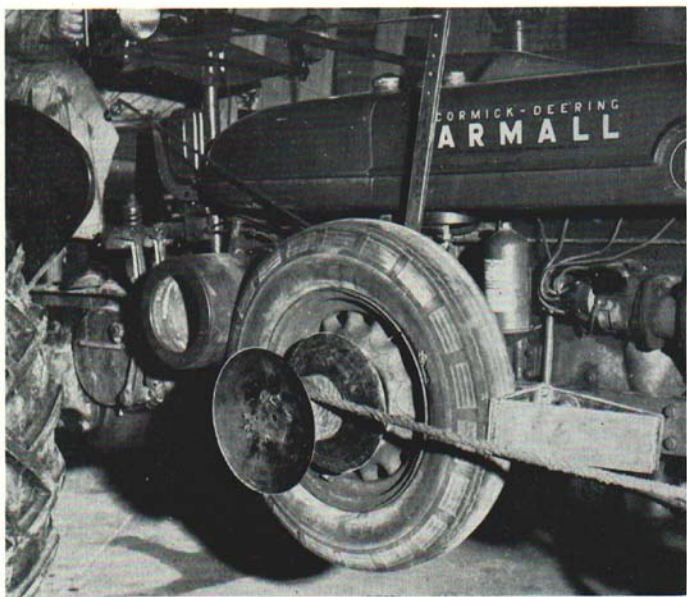

Fig. 1. Belt pulley lift installed.

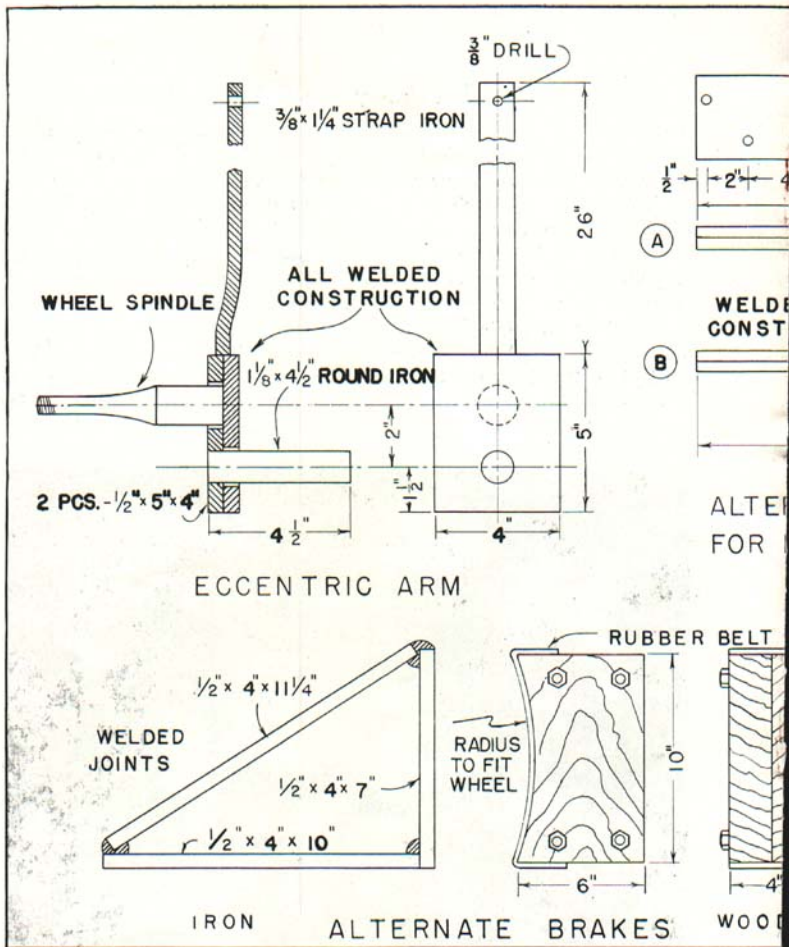
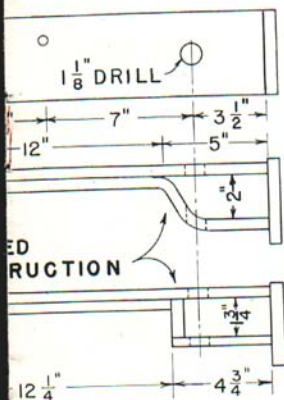
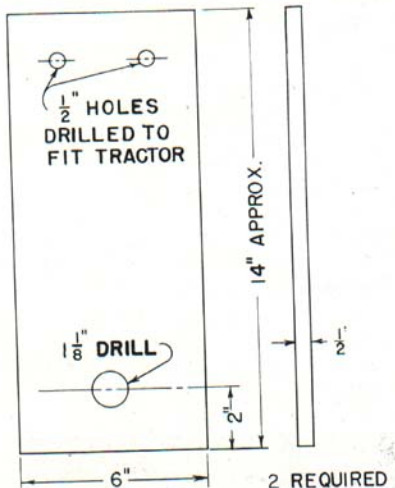

Fig. 2. Construction details



ORNATE HANGERS
H C - MODEL-H



2 REQUIRED
HANGER FOR JOHN DEERE,
ALLIS CHALMERS, ETC.

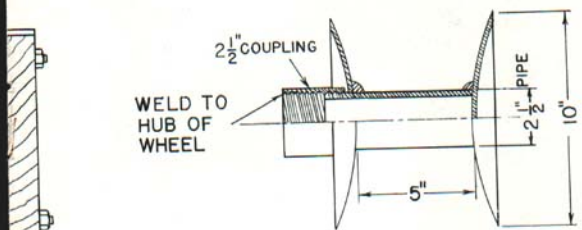

DRUM

ails, belt pulley power lift.

For John Deere and Allis-Chalmers, see Figs. 2 and 5. A spindle is next welded onto the opposite side of this bar of steel. The spindle is centered on the steel bar with its center 2" from the center of the $1\frac{1}{8}$ " shaft.

Drill a $1\frac{1}{2}$ " hole corresponding with the $1\frac{1}{8}$ " hole in a second piece of bar steel, $\frac{1}{2}$ " x 4" x 5". This is placed over the first piece, with the $1\frac{1}{8}$ " shaft extending through the $1\frac{1}{2}$ " hole. The two pieces are then welded together (Fig. 2).

A $\frac{3}{8}$ " x $1\frac{1}{4}$ " x 26" strap iron bent to miss tire and wheel is welded to the top of the block (Fig. 2). A $\frac{1}{4}$ " round iron control rod extends back to the driver's seat. The $1\frac{1}{8}$ " shaft is drilled for a cotter key which holds the assembly in the hanger. Washers are used as spacers, if necessary.

The brake block is made of three pieces of $\frac{1}{2}$ " bar iron. One piece is 10" long, one $11\frac{1}{4}$ " and one 7". They are welded to form a triangle. (See Figs. 2 and 4.) The dimensions given are for a 6:00 x 16 tire. For other sizes, the dimensions will necessarily be different.



Fig. 3. A view of the eccentric arm on the lift is shown on the cover. Details of construction are shown in Fig. 2.

The drum may be made by welding a 10" disk on one end of a 10" length of $2\frac{1}{2}$ " pipe. Another disk is welded 2" from the other end. This projecting end is threaded to take a $2\frac{1}{2}$ " coupling. This coupling is then welded to the hub of the wheel with its center in line with the center of the spindle. (See Cover and Fig. 2.)

The hangers must be made to fit the tractor on which it is to be used. For the Farmall H (Figs. 2 and 4), it was made of three pieces of $\frac{1}{2}$ " x 4" bar iron. Hanger A is made of one piece 17" long, one 4" and the other 18" long. The long piece is bent to fit the frame. An alternate hanger B is also shown in Fig. 2. A $1\frac{1}{8}$ " hole is drilled through the two long pieces to receive

the $1\frac{1}{8}$ " steel shaft. On other tractors, such as John Deere, and Allis-Chalmers, with straight side frames, it is more simple to place the hangers on each side of the tractor with the shaft long enough to reach across. The hangers are made of a piece of bar iron $\frac{1}{2}$ " x 6" x 14", as shown in Figs. 2 and 5.

The hangers and the brake are mounted on the tractor frame so there is about 1" clearance between the auto tire and the belt pulley when the wheel is against the brake. A light pull on the control handle pulls the auto wheel against the belt pulley. This causes the wheel and drum to turn and wind up the rope or cable. When the load is high enough, the pull on the handle is released and the weight of the load pulls the wheel forward against the brake.

To increase the lifting power and decrease the rate of lifting, rope blocks are used. The number of sheaves will depend on the load to be lifted. Two double blocks are commonly used on a sweep rake.

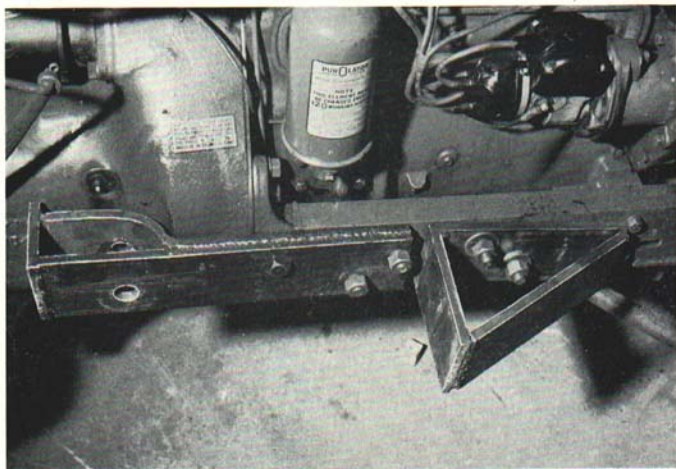

Fig. 4. The hanger and brake on the Farmall H with the wheel and spindle removed.

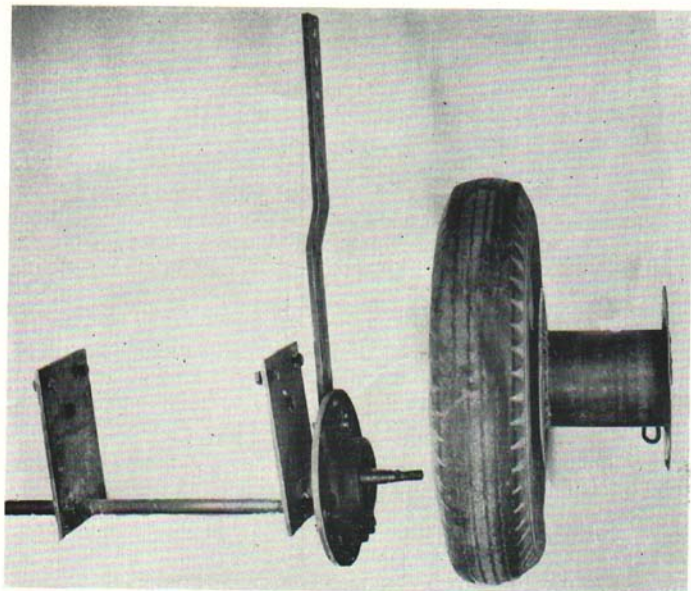

Fig. 5. Dismantled view of the lift shown on the cover. This type of construction is used on Allis-Chalmers, John Deere, etc.