

# Spartan

Michigan State College  
Library  
East Lansing, Mich.

# ENGINEER

## PERIODICALS

NOV 29 1950

MICHIGAN STATE COLLEGE  
LIBRARY

School of  
Engineering

☆

Michigan  
State  
College

☆

NOVEMBER, 1950  
VOL. 4, NO. 1  
TWENTY CENTS



# What Happens When 150,000,000 People Say: "I WANT!"

## THE STORY OF OIL



COLONEL Edwin Drake's oil well, drilled in 1859, produced only 20 barrels daily . . .

But it gave people a taste of the benefits of petroleum—and a great industry was off to a flying start!

The first drilling rigs—first refining equipment—were adequate for that early demand.

But invention of the automobile, airplane, Diesel engine and other great machines in turn demanded great invention in oil—and old-fashioned equipment gave way to scientific research laboratories, modern refineries, pipelines, tankers and tank cars.

*Each year demand made them bigger and better!*

Today, thousands of oil companies with oil fields, refineries, bulk plants, service stations and cost-cutting transportation systems—deliver over 1,840,000,000 barrels of petroleum yearly—meet U.S.A.'s demands for *value in oil*.

And, today, the responsibilities of Socony-Vacuum, one of the oldest companies in the industry, are constantly mounting . . .

Unprecedented demand for petroleum products calls for expansion in every phase of our efficient, coordinated operation . . .

46,400 independent "small" businessmen must be kept *competitive*—supplied with what it takes to provide a *big money's worth* for you—a good living for themselves.

When 150,000,000 Americans say, "I want," it takes businesses of all sizes to deliver!

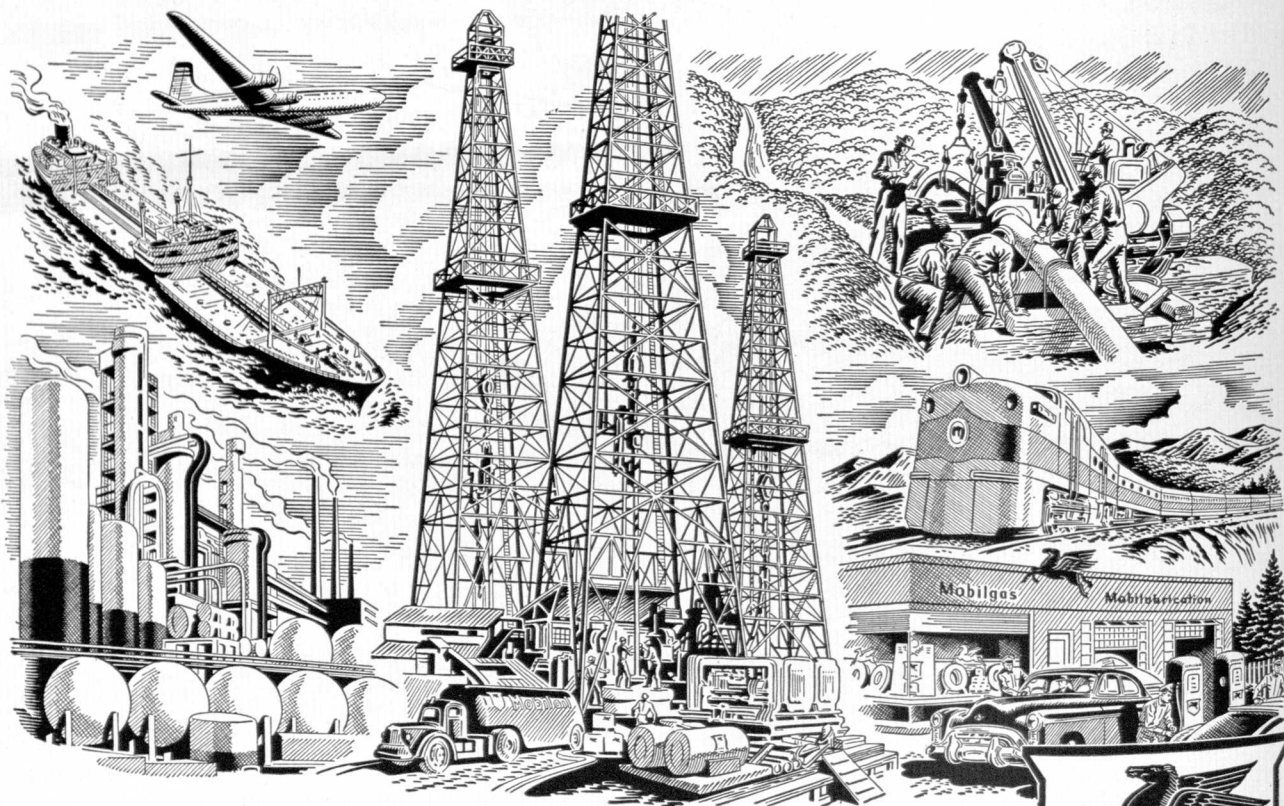

## DEMAND DETERMINES BIGNESS

The Flying Red Horse Companies

SOCONY-VACUUM OIL COMPANY, INC. • MAGNOLIA PETROLEUM CO. • GENERAL PETROLEUM CORP.



# CLOSEUP: *chemical plant 1950*

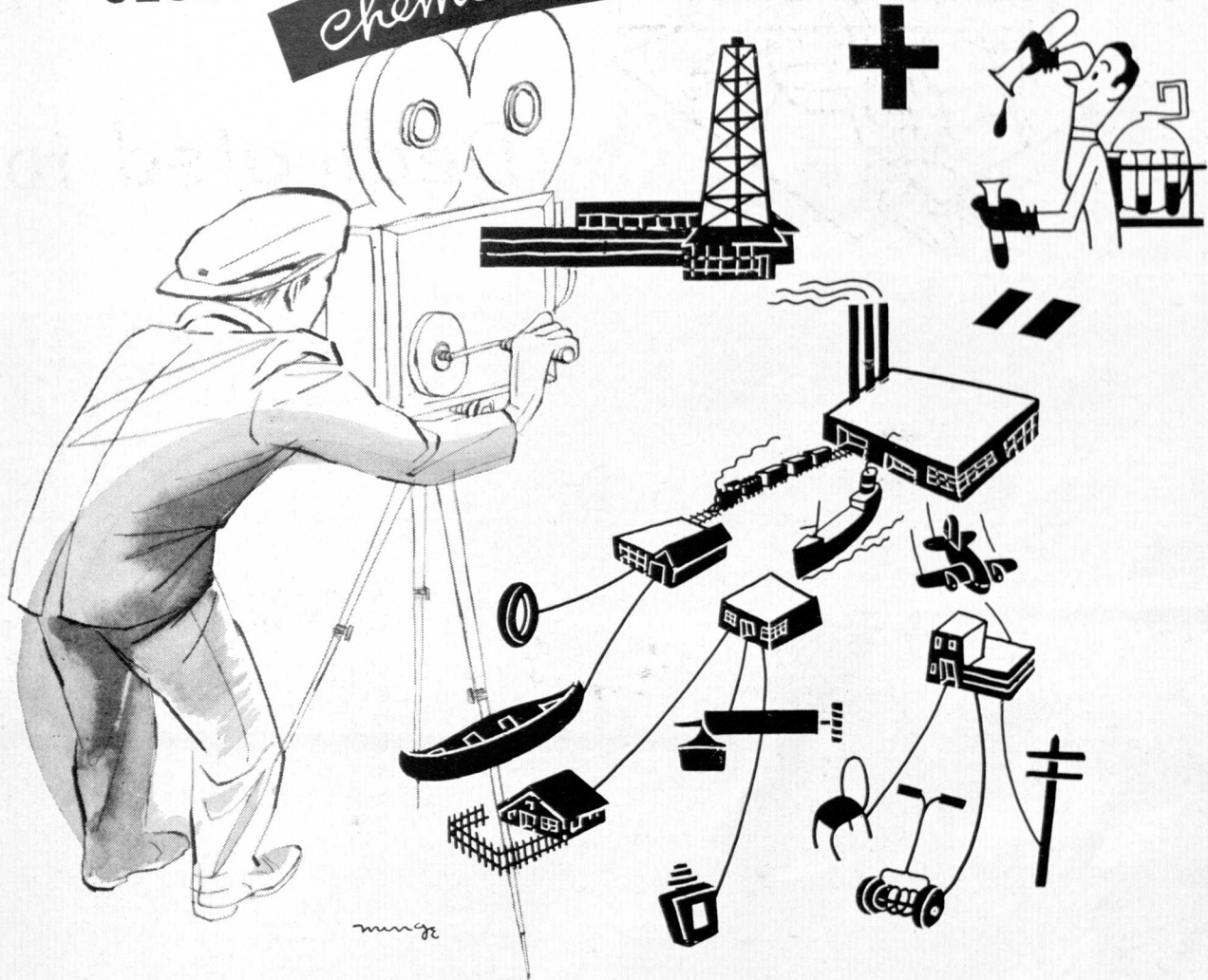

Ever take a close-up of a modern chemical plant in action . . . from research . . . through production . . . to the time the products are on the market? Let's take a look at Dow—one of the nation's leading chemical producers—by following just one product through the plant:

Dowtherm, for example, is a Dow-developed chemical for process heating. It brings accurate heat control and added safety not found in direct flame heating. Although Dowtherm is widely used already in many factory processes, Dow Technical Service and Research regularly aid in developing new applications for this outstanding Dow-developed heat exchange medium. Products now using Dowtherm in their manufacture include: nylon, plastics, varnish, vegetable shortening, soap, chemicals, asphalt, natural gas and fried noodles.

Once Dowtherm had proved itself in the laboratories, production took over to manufacture this important heat exchange medium for the processing plants of the nation. At the same time, the Dow sales department organized new service and distribution channels and gave special training to production engineers who would handle this new method for process heating.

Dowtherm is only one of over 600 Dow chemicals indispensable

to industry and agriculture. Multiply the complexities involved in researching, producing and marketing this one product by several hundred in the Dow line and you will understand why a close-up of a modern chemical company reveals one of the industrial achievements of the twentieth century.

**THE DOW CHEMICAL COMPANY • MIDLAND, MICHIGAN**  
 New York • Boston • Philadelphia • Washington • Atlanta • Cleveland • Detroit  
 Chicago • St. Louis • Houston • San Francisco • Los Angeles • Seattle  
 Dow Chemical of Canada, Limited, Toronto, Canada

**DOW**  
**CHEMICALS**

INDISPENSABLE TO INDUSTRY  
 AND AGRICULTURE

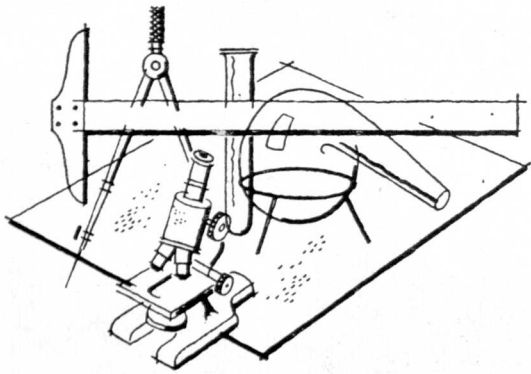

# Dedicated to

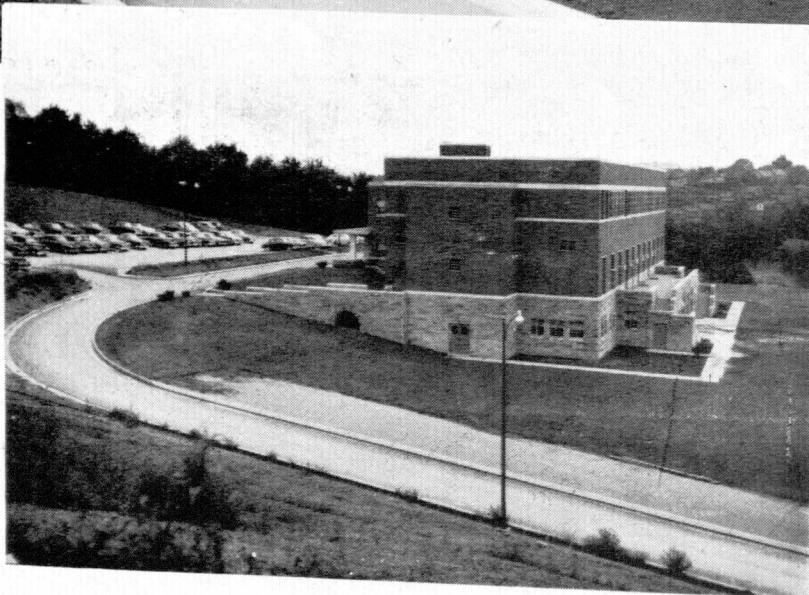

The new home of the Westinghouse Educational Center where new employees from engineering colleges receive an orientation and training program to help them find the kind of work they like to do and are likely to do best. Hundreds of experienced professional people help carry out this program. A Graduate Study Program is also made available through which advanced degrees may be obtained.

# A PRICELESS ASSET...

Building solidly for tomorrow is an important phase of modern business . . . building men for positions of leadership.

For more than half a century, Westinghouse has placed major emphasis on this activity . . . pioneering in student training . . . graduate study courses . . . encouragement of scientific training through scholarships and fellowships . . . and in many other ways.

Now we dedicate an entire new building to this purpose—the Westinghouse Educational Center—a building devoted to the self-improvement of men . . . dedicated to developing leadership.

Here, top students who are recruited at leading engineering schools for positions in engineering, manufacturing, sales and research, come for an orientation and training course that provides their first intimate view of the electrical manufacturing industry . . . and the varied opportunities it offers.

Every facility has been provided to help these men get off to a firm, fast start . . . mod-

ern class rooms equipped for visual education . . . a large auditorium with complete stage and projection room facilities . . . and a large, comfortable library and study hall. Here an intensive course of study is given by engineers and scientists who are top-ranking men in their fields.

These same facilities are also adequate to take care of the needs of post-training-course employees who are participating in the Graduate Study Program and the many other educational activities of Westinghouse.

For their convenience and comfort, there is a cafeteria and generous space for formal and informal gatherings. For relaxation and recreation, there are hobby, billiard and game rooms and outdoor recreation facilities.

Here, then, is a building dedicated to developing leadership . . . that priceless asset of a strong organization . . . able management and professional leadership for tomorrow. Another reason we say with confidence . . .

G-10116

**YOU CAN BE SURE..IF IT'S** Westinghouse

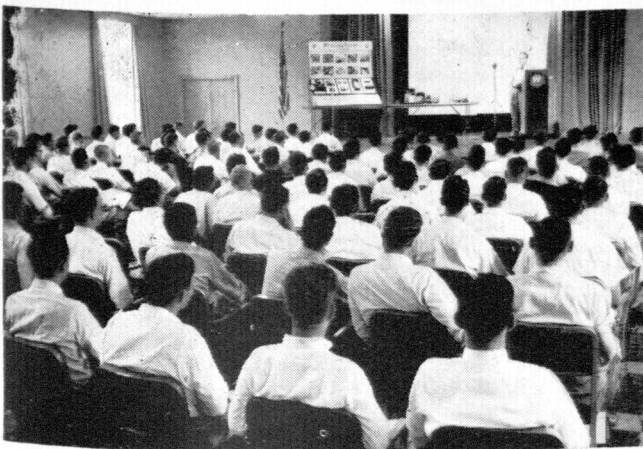

Aided by the most modern facilities, experienced professional people provide a panoramic view of the research, engineering and manufacturing that go into Westinghouse products and the techniques used in marketing them.

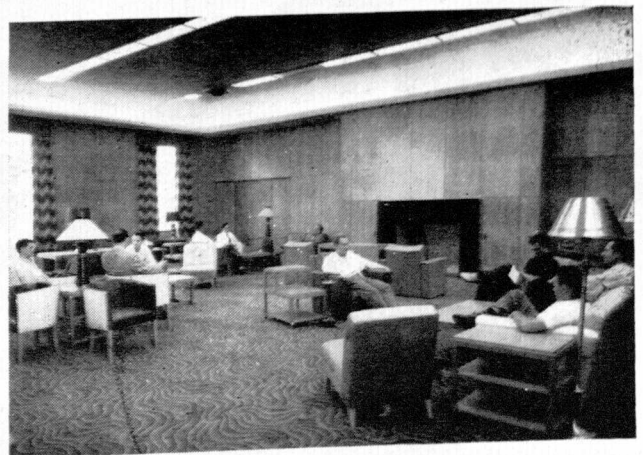

In planning the new Educational Center, careful thought was given to recreation. A spacious lounge, hobby and game rooms, a billiard room, facilities for indoor and outdoor sports along with a convenient cafeteria—all contribute to a well-rounded program.

# CRUSHING STRENGTH



## Strength factors of Long Life!

*No pipe that is provably deficient in any of these strength factors should ever be laid in city streets*

**W**ithout crushing strength—or, for that matter—without all of the strength factors listed opposite—no pipe laid 100 years ago in city streets would be in service today. But, in spite of the evolution of traffic from horse-drawn vehicles to heavy trucks and buses—and today's vast complexity of subway and underground utility services—cast iron gas and water mains, laid over a century ago, are serving in the streets of more than 30 cities in the United States and Canada. Such service records prove that cast iron pipe combines all the strength factors of long life with ample margins of safety. No pipe that is provably deficient in any of these strength factors should ever be laid in city streets. Cast Iron Pipe Research Association, Thos. F. Wolfe, Engineer, 122 So. Michigan Ave., Chicago 3.

### CRUSHING STRENGTH

The ability of cast iron pipe to withstand external loads imposed by heavy fill and unusual traffic loads is proved by the Ring Compression Test. Standard 6-inch cast iron pipe withstands a crushing weight of more than 14,000 lbs. per foot.

### BEAM STRENGTH

When cast iron pipe is subjected to beam stress caused by soil settlement, or disturbance of soil by other utilities, or resting on an obstruction, tests prove that standard 6-inch cast iron pipe in 10-foot span sustains a load of 15,000 lbs.

### SHOCK STRENGTH

The toughness of cast iron pipe which enables it to withstand impact and traffic shocks, as well as the hazards in handling, is demonstrated by the Impact Test. While under hydrostatic pressure and the heavy blows from a 50 pound hammer, standard 6-inch cast iron pipe does not crack until the hammer is dropped 6 times on the same spot from progressively increased heights of 6 inches.

### BURSTING STRENGTH

In full length bursting tests standard 6-inch cast iron pipe withstands more than 2500 lbs. per square inch internal hydrostatic pressure, which proves ample ability to resist water-hammer or unusual working pressures.



# CAST IRON PIPE SERVES FOR CENTURIES



# Spartan

# ENGINEER

## EDITOR

CHARLES E. PAUL

## BUSINESS MANAGER

WILLIAM M. THROOP

## ASSISTANT EDITOR

Arnold V. Nelson

## ASSISTANT BUSINESS MANAGER

Elton H. Moore

## FEATURE EDITOR

Harmon D. Strieter

## NEWS EDITOR

Robert G. Kitchen

## PICTURE EDITOR

Emil Raulin

## CIRCULATION MANAGER

Ted Summers

## PUBLICITY

Melvin Sandler

## STAFF

Bruce Miller  
Robert E. Kuhn  
William A. Little  
Thomas Ginther  
William R. Guntrum  
Andrew Nester  
Doug Hamilton  
Eugene R. Highfield  
Stanley C. Bailey  
Robert Tappe  
Philip S. Lang  
David A. Fiet  
Richard H. Kraft  
Phil Sanford  
Thomas Lopker

COVER: Courtesy Westinghouse

## Table of Contents

### ● articles

SCINTILLATION COUNTER .....	7
LIQUOR IN SEWAGE.....	8
PROFESSIONAL ENGINEERING REGISTRATION.....	10
DISC DATA .....	12
PAN AMERICAN HIGHWAY.....	14

### ● features

ENGIN-EARS.....	6
THE SOCIETIES .....	16
WE PRESENT.....	17
NEW DEVELOPMENTS .....	18
PICTURE PAGE .....	22
CAMPUS NEWS .....	32
ALUMNI NEWS .....	38
SIDETRACKER .....	39



Published four times yearly by the students of the SCHOOL OF ENGINEERING, MICHIGAN STATE COLLEGE, East Lansing, Michigan. The office is in room 515 Electrical Engineering Building, phone 8-1511, extension 7119. Entered as second class matter at the Post Office in Lansing, Michigan, under the act of March 3, 1879.

Address Mail to: P.O. Box 468, East Lansing, Michigan. Publishers representative  
Littell-Murray-Barnhill, Inc.  
101 Park Avenue, New York.  
605 W. Michigan Avenue, Chicago.  
Subscription rate \$1.00 per year.  
Single copies 20 cents.

# Engin - Ears

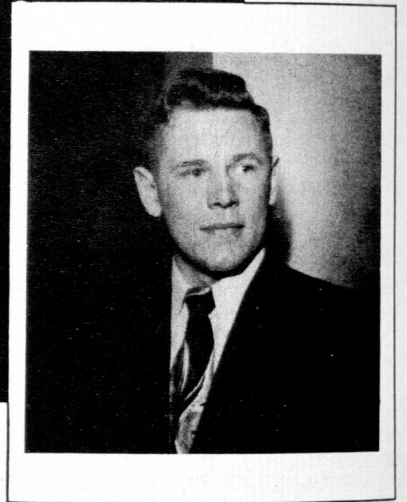

By Charles E. Paul  
Spartan Engineer Editor

This is the third year that the Spartan Engineer has been published. It has grown from a twenty-eight page magazine to one of forty pages. The staff had a nucleus of thirteen members which has been increased to more than twenty. An effort has been made to change the highly technical articles to ones having average technical terms. In this way it is hoped that all engineers can understand the articles and not only those in whose field it was written.

This magazine is printed four times a year by the students of the engineering school. It is printed for the students and alumni of Michigan State's College of Engineering. It is our aim to print the type of news and material that you would want to read.

One of the chief objectives is to keep our readers abreast of the industrial news and changes of science of this ever-changing world.

The only way a publication can achieve this goal is to have representation from each of the engineering departments. If there are any agricultural, chemical, civil, electrical, mechanical, metallurgical, or sanitary engineers that would like to help with this objective we welcome you to join the staff.

A television station permit has been applied for from the Federal Communication Commission. A TV studio is being constructed on the fifth floor of the Electrical Engineering Building. Equipment for the studio has been ordered and it will be installed as soon as the studio is completed.

The Amateur Radio Club has a message delivering service where anyone may send a message to any part of the U. S. and to some foreign countries. The Club has their transmitter located on the sixth floor of the E. E. Building.

C.E.P.



# SCINTILLATION COUNTER

## *An Instrument Superceding the Geiger Counter*

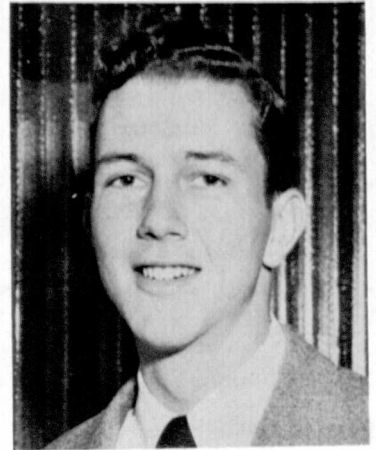

By Bruce Miller  
Junior, E.E.

**A** relatively new instrument is rapidly replacing the Geiger counter in many places where atomic and nuclear radiation is involved. This instrument, called a scintillation counter, can measure split-second flashes of light with much greater accuracy and speed by using a photoelectric "eye" and an electronic counting system.

The instrument has a fluorescent screen or phosphor crystal which will convert radioactive particles striking it into flashes of light. These flashes of light are sent into a multiplier phototube where they are converted into a greatly amplified electrical signal.



The phototube of this experimental scintillation counter is in the black tube at the left. The instrument at the right analyzes and counts the electric impulses.

**T**he electron tube is the heart of the scintillation counter and embodies developments made by Radio Corporation of America. It is a photoelectric eye which picks up the feeblest phosphorescent flash and converts it into an electrical current which is magnified as much as a million times before it is released to the counting mechanism of the instrument. The tube can count radioactive particles at the rate of one hundred million per second while the Geiger counter has a maximum count of 2000 per second. This is caused by a dead time of a few thousandths of a second after each count before it recovers and can detect another particle. This greatly limits its capabilities as compared to those of the scintillation counter.

**A** photocathode and a series of ten amplifying stages, or dynodes, are contained within the tube. A flash of light from the phosphorescent screen enters the tube and strikes the photocathode. A group of electrons are released by each electron in the light flash, and directed to the first amplifying stage where a shower of electrons is knocked off by each electron received from the photocathode. These showers

(CONTINUED ON PAGE 26)

# LIQUOR IN SEWAGE



By William Throop  
Junior, S.E.

This past summer research was conducted at the East Lansing sewage treatment plant by the M.S.C. Engineering Experiment Station to determine if waste pickling liquor could be used successfully in the treatment of sewage. The program was financed under the auspices of Guggenheim Brothers.

The method of treating sewage by the application of a coagulant agent augmented by return sludge in the presence of air is known as Guggenheim's Bio-Chemical Process. In this process the sewage first receives the accepted methods of primary treatment, after which the essentials of the Bio-Chemical are introduced. The primary effluent is passed into a tank for mixing by aeration. Into this tank a coagulating agent

is introduced, together with return sludge from the final settling tank. The sewage, coagulant, and return sludge are thoroughly mixed with air. The mixed liquor from the treated sewage is then delivered to a final settling tank where the settled sludge is removed and the clarified effluent discharged into a receiving stream.

The chemical coagulants usually used in the precipitation of sewage are hydrated ferric sulfate or alum. The use of pickling liquor combined with alum also has been used. The objection to these chemicals is the cost involved. The waste pickling liquor used this summer was obtained from the Oldsmobile drop forge plant for the cost of handling. Removal of scale and rust from castings by the 10% sulfuric acid pickling liquor produces from 6 to 50 pounds of iron as ferric hydroxide per 100 gallons of waste liquor. The ferric hydroxide is the active coagulant desired. The rate of application was varied from 2 to 4 parts per million or 16.68 to 33.36 pounds of iron per million gallons of sewage.

Various methods were used to pump the pickling liquor from the supply point to the aeration tanks. At first centrifugal pumps were used but the pump impellers soon became eaten out by the acid. The best method devised



Pumping the pickling liquor waste from the supply source to the aerators.

was a jet pump which could be regulated by a needle valve. All lines were of rubber or coated with an acid resistant paint. When the centrifugal pumps were used a header box was required to regulate the amount of dosage. The jet pump eliminated this piece of equipment.

During the month of August the treatment plant saved more than \$200 in electricity for the mechanical aerators by using the Bio-Chemical Process. The capacity of the plant was increased well over 100%. For a large plant the sewage could be treated for 2 dollars or less per million gallons.

**R**apidly growing cities have found their sewage treatment facilities inadequate to care for the increased loading. Also, expanding industries have added thousands of gallons of often unusually strong wastes to the domestic sewage. These increased loadings have necessitated either drastic plant enlargements requiring large capital expenditures, or chemical coagulation. Thus, many plants have chosen chemical coagulation.

Just as many sewage treatment plants are becoming rapidly overloaded and are thus unable to properly treat the incoming sewage, sludge drying facilities are likewise becoming overloaded. If sand drying beds are used, space is often unavailable for extensions even in those cases where the funds and materials are available. Consequently, the fastest and most economical means of sludge disposal must be sought in order to permit proper drying and to avoid unsatisfactory and often impossible lagooning. Michael A. Groen, Superintendent of Sewage Treatment for the city of Dearborn, Michigan discusses the use of waste pickling liquor for sewage sludge conditioning in his paper in the November, 1949 issue of "Sewage Works Journal".

**I**n conclusion, it is felt that pickling liquor waste is a very satisfactory substitute for more costly chemical coagulating agents. While expensive feeders are needed for most dry chemical coagulants, small amounts of inexpensive equipment, easily obtained, are needed for the use of waste pickling liquor.



The East Lansing Plant showing the Header Boxes feeding Pickling Liquor to the Aerators.

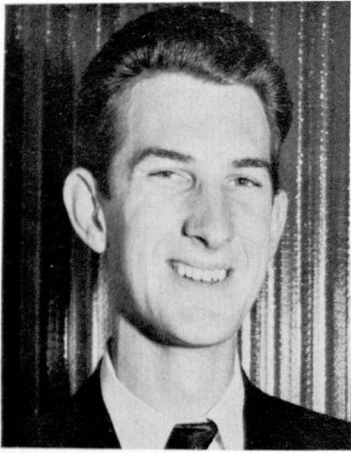

# P

# rofessionals

By Elton H. Moore  
Junior, E.E.

Each year a great many engineering students realize that although they have always intended to register they don't have any idea of how to start. We hope here to give some men at least a keystone from which to start.

First, before we start the procedure of registration, it might be well to know that in Michigan, registration is taken care of by the Michigan State Board of Registration for Architects, Professional Engineers, and Land Surveyors. This board consists of seven members and three administrative assistants. These seven members are appointed by the governor, one each year, for a term of seven years. During the last year of each man's term, he automatically becomes chairman of the board. Three assistants are regular employees of the State of Michigan who process and investigate all applications.

The first step in the registration of an engineer is the procurement of an application from the Secretary of the Board. This application, properly filled out, gives details of both education and experience, both of which are very important. Engineers are a proper combination of good education and responsible experience. The first part of the examination for student engineers isn't concerned with the amount of experience or with that particular field in which the applicant intends to practice. It covers the applicant's knowledge of the basic engineering subjects usually covered in the first two years of college.

The first part of the registration examination is given in two sections; one for the certificate of "engineer in training", and the other as part of the examination for the certificate of

"professional engineer" (principal qualification for which is eight years experience) he may take all three parts at once over a period of two days. However, if he can qualify only for the certificate of "engineer in training", passing this part of the examination exempts the applicant from taking part one again when he qualifies for the rest of the examination.

A few suggestions which may help the applicant receive more prompt attention to his application will now be given.

It doesn't pay to be modest in filling out the application; on the other hand, exaggeration doesn't do any good. While the application is the only way the board has of knowing the applicant's qualifications, the board will not accept the applicant's word as its only proof of ability.

In giving references, it is preferable that those listed be registered professional engineers. Also, the applicant should write to the person listed as reference, mentioning the fact that his name has been used, and refreshing his memory as to when and where the association between himself and the applicant took place.

In reviewing some of the rejected applications, it has been found that the definition of acceptable experience has confused many applicants. To be accepted by the board, engineering experience must be in a responsible position. Work as a designer, merely laying out prescribed specifications is not acceptable. On the other hand, executive responsibility is not required, as that usually takes many years to achieve.

This plan of examinations and a board of registration is set up in the

# Engineering Registration

State of Michigan by the legislature in Act 240, P.A. 1937 (as amended). Similar registration is now enacted in all 48 states, Hawaii, Puerto Rico, and Alaska. There is also a group active at the present time, which, realizing the faults of separate laws in individual states, is working toward uniformity in registration and the acceptance of a "model law". This law, revised in 1946, has already been approved by thirteen national engineering societies. Another group, National Bureau of Engineering Registration, has established a service to lessen the effort and expense of registered engineers interested in securing registration in more than one state. Anyone desiring further information should contact T. Keith Legare, Carolina Life Building, Columbia, South Carolina.

Opposition to registration by law has been voiced in the past, however, most of this opposition has recently decreased. One of the main reasons for this is set forth in Section 1 of the Registration Act, which reads as follows: "In order to safeguard life, health and property, any person practicing.... the profession of engineering, .... shall hereafter be required to submit evidence that he is qualified so to practice and shall be registered as hereinafter provided; and it shall be unlawful..... to practice..... the profession of engineering in the state .... unless such person has been duly registered or exempted under the provisions of this act.

In order to cover any pertinent points we may have missed and for further clarification of many we have covered, we present a summary of the Rules and Regulations of the Board as contained in the Roster of January, 1947.

The board furnishes printed forms which must be used for all applications or they will be refused acceptance. The applicant may attach separate sheets of the same size to the form if there is not enough space for full application.

The applicant is required to submit the following information: Name in full, usual written signature, place and date of birth, citizenship, residence address, business address, occupation, membership in technical and professional societies, education, and a record of entire professional career. This record shall be concise but comprehensive and shall contain inclusive dates with names and addresses of the employers or clients wherever possible. The applicant shall furnish the names and addresses of at least five people, three of whom should be registered architects, professional engineers or land surveyors who are familiar with his experience. A member of the board cannot be used as reference. An applicant from another state seeking registration by "reciprocity" may be required to submit, in addition to the other information, exhibits of his work. These may be plans, specifications, papers, reports or anything which would be helpful to the board in determining the applicant's qualifications. An affidavit must accompany each application and no application shall be accepted which hasn't been certified.

Enclosed within each application must be the proper fees as stated in the application. If rejected, the applicant will be notified immediately, including the reasons for the rejection. The board will also consider additional evidence to substantiate claims for registration if sent in by the rejected

(CONTINUED ON PAGE 28)

# DISC

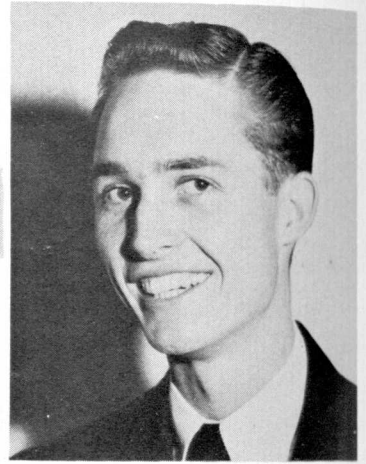

# DATA

By Arnold V. Nelson  
Junior, E.E.

**I**t was in the "Garden of Eden" that the first talking machine was heard. The only difficulty arising from this beginning was that it was found to be uncontrollable. It was not until 1877 that Thomas Alva Edison perfected the first controllable talking machine.

Basically, Edison's original model consisted of a brass cylinder wrapped with tinfoil. Mounted on either side of the cylinder were two instruments, the sound recorder and the reproducer. Each contained a mica diaphragm connected to a short chisel-like stylus or needle. Sounds introduced into the diaphragm of the recorder caused it to vibrate and the needle in turn forced

indentations into the tinfoil as the cylinder rotated. The process of reproducing the sound was just the opposite of the recording.

**S**ince the days of this first "phonograph" many revolutionary changes have been made. The major and perhaps the most important development was that of electric recording in 1925 by the Western Electric Company. Electric recording corrected such difficulties as bulky equipment and the inability to record the higher and lower frequencies of sound.

More recent developments in the disc field have taken place with the event of 33 1/3 and 45 RPM systems.

About 50 years ago the 78.26 RPM phono was developed. This speed was established wholly on an experimental basis having no definite speed as far as engineering design. It was decided upon after the mechanical spring wound motor was found to operate at 78.26 RPM. With this in mind both Columbia and RCA developed new systems of recording. Both companies wanted to improve the outdated 78.26 RPM system and in so doing the following changes were made.

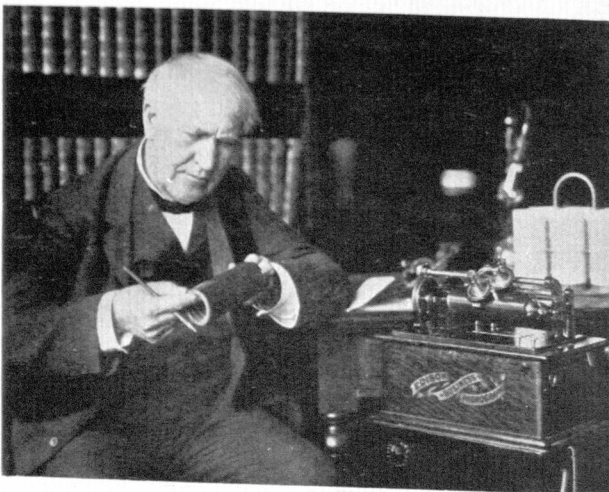

Thomas Alva Edison, Inventor of the "Talking Machine" is shown here examining the Wax Cylindrical Record of his 1907 Model Phonograph.

**T**he Columbia 33 1/3 system has the advantage over both the 78.26 and the 45 RPM discs in that it can play uninterrupted for approximately 25 minutes. The maximum playing time for

the conventional records and the 45's is about five minutes. As compared to the conventional disc which has 85 to 100 grooves per inch the 33 1/3 record has 224 to 300 grooves per inch. Further comparison shows that the tone arm applies only one-fifth of an ounce of pressure to the record. This means that care must be exercised in handling microgroove records as they will become scuffed even by the fingers touching the grooves.

The one great disadvantage of the 33 1/3 RPM system is that if 20 to 25 minutes of recording are used on one side, a large portion of the record has been used. In other words the area of the disc which has the actual recording is approximately the same as that on the 78.26 RPM records even though there are more grooves per inch. This in turn leads to the fact that there is going to be a considerable difference in the peripheral speed at the first groove as compared to that at the last groove. This difference leads to distortion.



The Berliner Gramophone, patented in 1887, featured a flat disc and a horn, in contrast to the cylindrical records then in common use.

The small 6.875 inch diameter of the 45 RPM disc, perfected by RCA through 10 years of engineering design, permits a small record changer. It also permits a decrease in the length of the tone arm thus decreasing its inertia. Having less inertia, the change cycle can be reduced to a minimum of 1.2 seconds, but a slight addition of time is allowed to insure changer reliability. This means that no speed reducing device is needed and the cycling cam may



In the Early Days, Musicians had to sit on crowded tiered benches so that all instruments would be in range of the Recording Horn.

thus be integral with the turntable.

The large 1.5 inch center hole provides a much simpler changing mechanism. The entire mechanism is contained within the center spindle. The center hole also provides a means of handling the disc without placing the fingers on the grooves.

The third and perhaps the most important feature is that the amount of inherent distortion is reduced to a minimum due to the selection of proper parameters. It was observed that in intermodulation distortion measuring below 10%, no aural distortion was perceptible. Such distortion was observed in the last third of high quality commercial records. To keep below this 10% figure, RCA has no terminal speed less than 11.5 inches per second on the innermost groove of the 45 RPM record. The parameters chosen gave a playing time of 5.33 minutes and 275 grooves per inch as the maximum.

Both the 33 1/3 and the 45 RPM make use of a much smaller needle point than that used by the conventional discs. The size is about .002 of an inch as compared to .006 of an inch for the standard needle. Both systems also make use of vinylite discs which have the advantages of flexibility and durability in addition to the elimination of record scratch. It was found that the mineral fillers in the shellac records was the principle cause of this scratching.

With these major changes in the recording industry already perfected, it is hoped that greater advancements to improve our listening pleasure will be made in the near future.

# Pan American Highway

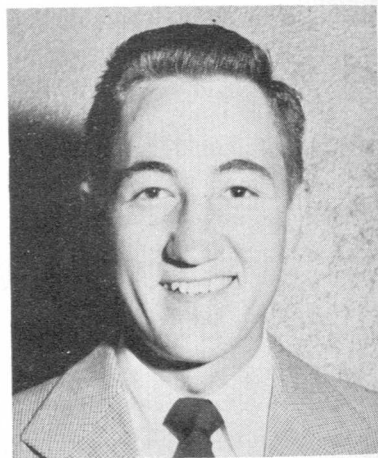

By Andrew Nester  
Junior, C.E.

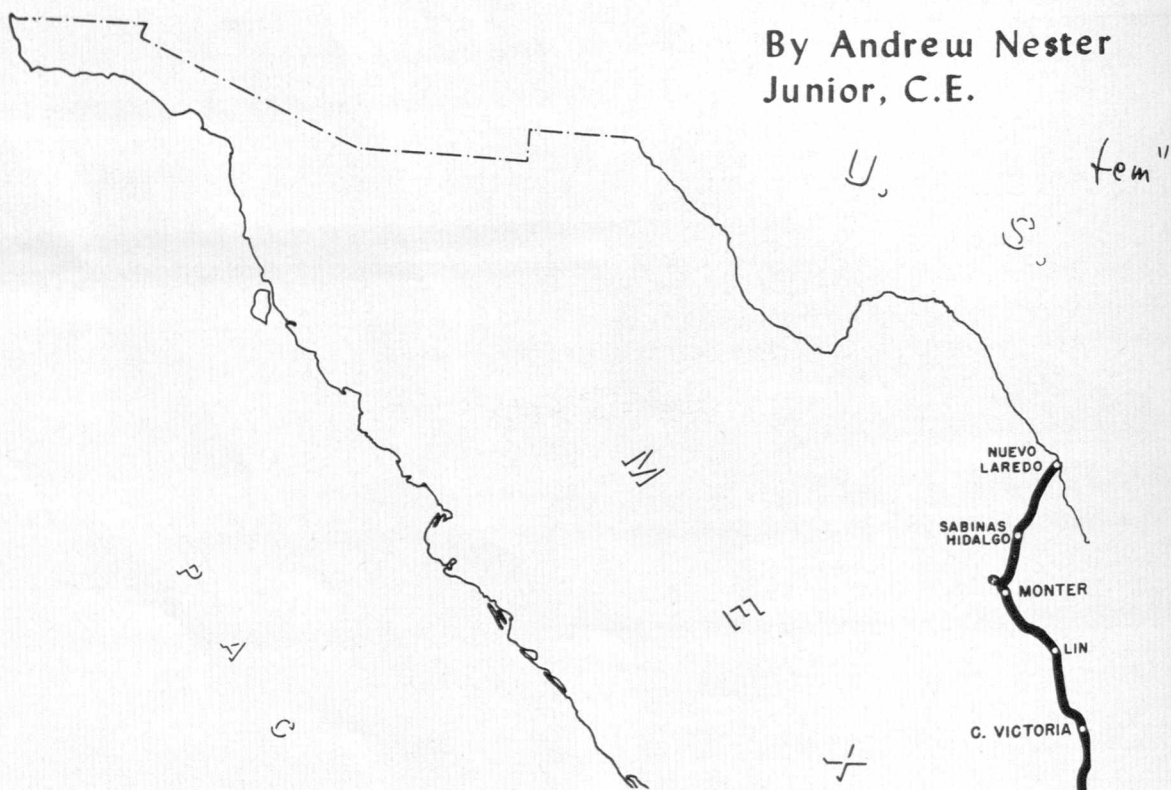

**T**axing all of the engineering principles of road building, the Pan American Highway System will be the largest road project ever to be undertaken. As in the Pennsylvania Turnpike the problems encountered were great, but even more complex because of the topography necessary to traverse. With the actual planning starting in

1924, surveyors have prepared the path of the proposed road from Fairbanks, Alaska to as far south as Puerto Montt, Chile. The designing of the system alone was a tremendous task. Many surveys and hypothetical relationships were first established to control factors such as geometric design, alignment, sight distance, consistency



and cost. Other influencing factors to determine the type and location of the road were the character of vehicles using the road, the theoretical annual average traffic, financing, and the policies of the countries through which the road would pass.

The Alcan Highway, not yet completed, runs through Canada and joins into the United States Highway system. Previous state and national highways connect the Alcan Highway with the Inter-American Highway; the Inter-American Highway being that portion through the five central American states. Going through the Isthmus of Panama, it continues along the west coast of South America and finally branches off into many of the South American countries. This integrated system formulates the Pan-American Highway System.

The Alcan Highway and the United States Highway Systems are being built with comparatively the average amount of planning. In Central and South America this is not the case as the topography encountered had very little penetration even from the natives. Presented here was the building of nearly 1600 miles of road through steaming, sea level jungles, pushing the slender thread of communication over swamps and deserts, across rivers never before bridged, and pinning it to the steep sides of forest covered mountains towering miles above the sea.

Cost of building the road ran high as the terrain was unusual to even some of the extreme conditions of roads already built. Elevations run from near sea level to 13,500 feet in some sections. For the purpose of continuity, much cutting and filling were required. Mountain ranges were prevalent and required tunnelling or rather extensive cutting.

Drainage is another problem that had to be contented with, especially in the near sea level sections where many swamps had to be worked through. Tile and stone drains were frequently used where unsolid ground was encountered with usual underdraining being used to intercept water flowing toward the road section. Culverts, for the purpose of conveying water through a road embankment, in some of the low areas, averaged approximately one for every five miles of road.

The complete project will require more than the usual amount of machinery, materials, etc. As an example let us take the rugged Talamance range where seventy-one miles of road had to be laid. Every month it required 100,000 pounds of asphalt. Men working in this section found it difficult to



South America - Showing Pan-American Highway.

Approximately two-thirds of the Pan-American Highway system, as now designated, has been so improved that automobile travel at all seasons of the year is possible. At present, travel is largely from farm to market or between towns and cities. Across-the-border travel between several countries is possible but impassable gaps and sections of the highway that can be traveled only in the dry season have prevented development of long-distance travel.

When completed, the Pan-American Highway System will connect the capitals of the republics of South and Central America with each other and with the highway systems of the United States. Looking at it from the engineer's standpoint it will be one of the greatest tributes to the civil engineering profession.

# The Societies.....

## AMERICAN SOCIETY OF CIVIL ENGINEERS



The first meeting of the school year was held in the Union. It was decided that all future meetings will be held every other Tuesday in the Union.

Treasurer Nyblade submitted his report and new members were instated.

## AMERICAN SOCIETY OF MECHANICAL ENGINEERS



At the first fall meeting the amount for membership dues was set for this year. Included with the membership is the "Mechanical Engineer", a monthly publication of the ASME.

A social committee was appointed to plan future parties. A meeting with the student chapter of the University of Michigan and the Detroit chapter of ASME is being planned.

## SOCIETY OF AUTOMOTIVE ENGINEERS



The following men were elected to office at the first meeting of fall term:

Ray Friend, Chairman  
Jack Fieblekorn, Vice Chairman  
Bruce Deyo, Treasurer  
Herb Mitson, Secretary

A series of talks is scheduled for future meetings. These will include "Fuels and Their Utilization", "Jet Engines", and "Automatic Transmissions". A trip to the Chrysler plant in Highland Park also has been planned.

## PHI LAMBDA TAU



Plans are being formulated by this honorary to have an initiation in the near future. Phi Lambda is a local honorary fraternity that selects its members from engineers who have demonstrated administrative ability and scholarship.

The officers for this year are:  
Fred Hyslop, President

Bill Throop, Vice President  
Ray Elliott, Recording Secretary  
Bob Kuhn, Corresponding Secretary  
Chuck Paul, Treasurer.

## AMERICAN SOCIETY OF AGRICULTURAL ENGINEERS



A large number of future agricultural engineers turned out for the first fall meeting. At this meeting Robert Greene, a graduate student working on his doctorate, talked on the parent organization of the A. S. A. E.

The faculty of the Agricultural Engineering department recently has given a dinner for all club members.

The officers this year are:  
Jerry Richards, President  
Jay Dunning, Vice President  
Don Florence, Secretary  
Bob Farmer, Treasurer  
Ross Brazee, Scribe

Of interest to other agricultural engineers is that the meetings are held in the club room, which is Room 7 in the Ag. Engineering Building. These meetings are held on the second and fourth Tuesday of each month at 7:30 P. M.

## AMERICAN INSTITUTE OF ELECTRICAL ENGINEERS INSTITUTE OF RADIO ENGINEERS



Fall term began with a membership drive and organizational meeting at which plans were mapped out for the coming school year.

Two very interesting Westinghouse movies have already been shown. One of our meetings was combined with that of the Round Table Group, Michigan Section, American Institute of Electrical Engineers. At this meeting, a highly informative talk, "Application of relays to power systems" was presented by Mr. Carl Asbury, Relay Application Engineer, Commonwealth Associates, Inc., Jackson, Michigan.

# WE PRESENT . . .

## MISS AGNES MC CANN

### ASSISTANT TO THE DEAN



By Robert Tappe  
Junior, E.E.

Hello fledgling engineers. Let's get introduced to a woman, who, unbeknown to you, is slated to play a rather prominent role in your future life at M.S.C. If your father happens to be an alumnus, the chances are that he and this charming (?) lady are well acquainted, because she has been on the scene at State since September 1, 1917.

Miss Agnes McCann (now remember the name and get acquainted) was born in Rives Junction, Michigan. After the completion of her schooling at Nazareth Academy in Kalamazoo, she came to East Lansing. Here she began the only employment she has known as Secretary to the Dean of Engineering College.

Then the Dean was G.W. Bissell, whom she remembers as one of the outstanding scholars in her association. It was Dean Bissel who encouraged her to pursue studies relative to her present occupation.

A partial list of her current activities include: Engineering representative to the All College Schedule Committee, Member of the Scholarship Committee, responsible for enrollment in the School

of Engineering, and college placement representative for engineers. Miss McCann also has the unique distinction of being the only campus woman member of Tau Beta Pi. This cherished honor was bestowed upon her by the national society in 1941.

A person who believes in keeping her student association on a friendly individual basis, Miss McCann is familiar with the names and records of the majority of her students both past and present. Recognition of individual students is a talent she has cultivated through the years. Aided by the snapshots she requests for her records, she cheers and astounds many by addressing them with their names upon first meeting.

The most difficult task connected with her various duties is telling the individual student "no",

and she intimates, "Some students think it is the only work I know."

In Miss McCann all M. S. C. engineers should recognize a friend, and as long as she remains here there will be at least one person who considers engineers, "The finest group on the campus."



MISS McCANN

# NEW

# Developments

## Electronic Torch

An electronic torch has been developed that is hot enough to cut holes in fire brick and melt tungsten.

The torch combines high-frequency radio signals and certain gases to produce temperatures that are greater than the melting point of tungsten. The heart of the torch is a tube known as a "magnetron", producing signals of one billion cycles per second. Leading from the tube is an antenna consisting of two concentric metal cylinders. A high-frequency arc is formed at the end of the antenna and if certain gases are fed past the arc, the electronic torch produces a jet of flame about nine inches long.

The torch works by the heat of formation of gas molecules. The arc breaks down nitrogen molecules into separate atoms and when these atoms strike a surface, they reunite and give off heat. Argon, helium and other inert gases give a flame with practically no heat. A torch using these gases would give off light, but a hand can be placed in it without ill effects.

## X-Ray Spectrogonimeter

X-rays now can be used to explore unknown substances, to determine what elements the substance contains and how the atoms in them are arranged.

The device used is known as an x-ray spectrogonimeter. The instrument makes use of x-rays, and especially sensitive "Geiger counter", and a system of gears machined to the accuracy of those used to control major astronomical telescopes.

The sample to be analyzed is mounted in the center of a table, which resembles a large knee-hole desk, with the x-ray tube, sample holder and Geiger counter mounted in the center of the top.

The manner in which a substance scatters x-rays is governed by the atoms it contains and the way they are arranged. The intensity of the x-rays and the angle at which they are scattered are recorded on a moving strip of paper. The record is marked off in the degrees of a circle through which the Geiger counter moves, and the x-ray intensities are indicated by the height of the line drawn by the recorder.

The method used by this new instrument is much faster and more accurate than the photographic method previously used.

## X-Ray Microscope

An x-ray microscope which makes visible the internal details of materials through which light cannot pass has been developed. This was disclosed recently at a meeting of the American Society for x-ray and Electron Diffraction.

Clear, sharp x-ray images, magnified ten times, have been produced in the laboratory. They have been enlarged many times by photographic methods without serious loss of detail.

The x-ray microscope may compete with the electron microscope in the future. It has an advantage over the electron microscope in that the specimen under study does not have to be placed in a vacuum.

The microscope operates on the principle that x-rays can be reflected, provided the rays strike the reflecting surface at a very small angle. It consists of basically of an x-ray tube, two curved mirrors, and a photographic plate. The mirrors and photo plate are enclosed in a compact metal unit about half the size of a shoe box.

After passing through the sample, the x-rays strike the mirror at an angle of less than one-half degree. The

mirrors bend and enlarge the rays to cast a magnified image on the photographic plate.

The mirrors are platinum-coated slabs of fused quartz ground as nearly flat as possible. They are then curved by mechanical pressure. This makes it possible to change the curvature of the mirrors in order to improve focusing.

The unit and photographic plate are mounted on a long wooden track which runs parallel to the x-ray beam. This arrangement enables the user to move both the optical system and the photographic plate.

## Indoor Sunlamp

Indoor sunlight is a possibility using a fluorescent sun lamp recently developed. Identical in dimensions and electrical operation with standard fluorescent tubes, the new sun lamp can provide a quick or gradual sun tan for a roomful of people.

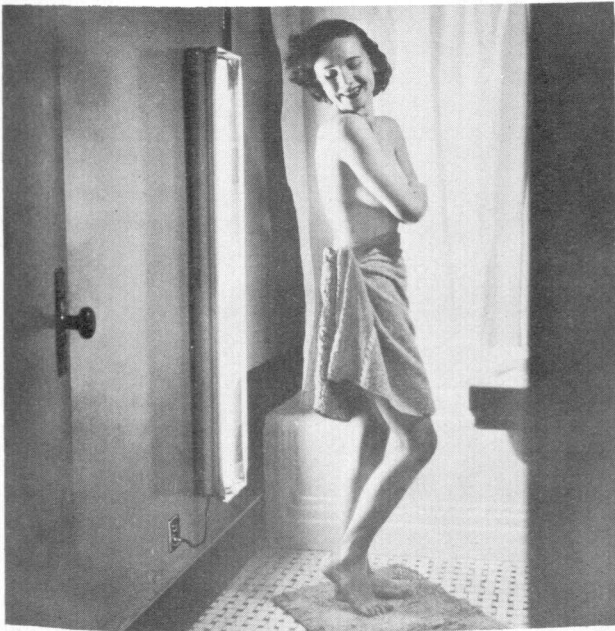

The life of the new device is more than 4,000 hours compared with the 1,000-hour life of present types. Elaborate starting and operating controls are eliminated and no warm-up time is necessary.

Because the surface of the tube remains cool to the touch, home installations similar to the one pictured are possible. The model pictured was used for demonstration purposes only and does not accompany each sun lamp.

## Turbosupercharger

A turbosupercharger which will enable commercial airliners, powered by internal combustion engines, to fly non-stop from Chicago to London with large payloads, has recently been developed by the General Electric Company.

Turbosuperchargers are the devices which enable airplane engines to "breathe" in the rarefied air of high altitudes. Spun by the engines exhaust, they compress the rarefied air to sea level pressures before it enters the cylinders.

This new supercharger, the CH9, has undergone rigorous test stand operation in combination with a Pratt and Whitney R-4360-C engine. Tests have shown 32 per cent more takeoff power, and a reduction of more than 20 per cent in fuel consumption, is possible with this combination as compared with transport powerplants now in use. The comparison was made with the performance of a powerplant consisting of a current production turbosupercharger, a BH-4, and a production R-4630 engine.

The CH9 turbo is said to supply the engine with the highest airflow - - 350 pounds a minute - - under greater pressure - - more than six times atmospheric - - than any turbosupercharger yet developed. This has resulted from aerodynamic design improvements in the turbo and advanced engine designs which permit operation of the turbosupercharger under higher exhaust pressures than previously possible.

The new supercharger entirely eliminates the conventional geared supercharger, or the impeller, operating off the engine shaft. There are no mechanical connections between the engine and turbo. Development of a direct cylinder fuel injection system for the R-4360 eliminated the major need for a geared supercharger which is used to insure uniform fuel distribution to the cylinders.

The elimination of the geared supercharger not only saves up to 500

(CONTINUED ON PAGE 30)

# Only STEEL can do so many jobs so well...

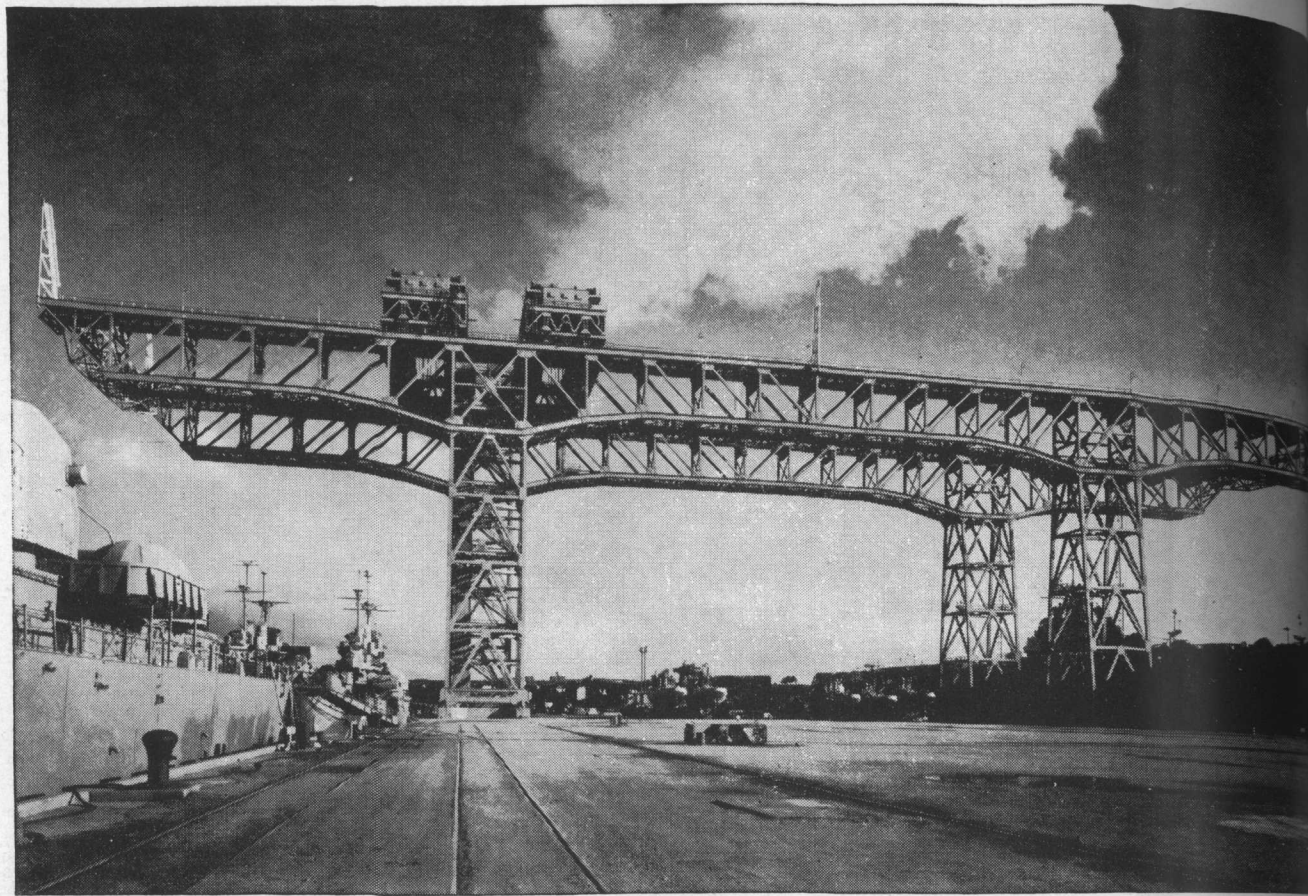

**HOW TO LIFT A MILLION POUNDS.** This crane runway, whose structure steel was fabricated and erected by United States Steel for the San Francisco Naval Shipyard, is 730 feet long, 209 feet high, extends 160 feet over the water at each side. It can lift gun turrets and other heavy sections weighing as much as 1,000,000 pounds.

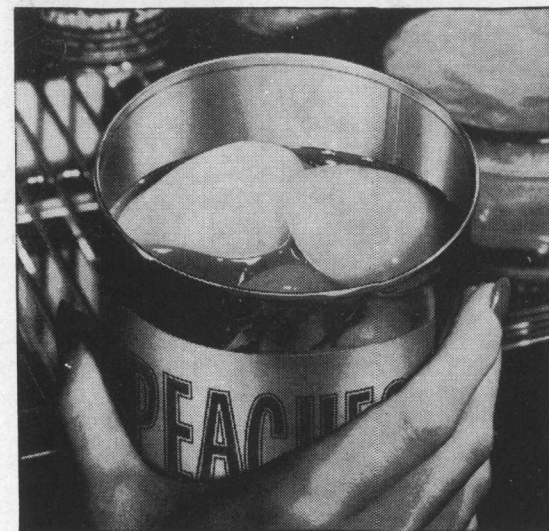

**CLEANER THAN YOUR BEST CHINA.** The inside of a food can is "surgically clean." Sterilized in processing, it is cleaner and safer than any dish. The Department of Agriculture reports, "It is just as safe to keep canned food in the can—as if the can is kept cool—as it is to empty the food into another container." And, incidentally, did you know that "tin cans" are really about 99% steel?

**THE SOFTEST THING YOU CAN SLEEP ON IS STEEL.** For solid comfort, you can't beat mattresses that have inner springs of steel. Especially if inner springs are made of U·S·S Premier Spring Wire, specially developed by United States Steel to give lasting resiliency and buoyancy to inner springs of sleep equipment and upholstered furniture.



**NEW ICE CREAM IDEA.** In certain parts of the country, you can now buy individually packaged single servings of ice cream. They're called "Diced Cream" ... and they strike a new high in sanitation, economy and convenience. Diced Cream is made in machines fabricated largely from stainless steel—to assure maximum purity in the finished product.

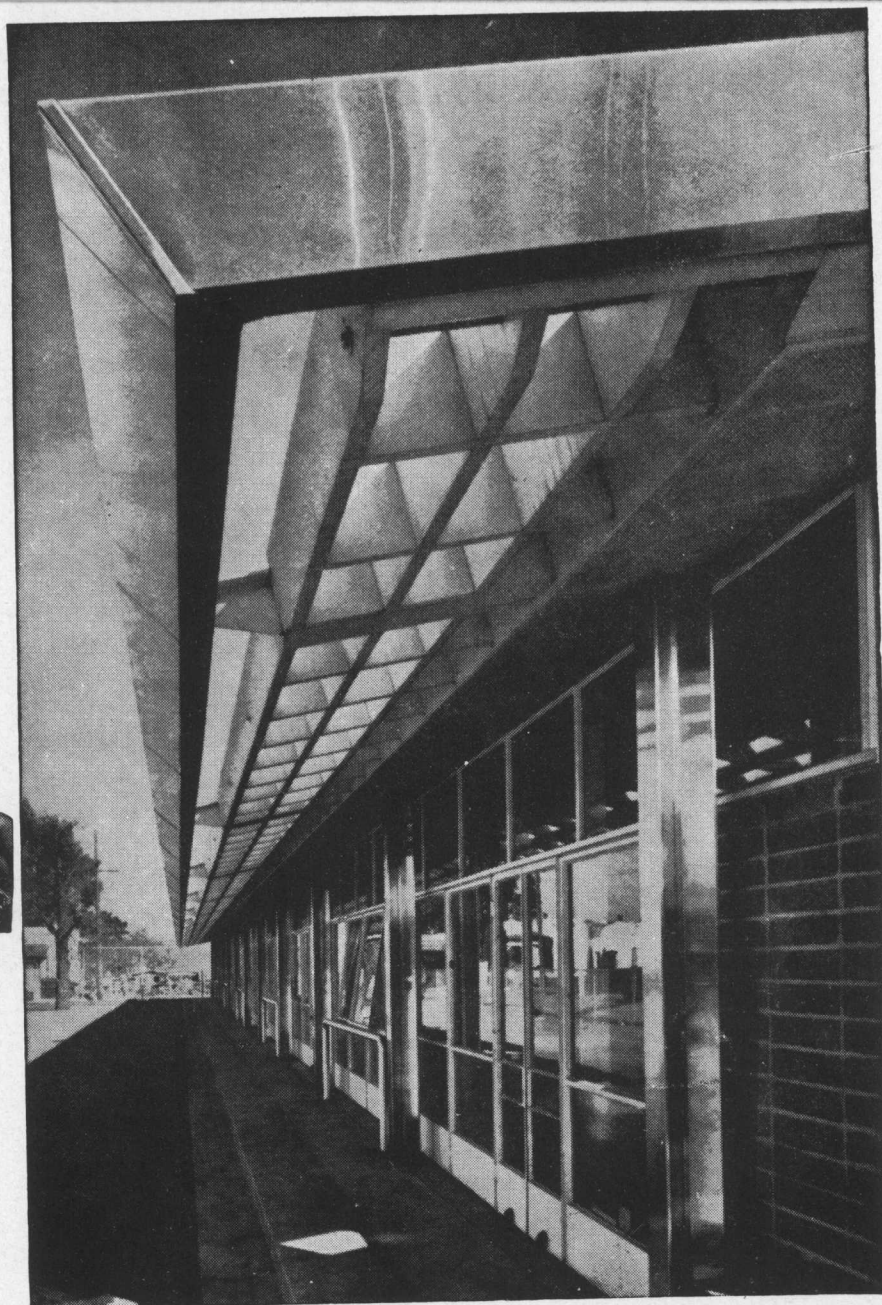

**STAINLESS STEEL GOES TO SCHOOL.** What a change from the little red schoolhouse! This new school in California embodies the latest features in school construction, including the use of U·S·S Stainless Steel for architectural trim. The stainless trim resists atmospheric corrosion, harmonizes with the building design. United States Steel produces steel of all kinds for such buildings ... continuing its number-one job of helping to build a better America.

Listen to ... *The Theatre Guild on the Air*, presented every Sunday evening by United States Steel, National Broadcasting Company, coast-to-coast network. Consult your newspaper for time and station.



... and this label is your guide to quality steel

## UNITED STATES STEEL

*Helping to Build a Better America*

AMERICAN BRIDGE COMPANY • AMERICAN STEEL & WIRE COMPANY • CARNEGIE-ILLINOIS STEEL CORPORATION • COLUMBIA STEEL COMPANY • H. C. FRICK COKE AND ASSOCIATED COMPANY  
 OLIVER IRON MINING COMPANY • PITTSBURGH LIMESTONE CORPORATION • PITTSBURGH STEAMSHIP COMPANY  
 UNITED STATES STEEL PRODUCTS COMPANY • UNITED STATES STEEL SUPPLY COMPANY  
 GENEVA STEEL COMPANY • GERRARD STEEL STRAPPING COMPANY • MICHIGAN LIMESTONE & CHEMICAL COMPANY • NATIONAL TUBE COMPANY • OIL WELL SUPPLY COMPANY  
 TENNESSEE COAL, IRON & RAILROAD COMPANY • UNITED STATES STEEL EXPORT COMPANY  
 UNIVERSAL ATLAS CEMENT COMPANY • VIRGINIA BRIDGE COMPANY

# ... PIC-CHORES ...

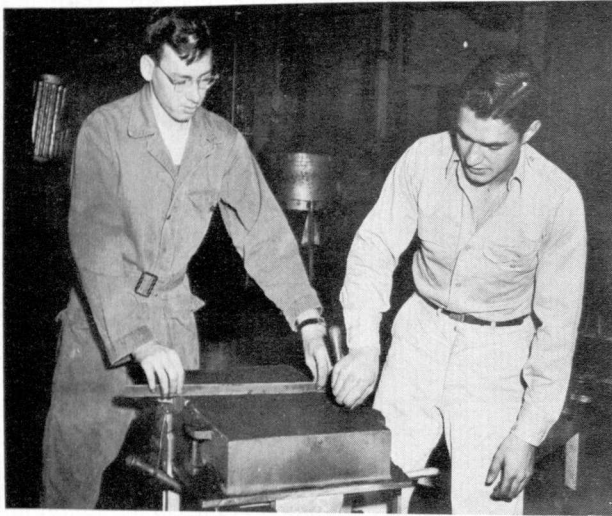

M.S.C. FOUNDRY - IDEAL WORKING CONDITIONS

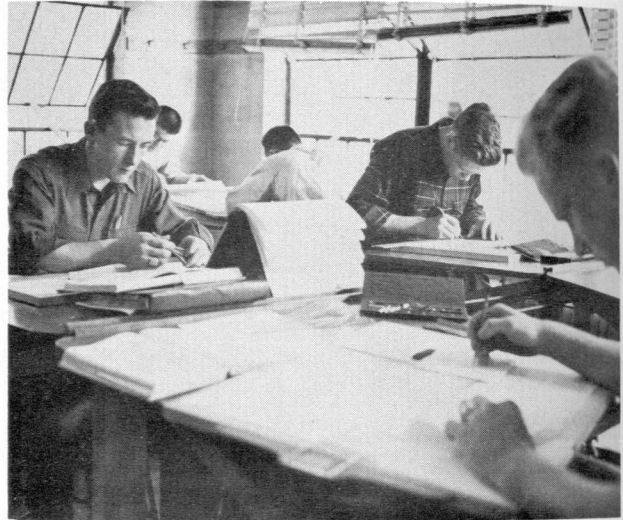

9 HOURS - 3 CREDITS - REMEMBER?

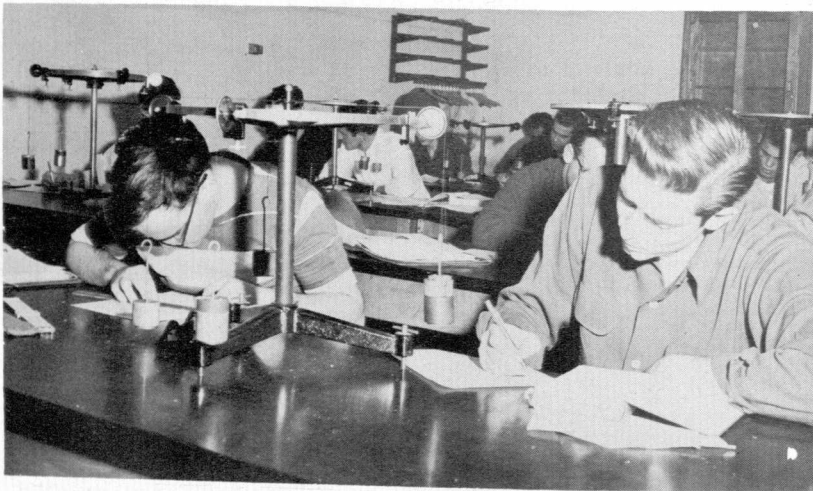

PHYSICS - SUM OF THE FORCES = 0

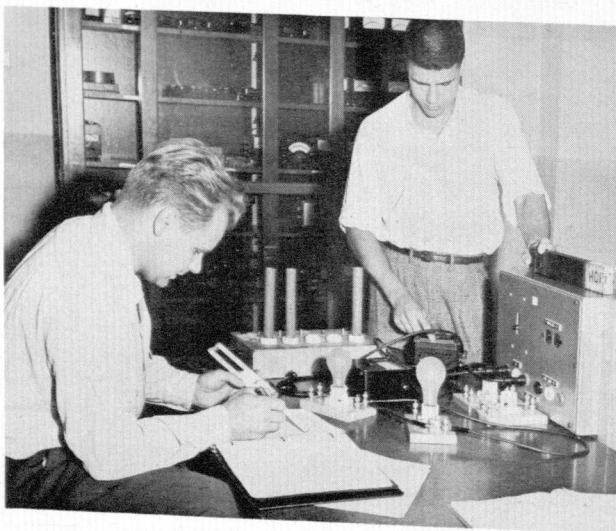

SHORT CIRCUITS LABORATORY

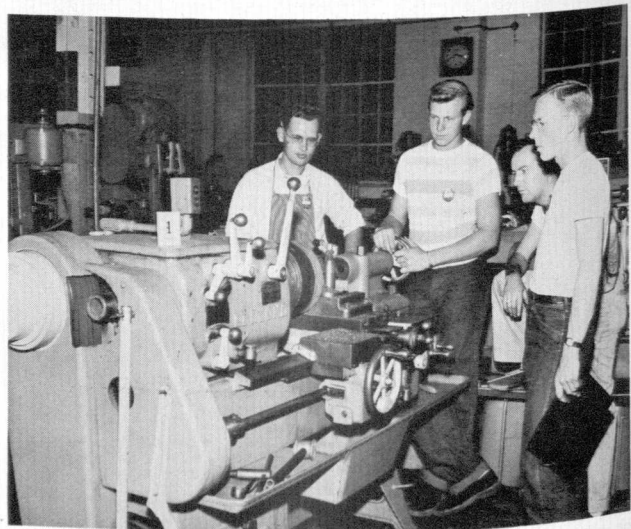

AIR COMPRESSOR PRODUCTION

# partners in creating

Engineering leaders for the last 81 years have made K & E instruments, drafting equipment and materials their partners in creating the great technical achievements of America. So nearly universal is the reliance on K & E products, it is self-evident that every major engineering project has been completed with the help of K & E.

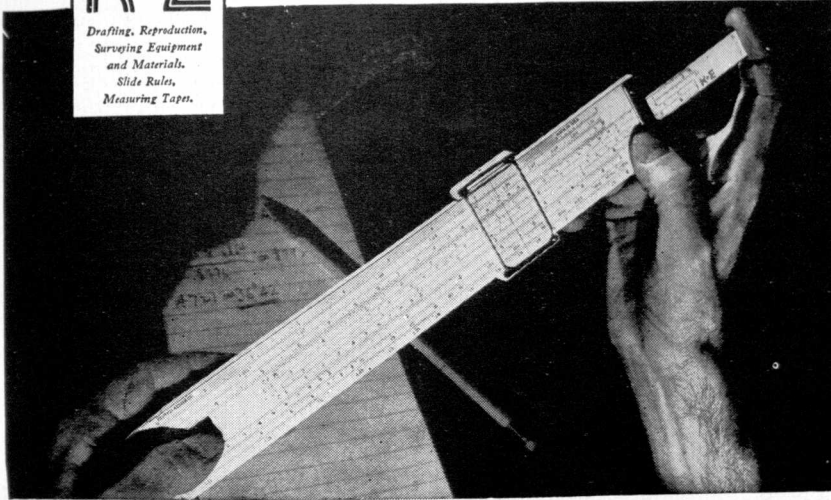

**KEUFFEL & ESSER CO.**

EST. 1867

NEW YORK • HOBOKEN, N. J.  
Chicago • St. Louis • Detroit  
San Francisco • Los Angeles • Montreal

JOBS FOR

# ENGINEERS

LONG HOURS

LOW PAY

INQUIRE:

Room 515

Electrical Engineering Building



You can

**AFFORD** to use

**CASTELL**

world's finest drawing pencil

with Genuine **IMPORTED**

**CASTELL lead now!**

Why wait until you graduate? Start using the Drawing Pencil of the Masters today—smooth, free-flowing, grit-free CASTELL, accurately graded in 18 unvarying tones of black, 7B to 9H.

YOU CAN AFFORD CASTELL—because it outlasts other pencils, hence is more economical. In addition, you get the personal satisfaction of superior craftsmanship that only CASTELL gives. Unlike ordinary pencils, CASTELL sharpens to a needlepoint without breaking.

Ask for CASTELL at your book store. Don't allow yourself to be talked into using a substitute. CASTELL is a life-time habit for up-and-coming Engineers.

**AW FABER CASTELL**  
PENCIL COMPANY

AW FABER CASTELL U.S.A. 9000 \* H \*



# LINDELL

Established 1910

**DROP FORGE COMPANY**

Incorporated 1923

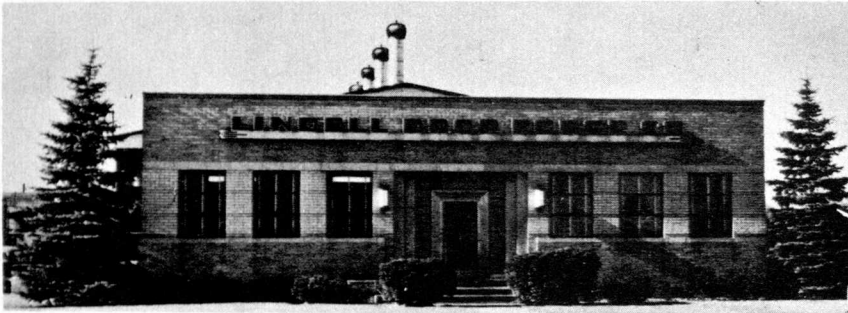

*Manufacturers of*  
**HIGH GRADE DROP FORGINGS**

2830 South Logan

Lansing 3, Michigan

Telephone 4-5403

## Modern power applications call for leather, too

There was something mighty impressive about those old-time woodshed sessions with Dad's leather razor strop. Dad had a very effective way of putting power to work via leather.

Here's the modern way to transmit power by leather in industry. The tension-control motor base puts the inherent power-carrying advantage of leather to work in compact space. The base plus the "single-pull" leather belt make a drive package that is "right" for many vital spots in today's industry.

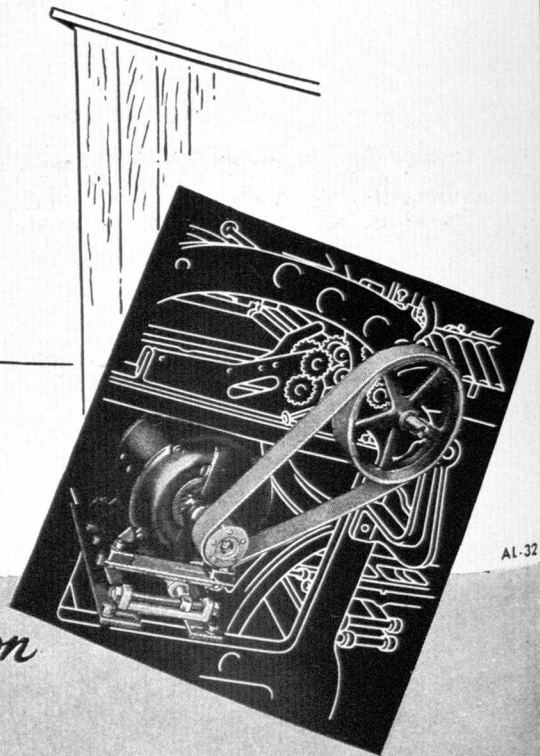

AI-32

*American* **LEATHER BELTING** *Association*

Headquarters for Authentic Power Transmission Data

41 PARK ROW, NEW YORK 7, NEW YORK

Another page for

# YOUR BEARING NOTEBOOK

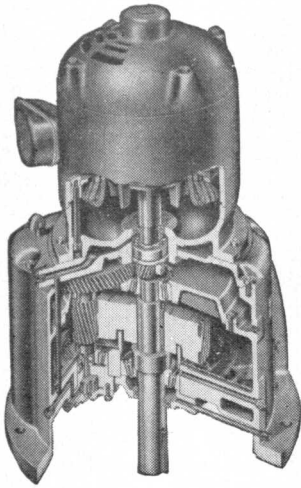

## How to help a gearmotor take care of its teeth

To minimize wear on the teeth and to insure smooth, quiet operation, reduction gears in motors like this must be held in perfect mesh, no matter what the load. That's one reason why engineers mount the gear shafts on Timken® tapered roller bearings. Timken bearings hold the shafts in accurate alignment. Gears are kept perfectly positioned, with each tooth meshing smoothly and carrying its full share of the load.

## Gears mesh smoothly, wear longer, with shafts on TIMKEN® bearings

Here is a typical gear-case countershaft showing a common method of mounting Timken bearings. Due to the line contact between the rolls and races, Timken bearings give the shaft maximum support. There's less chance of deflection under load. The tapered bearing design takes both radial and thrust loads in any combination. End-movement of the shaft is kept to a minimum. Gears wear longer—work better.

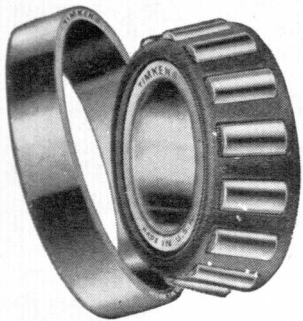
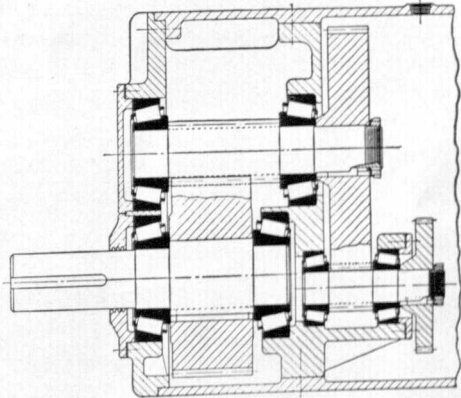

# TIMKEN

TRADE-MARK REG. U. S. PAT. OFF.

## TAPERED ROLLER BEARINGS

## Want to learn more about bearings?

Some of the important engineering problems you'll face after graduation will involve bearing applications. If you'd like to learn more about Timken bearings and how engineers use them, write today to The Timken Roller Bearing Company, Canton 6, Ohio. And don't forget to clip this page for future reference.

NOT JUST A BALL ○ NOT JUST A ROLLER ◯ THE TIMKEN TAPERED ROLLER BEARING TAKES RADIAL ⊙ AND THRUST ⊖ LOADS OR ANY COMBINATION ☼

# Scintillation Counter

Continued from page 7

of electrons are directed to the second stage where each electron knocks off another shower. After the process has been repeated at each dynode stage a veritable avalanche of electrons is released by the tenth dynode. These electrons constitute the electric pulse sent out by the tube.

Because of its high rate of counting the counter can detect such rapidly occurring events as the energy transitions of a nucleus and the decay of a meson.

The scintillation counter has other advantages over the Geiger counter in addition to the great amplification and the increased counting rate. By using suitable phosphor crystals it can detect all atomic radiations known today, even "soft" radiations such as alpha and beta particles and x-rays. Thin "windows" which are difficult to make are required by the Geiger counter to detect these soft radiations. As a contrast, the scintillation counter is rugged and stable, and has high efficiency.

The new RCA tube has a wide spectral sensitivity, covering the light spectrum from orange to the near

ultra-violet. Many phosphors, both organic and inorganic, respond efficiently to radioactive emissions in this portion of the spectrum. The field of exploration with the scintillation counter is being broadened by the greatly increasing number of phosphors which can be used with the new tube.



A Multiplier Phototube which is used in the Scintillation Counter.



ENGINEERS' CHOICE  
for ACCURACY and  
DURABILITY!

**LUFKIN**

**"WOLVERINE"  
CHROME CLAD  
Engineers Steel Tape**

**Assures A Longer Life Of More Accurate Measuring**

- Non-glare Chrome-Clad satin finish on line—extra durable, will not crack, chip, peel, or corrode.
- Super-strong rustproof metal disc reel with perforated sides to aid in cleaning and drying.
- Permanent jet black markings, prominent size aids easy and accurate reading—graduations extend to edge of line.
- Adjustable leather strap affords firm hold . . . long winding handle, line-locking type.
- Sturdy 1/4-in. line, fully subdivided, "Instantaneous" Readings . . . detaches and attaches easily to reel.
- Supplied with two improved pattern, removable finger rings. Ring locks under spring protecting first end.

In 50, 100, or 200-ft. lengths, marked feet, 10ths and 100ths, or feet, inches and 8ths . . . standard and extra-heavy models. See them at your nearest Lufkin dealer.

Buy **LUFKIN** TAPES • RULES  
PRECISION TOOLS

THE LUFKIN RULE CO. 95-A  
SAGINAW, MICHIGAN • NEW YORK CITY • BARRIE, ONTARIO

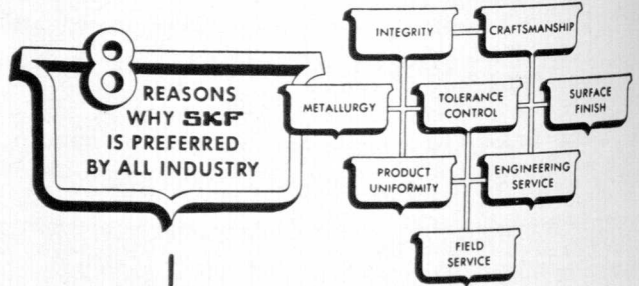

SKF Bearings are an integral part of complex machines. In many instances, SKF metallurgical skill resulted in the perfection of bearings with special ability to withstand tremendous stresses and strains . . . bearings which permitted the development of rolling mills, presses and the like that mean better steels more economically produced . . . serves all industry . . . everywhere.

SKF INDUSTRIES, INC., PHILA. 32, PA. 7063

SKF

BALL AND ROLLER BEARINGS



SPARTAN ENGINEER

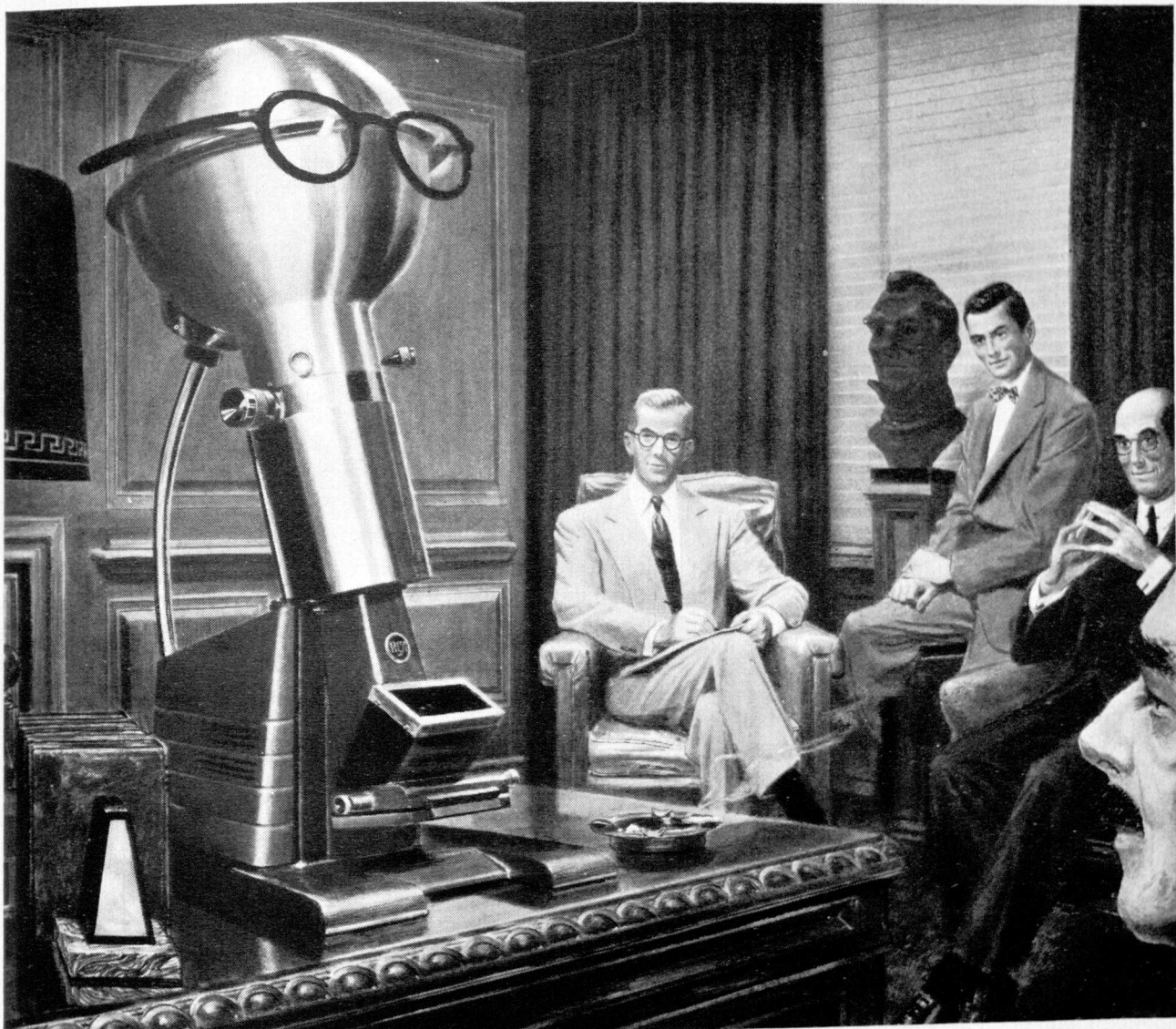

Portable electron microscope, developed by RCA, widens research in universities, industries, hospitals.

## The new instructor gets a hearty welcome

You've read, in both newspapers and magazines, about the powerful electron microscope. Now this amazing "instructor" of scientists, physicians, and engineers becomes even more useful—in more research fields.

Through principles uncovered at RCA Laboratories, RCA engineers have developed a compact "table model" electron microscope, at a price which makes it practical for use in an increased number of universities, industries, hospitals, clinics. So simplified is the new instrument

that even a high school student or unskilled laboratory technician can quickly learn to use it!

Magnifications of 6000 times can be obtained directly in RCA's portable electron microscope—four times that of ordinary light microscopes—and photography lifts this to 30,000! A new "instructor," yes—and one that gets a very hearty welcome.

\* \* \*

See the latest wonders of radio, television and electronics in action at RCA Exhibition Hall, 36 West 49th Street, New York. Admission is free. Radio Corporation of America, RCA Building, Radio City, New York 20, New York.

### Continue your education with pay—at RCA

**Graduate Electrical Engineers:** RCA Victor—one of the world's foremost manufacturers of radio and electronic products—offers you opportunity to gain valuable, well-rounded training and experience at a good salary with opportunities for advancement. Here are only five of the many projects which offer unusual promise:

- Development and design of radio receivers (including broadcast, short wave and FM circuits, television, and phonograph combinations).
- Advanced development and design of AM and FM broadcast transmitters, R-F induction heating, mobile communications equipment, relay systems.
- Design of component parts such as coils, loudspeakers, capacitors.
- Development and design of new recording and producing methods.
- Design of receiving, power, cathode ray, gas and photo tubes.

Write today to National Recruiting Division, RCA Victor, Camden, New Jersey. Also many opportunities for Mechanical and Chemical Engineers and Physicists.



**RADIO CORPORATION of AMERICA**  
World Leader in Radio—First in Television

# Professional Engineering Registration

*Continued from page 11*

applicant. Whenever additional evidence is submitted, the status of the applicant is considered to be as it was before rejection, and if the applicant is rejected as second time, he is prohibited from assuming any of the applied-for professional status.

All applications from candidates whether by examination or without examination shall be thoroughly investigated. The secretary shall inquire from the references concerning the accuracy of the information submitted or by such other means as the board may deem expedient. If replies from the references cited are not received within a

reasonable time, the applicant will be notified by the secretary that he should submit additional references. All information so obtained shall then be filed with the candidate's application as a permanent record which shall remain the property of the board.

Applicants will be registered under one or more of the following titles: Architects, Professional Engineers, and Land Surveyors. Professional Engineers shall be classified under one or more of the following subtitles: aeronautical, civil, mechanical, electrical, chemical, mining, and marine engineers.

Copies of the law and answers to any further questions may be obtained by writing to the Secretary of the Board, 705 Cadillac Square Building, Detroit, Michigan.

..... **NEW No. 10N**  
**Cutter and Tool**  
**Grinding Machine**

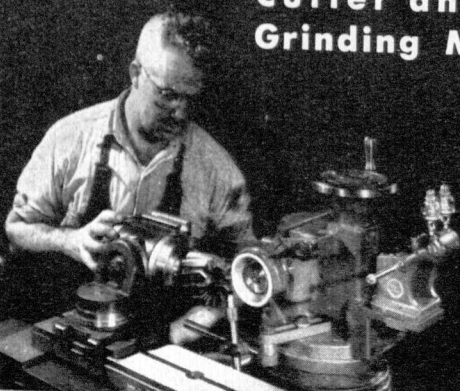

with **UNIVERSAL**  
 or  
**Plain**  
 Equipment

The new super-versatile No. 10N with Universal Equipment is especially designed for rapid, accurate toolroom work — light external and internal cylindrical grinding, surface grinding, as well as routine

sharpening. Also available with Plain Equipment for cutter and tool sharpening only.

Write for illustrated bulletin. Brown & Sharpe Mfg. Co., Providence 1, Rhode Island, U.S.A.

**BROWN & SHARPE** 

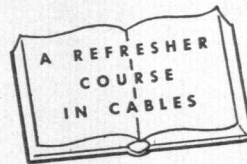

**THE SOURCE  
 OF A  
 RIVER  
 IS THE  
 SOURCE OF**

**QUALITY**...



From the headwaters region of the Amazon comes Up-River "Fine Para", widely acknowledged by rubber experts as the highest grade of natural rubber. To Okonite researchers and independent experts alike, long experience has shown that only this rubber provides all the factors needed in top quality insulation for electrical wires and cables.

The Okonite Company obtains a high degree of uniformity in shipment after shipment of this premium rubber in "biscuit" form . . . has found that Up-River Fine Para assures a long service life . . . uses it exclusively in all Okonite rubber insulated wires and cables. The Okonite Company, Passaic, New Jersey.

**OKONITE**   
 insulated wires and cables



## Why they put a glass pipe line underneath Buttermilk Channel

If you've ever driven through a long tunnel, you know how hard the lights are on your eyes.

The reason is you pass under a succession of bright spots of light which are apt to take your attention from the road. And you're made uncomfortable by the reflection of these bright spots from the top of the car ahead.

But New York's new 9117-foot Brooklyn-Battery Tunnel—America's longest, built and operated by the Triborough Bridge and Tunnel Authority—has an amazingly different and better kind of tunnel lighting.

Instead of the disturbing flicker of lights placed at regular intervals, motorists enjoy bright and even illumination—practically daylight—every foot of the way beneath Buttermilk Channel and New York Harbor.

The pipe line for this flood of light is built of 3000 twelve-foot sections of Corning's Pyrex brand glass tubing. Each length of pipe is a self-contained light cartridge, with two slim fluorescent lamps inside.

Should one of the lamps die out, that cartridge is replaced with another, assembled and kept ready on a repair truck. And replacement is made as easily as you'd pop a new bulb into a light fixture in your home.

The twelve-foot sections of Pyrex pipe are only two inches in diameter, with walls only a quarter of an inch thick. But despite their slimness, they're so strong they can withstand washing with a high-pressure hose. They're so sturdy they're not injured by truck tarpaulins which sometimes work loose and slap against them.

Designers of this new tunnel lighting system had no trouble finding a material needed

to make it work because, years ago, Corning developed heat-resistant Pyrex pipe for industrial use.

Throughout industry, *Corning means research in glass*—research that has helped make glass a material of practically limitless uses.

So, when you're out of college and busy planning new products or processes, or improvements in existing ones, it will pay you to keep glass in mind. Then we hope you will call on Corning before your planning reaches the blueprint stage. *Corning Glass Works, Corning, New York.*

**CORNING**  
means research in glass

## New Developments

*Continued from page 19*

hp, previously drawn from the engine, but also makes possible a more efficient method of cooling the combustion air going into the cylinders.

### Nothing Meter

Almost complete nothingness — man's nearest approach to a perfect vacuum — now can be accurately measured by an electronic pressure gauge 200 times more sensitive than any ever produced before. The super-sensitive gauge looks and behaves like a large radio tube.

Called an "ion gauge", the new instrument can detect the presence of air in a vacuum where only one air molecule remains out of every 10,000 billion originally present. So rare are air molecules at this pressure that each one must travel some 500 miles before striking another. Though scientists have gone this far in their search for a perfect vacuum, until now it has been impossible to measure.

This new instrument may prove to be the key to scientific investigation in many fields. For example, a better understanding of how gases seep through metals may be possible as a result of this new instrument.

To measure the pressure in a vacuum, the gauge is sealed tight to the system. Then the power is turned on and electrons from a "gun" inside the gauge are released, just as in a cathode ray. When these electrons collide with air molecules in their path, they knock off part of the molecule to create a positively charged particle called an ion. The number of ions formed in this way each second is an accurate measure of the pressure inside the vacuum system. Previous ion gauges were limited in their sensitivity because of false readings produced by x-rays inside the gauge.

A column of mercury whose height corresponds to pressure is used for ordinary low pressure measurements. At atmospheric pressure, the height is about 30-in. Using the new gauge, pressures that would raise a column of mercury only one-thousandth of a billionth of an inch can be detected.

(CONTINUED ON PAGE 32)

## DAIL STEEL PRODUCTS CO.

INCORPORATED 1913

*Manufacturers of METAL STAMPINGS  
AND ASSEMBLY WORK*

**LANSING 1, MICHIGAN**

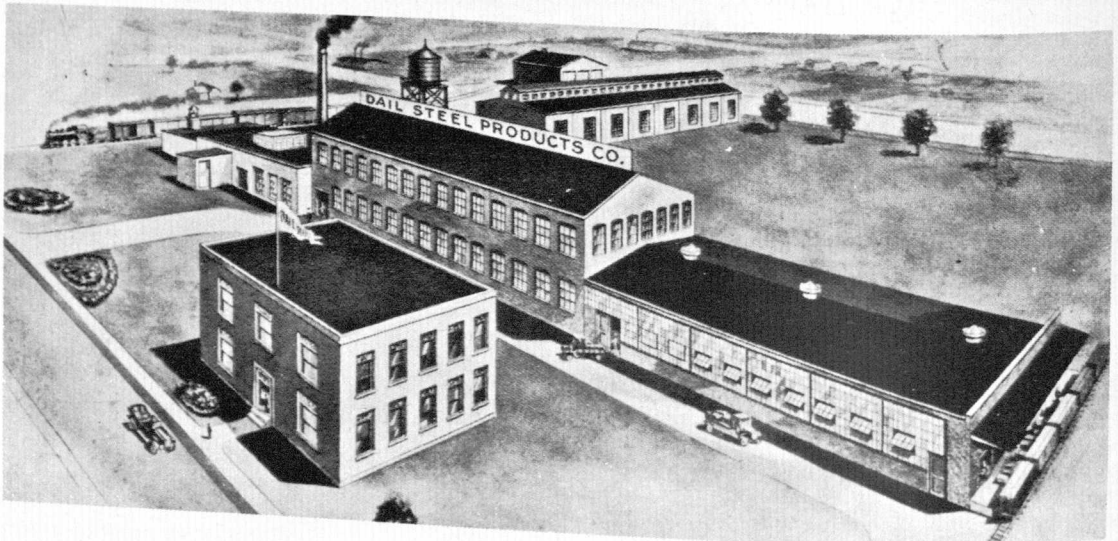

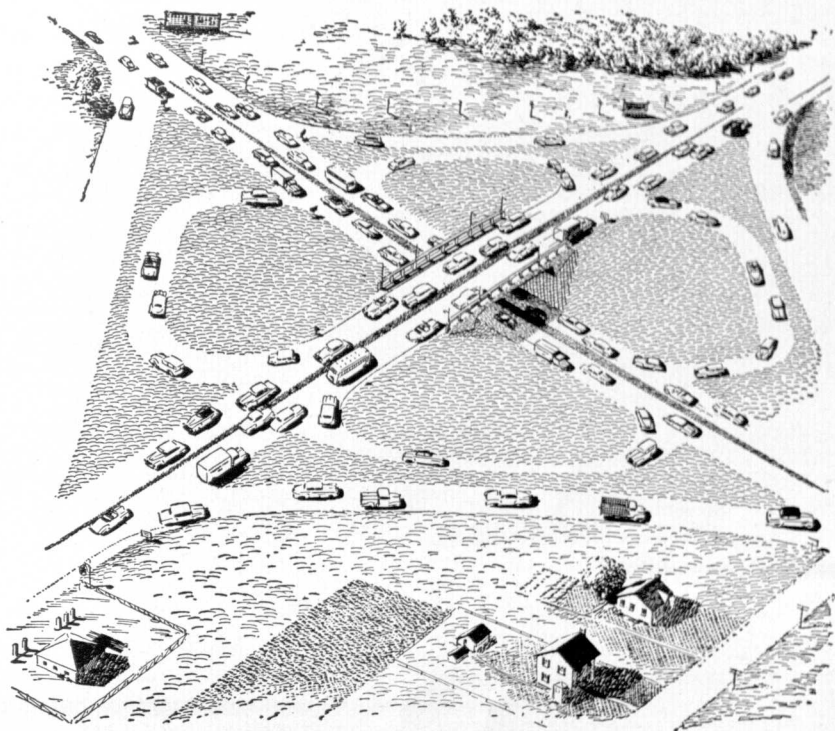

## The forgotten half billion



Roebling Aircord contributes importantly to safe, sure "control in the air".



Roebling Elevator Rope is the most widely used wire rope in elevator service.



Roevar Magnet Wire Insulation is 10 to 40 times tougher than other types.

IT'S EASY to forget a product that gives almost flawless performance. Most people, for instance, never think of the valve springs in their cars...largely because wire developments have brought them to a point approaching metallurgical and mechanical perfection. The half billion valve springs in service today...closing each valve as often as 12 times a second, from sub-zero temperatures to 400°F...will prove almost 100 per cent dependable for years on end. Roebling is a chief supplier of round spring wire to valve spring manufacturers.

Today, too, Roebling's wide line of wires and wire products offer economies to every field of industry. A full range of high carbon specialty wires...wire rope for every sort of rope-rigged equipment...more than 60 types of electrical wire and cable...a complete range of woven wire screens. Write for information about the Roebling products of interest to you.

EXTRA QUALITY...

EXTRA VALUE... THAT'S WHY

*Today it's Roebling!*

JOHN A. ROEBLING'S SONS COMPANY, TRENTON 2, NEW JERSEY

Atlanta, 934 Avon Ave. \* Boston, 51 Sleeper St. \* Chicago, 5525 W. Roosevelt Road \* Cincinnati, 3253 Fredonia Ave. \* Cleveland, 701 St. Clair Ave., N. E. \* Denver, 4801 Jackson St. \* Houston, 6216 Navigation Blvd. \* Los Angeles, 216 So. Alameda St. \* New York, 19 Rector St. \* Philadelphia, 12 So. Twelfth St. \* San Francisco, 1740 Seventeenth St. \* Seattle, 900 First Ave. So. A CENTURY OF CONFIDENCE





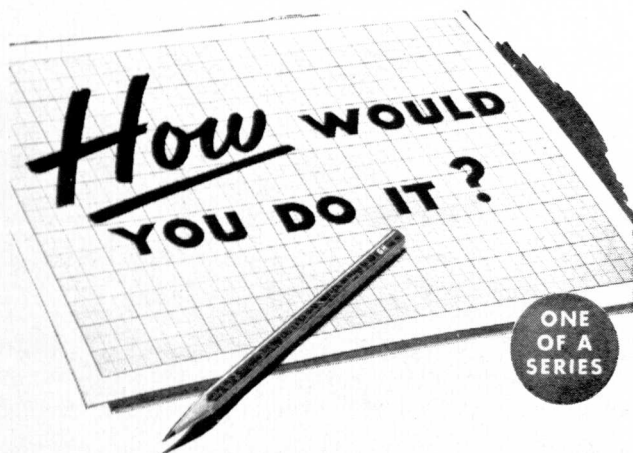

**PROBLEM**—Every so often, as the commutator segments of large motors wear down, the mica between them must be cut down. Your problem is to work out a tool which permits the undercutting to be done without removing the armatures from the motors.

**THE SIMPLE ANSWER**—An S.S.White power drive flexible shaft hooked up to an electric motor gives you the basis of a portable power unit for driving small rotary saws. A handpiece designed for mounting the saws finishes the tool. The illustration below shows such a unit made by the Martindale Electric Co., of Cleveland, Ohio.

The time and labor-saving advantages of having an easily manipulated power tool which can be brought to the work, can be readily appreciated. S.S.White flexible shafts make practicable the development of such tools for many purposes.



This is just one of hundreds of power drive and remote control problems to which S.S.White flexible shafts provide a simple answer. Engineers will find it worth while to be familiar with the range and scope of these *Metal Muscles\** for mechanical bodies.

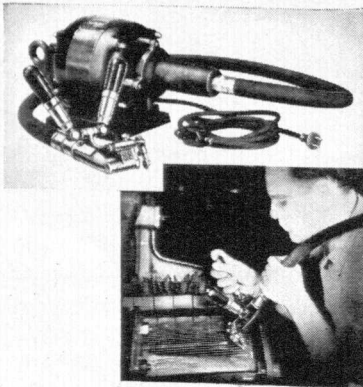

\*Trademark Reg. U. S. Pat. Off. and elsewhere

### WRITE FOR BULLETIN 4501

It gives essential facts and engineering data about flexible shafts and their application. A copy is yours free for the asking. Write today.



**S.S. WHITE INDUSTRIAL**  
 THE S.S. WHITE DENTAL MFG. CO. DEPT. C, 10 EAST 40th ST., NEW YORK 16, N. Y.



FLEXIBLE SHAFTS • FLEXIBLE SHAFT TOOLS • AIRCRAFT ACCESSORIES  
 SMALL CUTTING AND GRINDING TOOLS • SPECIAL FORMULA RUBBERS  
 MOLDED RESISTORS • PLASTIC SPECIALTIES • CONTRACT PLASTICS MOLDING

*One of America's AAAA Industrial Enterprises*

## New Developments

*Continued from page 30*

### X-Ray Plastic

A new plastic that can be made into scale models of machine parts and tools, now is providing "internal vision" for engineers in military, university, and industrial laboratories here and abroad.

First introduced more than a year ago, the new "photo-plastic" is aiding researchers in gun factories, airplane engine plants, arsenals, naval laboratories, and universities in the design of stronger machinery and equipment. The three-dimensional scale models cut from the plastic enable scientists to get a "portrait in color" of the strains encountered in tools, machine parts, and other objects. The plastic can be cast in cylindrical or rectangular chunks 8 inches in diameter or in width and 36 inches in length. Previous "photo-plastics" were limited to flat pieces not more than an inch and a quarter in thickness.

One of the major applications of the new material is in the design of breech blocks for big guns. To understand the terrific stresses these parts undergo during firing of the gun, an exact three-dimensional model of the block has been built and loaded to simulate the stress.

When frozen into the material and then viewed through special polarized light, the stress pattern appears as a series of vari-colored lines that tell where the major stresses are located, in which direction they are acting, and just how great they are.

Medical scientists may find the new material of great value because experimental leg-bone models have shown that internal stresses in human bone structure — such as those caused by fractures or heavy blows — can be clearly viewed and analyzed.

The new plastic is a modified form of Fosterite, the waterproof material developed during the war to seal radio and radar parts against moisture. This type Fosterite is 35 per cent more sensitive than the standard photo-plastic. As a result, many more stress lines appear when the model is viewed through polarized light. Since counting these lines is an essential part of analyzing the stress pattern, the more lines there are, the more accurate the diagnosis.

(CONTINUED ON PAGE 34)

# Build Confidence ON BROAD EXPERIENCE

by ARCH COOPER

Manager, Empire Region

ALLIS-CHALMERS MANUFACTURING COMPANY  
(Graduate Training Course—1909)

YOU NEED the confidence that comes from wide experience, whether you intend to be a salesman, designer, researcher, or production man. Confidence based on knowledge is one of the greatest assets an engineer can have. Here is what I mean.



ARCH COOPER

You may visit a mine with the idea of talking about crushing equipment, but find that their engineers have an electrical problem. Or you may visit a utility to talk about electrical equipment and find that they're all excited about a pump break-down.

## Offer All-Around Help

Can you help them? Or are you just another peddler who is taking their time when they have problems on their minds. In my work I call on electric utilities, cement plants, machinery builders, textile mills, paper mills, shoe factories and many other types of plants. In each of them, I try to help the engineers and mechanics I call on.

It's a good credo for salesmen, but it takes broad experience to carry it out. It's the kind of experience you must deliberately set about acquiring as early as possible. I had heard of Allis-Chalmers equipment, seen A-C's giant Corliss engines in Australia's biggest power plant and de-

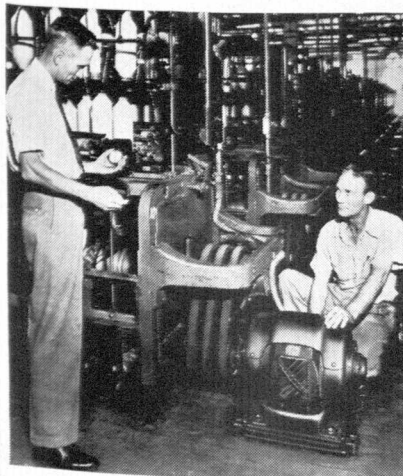

Textile mills are getting adjustable speed at lower cost by using new automatic Vari-Pitch sheaves on spinning frames as shown.

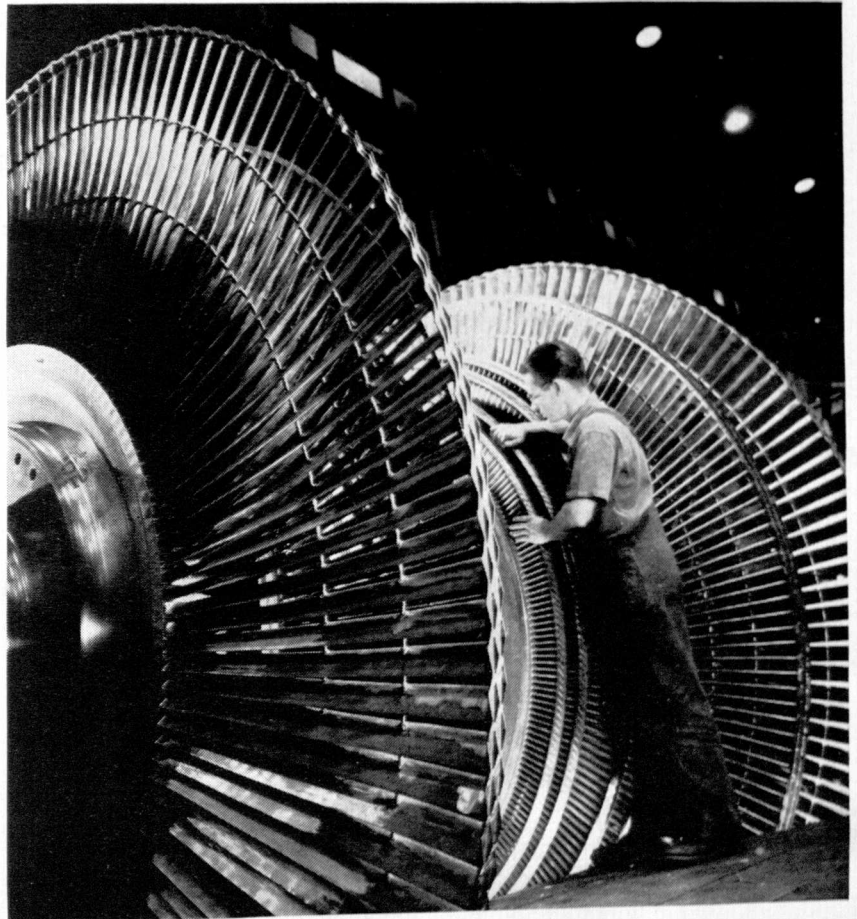

High temperatures and speeds raise tough design and production problems on giant steam turbine spindles like these.

cid to study design at Allis-Chalmers. It looked like the best place in the world to get a broad engineering background.

I joined the Allis-Chalmers Graduate Training Course after graduation from Sydney Technical College in 1908 . . . worked on steam turbines, wound coils of all types, performed tests for the electrical department. After that there were field trips to erect electrical equipment. It was soon apparent that I wasn't a designer at heart, and my sales career started.

## Broad Opportunity

Forty-one years later, Allis-Chalmers still offers the same opportunity for broad experience. A-C still builds equipment for

electric power, mining and ore reduction, cement making, public works, pulp and wood processing, and flour milling.

And the Allis-Chalmers Graduate Training Course is still flexible. Students help plan their own courses. They can switch to design, manufacturing, research, application, sales, or advertising—divide their time between shops and offices—and can earn advanced degrees in engineering at the same time.

Men at Allis-Chalmers get a close-up of the basic industries. No matter what path they take in the industrial world, experience gained with this broad organization lays a foundation for the confidence that comes with all-around knowledge.

# ALLIS-CHALMERS



Allis-Chalmers Manufacturing Company, Milwaukee 1, Wisconsin

# New Developments

Continued from page 32

## Gas Turbines

When experiments proved the gas turbine to be practical for the propulsion of aircraft, the aircraft industry looked at a future of higher and faster flight.

Three basic forms of gas turbines are presently being used in aircraft. The turbo-supercharger, enabling internal combustion engines to fly at high altitude by compressing the rarefied air, was first. The compressor on this device is driven by the engine exhaust.

The turbo-supercharger was employed in many World War II aircraft. Modern military aircraft such as the "Convair" B-36 and the Boeing B-50 are supercharged. Using superchargers on the Boeing "Stratocruiser" is the first commercial application.

The second of the gas turbines was the turbo-jet which is used to power jet aircraft. The Bell P-59 "Aircomet" was the first jet-propelled aircraft in this country. Since the first flight many

records have been established by jet powered aircraft. One of the records is the 3 hour, 46 minute coast-to-coast run made by the Boeing XB-47 bomber. This bomber was powered by six turbo-jets.

The third form of gas turbine is the turbo-prop; a propeller-driven gas turbine.

Considering the difficulty of the problems that the metallurgists and designers must face, a great deal of progress has been made in the development of the aircraft gas turbine. In spite of high operating temperatures, high rotating speeds, plus the necessity of minimum weight, the power output per pound has been tripled. At the same time, operating efficiencies have been increased 40 percent or more and the service life has also been greatly increased.

Many of the countries best engineers have devoted their time to research and design of this new form of aircraft power unit. In addition, the Air Force and National Advisory Committee for Aeronautics are concentrating their facilities on gas turbine research.

# DISTEL HEATING COMPANY

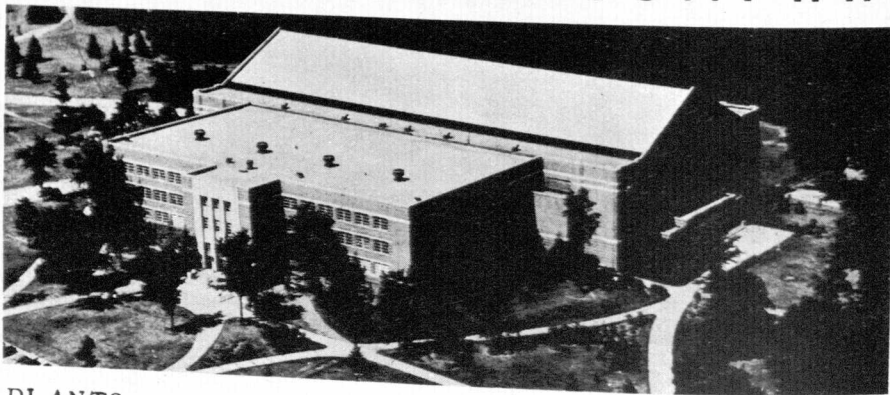

POWER PLANTS  
REFRIGERATION

PLUMBING  
SPRINKLING SYSTEMS  
INDUSTRIAL PIPING

AIR CONDITIONING  
HEATING

Established 1922  
720 E. Shiawassee St.  
P. O. Box 298

LANSING

MICHIGAN

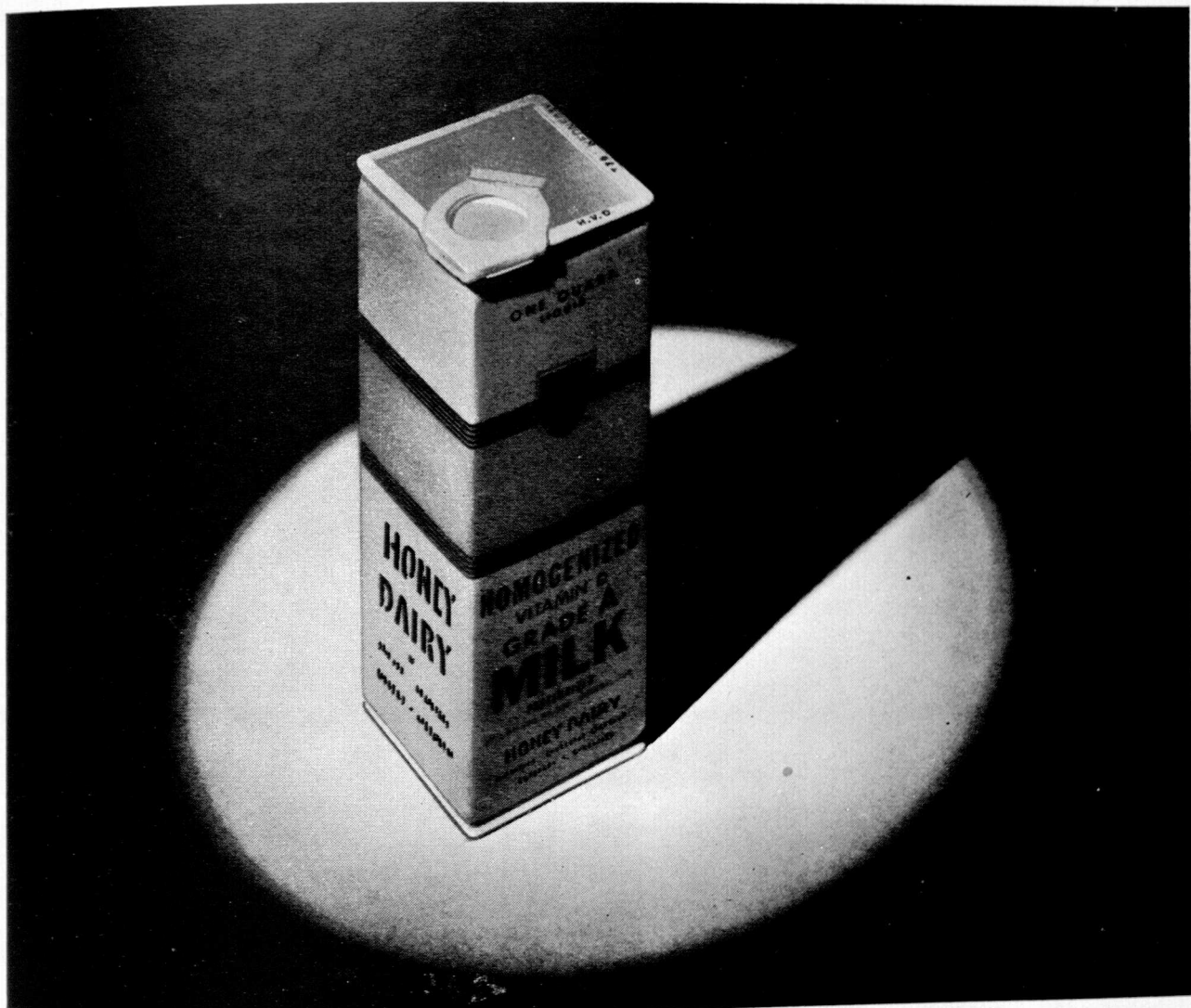

## Why we know this wax carton will stand up

Cartons and wrapping papers coated with paraffin wax have been used in food packaging for many years. They must be able to withstand rough treatment. Their ability to stand up depends largely on the strength and sealing qualities of the coating agent. Yet until a few months ago, there was no accurate way to measure these qualities in paraffin wax.

Recent experimental work in Standard Oil's laboratories has resulted in a new electrically controlled quantitative test. Expressed as Indiana Coating Index, this test

gives, for the first time, an accurate yardstick of wax qualities which may be correlated with performance in service. It makes possible the production of *uniformly* high quality coating agents.

The Indiana Coating Index is only one of many scientific tests developed in Standard Oil laboratories. Standard pioneered in quality-testing, as it did in developing many petroleum products that have contributed to better living. There is no ceiling on what can be accomplished by Standard Oil researchers, present and future.

# Standard Oil Company

(INDIANA)



L  
A  
N  
S  
I  
N  
G

**Beginning Its  
36th Year  
of Successful  
Stamping  
Service**

S  
T  
A  
M  
P  
I  
N  
G  
C  
O

*Serving  
Manufacturers of*  
AUTOMOBILES  
AGRICULTURAL  
EQUIPMENT  
INDUSTRIAL  
EQUIPMENT  
DOMESTIC  
EQUIPMENT  
LAWNMOWERS  
1159 Pennsylvania  
Avenue  
Lansing, Michigan

## CAMPUS NEWS

By Robert Kitchen

### ELECTRICAL ENGINEERING DEPT.

There has been several changes in the staff of the Electrical Engineering Department since the end of Spring term.

Among those leaving are, Assistant Professor Robert F. Nelson who is now working at Oldsmobile's Engineering Department in Lansing. Instructor Roy J. Smollett has left to venture into the business world. Instructor Harold O. Story has taken a position with the U.S. Government in Washington. Instructor Byron Maine went to work for General Motors; however, he has recently been recalled to active duty by the Navy.

Some of the new staff members are Hugo Myers, graduate assistant, B. S. Oklahoma A. and M., M. S. Michigan State; Aldo A. Cacavelos, graduate assistant, B. S. University of Argentina, M. S. Michigan State, Kenneth V. Nichols, instructor, B. S. and M. S. Oklahoma A. and M. Lenore M. Koessel is the new department secretary. Miss Koessel attended MSC for two years.

### CIVIL ENGINEERING DEPT.

The Civil Engineering Department is planning to develop a new emphasis on hydraulics. To aid and guide this development the department has employed Dr. W. Douglas Baines as an assistant professor. Dr. Baines is a Canadian, born in Edmonton and educated there. He received his B. S. from the University of Alberta. At the State University of Iowa, where he received his M.S. and Ph.D., he worked for the Iowa Institute of Hydraulic Research, specializing in Fluid Mechanics. His most recent paper was presented at the national meeting of the ASCE held in Chicago last month. It dealt with the "Development of the Improvement of the Boundry Layer on Smooth and Rough Surfaces".

New research projects in the department are; the cleaning of dairy pipes by water circulation; the study of sanitary facilities in football stadia; the study of the use of calcium chloride in making concrete; and the study of soil pressures in extreme conditions.

# Product

.. FOR BETTER LIVING

**ALCOA**  
FIRST IN  
**ALUMINUM**

The light metal  
that lasts

# Story

BEHIND THE PRODUCT



**A BETTER KIND OF SCREENING** made of Alcoa Alclad Aluminum. Each wire is a strong alloy core combined with a highly corrosion-resistant outer layer. Result: a lasting screening, that will not weather-stain sills or siding. Cost: no higher than you're used to paying for good screening. Worth asking for, to install in your present frames, or in new aluminum-framed combination screen and storm windows.

## DISCOVERY WHILE SHAVING.

To a certain Alcoa metallurgist, the past few weeks' research seemed futile indeed as he faced his mirror one morning in the late twenties. This problem was a sticker: Army and Navy planes demanded a new kind of aluminum; just as strong, but far more impervious to salt spray and weather . . . Suddenly, as he squeezed the last bit of shaving cream from the tube, a message flashed. He wrapped the empty tube around his finger. Yes . . . a core of strong aircraft alloy . . . like this. An outer layer of pure,

highly corrosion-resistant aluminum . . . like this!

Hastening to the laboratory, he tried out his new idea. It worked! Tests proved it to be everything he hoped it would be. Then he collared the boss roller in Alcoa's sheet mill. Quickly, he explained how this new, more useful form of aluminum was to be made. "Can you roll it, Dan?" the metallurgist asked anxiously.

"Sure we can roll it!" grinned the big, capable man in overalls. Soon a sheet ingot of high-strength alloy, sandwiched between two thinner slabs of almost pure

aluminum, was slamming through the shining rolls. It grew wider, thinner at every pass—a sandwich, welded by the tons of pressure into a single unit. Finally, there emerged a new, protected kind of aluminum sheet. We called it "Alclad" Aluminum. And it came to be a mighty factor in America's air power. Most military and civil planes wear this strong shining skin.

We learned to make it into rods and tubing, even to draw it into fine wire. And thus, among many other things, a better kind of screening was born.

# Moral

FOR THINKING PEOPLE

**BECAUSE FREE COMPETITION** demands constant improvement, Alcoa stockholders backed this metallurgist and his fellow researchers, until their perseverance found the answer. Others stood ready, in plants, sales offices and management, to introduce the new Alclad products. After 18 years, this better product is still creating new jobs, and helping America toward better living, in home, farm, and industry. Seems like a good system for all concerned. ALUMINUM COMPANY OF AMERICA, 742 Gulf Building, Pittsburgh 19, Pa.



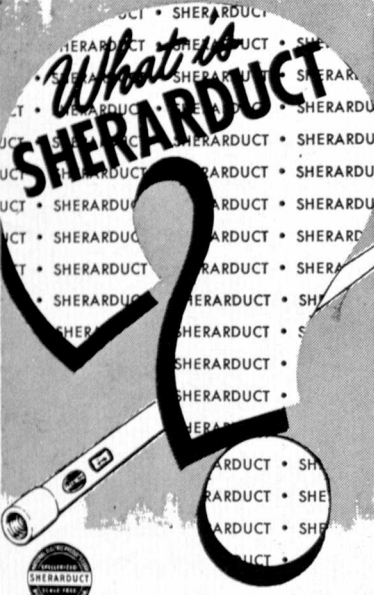

# Alumni News

Jan-Erik Aarburg, M.E., graduated in March of '50 and is now employed by the Norwegian Belt Manufacturing Company of Oslo, Norway. Through contacts made by the Engineering Societies Placement Office, Jan applied for his job with the N.B.M.C. and after a series of interviews was accepted.

At present he is helping his company work out some of the technical problems involved in the operation of U.S. built rubber hose braiders. Many other M.S.C. grads are helping Jan with his problems by sending him some of their information.

Two members of the class of '43 are studying for their Ph.D.'s at the University of London. James Anderson is doing work in heat transfer and John Karpovich is working in E.E. In case some of the '43 grads would like to get in touch with Jim, his present mailing address is Imperial College Hostel, Prince Consort Rd., London SW 7.

Norman Precoda, C.E. '41 is now working with the Atomic Energy Commission at Oak Ridge, Tenn. Norm took graduate work at John Hopkins University in Baltimore, majoring in Math and Physics.

Peter Ruppe, recently resigned as general manager of the Hapman Conveyor Division, Hapman-Dutton Company, so as to devote full time to the operation of his new company, PRAB. He formed this company in conjunction with Alan Bodycombe, graduate of Yale University, and also a former member of the Hapman-Dutton Company. The offices of PRAB INDUSTRIES are located at 20233 Mack, Detroit 30, Michigan.

Pipe, itself, does not have all the properties required of a true electrical conduit. But National Electric processes a special steel pipe into a real quality conduit—Sherar duct.

## Here's how:

- 1 Special high-grade steel is Spellerized—a kneading process that produces fine, even-textured steel.
- 2 The Spellerized steel is rolled into pipe, put through the Scale-Free process and pickled.
- 3 This specially treated pipe is Sherardized—an exclusive process of galvanizing that applies zinc to metal under heat. This affords permanent protection against rust.
- 4 A smooth "Sera-Solution" enamel is baked into the pores to give acid-resistant surfaces.

Then—and only then—do you have Sherar duct, a true conduit . . . long lasting, easily fished, rust proof, easily bent, strong, easy to handle.

Sherar duct is only one of the many outstanding products made by National Electric—a reliable source of supply for your future electrical needs.

EVERYTHING IN WIRING POINTS TO



**National Electric**  
PRODUCTS CORPORATION  
PITTSBURGH, PA.

DON'T MISS THE

# JANUARY

R. E. OLDS MEMORIAL ISSUE

ALSO

"FIND OUT WHERE  
SLIPSTICK MAGIC BEGAN"

# SIDE TRACKED . . . .

If a girl expects to get a husband, she should exhibit one of two things — a generous nature, or else how generous nature was with her.

— Rochester Indicator

REFORMER: You don't expect a glass of that vile stuff to quench your thirst do you young man?

YOUNG MAN: No, sir, that's why I'm going to drink the whole bottle of it.

— Rose Technic

A colored preacher was hearing a confession. In the middle he stopped the young sinner, saying, "Young man, you ain't confessin', you is braggin'."

— Iowa Engineer

A sorority girl wrote home: ".... and I am gaining on this awful food they serve, too. I weigh 120 stripped, but I don't know whether those scales down in front of the drug-store are right or not."

— Purdue Engineer

A comely co-ed met her aunt downtown Saturday night and was given the aunt's pay check to take home. On the way home she was held up.

"Help! Help! I've been robbed!" she cried.

"Someone has taken my aunt's pay!"

A policeman quieted her. "Cut out the pig Latin and tell me what happened," he said.

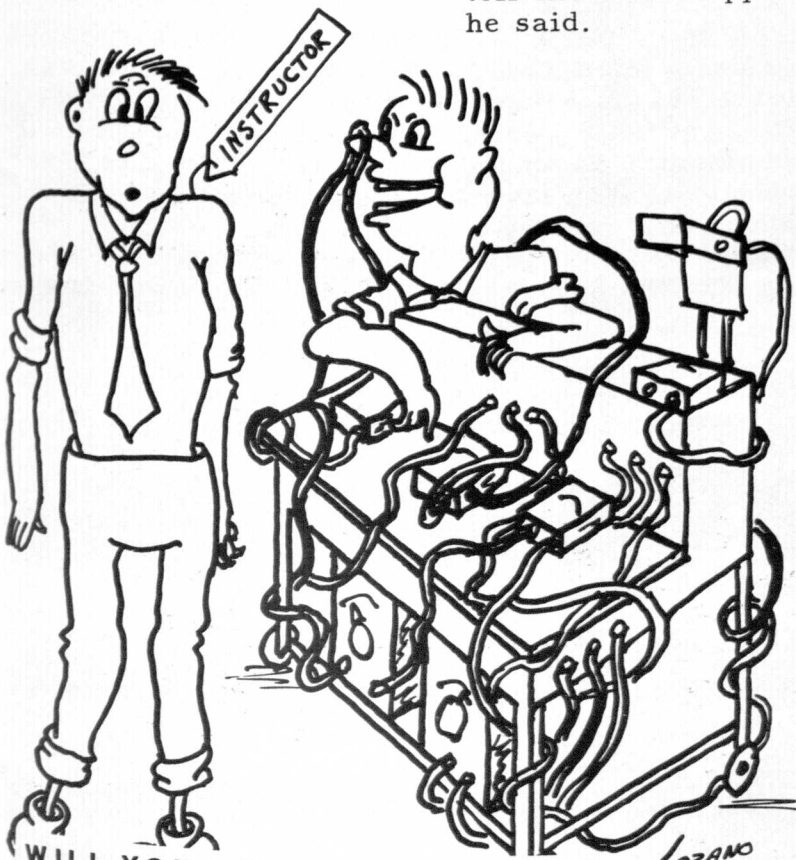

WILL YOU CHECK THIS CIRCUIT TO SEE IF IT'S OK, MR. GRAY

You've probably heard about the Scotchman who was nearly beaten to death because he thought the sign said "Laddies."

KID BROTHER: "Give me a nickel or I'll tell dad that you held hands with my sister."

E.E.: "Here you are."

K.B.: "Give me a quarter or I'll tell him you kissed her."

E.E.: "Here, pest."

K.B.: "Now give me five dollars!"

— Montana Engineer

Just the other day Joe told me about an old parlor game called "Pony Express." It's just like "Post Office" only with more horsing around.

— Duk Engineer

"Are you positive that the defendant was drunk?" asked the judge.

"No doubt," growled the officer.

"Why are you so certain?"

"Well," replied the officer, "I saw him put a penny in the patrol box on Third Street, and look up at the clock on the Methodist church and shout: 'Gawd, I've lost fourteen pounds!'"

— Penn State Engineer

A shoulder strap is a piece of ribbon designed to keep attraction from becoming sensation.

— Purdue Engineer



# SIDE TRACKED . . . .

FIRST Cow: "Where are the rest of the girls?"

SECOND Same: "They are over in the other pasture having a bull session."

— Iowa Engineer

Drunk in phone booth: "Number, Hell! I want my peanuts."

Confidentially, we don't believe all of these wild tales about beer busts.

— Purdue Engineer

PROF.: You can use a 45 volt battery for your lab. experiment.

E.E. Senior: What kind of a battery Mr. Story, A.C. or D.C.?

Webster says that taut means tight. I guess that guys at college are taut a lot after all.

We mourn the passing of the football season because it's the only time of year when you can walk down the street with a blanket under one arm and a girl on the other without causing comment.

"Mr. Smith," said the lady at the church festival, "won't you buy a bouquet for the lady you love?"

"Sorry. I'm a married man."

The train robber was holding up a Pullman car. "Out with your dough or I'll kill all men without money, and kiss all women."

An elderly man said, "You shall not touch these ladies."

An old maid in an upper berth shouted, "You leave him alone, he's robbing this train."

— 'Bama Beam

They say that things are so dry in Arizona that even the trees are going to the dogs.

The naked hills lie wanton to the breeze, The fields are nude, the groves unfrocked, Bare are shivering limbs of shameless trees — No wonder the corn is shocked.

— Penn State Engineer

Old Maid to robber: "Golly, Oh, Golly! Frisk me again."

— Clemson Slipstick

"Lady, you'll have to pay full fare for that boy. He must be over twelve.

"How can he be over twelve, when I've only been married ten years?"

"Listen, lady, I collect fares — not confessions."

— Rose Technic

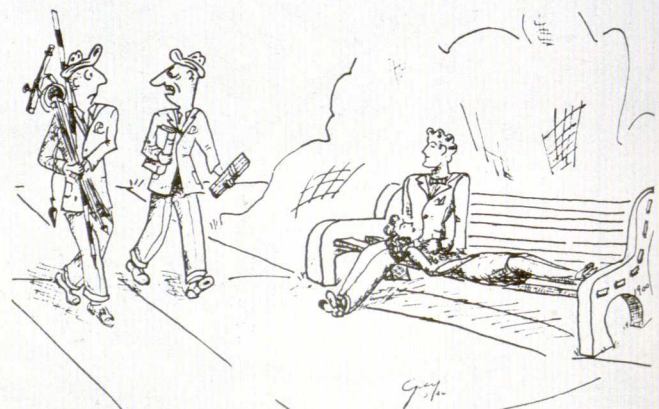
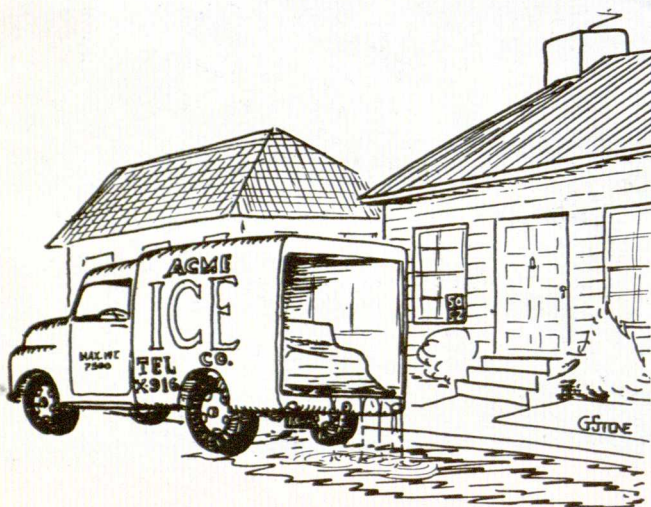

DARN THIS ENGINEERING



## How much magic can a square inch hold ?

**Just a frame of movie film—but think what it can hold. Accurate detail, motion, sound, even lifelike color and much more—miracles that work magic in entertainment, and in business and industry as well.**

Here, in a tiny area far too small to examine easily, photography has captured a moment of life faithful in its finest detail—captured it complete with sound—conversation and music. And all this that's been recorded can be endlessly duplicated so that all the world can thrill to its beauty and drama at the same time and in the language of any land.

Such are the wonders of photography. They are wonders that serve entertainment—can serve science, business, and industry in countless ways as well.

For example, motion pictures can present your product or services graphically and colorfully. They can explain production methods—dramatize safety measures—train salesmen. They can spark interest and understanding in the classroom.

With pictorial animation they can make difficult processes clear. They can make time go fast, go slow, or even backward, to facilitate a study or improve a demonstration. All of this because of the inherent magic in photography.

You can use this magic in your occupation. When you meet problems in production, management, or sales, it will pay you to find out how they can be handled better, faster, and more accurately through photography.

**Eastman Kodak Company, Rochester 4, N. Y.**

ADVANCING BUSINESS AND INDUSTRIAL TECHNIQS

**Functional Photography**

**Kodak**

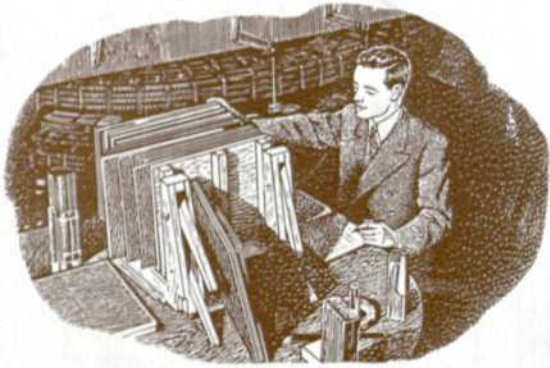

*PHYSICISTS at G.E. find opportunities in the Company's atomic research projects.*



*MATHEMATICIANS work on such G-E developments as the differential analyzer and other computers.*

*ENGINEERS — whether EE, ME, CE or other—have found work to their liking at General Electric. Here an electronics specialist works on television development in the G-E Research Laboratory.*

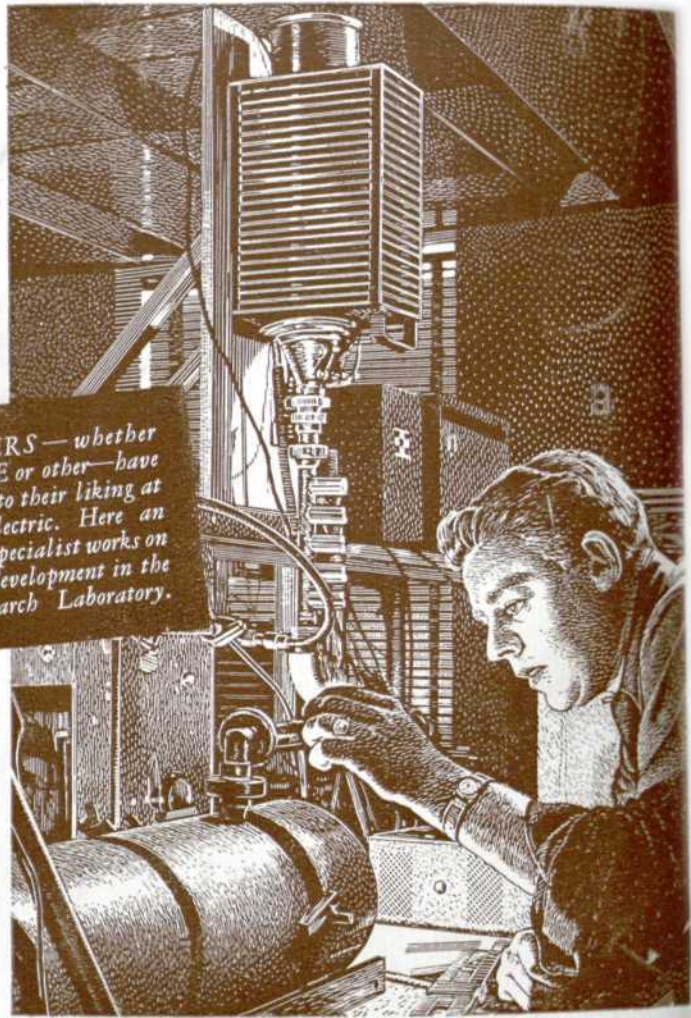

## General Electric's corps of scientific, engineering, and technical specialists has more than doubled since 1941

Products, like streams, rise no higher than their source. At General Electric the source of new and better products is our corps of scientists, engineers, physicists, chemists, and other technicians, recruited from American colleges and given further opportunities for study and training in long-established G-E courses.

In the years since 1941, General Electric has increased this corps of technical graduates from less than five thousand to more than ten thousand.

These men and women have found themselves needed in the Research Laboratory, the Knolls Atomic Power Laboratory, and more than twenty other G-E

laboratories . . . in the engineering and developmental staffs of nine G-E Operating Departments, ranging from the manufacture of heavy industrial equipment to the making of lamps and chemicals . . . in manufacturing and sales . . . in such new undertakings as jet engines, radar, silicones, gas turbines for locomotives and electric power generation.

At General Electric, prime importance is placed on recognizing and developing talent and skill, on providing incentives for creative thinking, on keeping ahead in electrical research, engineering, and manufacturing.

*You can put your confidence in—*

**GENERAL  ELECTRIC**