

COOPERATIVE EXTENSION SERVICE

Departments of
Human Environment and Design
Agricultural Engineering
Urban Planning and Landscape Architecture

MICHIGAN STATE UNIVERSITY

Extension Bulletin E-999

July 1976

SPACE-STRETCHING STORAGE--IDEAS

No.1 DRAWER STORAGE

Dividers in drawers help keep small articles neatly stored.

To make a pattern for drawer dividers, fit a piece of paper in the bottom of the drawer and arrange items on the paper. Mark space needed for each item or group. Remove paper and draw dividing lines allowing $\frac{1}{4}$ inch for the thickness of the divider.

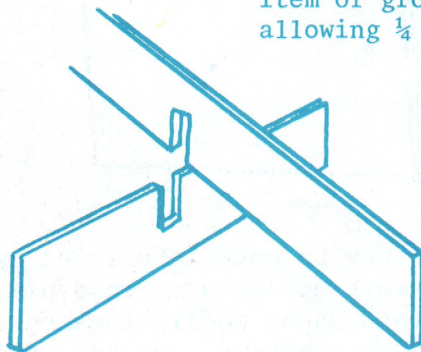

DIVIDERS

Heavy corrugated cardboard dividers may be used for a few weeks to try out your plan before you make permanent dividers. Cut slits (about $\frac{1}{4}$ inch wide) half of the height of the divider. Fit dividers together by matching slits as shown in picture. Allow one inch or more space above the divider for clearance when closing the drawer.

WIDE DRAWERS

Large drawers may need a number of partitions patterned to fit the articles stored. Plan to keep little used equipment in the rear sections.

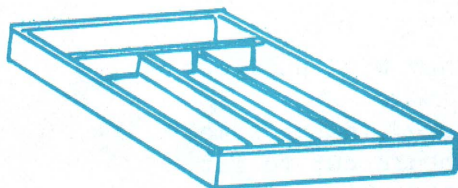
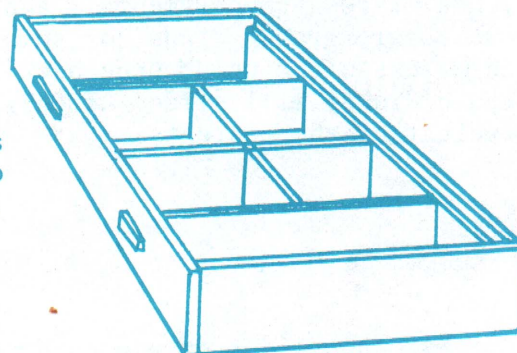

CUTLERY TRAY

Removable trays of plastic or wood can be bought for storage of cutlery and silver. Place tray in drawer so that handles of articles stored are toward the front for easy grasping.

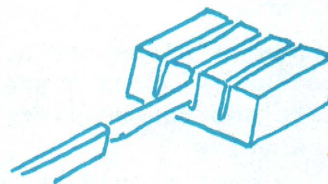

KNIFE SLATS

A wooden block with slots for knives may be glued or nailed to the bottom of a drawer. Allow 4 1/2 to 5 inches for storage of three knives, depending on the thickness of handles. Proper knife storages helps keep cutting edges sharp and also protects fingers.

Deep Drawers have a number of uses if they are located in the right work areas.

SLIDING TRAY

Make a deep drawer more usable for small items by fitting it with a sliding tray. The tray may slide from side to side or front to back but should not cover more than half the top drawer.

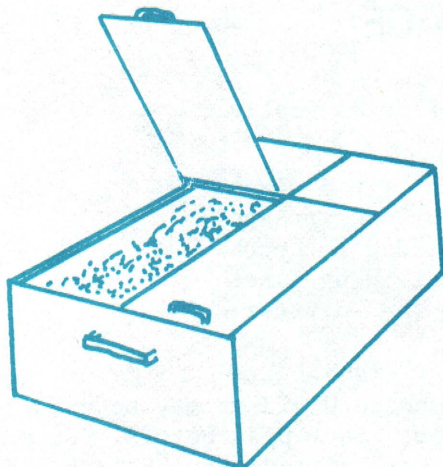

Fit sheet metal containers with hinged lift-up covers into a drawer to serve as canisters for flour and sugar. If drawer is large, use three compartments and store brown sugar, graham flour, or some food which is less often used in the back. Make certain drawer will slide freely with the weight of the contents.

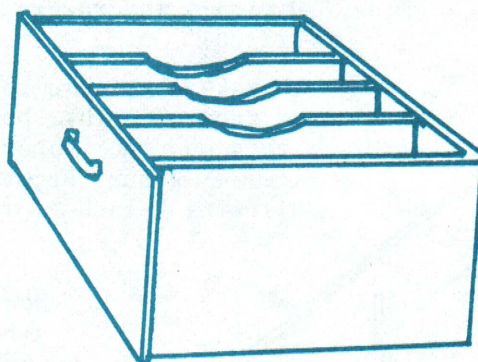
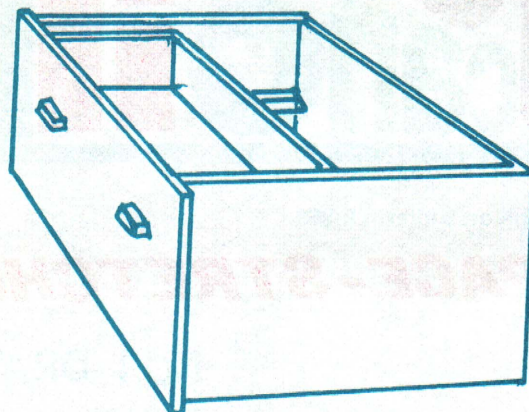

Deep drawers may be made into files by adding removable dividers. Store pie, cake, and bread pans, muffin tins, cake cooling racks, platters, trays, and other flat items.

The partitions may run parallel or perpendicular to the drawer front depending on the width of the drawer and size of equipment to be stored.

*Wax the glides of wooden drawers so that they will pull out easily.

*If several kinds of placemats are to be stored in the same drawer, place each kind on a sheet of cardboard cut to fit. Then the entire set can be lifted out without wrinkling to get to the one below.

*The back of a drawer should be $\frac{3}{4}$ inch higher than the sides to prevent it from pulling all the way out when in use.

No.2 DEEP CABINET STORAGE

You need some deep storage for large, bulky items, but often 24 inch deep base cabinets provide more depth than you need in proportion to the size of articles stored. Consider some of these ideas to make the most of deep storage spaces.

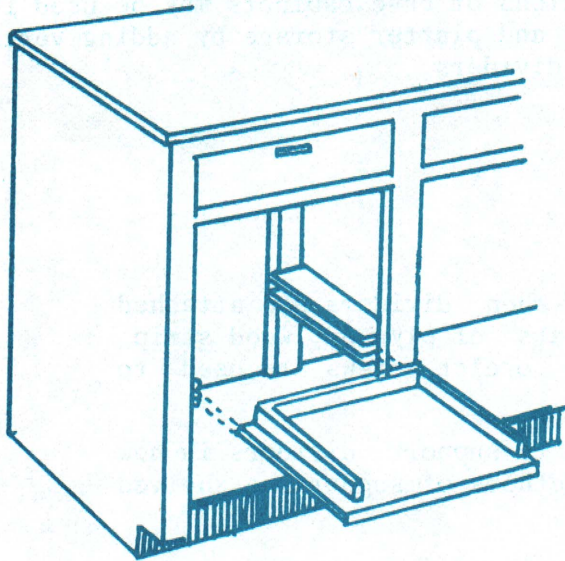

SLIDING SHELVES

Particularly good in the lower areas, the sliding shelf brings all items out where you can see them and conveniently remove them. A guard can keep articles from sliding off the back and sides of the tray.

SLIDING POTHOOKS

Remove the top shelf and space remains for attaching an extension rod with hooks for hanging pots and pans.

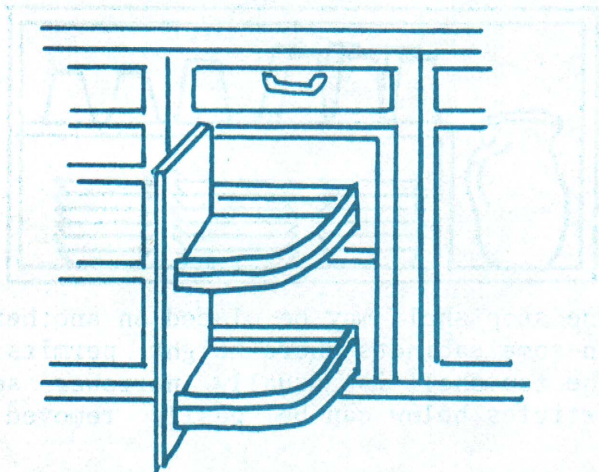
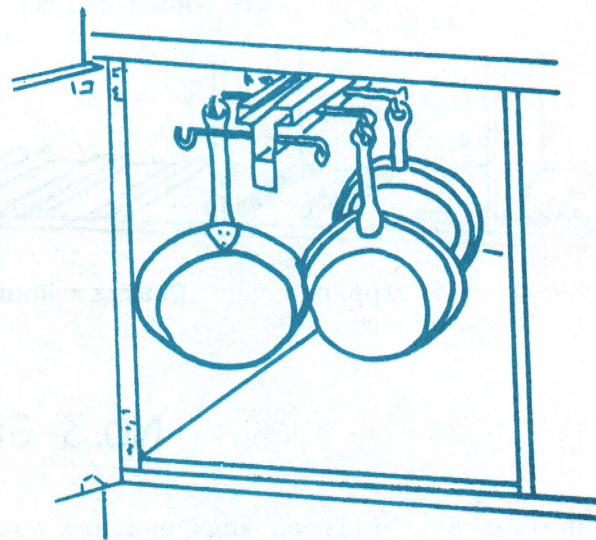

SWING-OUT SHELVES

Shelves can be added to the doors. Be certain they are well supported and have guards to prevent supplies from falling off. Center shelf will not need to be removed if door shelves are carefully spaced.

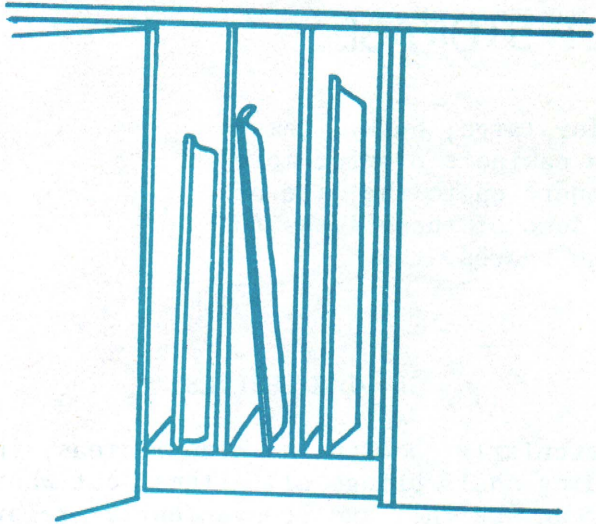

TRAY STORAGE

Sections of base cabinets may be used for tray and platter storage by adding vertical dividers.

To support dividers. When dividers are attached to fixed shelves, cleats of plywood, wood striping, quarter round or eyelet screws are used to hold dividers in place.

Grooving is often used to support dividers in new construction. Some methods of supporting shelves are shown below:

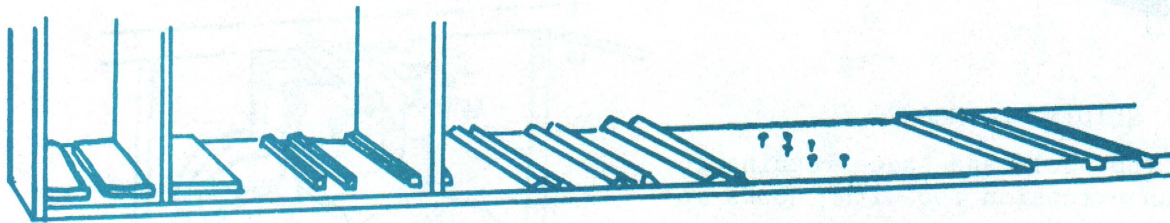

Plywood

Stripping
of wood

Quarter Round

Screw
Eyes

Grooves

No. 3 SHELVES

Step shelves are built on legs and are not attached to the cabinet. They are usually narrow, about half the width of the cabinet or planned according to the size of articles to be stored. If the shelf is made shorter than the length of the cabinet, space can be allowed for storage of a tall pitcher or other tall item in the same area with dishes and glassware.

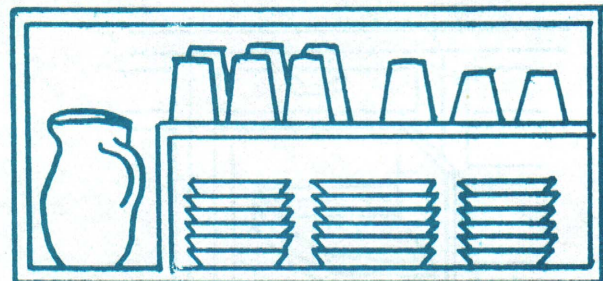

One step shelf may be placed on another in some cabinets where height permits. The top shelf is usually narrower so articles below can be easily removed.

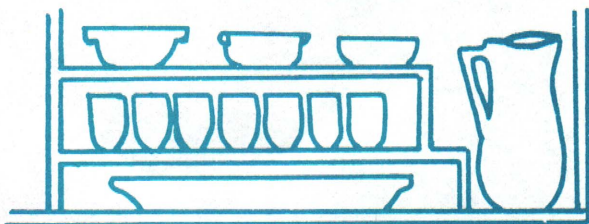

ADD PERMANENT SHELVES

Shelves (usually half the width of existing shelves) may be added by one of the following methods.

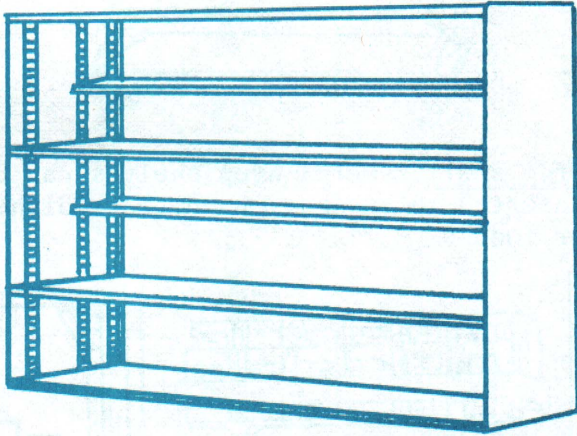

Metal stripping is sturdy, dependable and more expensive than other methods. Stripping makes adjustment of shelves possible and is used when dividing large storage areas.

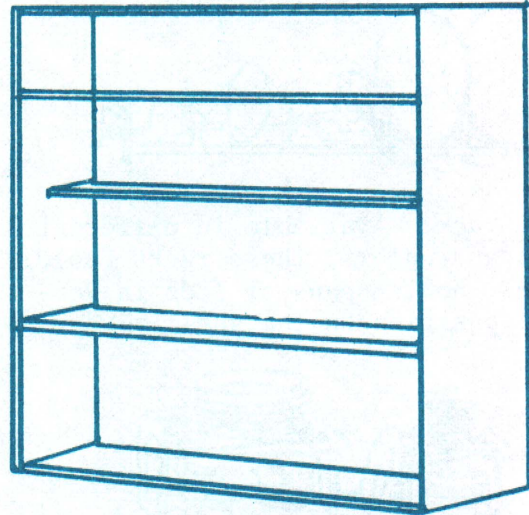

Cleats of wood attached to sides of storage area will support shelves. Shelf positions may be changed by adding cleats. This method requires strong side supports for storage area.

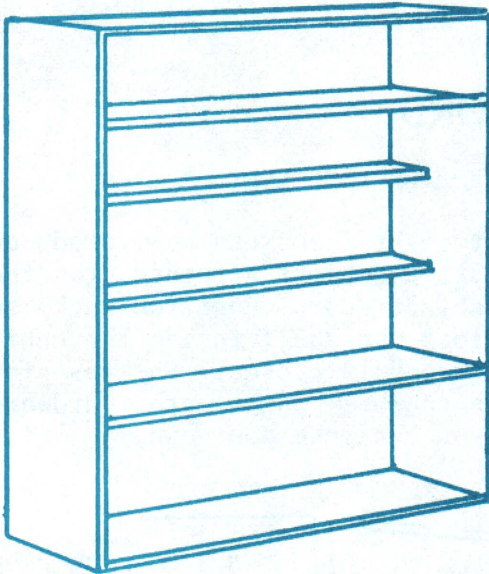

Metal brackets or sections of doweling may be inserted into parallel holes drilled into sides of storage area. A series of holes drilled one

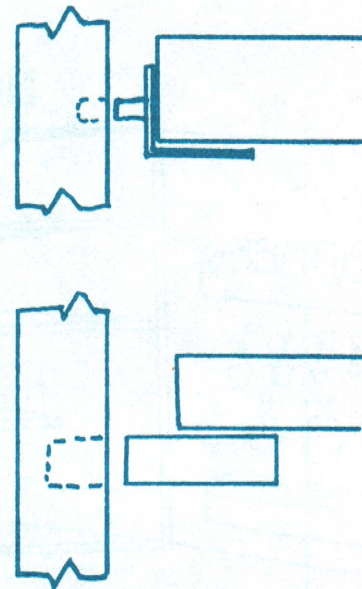

to two inches apart make it possible to change position of shelves. This is an inexpensive means of providing adjustable shelves.

ADD ACCESSORIES YOU CAN BUY

These portable storage conveniences are available in hardware or department stores and mail order houses.

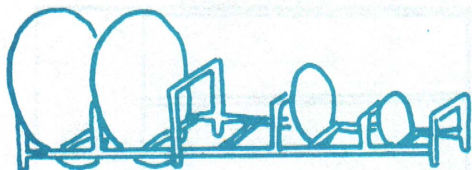
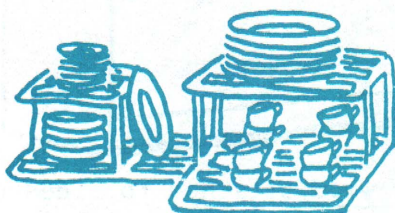
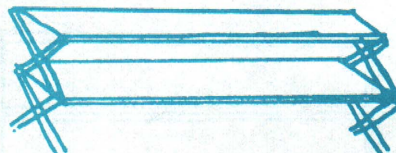

Plate rack. Available in different sizes and colors, these racks hold plates, bowls, pans or lids in vertical position on the shelf.



Rack stores dishes of various types.



Step shelf. Metal step shelves can be inserted in cabinet, used for dishes or foods.

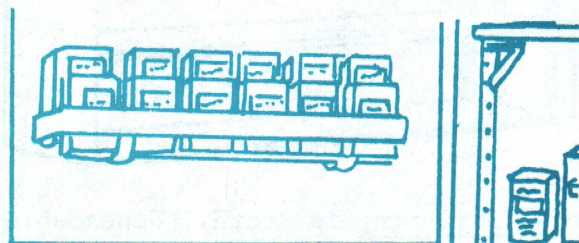

Spice rack. Fasten to door of cabinet in high enough position to clear other items stored on shelf inside. Some racks hold a double row of spices.

No. 4 CABINET DOORS



APPLIANCE INSTRUCTION BOOKLETS

A flat box, partially cut-out, will store instructions booklets for appliances you use in the home.

DOOR SHELVES

Small, lightweight items can be stored on shelves, racks and hooks attached to the inside of cabinet doors. Position racks so they will clear the shelf inside the cabinet when the door is closed. Shelves for this purpose can be bought at hardware stores, or you can make your own.

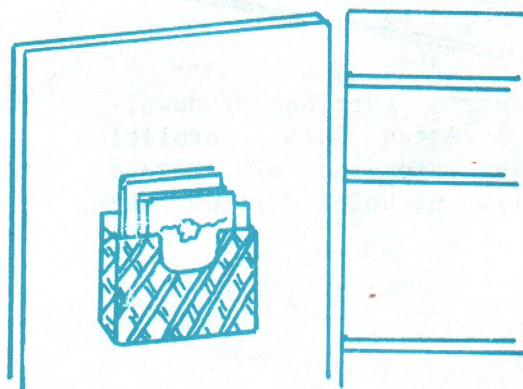

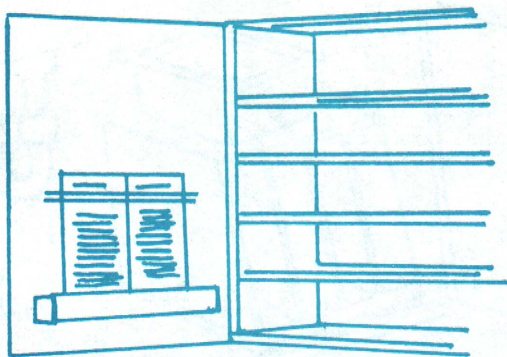

COOKBOOK RACK

A shelf 1 or 2 inches wide can hold a recipe book at eye level for quick reference. Place a strip of elastic near the top to hold the book open.

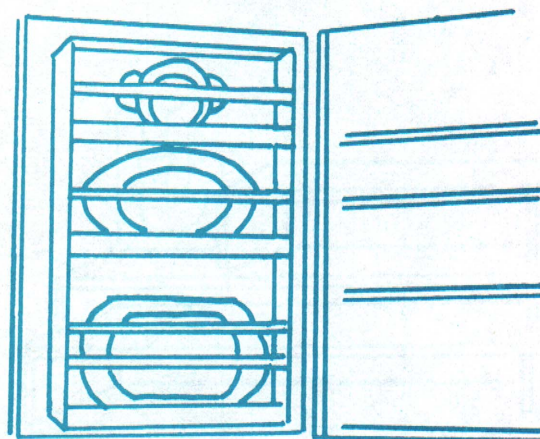

PLATTERS

Platters that are too large to comfortably store on cabinet shelves can be held on shelves inside the door. Allow about 3 inches in depth. Shelves inside the cabinet may have to be cut to allow for this type storage.

NO. 5 UNDER THE SINK

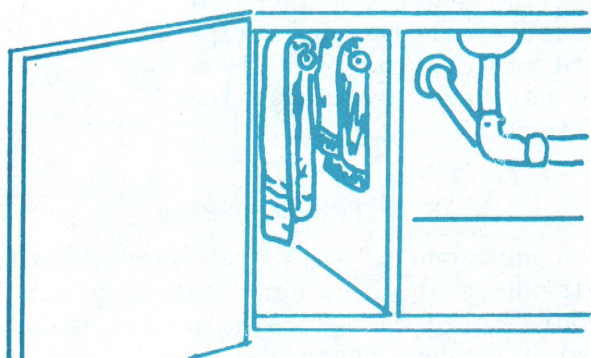

Towel bars. Extension towel bars may be attached to the side of the cabinet, or a stationary rod may be fastened to the inside of the door.

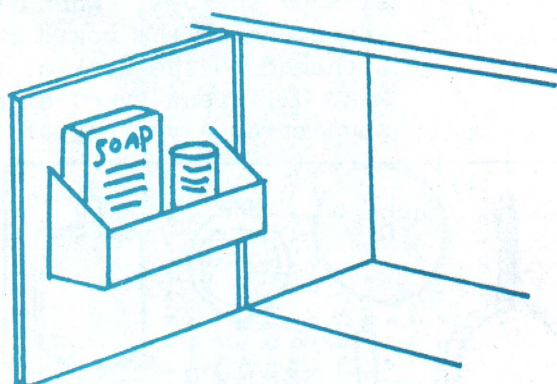

Rack for cleansers. Plastic or metal racks you purchase, or those you make yourself from wood, will store cleansers.

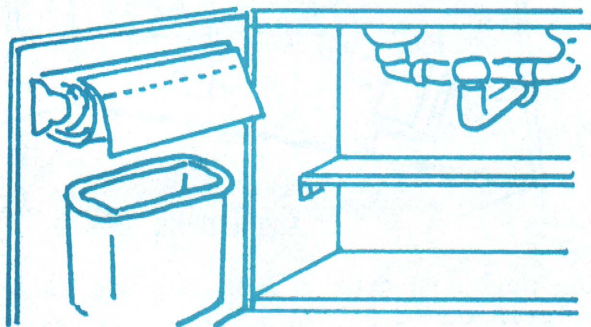

Waste can or basket. Make sure objects will clear the sides of the opening when door swings shut.

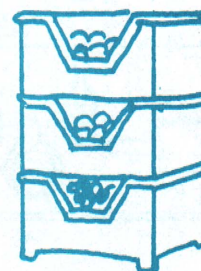

Vegetable bins. Stackable plastic bins for potatoes and onions are now available, or you can make wooden bins (be sure to allow for ventilation).

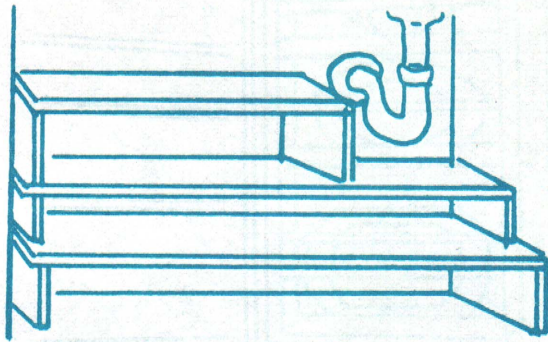

Step shelves. One or more wooden step shelves may be fitted around the pipes to give the storage for cleaners, empty bottles, tool kit, etc.

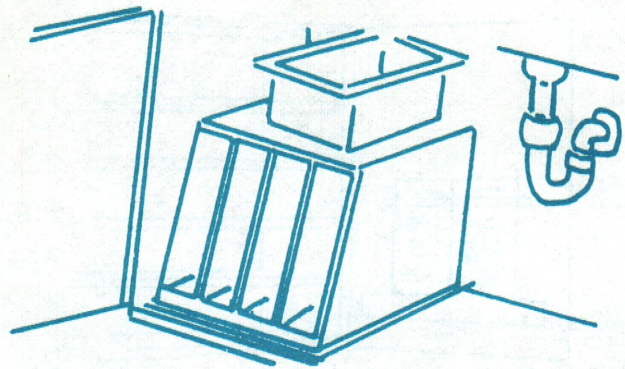

Vertical dividers. Portable vertical dividers can be used for drain racks, wash basins, and flat items.

No.6 HOW TO USE PEGBOARD

Pegboard may be used in a variety of ways for hanging utensils or shelves. When installing, allow about 1/4 inch of space behind the board for pegs to be inserted. Wood strips attached to the back of the pegboard would allow for this. Many different types of hardware or pegs are available for supporting a variety of tools and utensils.

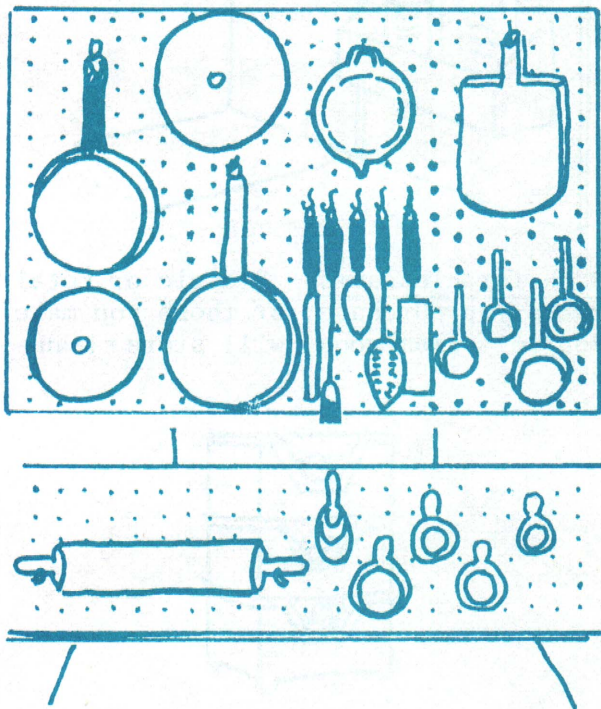

NEAR MIXING CENTER

Mount pegboard on wall between wall and base cabinets and use hooks to hold rolling pin, measuring cups, measuring spoons.

ABOVE COUNTER SPACE

If you have unused wall area over the range or elsewhere in the room, cut a piece of pegboard large enough to hold the utensils you wish to hang there.

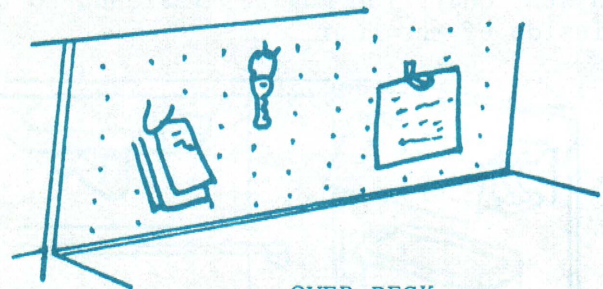

OVER DESK

Hang pegboard over a desk for use as a bulletin board.

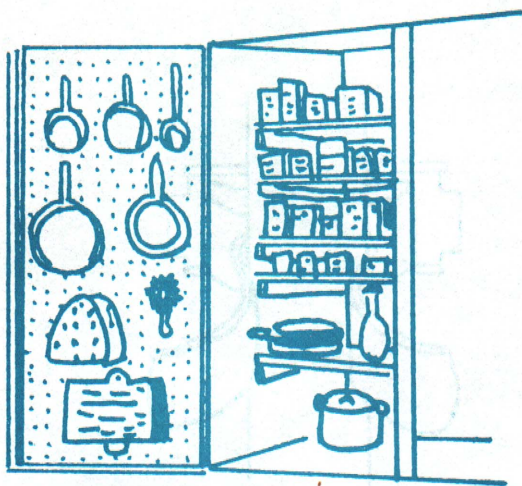

ON CLOSET DOOR

Line the inside of a closet, pantry or cabinet door. Insert the proper hardware for shelf supports and hanging utensils.

A large section of pegboard behind a door is handy for hanging jackets, repair tools, etc.

No. 7 HOW TO HANG EQUIPMENT

TOWEL BARS

Plastic, glass, metal and wooden rods may be used to hang towels and other cloths. Towel rings of plastic, glass and metal are also available. Some of these may be attached with adhesive, others with screws or nails.

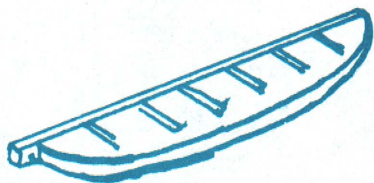
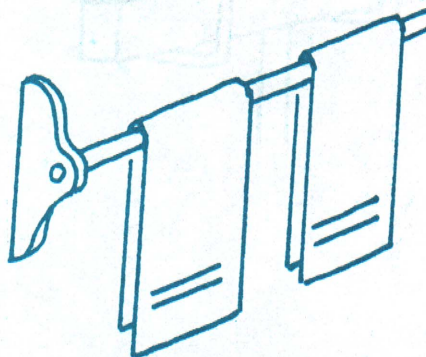

KNIFE RACKS

Wooden knife racks may be made or bought and hung on the wall above the work counter. A device which holds several knives by magnetic attraction is also available for wall mounting.

HOOKS FOR SMALL ARTICLES

Small hooks may be used to hang measuring cups, a dust pan or other light weight equipment. Some hooks made of plastic have adhesive backing for easy attachment to tile, metal, wood or plaster.

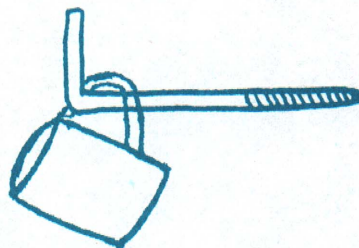

LARGE ARTICLES

Large hooks may be fastened to a door, wall or side of cabinet. Similar hooks are also available for use in pegboard.

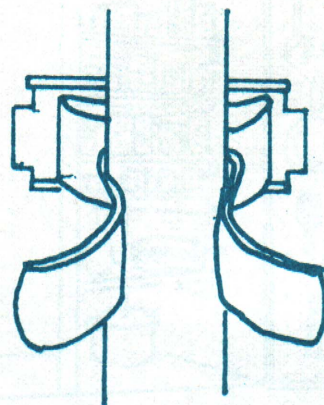
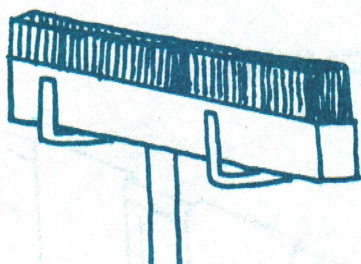

BROOM AND MOP CLAMPS

Clamps screw into the wall, door or side of a broom cabinet. Any handle tools, brushes, mops, brooms may be hung.

Cooperative Extension Service Programs are open to all without regard to race, color, creed, or national origin. Issued in furtherance of cooperative extension work in agriculture and home economics, acts of May 8, and June 30, 1914, in cooperation with the U.S. Department of Agriculture. Gordon E. Guyer, Director, Cooperative Extension Service, Michigan State University, E. Lansing, MI 48824.



Faint, illegible text at the bottom of the page, possibly bleed-through from the reverse side.