

FILE COPY  
DO NOT REMOVE

# HEAT *For Milkhouses and Milking Parlors*

COOPERATIVE EXTENSION SERVICE • MICHIGAN STATE UNIVERSITY

BY TRUMAN C. SURBROOK AND JAMES S. BOYD  
Department of Agricultural Engineering

DURING THE WINTER MONTHS the milkhouse and particularly the milking parlor can be a cold, uncomfortable place to work. A dairy farmer spends many hours in these rooms so they should be made comfortable.

Three major factors need to be considered to make a milking facility comfortable and economical; (1) proper construction; (2) utilization of the heat released from the milk; and (3) selection of an auxiliary heating unit. Careful consideration of these factors will result in maximum comfort at a reasonable cost.

## Construction

The building should be tight (particularly around windows and doors) and insulated. Both masonry and pole-frame construction are acceptable for the milkhouse and milking parlor. While it is more difficult to insulate a concrete masonry building, they are often easier to keep clean.

**Insulation** — For both types of construction, 6 inches of insulation in the ceiling is recommended. In a pole-frame wall, 3 inches of blanket insulation is satisfactory. If the poles are spaced 4 feet apart, a 4-foot wide roll of 3-inch blanket insulation is most convenient to use (Figure 1).

*These recommendations for construction of milkhouses and milking parlors are in agreement with the Fluid Milk Law, Public Act 233, 1965.*

To insulate a masonry wall, a core wall is used. This consists of two layers with a cavity or core between. The outside layer usually consists of lightweight block while the inside layer is usually 4-inch lightweight block or glazed tile. Two inches of expanded polystyrene or urethane insulation is sandwiched between the two layers. (Figure 2)

Heat can also escape by following a path down through the floor and under the side wall. To prevent this heat loss, perimeter insulation should be installed. Perimeter insulation is merely an extension of the wall insulation vertically down into the ground beneath the floor. A 1-inch by 2-foot sheet of expanded polystyrene or urethane works (Figure 3).

Since window glass is a poor insulator, it is recommended to minimize the window area in the milkhouse and milking parlor. It is important to select doors carefully, since moisture can swell or warp wood doors. Insulated metal doors should be used whenever possible.

**Vapor Barrier** — Installation of a vapor barrier in the walls and ceiling is important to prevent moisture from condensing in the insulation. Four mil polyethylene makes a good vapor barrier, and it should be attached to the ceiling joists before the finish ceiling is put up. With pole construction, the vapor barrier should be attached to the inside surface of the wall.

A vapor barrier is not necessary in masonry walls because expanded polystyrene insulation is moisture resistant if the joints have been well sealed with an adhesive made for the insulation.

# ...proper construction essential

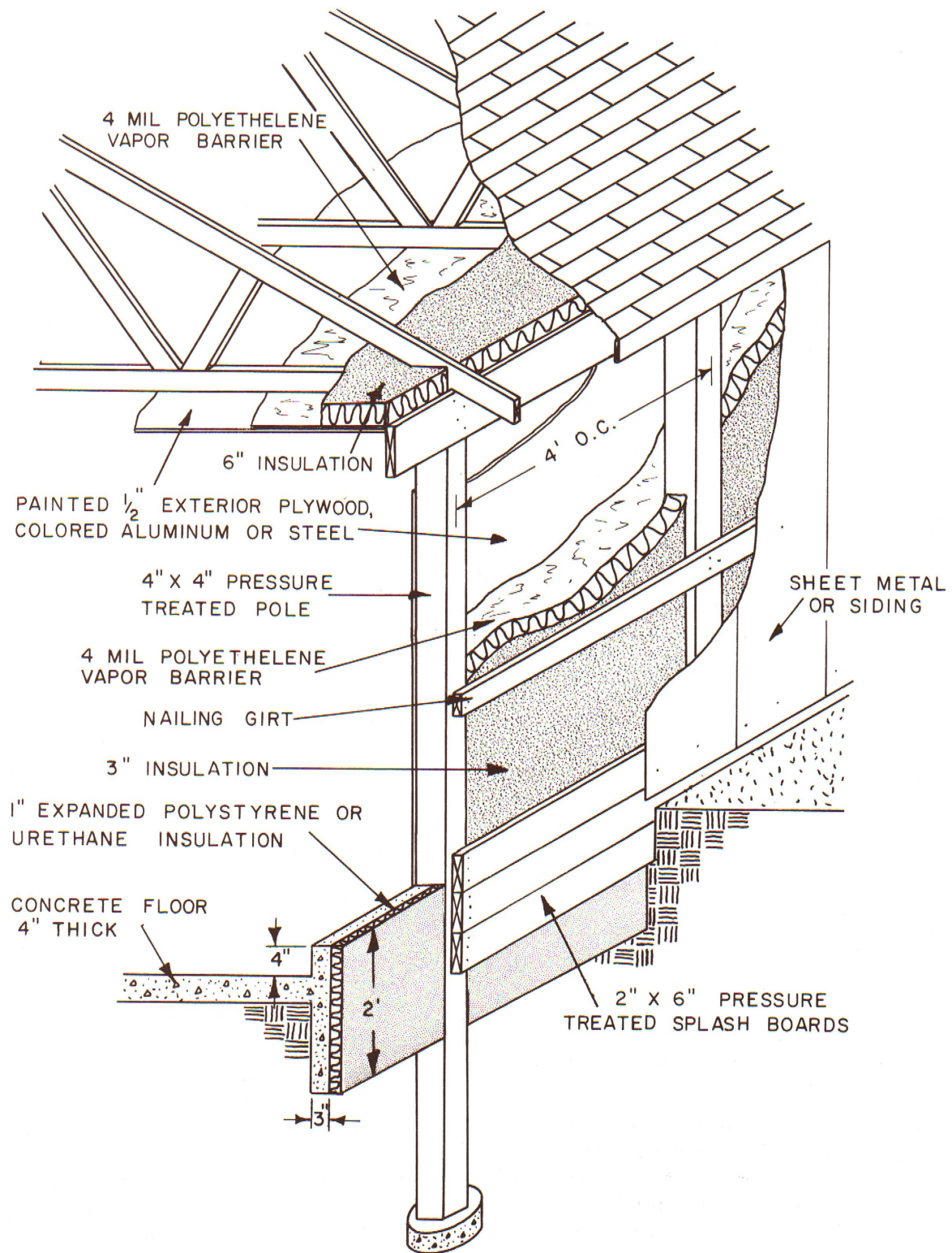

Fig. 1 This pole-frame wall has 4" x 4" pressure treated poles spaced 4 feet apart. A 4 foot wide roll of 3 inch blanket insulation is placed vertically in the spaces between the poles.

**Ventilation** — A manually operated 1,500-cfm (cubic feet per minute) exhaust fan should be mounted in the end of the milking parlor opposite the door to the milkhous. This fan will be sufficient to remove moisture from both the milkhous and the milking parlor. It is important that air flow be from the milkhous to the milking parlor to prevent odors from getting into the milkhous.

To insure effective removal of moisture, the exhaust fan should be controlled by a switch and operated during milking when moisture accumulation is greatest. If this procedure is followed, operation of the exhaust fan between milkings will usually not be necessary.

Moisture accumulation in the attic can be a problem. A louver installed in each gable of the building will allow the moisture which collects in the attic to escape, without condensing on the roof.

**Wall Finish** — The inside surface of a pole-frame wall must be constructed of a material with high resistance to moisture. One-half inch exterior plywood painted with epoxy paint, or colored aluminum or steel with two ounce zinc coating make an easily cleaned surface.

Masonry block walls should be painted with a water-resistant paint (preferably epoxy) after the surface has been made as smooth as possible. This will reduce the amount of paint necessary to produce a tight finish. A true epoxy paint comes in two containers, which must be mixed together before applying to the wall. An inside surface of glazed tile does not require paint.

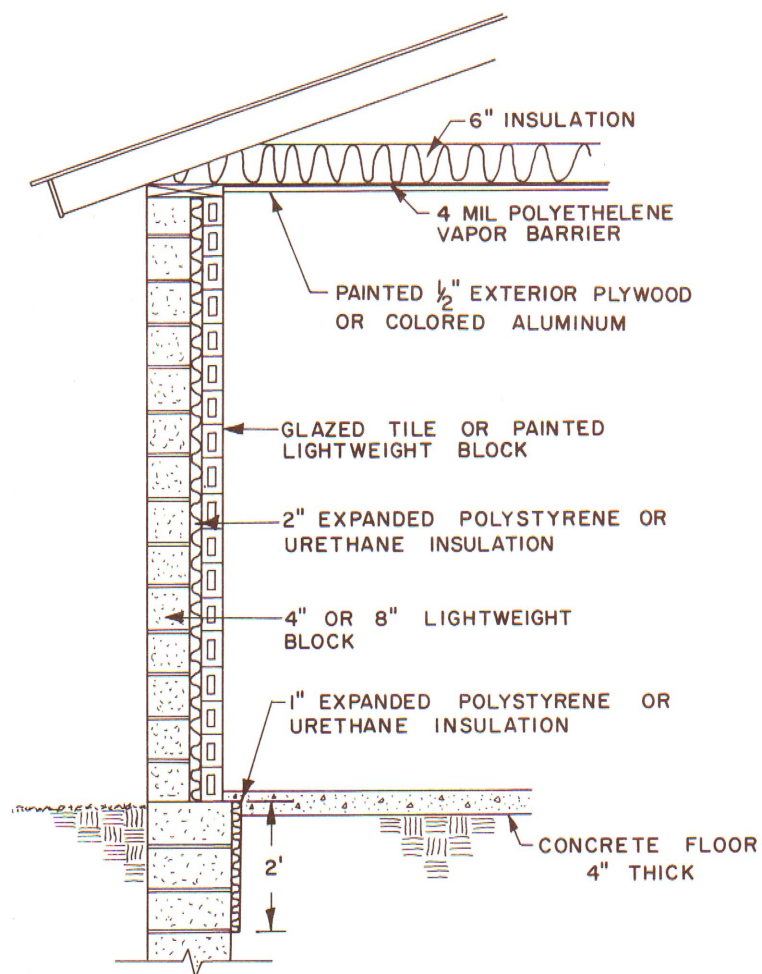
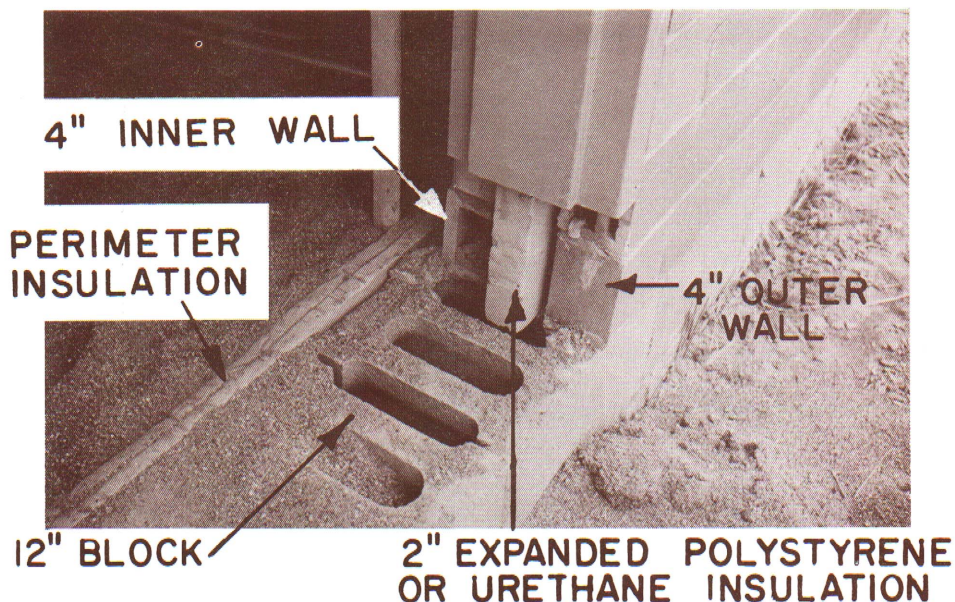

Fig. 2 With masonry construction, rigid insulation is used in a core wall. A special adhesive is used to seal the joints of the sheets of insulation to insure moisture resistance.

Fig. 3 Two inches of expanded polystyrene or urethane insulation can be easily placed in masonry walls.



## Utilization Of Available Heat

When planning a heating system for a milkhouse and milking parlor, consider the heat removed from the milk. This heat, which comes via the compressor, can result in considerable savings, in the cost for heat. The best arrangement for using this heat is to locate the compressor, vacuum pump, water heater and furnace in a utility room. This utility room is kept closed in the winter to form a heat build-up chamber. The heat from the compressor and other machinery accumulates in the utility room and is delivered to the milkhouse and milking parlor through a duct system (Figure 4). This room should not be used as a storage for supplies affected by heat (Figure 5).

The bulk tank compressor should be located in the utility room facing a window that can be opened easily. In cold weather, the window is kept closed so that the compressor draws air from within the utility room. In warm weather, the window is opened so the compressor can draw air from outside the building (Figure 6).

**Note:** The heat removed from the milk can be used to heat the building only when the compressor is cooled by air. This system will not work when the compressor is water cooled.

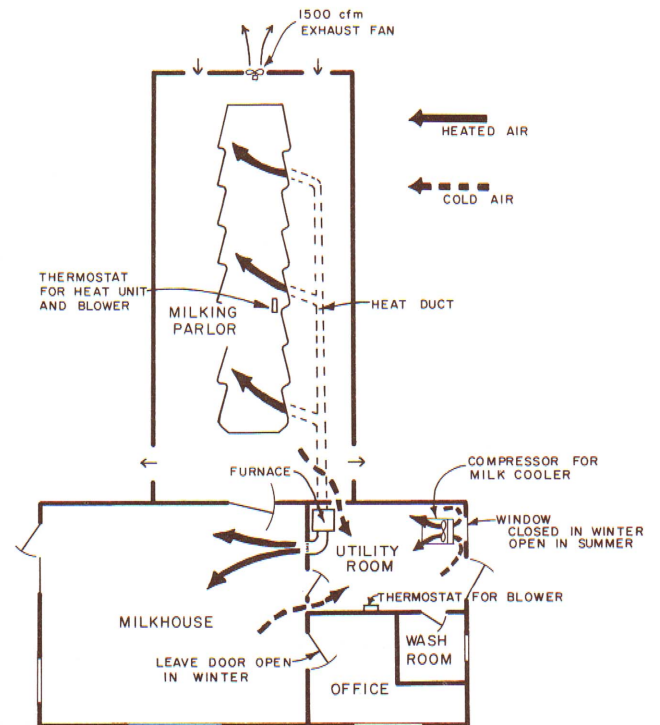

Fig. 5 The heat from the milk cooler and other equipment is delivered to the milkhouse and milking parlor through a duct system. The heat unit in the furnace supplies additional heat when needed.

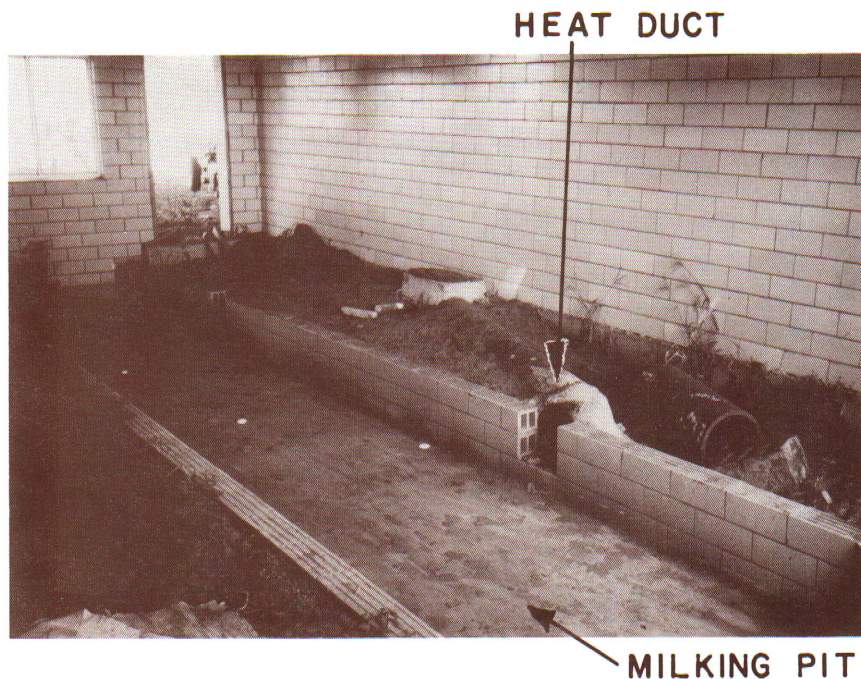

Fig. 4 The heat duct to the milking parlor pit can be constructed of 8 inch tile with cemented joints.

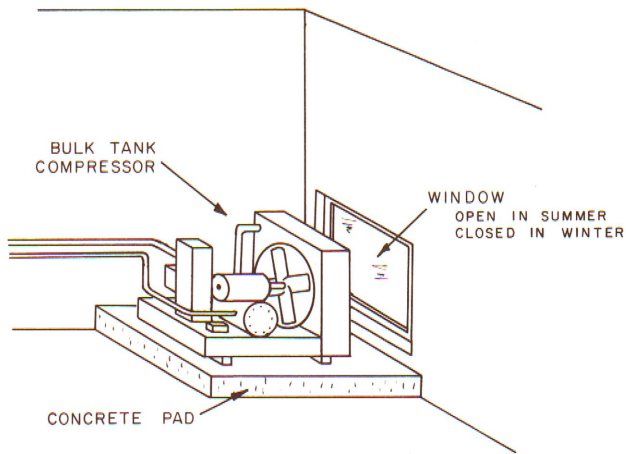

Fig. 6 The bulk tank compressor should be located facing a window or vent. The window is closed in cold weather and open in warm weather.

## Heater Selection

Since the heat released from the milk varies throughout the day, supplemental heat will be necessary to maintain the building at the desired temperature. The best arrangement is to have a furnace equipped with a blower located in the utility room with the other machinery. The blower in the furnace then forces heated air from the milk cooling system into the milking parlor. When the temperature of the air in the utility room drops, the heating unit in the furnace comes on to make up this difference in temperature. The size of furnace for the building can be determined in the following way:

Milking Parlor Size	Furnace Size	
	Kilowatts	Btu/hour
3 and 4 stalls	15	50,000
5 to 8 stalls	20	70,000

## AIR RETURN

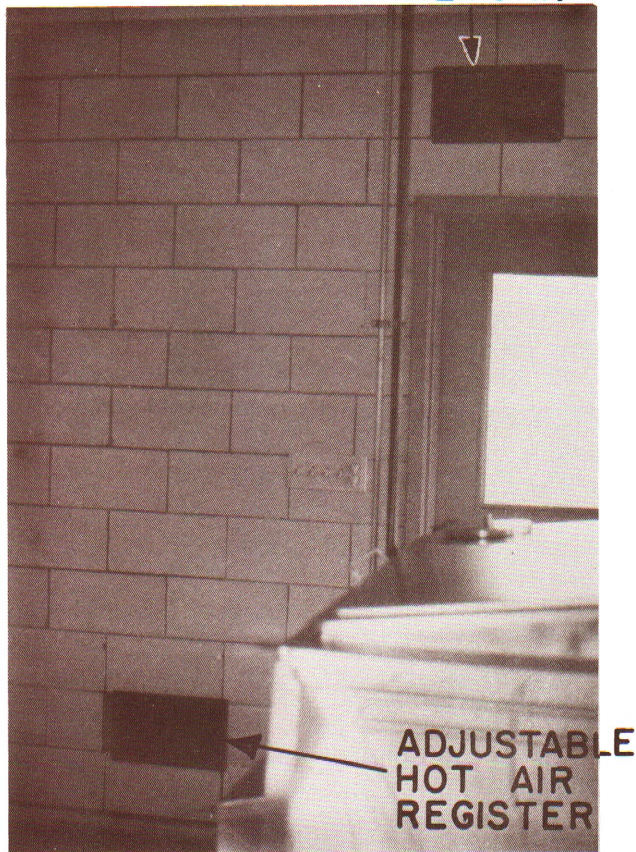

Fig. 7 The adjustable hot air register in the milking parlor is located at floor level with the air return near the ceiling.

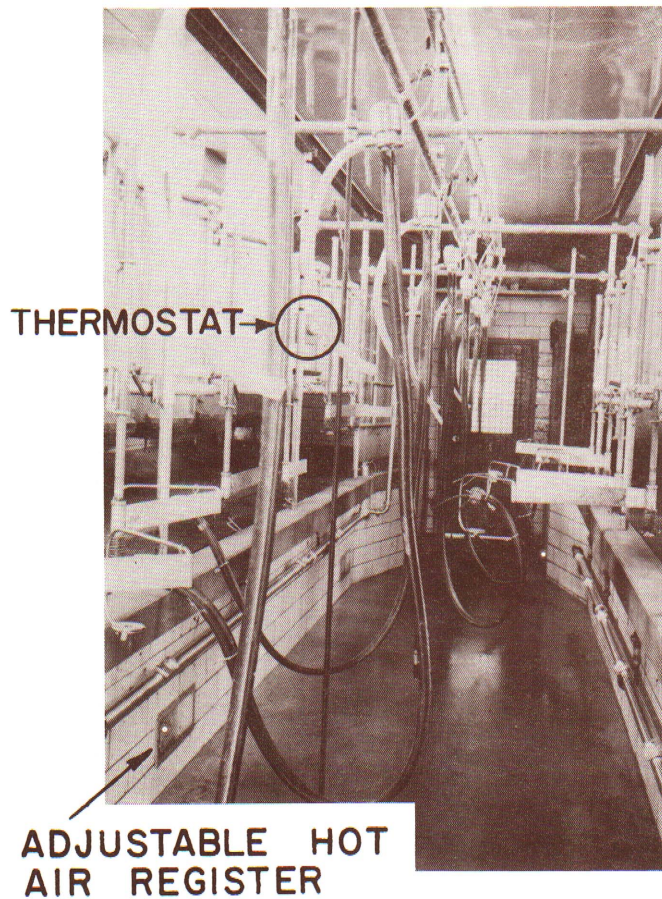
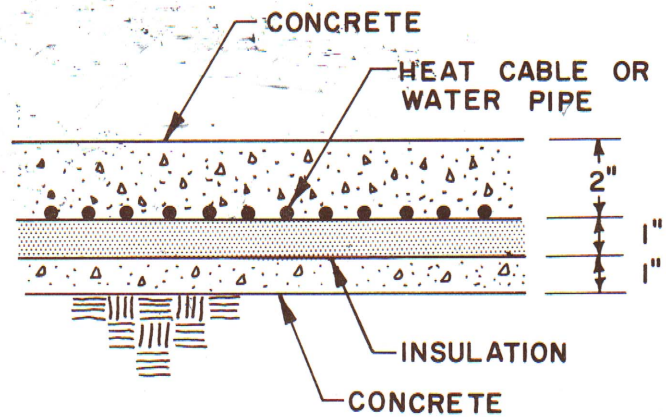

Fig. 8 The hot air registers in the pit must be adjustable to insure an even distribution of heat. Also, the thermostat must be located in easy reach of the operator.

Fig. 9 Heat cable or hot water pipe in cow ramps and walkways will keep them free of ice and snow.



An air return to the utility room is necessary to replenish the air removed by the blower. An air return should be located near the ceiling in the wall between the utility room and the milking parlor. Another air return should be located between the utility room and the milk house. These air returns should be equipped with easily cleaned filters to prevent the circulation of dust and dirt (Figure 7).

Two thermostats are used to control the heating system. One thermostat is located in the utility room and the other in the milking parlor. Costs can be reduced by setting the thermostat in the milking parlor at 40° during periods when the building is not in use. During milking, it can be turned up to make it comfortable for the operator. The thermostat in the milking parlor should be located in easy reach of a man in the pit (Figure 8).

During the milking operation, the compressor on the bulk tank will operate continuously, providing a source of heat when the demand is greatest. A thermostat set at 70° is installed in the utility room and connected to the furnace blower so that the blower will move the heated air out when the temperature in the utility room exceeds 70°. This restricts the heating unit

in the furnace from operating when the milk cooler and other equipment is giving off enough heat to keep the building at the desired temperature. The heating unit in the furnace is used only as an auxiliary heat source to meet the demand when the milk cooling system and other equipment is unable to supply sufficient heat.

It is important to install adjustable hot air registers on each duct opening for easy regulation of the heat going to the milkhouse and milking parlor.

If an office is provided, the most practical method of heating it is to leave the door open between the office and the milkhouse. When the office is in use, the door should be closed and a portable space heater used to raise the temperature to a more comfortable level.

Heating cable or water pipe can be used to good advantage in cow ramps and walkways where ice and snow accumulation can become a problem. Heating cable which will supply 20 to 30 watts per square foot is sufficient for these applications. The heating cable in these areas should be controlled by a switch with a light to indicate when the unit is on (Figure 9).