

FILE COPY
DO NOT REMOVE

RECOMMENDATIONS FOR A SAFE AND ADEQUATE WATER SYSTEM

By Truman C. Surbrook
Department of Agricultural Engineering

COOPERATIVE EXTENSION SERVICE
MICHIGAN STATE UNIVERSITY

in cooperation with
Michigan Department of Public Health
Dairy Division, Michigan Department of Agriculture

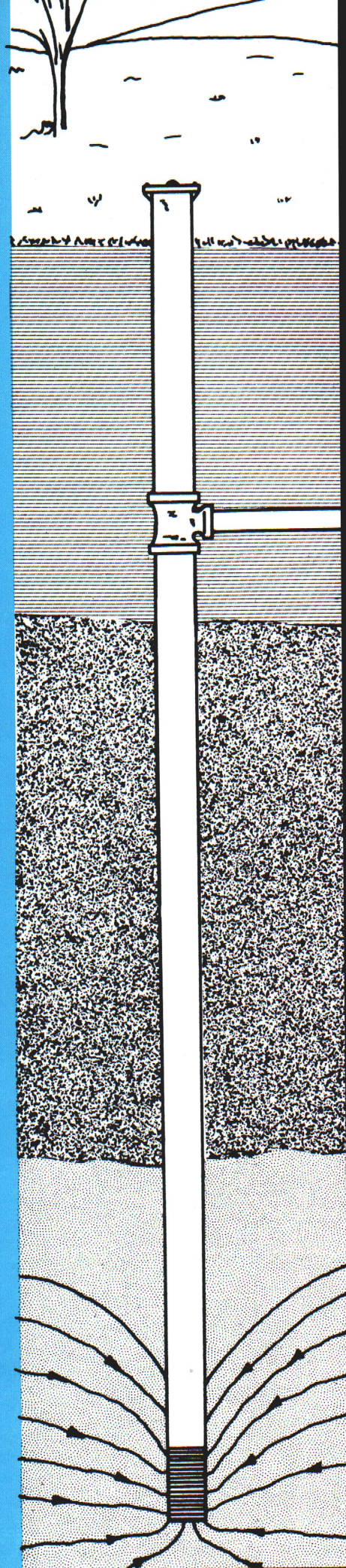

ACKNOWLEDGEMENT

Sincere appreciation is expressed to F. West of the Dairy Division, Michigan Department of Agriculture, and D. Keech of the Michigan Department of Public Health for their technical assistance in the preparation of this bulletin.

RECOMMENDATIONS FOR A SAFE AND ADEQUATE WATER SYSTEM

THESE RECOMMENDATIONS ARE BASED primarily upon the water system regulations set forth by the Michigan Department of Public Health and specify minimum standards for:*

1. well location
2. well construction
3. pump installation
4. distribution system
5. adequate system design

These recommendations are intended for water systems that supply water for domestic use, for motels, restaurants, service stations, and other similar places of public assembly, and for the processing and handling of food products.

These recommendations also apply to the water system that supplies water for cleaning and sanitizing milking utensils on dairy farms selling grade A milk.

WELL LOCATION

1. Locate the well so that it is no closer than 10 feet to any buried sewer or sump pit through which sewage may back up.

**This bulletin is a summary of Regulations 325.1601 through 325.1721 for private, Regulations 325.1451 through 325.1461 for certain water supplies, and grade A dairy farm water system requirements and additional information, and it is not intended to be all-inclusive of the respective regulations and requirements. Copies of the respective regulations and requirements are available from your County or District Health Department.*

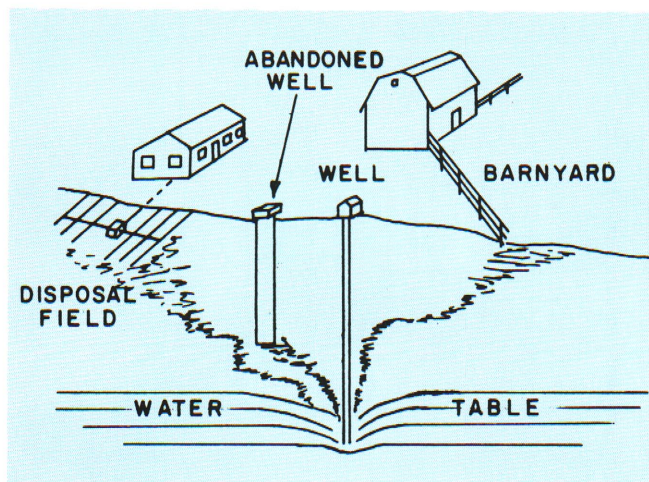

Fig. 1. Contamination could be reaching your water supply if your well is not located a safe distance from contamination sources.

2. Sewers located between 10 to 75 feet of the well must be of service weight cast iron with leaded joints or other approved watertight joints. Septic tanks, disposal fields, dry wells, seepage pits, cesspools, accumulated manure, or any other sewage or liquid waste draining into the soil must be no closer than 75 feet from the well. (For private water systems, the minimum distance is 50 feet instead of 75.)

3. Spray materials, liquid fertilizers, or other chemicals must not be prepared or stored within 150 feet of the well. Many of these materials do not decompose easily, and permanent contamination of the water supply can result.

4. Locate the well at least 3 feet from the overhang of a building, and in an area not subject to flooding. The ground surface immediately adjacent to the well casing must be graded so that surface water is diverted away from the casing.

WELL CONSTRUCTION

1. All well casings must be of at least standard weight steel or iron pipe, watertight throughout its length, with threaded or welded joints.

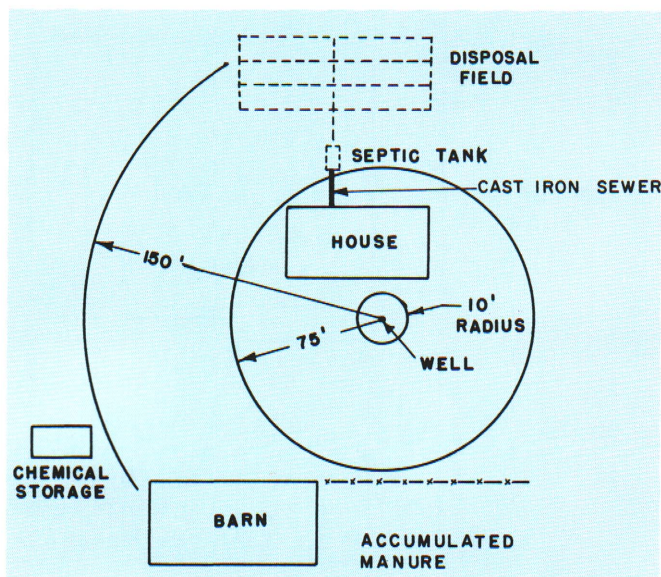

Fig. 2. These are minimum distances to insure a safe water supply for grade A dairy farms, for food processing and handling, and for semi-public use.

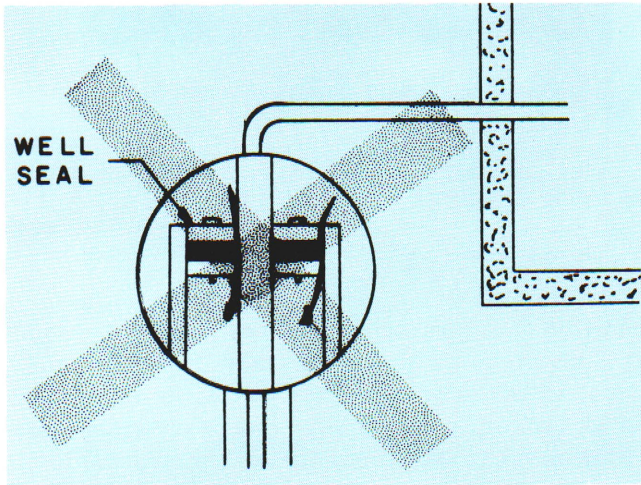

Fig. 3. This is not an approved practice. If a buried well seal develops a leak, contaminants can enter directly into the water supply.

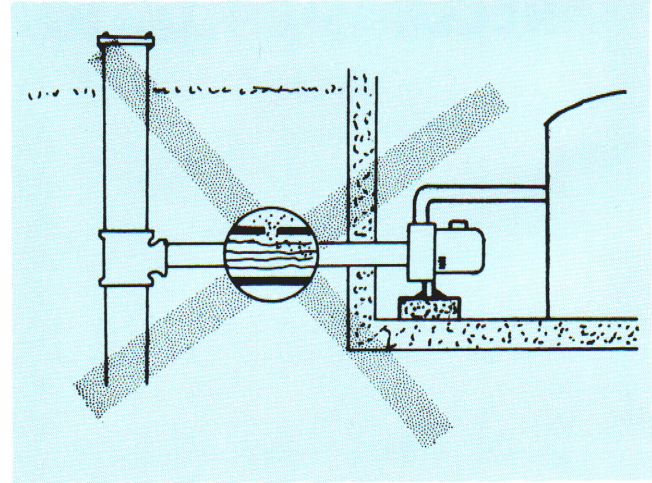

Fig. 4. This is not approved because a leaking, unprotected suction line allows contaminants to enter the water system.

2. A well casing should extend at least 25 feet below the ground surface. If this is not possible, ask your county or district health department to help you design an alternate system for collecting safe water.

3. A well casing must extend 12 inches above ground surface or the floor of an approved below-

grade well room. The well casing must extend 6 inches above the floor of an above-ground well room.

4. The top 10 feet of any casing must not be used as a suction line unless protected by an outer casing.

5. A well, except where an approved pitless adaptor is used, should be protected by a durable water-

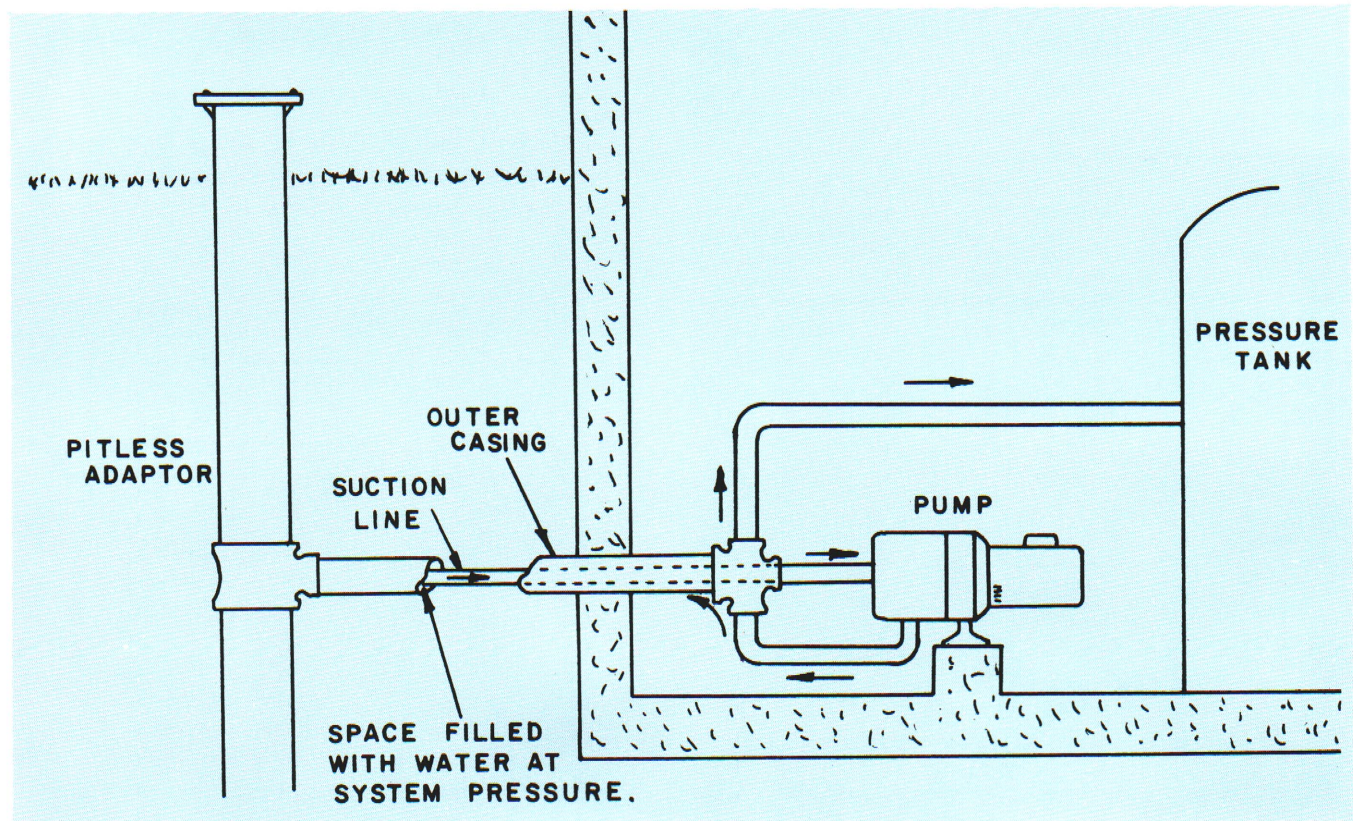

Fig. 5. Because the annular space between the two pipes is kept under system pressure, the suction line is protected. This is a typical shallow well installation. In the case of a deep well jet, the water returning to the jet flows through the space between the two concentric pipes.

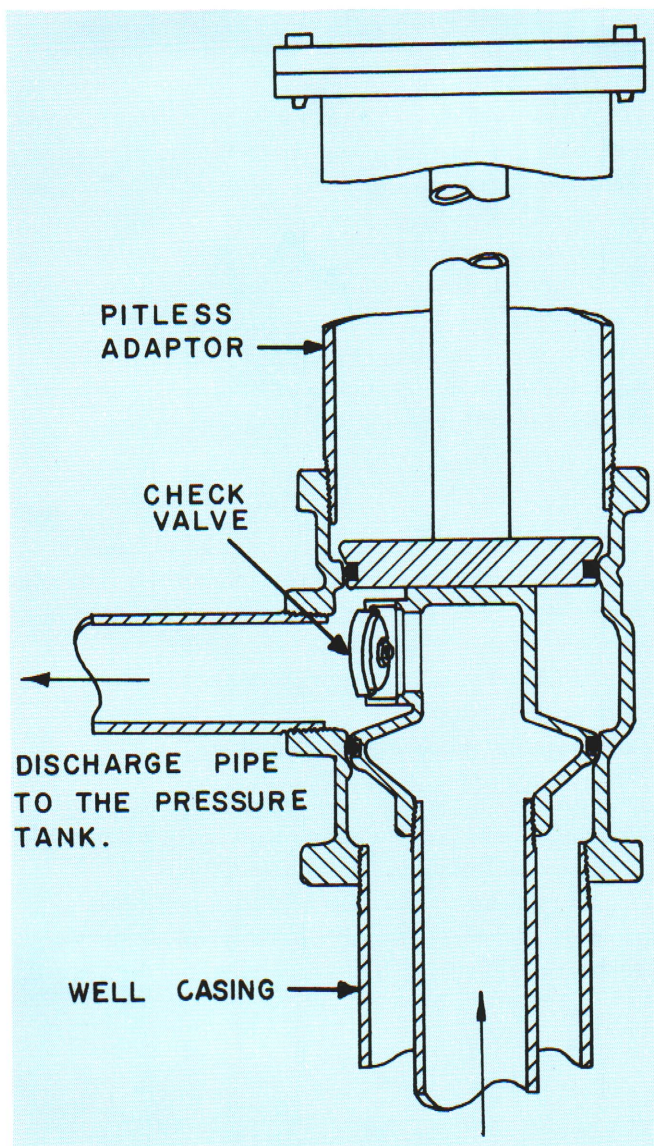

Fig. 6. The check valve prevents the water in the discharge line from flowing back into the well. The check valve must be located inside the well casing.

tight concrete or equivalent slab at least 6 inches thick, extending horizontally at least 2 feet in every direction from the well casing, and sloped to divert water away from the casing. A watertight seal must be provided between the casing and the slab.

Connections to a well casing

All connections to a well casing must be protected by approved metal-to-metal, threaded or welded joints except those connections located at least 12 inches above the ground surface or the floor of an approved well room. Connections made 12 inches or more above grade, however, must be constructed so as to prevent dirt or other foreign material from entering the well.

Water suction and discharge lines

1. All water suction lines must be constructed of copper, galvanized steel, or N.S.F. (National Sanitation Foundation) approved plastic pipe. N.S.F. approved plastic pipe must be a minimum of 126 psi (pounds per square inch) test.

2. Suction lines extending outside the well casing must be fully exposed in an approved basement or well room and at least 12 inches above the floor, or they must be contained within an outer casing with the annular space (area between the suction line and the outer casing) filled with water from the system and maintained at system pressure. (Fig. 5)

3. The water in a discharge line between the well casing and the pressure tank in a submersible, a deep well turbine, or a deep well piston installation must not be allowed to drain back into the well. A check valve must be located within the well to keep the discharge line under pressure at all times.

PUMP INSTALLATION

A room housing pumping equipment or the top of a well casing must be constructed above the established ground surface, or may be located below grade if the containing room is located in or attached to an approved basement. Well pits are not acceptable for new installations. Existing well pits can be approved if they meet certain specifications. For information, contact the appropriate inspector.

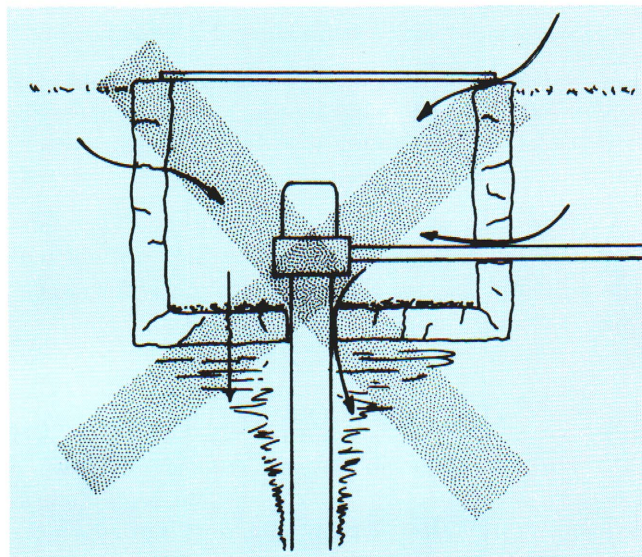

Fig. 7. This is not approved because contaminants can collect in the well pit and seep down the outside of the well casing and into the water supply. Well pits of this nature are also often subject to flooding.

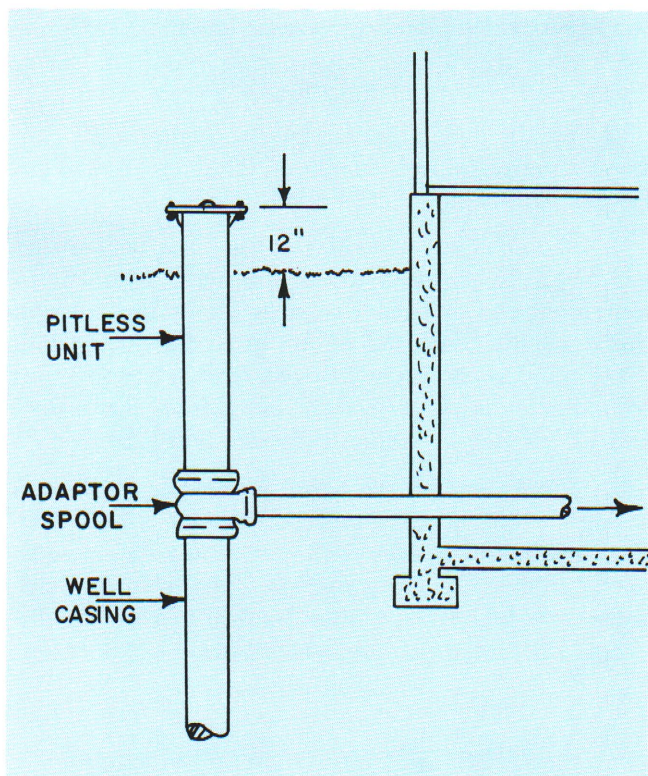

Fig. 8. A pitless adaptor must be watertight. All connections must be threaded or welded.

1. Pitless adaptor — This is probably one of the easiest types to install and maintain. There are many manufacturers building approved pitless adaptors.

2. Above ground well house — A free construction plan for an insulated well house is available on request from the Plan Service of the Agricultural Engineering Department at Michigan State University.*

3. Buried pressure tank — Buried pressure tanks are used in combination with a pitless adaptor and submersible pump. Only approved buried pressure tanks can be used.

4. Well room attached to the basement — This is the only case where a well terminating below the established ground surface can be approved for a grade A dairy farm.

DISTRIBUTION SYSTEM

1. There must be no physical connection between a water system meeting the appropriate requirements and any other water system that does not meet the requirements.

*"Insulated Pump House," Midwest Plan No. 74001, Agricultural Engineering Department, Michigan State University, East Lansing 48823.

2. When drinking fountains are provided, they must be of the angle jet type, with a nozzle at least 1 inch above the rim of the bowl.

3. Stock watering equipment used on dairy farms must have an adequate air gap between the highest attainable water level and the water inlet.

Stock waterers, drinking cups, and float valves often have submerged inlets. These can cause back siphonage, resulting in contamination of the water in the system.

When there is an adequate air gap between the water surface and the inlet, contaminated water cannot be siphoned into the water system.

ADEQUATE SYSTEM DESIGN

An adequate water system is essential for high farm production, convenience, and cleanliness. If you can answer yes to one or more of the following questions, then your water system is not adequate.

1. When two or more faucets are opened, does the water pressure drop?
2. Does the pump run continuously?
3. Do animals have to wait for water?

If one or more of these problems exist, the trouble could be due to one of the following:

1. Insufficient supply of water. If you have a shallow well, a deep well will probably solve the water shortage problem. If the water yielding capacity of

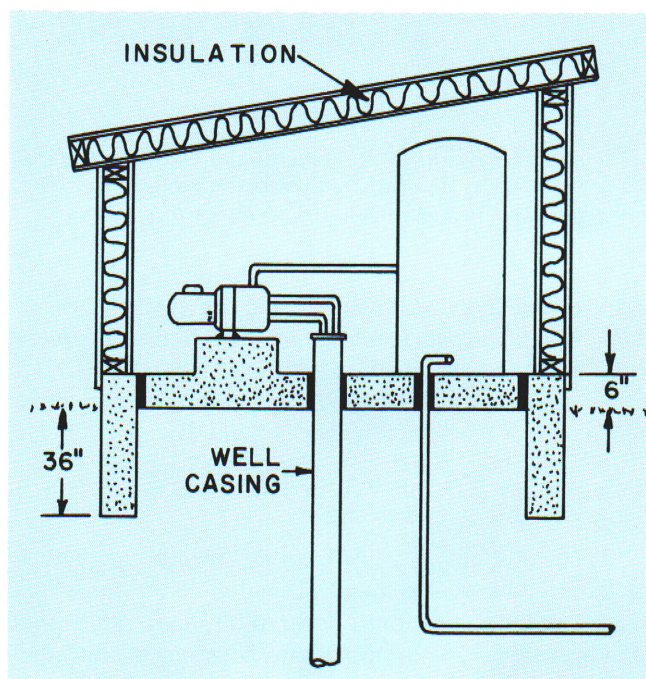

Fig. 9. This is an inexpensive type of installation for a new well or for upgrading a presently unsafe installation.

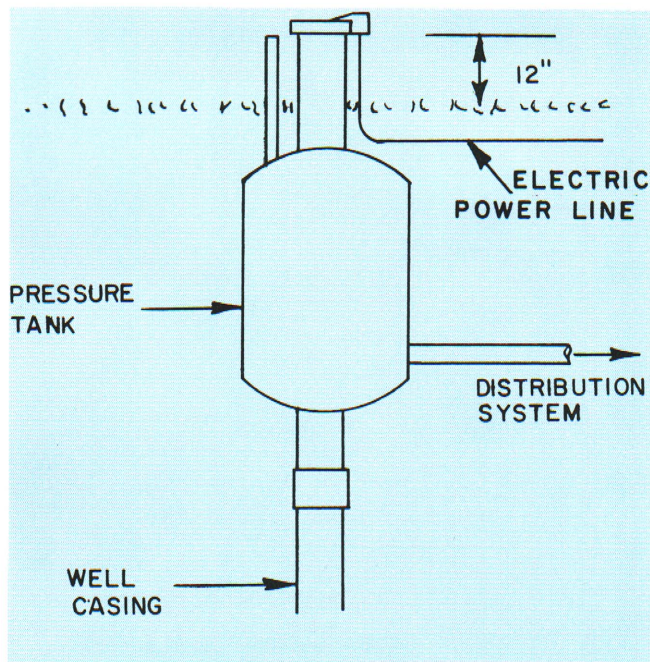

Fig. 10. The buried pressure tank is finding increased use on new installations.

the aquifer (water-bearing stratum) is less than your demand for water, you will have to install a storage tank.

2. The well casing is not large enough, thus limiting the amount of water that can be pumped. If you have a large pump on a small diameter well and the water output is small, then possibly your well diameter is too small. This assumes that your pumping equipment is in good repair and your water supply is adequate.

3. The pump is too small or the pressure setting is not correct. Before replacing your old pump or installing a new one, determine your water need. Select a pump to fit your water need. For help in determining your water need, consult your extension agent.*

4. Distribution pipes are not large enough. Long lengths of pipe and many pipe fittings can greatly reduce the pressure at distant locations from the pump. If you have adequate pressure near the pump, but insufficient pressure at distant locations, your distribution system is most likely at fault. Running a larger new line to a distant location of high water demand will solve the problem. Never install a distribution line of less than 1¼ inch steel pipe or its equivalent.

5. Pump needs repair or replacing (well screen may be plugged). Keeping equipment in good repair will

*"Farm Water System Planning Guide," Information Series #181, file 18.35, Agricultural Engineering Department, Michigan State University, East Lansing 48823.

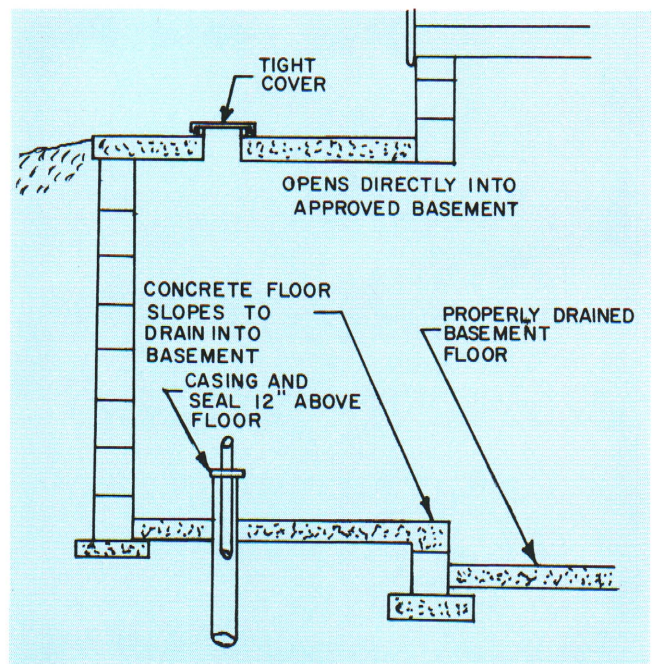

Fig. 11. A well room opening directly into the basement is approved.

insure an adequate water supply at all times. Often times screens, foot valves, jets, etc. become plugged after considerable service.

WHERE TO GET ADDITIONAL HELP

Additional information regarding private or semi-public water systems can be obtained from your county or district health department, or the Michigan Department of Public Health in Lansing 48914.

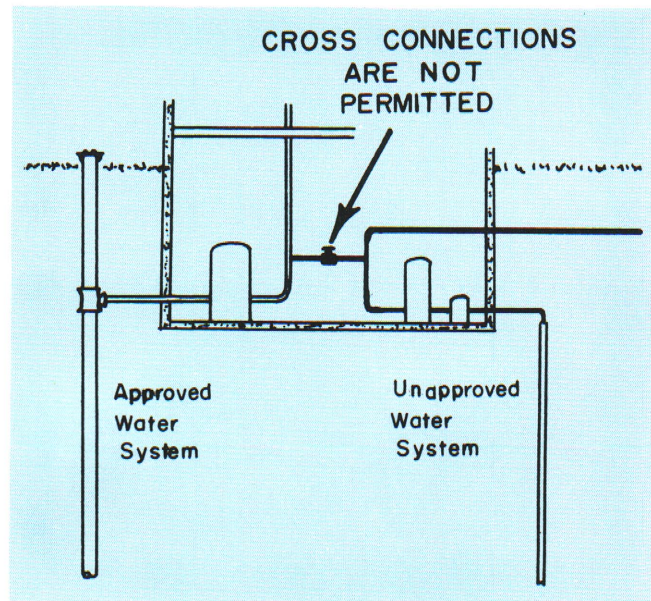

Fig. 12. Connections between approved and unapproved water systems are not permitted.

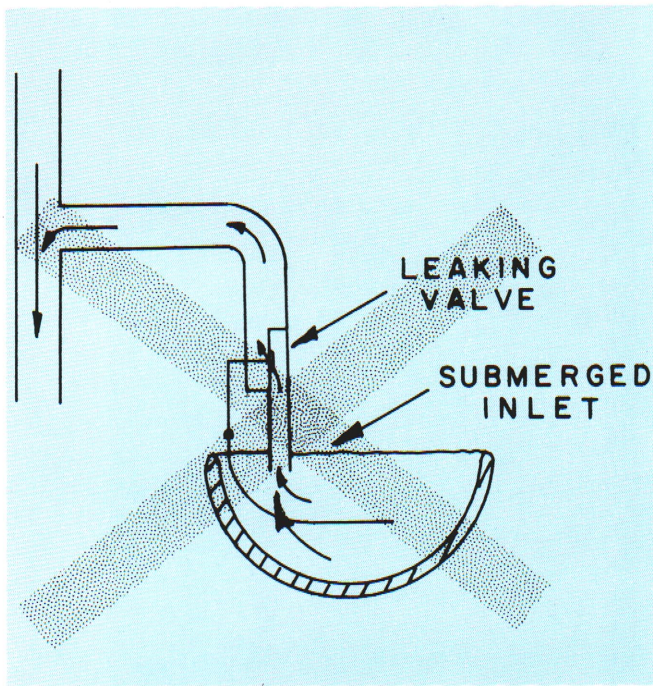

Fig. 13. Stock watering equipment with submerged inlets is NOT approved.

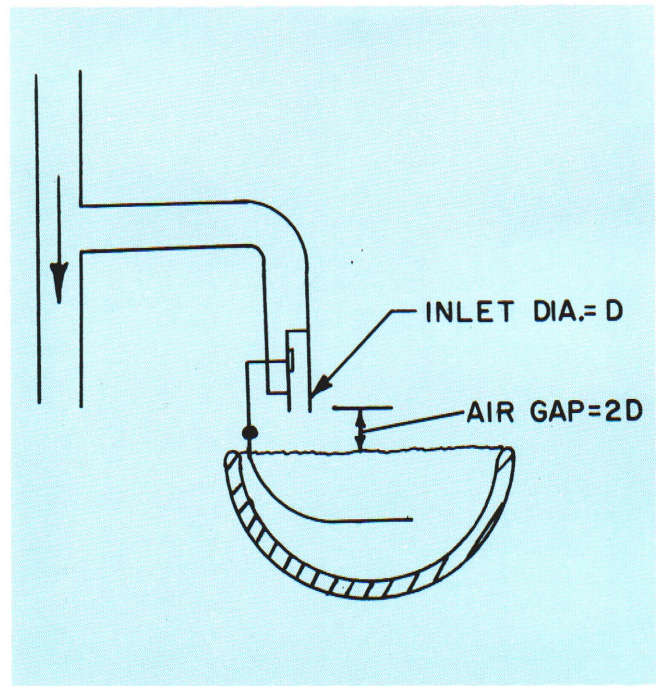

Fig. 14. Stock watering equipment with an air gap meeting these standards is approved.

Additional information regarding grade A dairy farm water systems can be obtained from the state milk inspector in your area, or the Dairy Division of

the Michigan Department of Agriculture in Lansing 48913. Approval of a water system is valid only when issued by the appropriate authorities.