

THE UNIVERSITY OF MICHIGAN LIBRARY



FILE COPY
DO NOT REMOVE

Your Furniture Selection Series

III
WOOD FURNITURE



Michigan State University
Cooperative Extension Service
Extension Bulletin 504
Home and Family Series

III

WOOD FURNITURE

Wood furniture offers you an excellent opportunity to individualize your home, whether your budget is large or small. This is partially due to the many woods, finishes, and styles readily available to you. However, it is very important to choose wisely and keep purchases in harmony with your other furnishings.

Today's furniture is designed for today's houses. As a result most of it is relatively small in scale. Also many pieces are quite versatile. For instance, there are chests of drawers which look well in the bedroom, living room or den. Several can be combined with shelf units to make a room divider or storage along a wall. Tables can be adjusted in size or combined with other tables to fit changing needs.

Wood furniture is often called "case goods". Case goods furniture includes dining and bedroom furniture, any furniture with doors or drawers, and coffee tables and end tables.

You'll probably want to look for characteristics in wood furniture such as these: *Kind of wood; type and quality of finish; good construction; quality of materials; depth and number of drawers; versatility; pleasing design; ease of maintenance.*

Furniture is no better than the design, quality of materials, construction, and finish.

by Glinda B. Leach



Figure 1—Hardboard used for veneer cores and dust panel.

WOODS

Hardwoods are preferred for most case goods. These are woods from trees which lose their leaves in winter. Popular hardwoods are walnut, mahogany, oak, maple, cherry, birch, and gum. Birch and gum are often used to resemble other woods. Excellent hardwoods used less often are teak, satinwood, myrtle, chestnut, and beech.

Softwoods are from evergreen trees with needlelike leaves. The most popular softwood furniture is pine. Softwoods generally are actually softer. However, southern yellow pine is harder than chestnut or gum.

Metal or plastic may be combined with wood for reason of construction or style. Any metal used should be rust resistant. If it is painted or enameled it should be resistant to chipping.

The less expensive woods are commonly used for interior parts of furniture. This practice results in lower cost and often greater strength.

Sometimes processed woods are used to definite advantage. These woods are often called hardboard. They are very acceptable for backs of case goods, veneer cores, dust panels and drawer bottoms (Figure 1). They are inexpensive. In addition, some are highly resistant to moisture and very strong.

It is sometimes difficult to recognize all woods after the surfaces have been finished. Often a tag tells the kind of wood and/or finish. A tag stating that the wood is genuine indicates that solid wood has been used for the frame parts and veneer for the larger surfaces. A tag stating that the wood is solid means that all exposed surfaces are made from wood at least one-fourth inch thick (Figure 2).



Figure 2—Genuine Walnut—Solid walnut used for frame parts and walnut veneer for the larger surfaces. Solid Walnut—All exposed surfaces made from walnut at least one-fourth inch thick.

Veneer or Solid

Furniture of varying qualities can be made from either solid or veneered wood. Neither is wholly superior

to the other. Hardwoods are used for both. In fact, hardwoods may be used as solid wood, veneers, or plywood cores for veneers.

Veneer has been used for many years, often in very expensive furniture. Today manufacturers are using it more than ever before. This is mainly because of new improved glues. It is used where matching or contrasting pattern is important or where strong lightweight construction is desired.

Veneer or plywood construction is bonded wood "sandwich" usually consisting of three, five, or seven layers (Figure 3). The center or core of the sandwich can be solid lumber or other type wood. On each side of the core thin sheets of strong hardwood are placed at cross grain. The top, face, or front veneer is of selected fine hardwood.

Almost all wood frames and legs are made of solid wood. Construction methods to prevent warping, twisting of solid wood vary with the manufacturer and quality of furniture.

Figure 3—Veneer or plywood construction. Arrows indicate direction of grain.

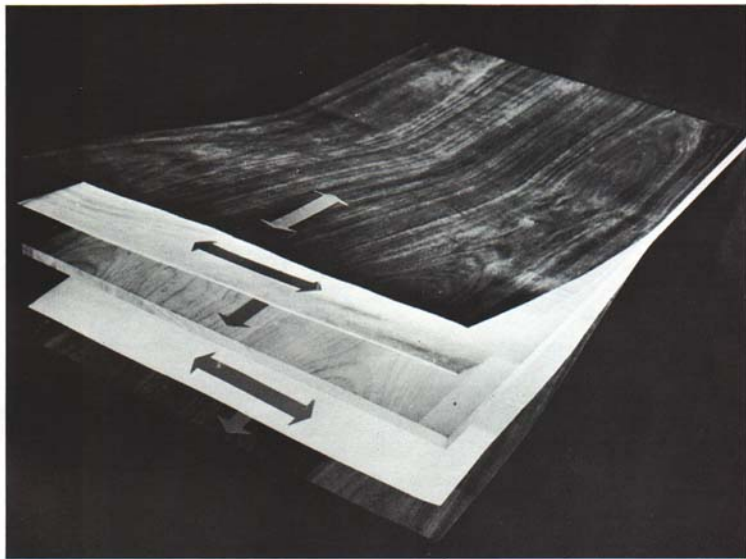

Advantages of veneer (Figure 4):

- Maximum strength in furniture.
- Lightweight furniture construction.
- High resistance to warping, checking, and swelling.
- Striking grain effects. Grain easily matched.
- Suited to simple or compound curve construction.
- Allows use of more costly wood for face layer than if the same were solid wood.

Advantages of solid wood (Figure 5):

- Easily carved, repaired or refinished.
- Shows natural grain to beautiful advantage.
- Edges do not show layer effect.
- Wood surface does not loosen or peel off.
- Pride of ownership.



Figure 4—Veneer.

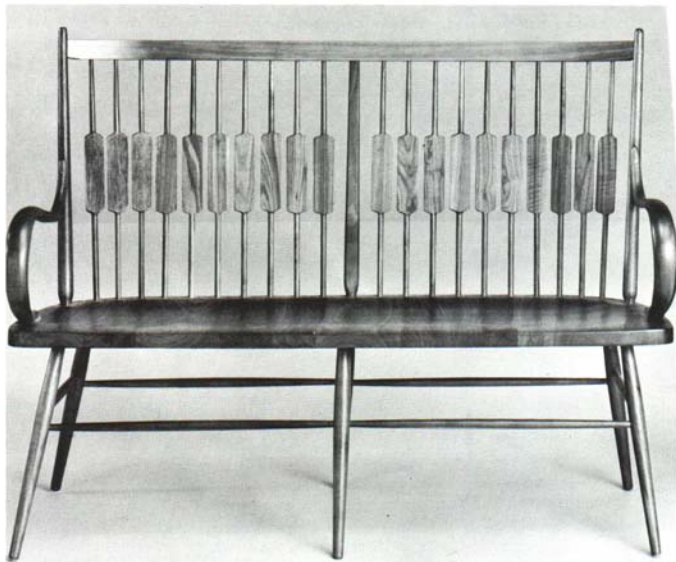

Figure 5—Solid wood.

CONSTRUCTION

In wooden furniture it is fairly easy to examine most of the construction features which indicate quality and durability. However, no furniture can be judged by its face value (Figure 6). Read informational tags. Check all parts. Ask questions about construction you cannot see.

Frame

The frame of case goods is usually made of solid wood. Metal or plastic may be used for special construction or style purposes.

The frame should be strong and sturdy. Tip or rock

the article and observe possible weakness in structure.

The underside should be finished to prevent swelling or shrinking.

Type of joints affects durability and appearance of furniture. They should be strong and reinforced. That is, they need to be properly joined and glued for necessary strength. Joints should be reinforced with corner blocks for additional support. Synthetic resins are stronger than animal glues. Screws strengthen joints much better than nails. This is because screws take glue well and do not split wood.

When metal is used for structural parts, joints should be securely bolted, riveted, welded, or screwed.

Figure 6—Inner characteristics of furniture determine durability.

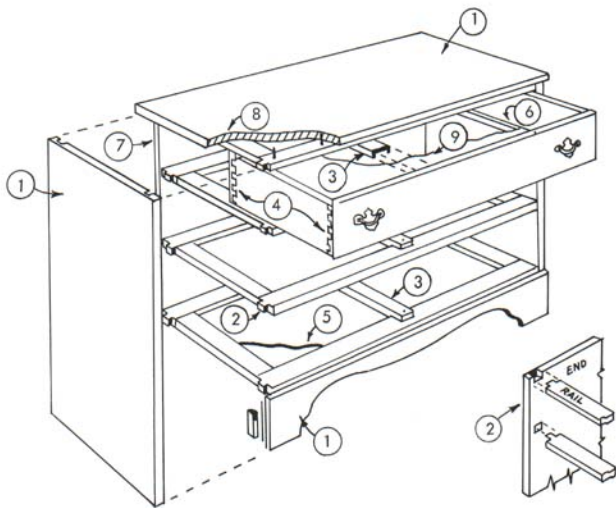

1. Selected hardwoods.
2. Mortise and tenon joints.
3. Heavy-duty center drawer guides.
4. Drawers dovetailed front and back.
5. Durable dust panels between drawers.

6. Durable drawer bottoms held rigidly in grooves.
7. Strong case backs recessed into ends.
8. Well mounted top and sides.
9. Drawer interiors sanded and sealed.



Kinds of joints vary (Figure 7):

- **Doweled joint** has wooden pegs (dowels) inserted into the holes of the adjoining piece of wood.

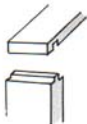

- **Tongue and groove joint** is similar to mortise and tenon. However, the tongue and groove extend the width of the boards to be joined.

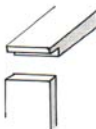

- **Butt joint** is the ends of two boards placed at a right angle. It is not strong and should not be used unless reinforced with corner blocks.

- **Rabbeted joint** has a groove cut from the edge of one piece to receive the end of the other board.

- **Dovetailed joint** has several tongues on the end of one piece designed to fit the grooves on the other. Such is used in most good drawers.

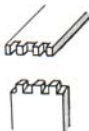
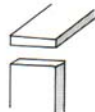

Drawers

Drawers designed to form a flush surface with the drawer opening should be neatly fitted. Exact fit is necessary for beauty and ease in use. Overlapping drawers need not be as closely fitted as flush ones because the edge of the drawer opening is concealed.

A test for a well constructed and well fitted drawer is to see if it will open evenly. Try opening the drawer by pulling on only one side or one end. It should glide in either case. Pull the drawer all the way out and examine it well. All wooden inside parts should be smoothly sanded & finished. However, the complete interior of a drawer can be of molded plastic.

Good dovetailing at all four corners is a mark of high quality in wooden drawer construction. The tongues and grooves should be well matched and glued.

Drawer bottoms should be made of solid wood, plywood, hardboard, or plastic. They should be set into drawer sides. From the underneath they should be reinforced with small wooden blocks glued with moisture-proof glue.

For smooth fit and easy use a drawer may have a center guide strip of hardwood, metal, or plastic. Such

a strip must be smooth, straight, and well attached.

Check drawers for depth. Consider what you will be putting in them. Generally the top drawers should be relatively shallow. Deep drawers encourage additional stacking which may cause unwanted wrinkles in clothing. However, they may be desirable for storage of other articles. Often a chest of drawers will have fewer drawers than its design indicates.

Dust panels between drawers should be used. 3/16-inch is a good thickness. Also, stops which keep a drawer from falling out when pulled too far are helpful.

Back

The back should be inset and screwed to the frame. In expensive pieces the back may be of the same wood as the sides and front and completely finished. But unless you are going to arrange the piece where the back can be seen this is not essential.

In most instances, you will find a hardboard or three-ply veneer back panel. It is likely to be fitted and screwed into back posts. Or in the lower priced furniture the back panel may be of cheaper woods and nailed on.

FINISH

A good finish beautifies the surface. It also protects against moisture and wear. The process includes four main steps:

- Sanding and preparing the wood surface
- Staining or bleaching
- Applying a sealer or protective coating
- Rubbing and polishing

In low priced furniture the first and last steps are sometimes omitted. However, in quality pieces the complete finishing job often involves four or five times as many steps as the four basic ones.

A good finish is smooth and free from rough spots. It is even in color and has a soft satin-like appearance. It has a rich depth called patina obtained from rubbing.

Learn to judge finish by viewing both low priced and expensive furniture. Compare sheen, patina, smoothness and color of finish. Inspect finishes in good light and look at them from different angles. Avoid a hard shine. Question a cloudy, opaque, painted look which may cover low quality wood or shoddy workmanship.

Be sure to read the label or talk to your dealer in order to become informed about both wood and finish. Many woods through finishing acquire an appearance far different from what one might expect. This is all right as long as the tag specifies that the color is derived from the finish and not the wood. Fruitwood finish means that the wood is colored probably to resemble cherry. Misleading terms to describe finish are sometimes used to direct attention away from an inferior wood.

A variety of materials are used to make wood finishes

less susceptible to damage and easier to maintain. Some are damage resistant films while others prevent change in color or surface staining. Some add to the cost, while others do not. Again, it is important to ask about special finishes. Be sure to read tags when available in order to know just what you are buying.

High-pressure laminated plastics which are used on table tops and kitchen counters are found on chests, desks and small tables. They are available in solid colors or pattern. Some laminates have a dull finish more comparable to desired wood finishes.

OTHER DETAILS

Hardware should enhance the appearance of the furniture in design, quality and beauty. It should be firmly attached and evenly aligned.

Decorative details should be truly decorative. Inlays, marble tops, and intricate carving can add to beauty but increase the cost as well.

When casters are used they should roll easily, evenly, and smoothly.

READY-TO-FINISH FURNITURE

Case goods furniture is available unfinished and even unassembled. Pieces are usually relatively low in price. However, they are often well styled and well made (Figure 8). Either hardwood or softwood can be selected. The wood should be kiln-dried and surfaces smoothly sanded. Look for even grain and simple styling without intricate details.



Figure 8—Ready-to-finish chest of drawers. Walnut.

YOUR COMPARISON CHECK LIST*

WOOD FURNITURE

High Quality	Medium Quality	Low Quality
<u>Design:</u> Excellent line and proportion. Decoration a part of structural design.	<u>Design:</u> Less attention to fineness of line and proportion.	<u>Design:</u> Sometimes of good design. Often monotonous proportions. Sometimes over decorated.
<u>Woods:</u> Best grades of woods. Solid or veneer. Great care in seasoning and manufacture to control moisture in the wood.	<u>Woods:</u> Varying grades of the better woods. Solid or veneer. Woods suited to climate and kiln-dried.	<u>Woods:</u> Usually softwoods.
<u>Construction:</u> Expert labor. More hand processes. Strong glue. Perfectly fitted joints. Glued, screwed and reinforced. Plywood used where needed for strength and beauty.	<u>Construction:</u> Skilled labor. Strong glue. Well-fitted joints. Reinforced braces screwed or nailed and glued.	<u>Construction:</u> Unskilled labor. Cheap glue. No dowel or dovetailed joints. Parts poorly fitted and glued. Nails used.
<u>Finish:</u> Highly sanded. Permanent stains. Many coats of high-grade varnish or lacquer. Proper treatment between each coat. Last coat well rubbed. Underneath and back well finished.	<u>Finish:</u> Well-sanded. Good staining. Several coats of medium grade varnish or lacquer. Some hand rubbing. Roughness seen on edges of some pieces. Underneath and back reasonably well finished.	<u>Finish:</u> Poorly sanded wood. Unnatural color in stains. One or two coats of cheap varnish or varnish stain sprayed on. Poorly sanded surface.

*Characteristics of high, medium and low qualities will overlap. There is no sharp dividing line between adjacent qualities.

Additional References

Books

- Inside Today's Home*, by Ray and Sarah Faulkner, 1960, Macmillan.
Art in Everyday Life, by Harriet and Vetta Goldstein, 1958, Holt.
How to Decorate and Light Your Home, by E. W. Comery and C. Eugene Stephenson, 1955, Coward McCann, Inc.

Circulars

- Design Your Family Living Pattern*, Ext. Cir. 695, University of Missouri.
Sharpen Your Shopping Skills, Ext. Cir. 749, University of Missouri.
Your Furniture Selection Series, University of Missouri.
 No. I, Before You Buy, Ext. Cir. 751.
 No. II, Upholstered Furniture, Ext. Cir. 752.

Acknowledgments

We gratefully acknowledge permission given by the following to use photographs appearing in this circular: American Walnut Manufacturers Association, Fig. 2. Baumritter Corporation, Fig. 6. Country Workshop, Fig. 8. Drexel Furniture Co., Fig. 4. Fine Hardwoods Association, Fig. 3. Herman Miller, Inc., Fig. 5. Kroehler Manufacturing Co., Fig. 1. National Association of Furniture Manufacturers

Issued in furtherance of cooperative extension work in agriculture and home economics, acts of May 8, and June 30, 1914, in cooperation with the U.S. Department of Agriculture. George S. McIntyre, Director, Cooperative Extension Service, Michigan State University, E. Lansing, Michigan.