

U. S. GOVERNMENT BULLETIN ROOM FILE COPY FOR LOAN ONLY

FILE COPY

FARM KITCHENS

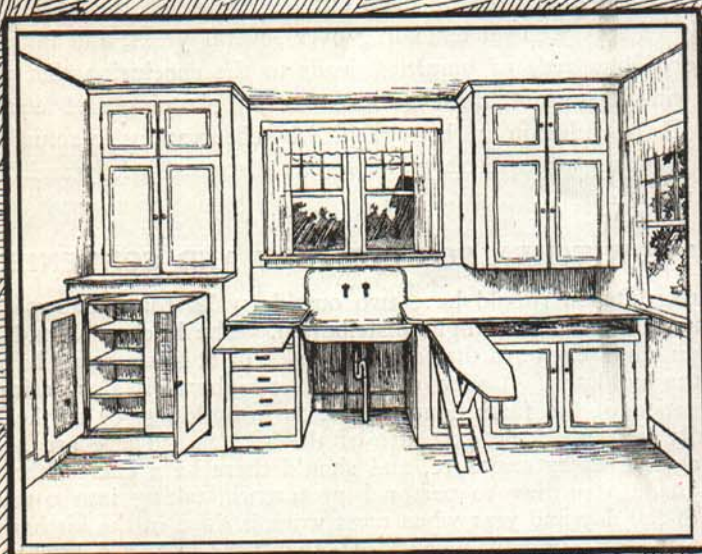

MICHIGAN AGRICULTURAL COLLEGE
EXTENSION DIVISION
R. J. BALDWIN, DIRECTOR

FARM KITCHENS

F. E. FOGLE

Assistant Professor in Agricultural Engineering
and

MARIAN ROGERS SMITH

Household Management Specialist

Farm women are coming to recognize the fact that to do comfortably the work required of them their kitchens must be conveniently arranged and well equipped. It is not, however, generally understood how to make a satisfactory plan or to remodel or re-arrange a kitchen to make it convenient.

A satisfactory plan can result only from a careful study of the conditions and requirements in each individual case, and the application of correct rules and principles in working them out.

A study of this problem extending over several years, and involving the answering of hundreds of inquiries, leads to the conclusion that there are definite principles which must be followed in planning and equipping a kitchen. This conclusion has been verified by observations in actual kitchens.

In the following pages these principles are discussed briefly and illustrated by kitchen plans.

LOCATE KITCHEN FOR COMFORT AND CONVENIENCE

The farm kitchen should have two outside walls for windows to insure cross-ventilation and good light distribution. The kitchen should be on a corner of the house toward the farm buildings, or at least should have a clear view of the buildings. A view of the public highway is also desirable.

The relation of the farm house to the farm buildings or to the highway will usually determine the exposure of the kitchen. There are arguments for and against every exposure, and should there be a choice, the decision must be made according to personal preference, taking into consideration the time of the day and year when most work is done in the kitchen and the amount of direct sunlight received at that time. A hot kitchen in the summer, during the part of the day when most work is done, is especially to be avoided.

CONVENIENT TO BASEMENT AND REST OF HOUSE

While the kitchen is the center of activities in the farm home, its work is closely associated with the dining room, the cellar, the storeroom and the woodshed. These should be grouped as closely as possible to save steps and time. The stairway to the second floor, the laundry room, and the bedroom, where small children must frequently be cared for, should also be within easy access of the kitchen. The house should be planned, if possible, so that a person coming from out-of-doors could reach the dining room and other parts of the house without going through the kitchen. A study of the floor plan shown in Fig. 1 will reveal these features.

A COMPACT KITCHEN SAVES STEPS

A farm kitchen used only for the preparation and clearing away of food and washing dishes need not be larger than 9' x 12'. A small, compact kitchen, with working processes brought closely together, saves steps, has less wall and floor space to clean, and costs less to build.

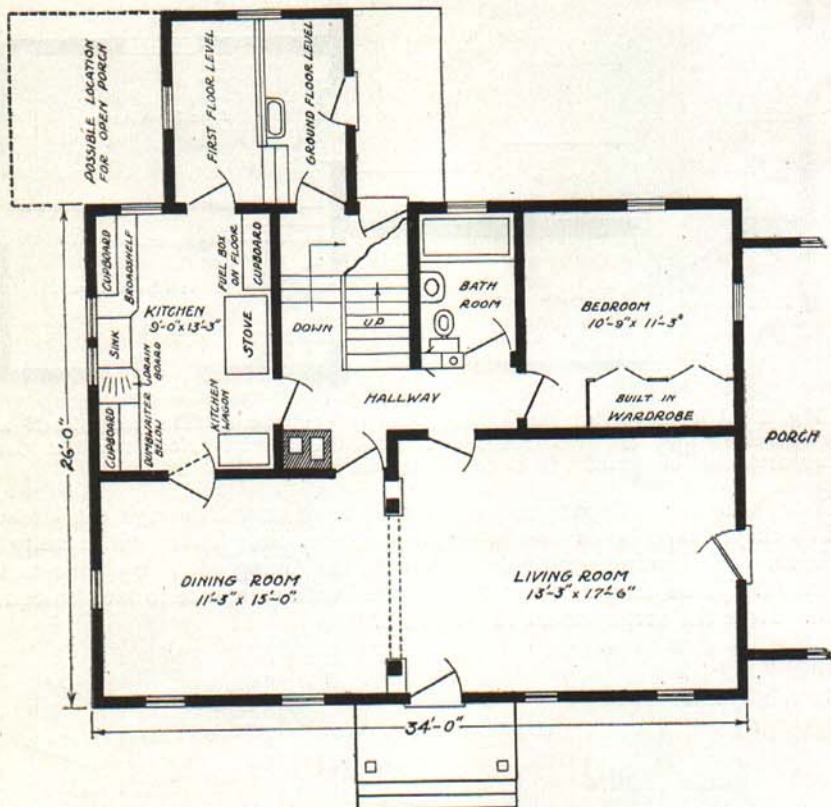

Fig. 1. A well arranged, compact floor plan showing good arrangement of kitchen as related to other rooms, basement, and second story.

If meals are eaten in the kitchen, and if it is necessary to do the washing or other work than preparing food there, the size must be larger. The equipment, however, should be grouped together in order to avoid steps. A small kitchen with dining alcove is preferable to a large kitchen in which there is a dining table centrally located.

The kitchen should be oblong rather than square. The oblong kitchen gives more wall space, and the equipment is brought closely together when placed along the two long walls.

HAVE FEW DOORS WELL LOCATED

The convenience of a kitchen depends greatly upon the location of the

doors. The floor plan of the house will determine to a large extent the number and location of the doors.

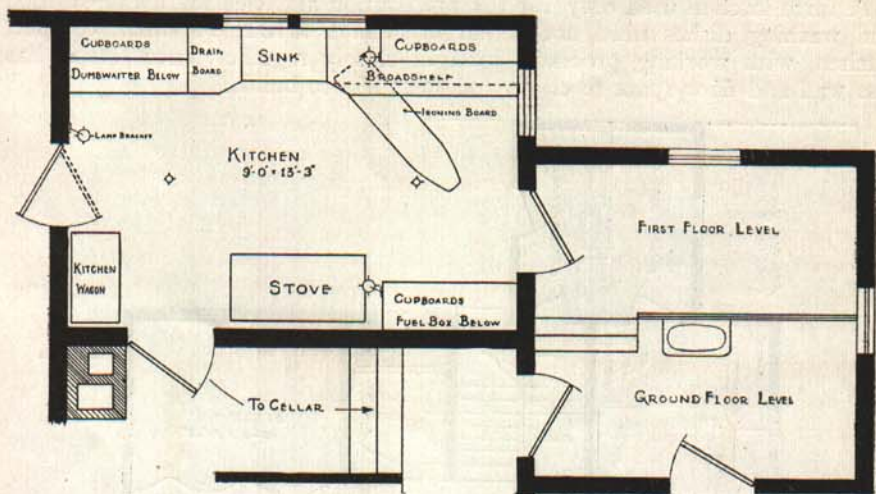

Fig. 2. A compact kitchen having built-in equipment. The work shelf and sink are close together, with the range but a step away. Note that the dumbwaiter and dish cupboard are close to the dining room.

Doors take up wall space and establish lines of travel through the kitchen, and so they should be as few in number as possible. Three will usually be sufficient—one leading out of doors, one to the dining room, and one to the basement. These should be carefully located with reference to kitchen equipment. Note the arrangement in Figure 2.

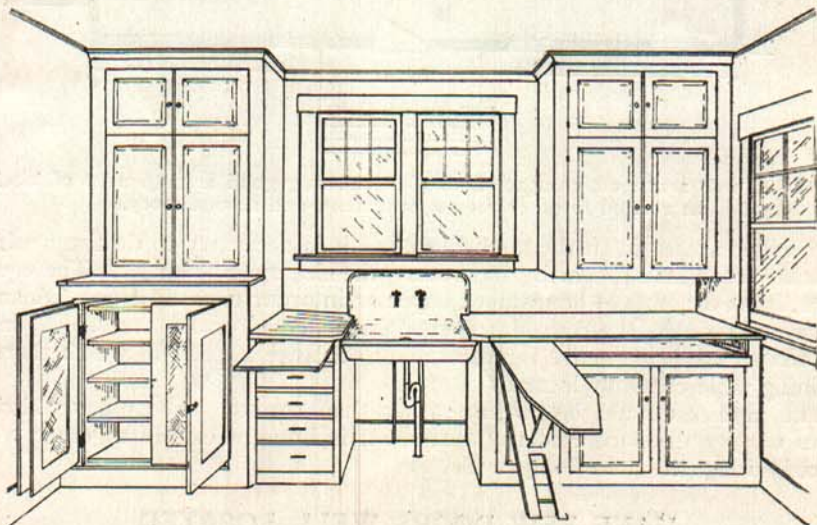

Fig. 3. A perspective view of the built-in equipment in the kitchen floor plan shown in Figs. 2, 4, 5, 6.

The door between the kitchen and dining room should swing both ways so that it can be easily opened with both hands full.

AMPLE LIGHT FROM WELL DESIGNED WINDOWS

One square foot of glass area to five or six square feet of floor space in the kitchen will give ample light. The windows should be placed at least 32 inches high to permit equipment being placed under them, and higher if they are over a sink. Windows should be grouped rather than located singly, in order to give more unbroken space for equipment. Glass in the rear door will lessen the window area necessary.

There is no best type of window for the kitchen. The common check-rail window is probably best suited in the majority of cases. The window which swings out complicates screening, while the window which swings in, unless carefully designed, will be in the way and inconvenient.

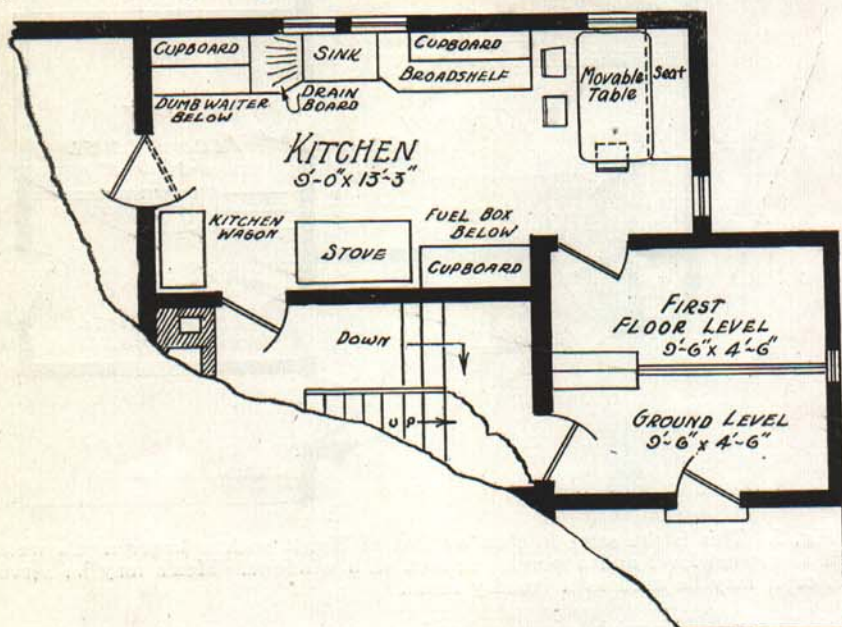

Fig. 4. A variation of the floor plan shown in Fig. 2. A breakfast nook has been added and the enclosed back room shifted so there is no outside cellar door.

DO NOT WORK IN YOUR SHADOW

The kerosene bracket lamp with reflector can be placed to throw light where needed, one lamp serving for several brackets. Note location of brackets in Fig. 2. If electricity or gas are available, an indirect lighting fixture in the center of the ceiling, with wall lights, will be found best.

A GOOD FLOOR ADDS TO ATTRACTIVENESS AND SAVES LABOR

The ideal kitchen floor should be non-absorbent, smooth, silent, easy to

clean, wear-resisting, comfortable and non-slippery, as well as attractive in appearance. There are differences in opinion in regard to the best material for the kitchen floor. Maple, birch, and beech are the most satisfactory woods if the floor is not covered. They are all close grained, smooth, durable woods and take an oil or varnish finish well.

Probably the least expensive from the standpoint of durability is a hard-wood floor treated with boiled linseed oil. Wood floors may be oiled, painted, waxed or varnished. Paint is quite satisfactory over a floor that is discolored and shows wear. It cannot be repaired without mottled appearance as it shows wear in spots. The whole surface must be repainted. Wax is attractive for kitchen floors and is easily renewed. Water discolors wax, but a new application will remove the stain. The objection to wax is the fact that it must be renewed and re-polished often, as well as the fact that

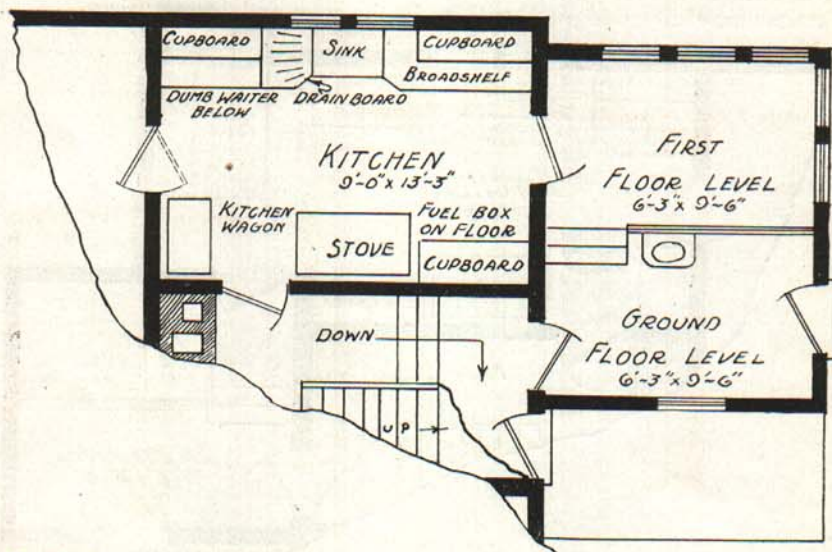

Fig. 5. This is the same kitchen as that of Fig. 2, with a larger men's wash-room at ground level and a porch enclosed with windows. Meals may be served here, or it may be used as a laundry room.

it is slippery. Varnish gives a hard, smooth surface, either in dull or glossy finish, as preferred. The spots that wear off under usage cannot be re-varnished without being somewhat unsightly. Linoleum has many advantages. It is easy to work on, and durable, and there are many attractive patterns to choose from. Either inlaid or battleship linoleum with an underpadding of builders felt, pasted and cemented to the floor, comes very near to the ideal.

Magnesite composition floors, built in place making one piece, are becoming popular. They come in attractive colors and may be laid with a border. If well laid so that they do not crack or chip, they are very satisfactory. With this type of floor, the baseboard may be molded of the same material, making a round, smooth corner and doing away with the joint between the floor and the baseboard. Such floors should be laid by an experienced and competent workman.

INTERIOR FINISH SHOULD BE ATTRACTIVE AND EASY TO TAKE CARE OF

The cupboards and interior woodwork may be finished either in the natural color with a waterproof varnish or enameled. The varnished surface is easier to clean, but darkens with age. Enamel comes in many attractive colors, and may be selected to harmonize with the walls. Securing a satisfactory finish depends upon careful preparation of the wood and the use of correct undercoats fully as much as upon the surface coat.

There are three methods of surfacing the plaster walls of a kitchen to make them sanitary and readily cleaned. Waterproof paper is the cheapest sanitary covering. It is easily cleaned but not long-lived. Paint made for the purpose is easily applied and durable, and is most satisfactorily applied over hard plaster. It is hard to clean when applied over rough plaster. Oil-cloth carefully selected for color and pattern and well applied comes very close to the ideal. An occasional coat of floor varnish or spar varnish will add to its life.

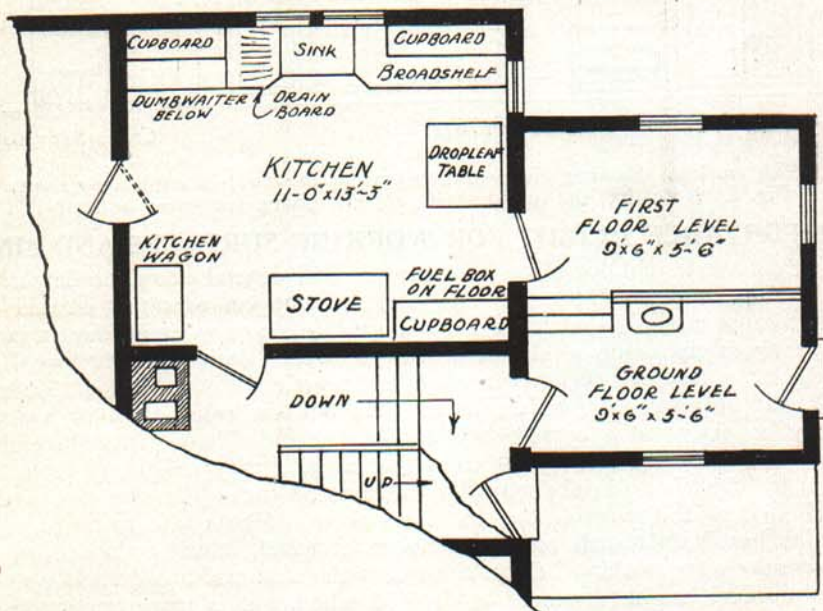

Fig. 6. A kitchen like that in Fig. 2, but two feet wider, giving room for a table where meals may be served.

PLENTY OF CUPBOARDS FOR EQUIPMENT AND SUPPLIES

"Built-in" cupboards are very satisfactory for storage space in the farm kitchen. They should extend from floor to ceiling to give maximum storage space and to prevent dust collecting either above or below. In planning cupboards, space should be provided for food, cooking utensils, cleaning materials, supplies and dishes.

Maple or birch, finished in the natural color with a high grade, heat and waterproof varnish, makes an attractive broad shelf, but one which deteriorates quickly unless given careful attention. Battleship or inlaid linoleum

cemented to soft wood can be highly recommended. The linoleum should be finished with at least two coats of spar varnish.

Shelves in a dish cupboard should be adjustable as to height. The dimensions on the cupboard plan shown in Fig. 7 are considered good.

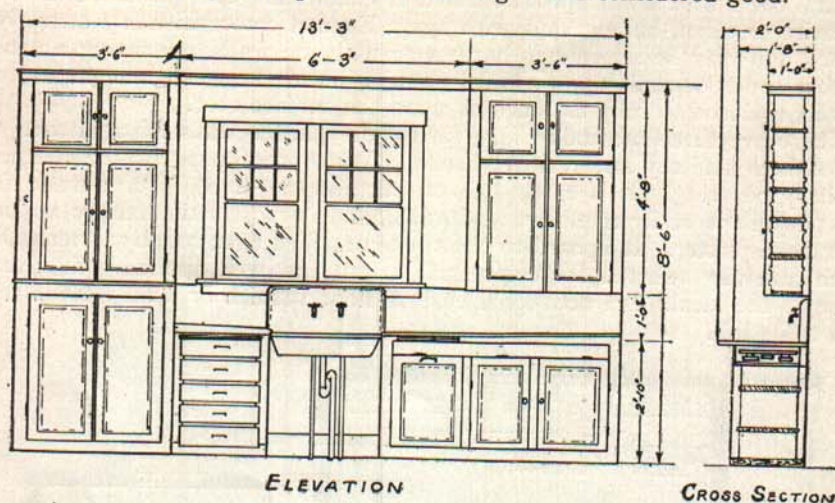

Fig. 7. A working drawing giving dimensions of the built-in cupboards shown in Fig. 3. Note that the broad shelf projects, giving toe space beneath.

COMFORTABLE HEIGHT FOR WORKING SURFACES AND SINK

The correct height for a working surface will depend upon the height of the worker and the nature of the work. Some consideration should be given to appearance, as a kitchen looks more ship-shape when all the surfaces are at about the same level. A working surface with a height equal to *one-half the worker's height* is good for practically any kind of kitchen work. If only one person is to work at a built-in broad shelf or a sink, it may be placed at a correct height for that individual. But since this would be a rare case, it would seem that an arbitrary height of from 32 inches to 34 inches (in the majority of cases 34 inches) to the top of the broad shelf or to the inside bottom of a sink would be a safe rule. In case the sink has drain boards or broad shelves attached, it will be necessary to compromise on a working height, since both the sink and broad shelf cannot be at an ideal height. It must be decided whether it is more important to have the working surface or the sink bottom at the proper height. Since more work is done on the broad shelf and it is possible to raise a dishpan or other utensils used in the sink to the correct height by means of a pan or wire frame, it would seem wise to place the top of the broad shelf 32 inches to 34 inches high. Any except an extremely short or an extremely tall woman would find such a working surface convenient and comfortable.

CRYING NEED OF THE FARM KITCHEN

Every kitchen should have a sink, with running water, provided with suitable means for carrying away waste water. It is believed that this will be found the greatest labor saver among all single pieces of equipment. When the sink has drain boards or work shelves on either side as shown

in Fig. 2, it must be placed somewhat lower than the ideal height in order that the working surfaces will not be too high.

A KITCHEN WAGON SAVES STEPS TO DINING ROOM

Setting the table and clearing away the dishes is usually accomplished by numerous trips from the kitchen to the dining room table and return. This may be done with one or two easier trips with a kitchen wagon, which can be rolled close to the work carried on. Such a wagon will also be found useful for other purposes in the kitchen.

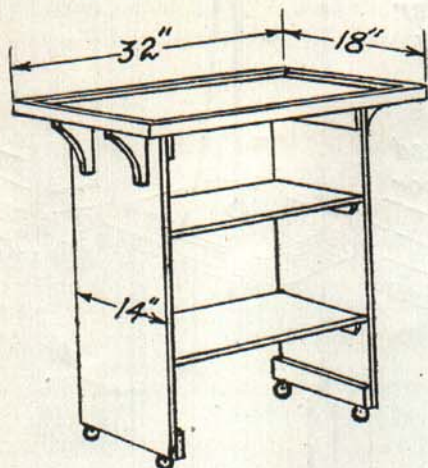

Fig. 8 illustrates a very simple, home made wheel tray which is equipped with common castors. A castor having a 3-inch wheel with rubber tire is preferable.

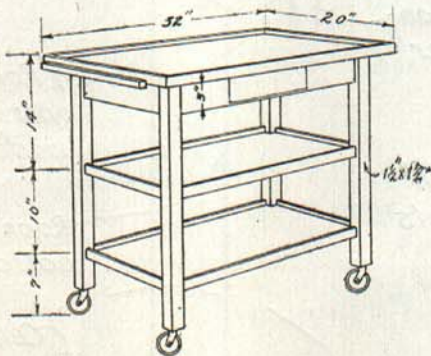

Fig. 9. The kitchen wagon shown in Fig. 9 is more carefully and substantially built, making a permanent piece of furniture. In building a kitchen wagon care should be taken to make the wheels far enough apart to insure stability, but not so wide as to prevent easy passage through doors.

A DUMBWAITER SAVES STEPS TO THE CELLAR

A dumbwaiter which will operate between the kitchen and cellar will take the place of a refrigerator in most farm kitchens, and will as well be a great step saver.

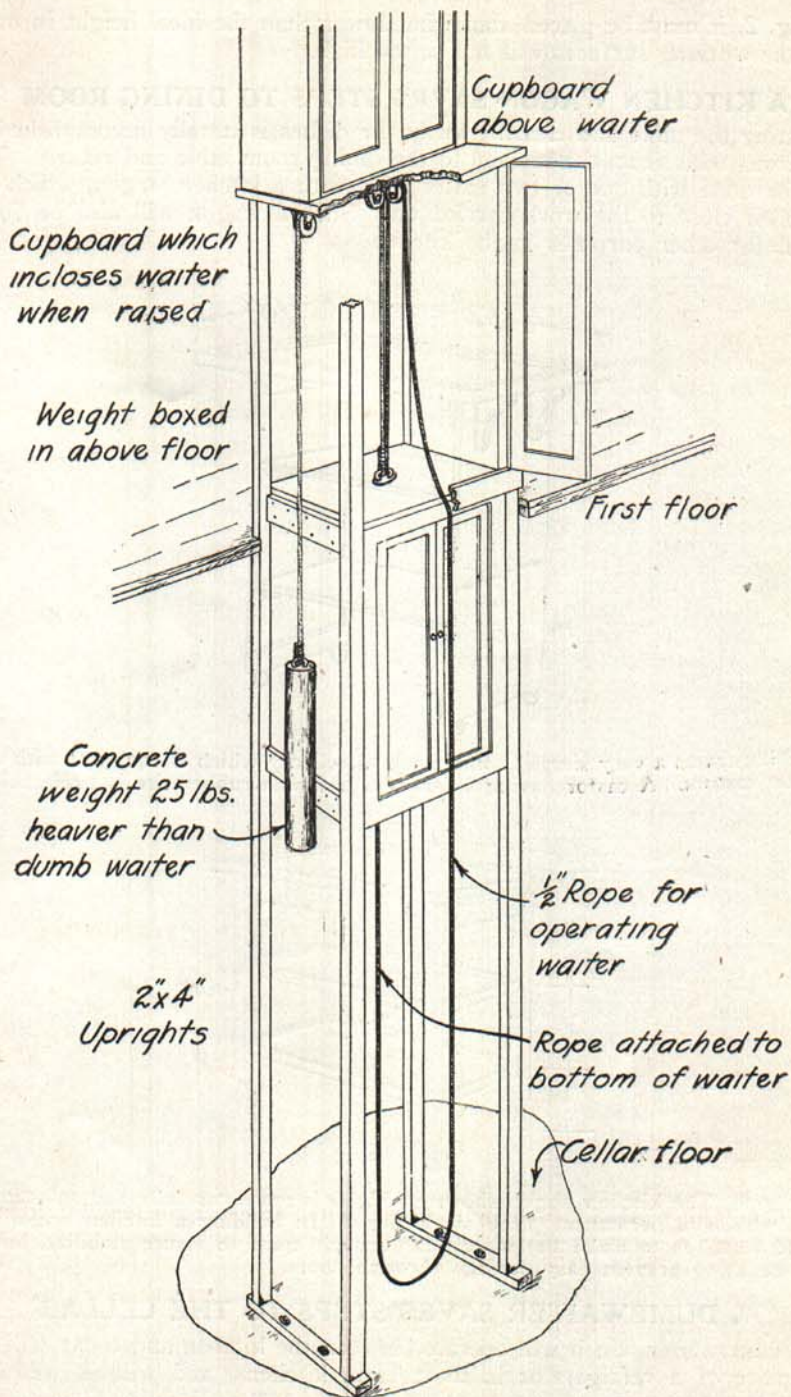

Fig. 10 shows a dumwaiter enclosed in a case. This type is very satisfactory and can be installed by the local carpenter.

The dumbwaiter is a simple, inexpensive piece of equipment. It is one of the greatest labor savers in the farm kitchen and should be more generally used.

A PLACE TO KEEP FOOD COOL

A ventilated cupboard with openings at top and bottom so that the outside air can circulate through, may be used during many months of the year if placed on the north side of the house. A "cold box" built on the outside of the lower sash of a window may be used as a substitute. See Fig. 11.

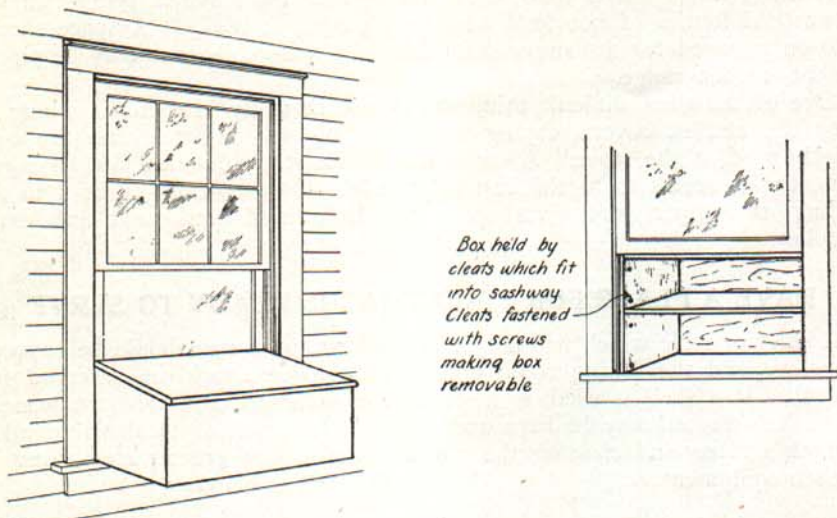

Fig. 11. A box for food attached outside a window will save many steps during the cool months.

GROUP EQUIPMENT FOR EACH KIND OF WORK

Convenience for (1) preparation, (2) cooking, (3) serving and (4) clearing away meals is of first importance in a kitchen.

KEEP FOOD MATERIALS CLOSE TO PREPARATION AREA

For preparation of food, there must be storage provided for large and small quantities, cupboards for equipment, and a broad shelf or table for working.

Storage of large quantities of foods is especially important in the farm kitchen. Such a cupboard built in the kitchen itself, instead of a pantry, and located near the outside door will result in the greatest saving of steps. By building the bins below the work shelf, and extending the cupboards to the ceiling, sufficient space may be planned. A commercial cabinet with added cupboards built around it may be used if desired. Space must be reserved in these cupboards for all utensils used in mixing and baking. The broad shelf or working surface is usually a part of such a cupboard.

Perishable food supplies should be kept as near as possible to the working

unit. If kept down cellar, the door should be easily accessible. If a dumb-waiter or cold box is used, it should be near this group.

STOVE FOR WORKING SHOULD BE NEAR PREPARATION AREA

The stove must be as near as possible to the preparation center, preferable to the right of it. In the majority of Michigan farm homes this will be a wood or coal range, and so a box for fuel must be near. The fuel box may be built in and filled from the outside, or placed on castors so that it may be pulled to the door to be filled without bringing dirt into the kitchen.

If a fireless cooker is used, it should be near the stove in order that hot stones and kettles of hot food may be placed in it easily. A space should also be reserved for the summer oil stove, or a low oil stove may be placed on the kitchen range.

One of the most difficult things to decide in many kitchens is where to keep the kettles, covers, frying pans, stirring spoons, etc., that are constantly used at the stove. A cupboard by the stove planned just to house these things seems to be the best solution of this problem. If built to the ceiling, the upper part gives space for little used equipment and extra supplies.

HAVE A PLACE FOR FOOD THAT IS READY TO SERVE

A shelf or table which will not be injured by hot things should be between the stove and the dining room door. This space should be reserved for serving. If a shelf is used, make it high enough so that a table on wheels, or kitchen wagon, may be kept under it, which proves of incalculable value in both serving and clearing the table. There is no greater step saver in kitchen equipment.

AN INVITING PLACE TO WASH DISHES

Ask a woman what she dreads most in her kitchen and nine times out of ten she will answer, "dish washing." A convenient unit for clearing away and washing dishes will rob the process of most of its terrors. A sink and drainboards, with dish cupboards near by, are the essentials. As most women wash dishes from right to left, the shelf or drain board for stacking before washing should be at the right. If only one drain board can be used put it at the left, so that the dishes may be placed upon it for drying. As near as possible to this drain board should be the cupboard for the china used daily. This may be above the drain board or built into the dining room walls. It must be near the dining room door for convenience in setting the table.

Space for dish washing utensils and materials should be provided at the sink itself, not across the room or in the cellar way. Drawers and cupboards may often be located beneath the drainboards. If the space above the sink is not taken up by windows, a shallow cupboard or sink cabinet gives excellent place for soap, scouring powders, etc. Many small utensils may be hung on the inside of this door, or on the ledge above the sink.

Cooking utensils used first at the sink, together with knives for preparation of vegetables, should be within reach. Part of the space under the drain boards is often given to them.

IMPROVING THE KITCHEN BY REARRANGING OR REMODELING

Since a very small percentage of farm women will have an opportunity to plan and build a new kitchen, improvement must largely be made by rearranging equipment, with possibly some additions, or remodeling. Changing the location of some pieces of kitchen furniture, adding equipment, or putting in a new sink are some of the first steps that can be taken. Often a simple and inexpensive change will result in a great saving of time and labor.

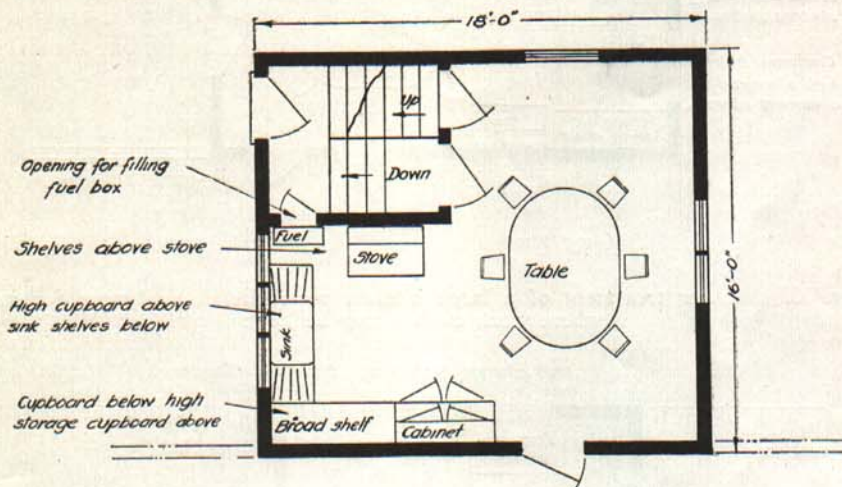

Fig. 12. A very satisfactory way of improving the large kitchen is to group the equipment, thus bringing the working processes together for the purpose of saving steps.

The possibilities of rearranging the equipment and furniture of a kitchen will depend upon the location of the doors and windows and the chimney, as well as upon the size and shape of the room. In the case of a frame house, it is comparatively inexpensive to change a door or window or to change the size and shape of a window, but it is seldom feasible to relocate a chimney, and the stove must usually be placed with regard to the chimney. In case the chimney is not well located the use of a long stovepipe will sometimes allow the stove to be set where desired. Doors and windows may be changed in walls of stone, brick, or concrete, although at considerably greater expense.

If a kitchen is not of a desirable shape or size, it may be possible to improve it by one of the following methods:

Removing a partition or changing its location.

Dividing the kitchen into two rooms, as kitchen and dining room, kitchen and bath room, or kitchen and laundry.

Putting two rooms into one to increase size.

Building an addition to increase size.

Using another room for a kitchen and making other use of the old kitchen.

Unless a partition is a bearing partition (carrying joists) it can be removed

or changed at small expense. By careful study in any given case, one may determine what all of the possibilities for improvement are.

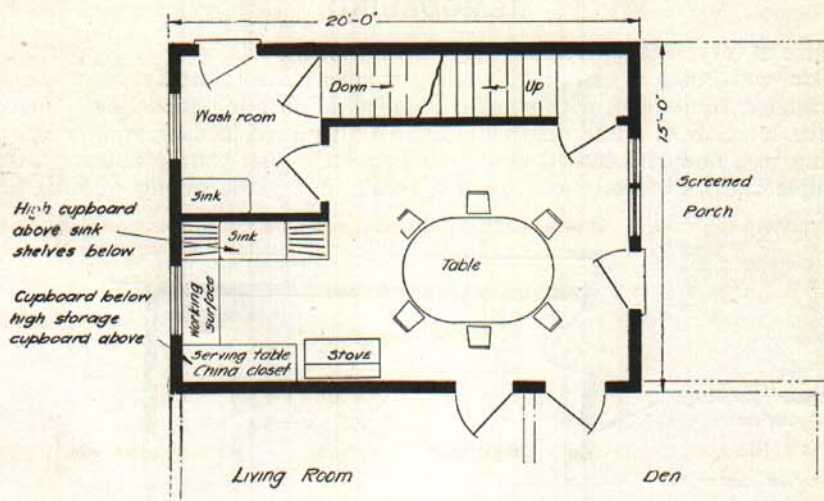

Fig. 13. Another treatment of a large kitchen permitting a washroom for men where work clothes may be kept.

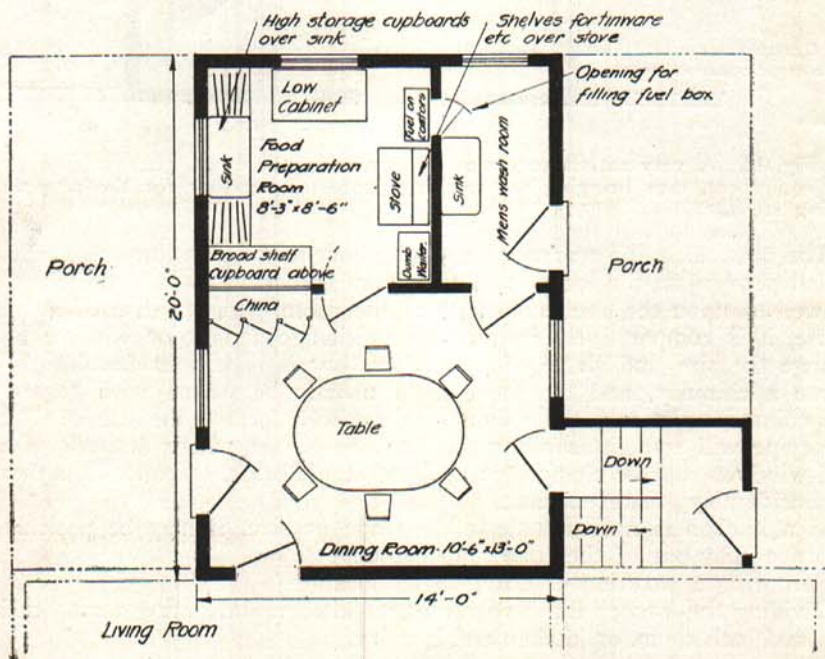

Fig. 14. A plan similar to that shown in Fig. 13, with all equipment located in a small area used only for the preparation and serving of food. Note the addition to accommodate stairs to the basement. Stairs may be built directly above these to reach the second floor.

STUDY KITCHEN ARRANGEMENT WITH CARDBOARD CUT-OUTS

The arrangement and location of pieces of equipment in the kitchen may be studied by using cardboard cut-outs. (See Fig. 15) Make an outline drawing of the kitchen to scale, letting one inch on the drawing equal one foot on the kitchen floor. For example, a 10 foot by 12 foot kitchen would be 10 inches by 12 inches on the drawing. The over-all dimensions of the

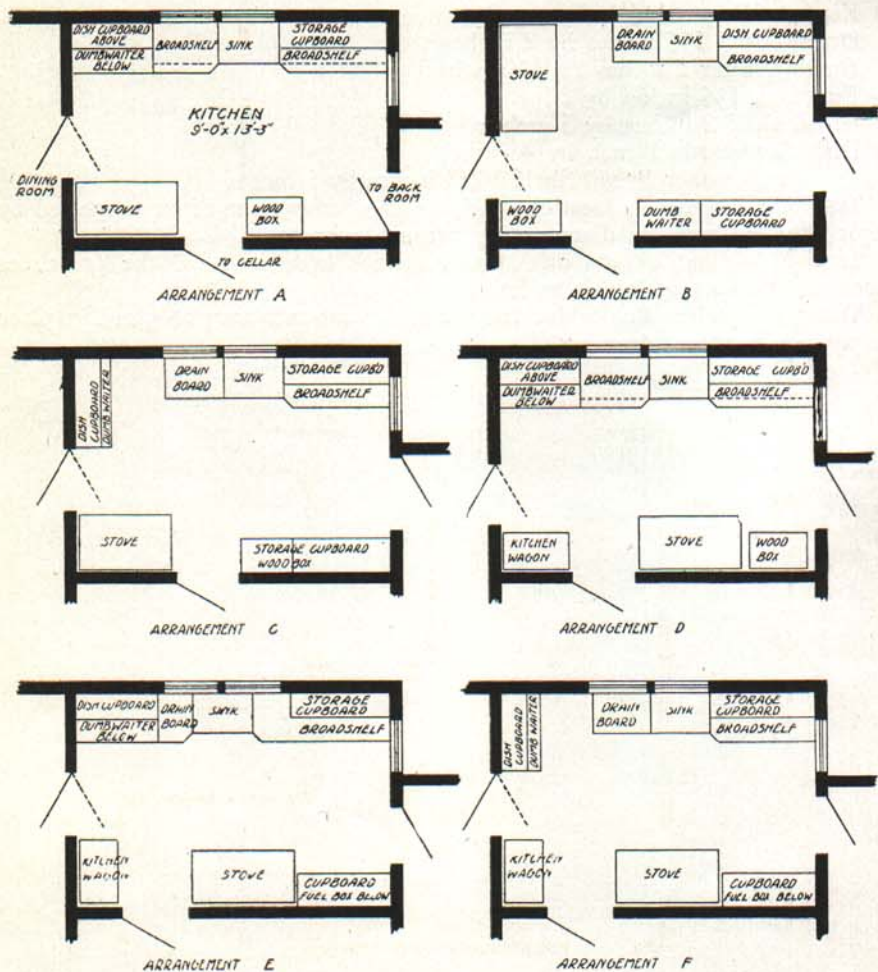

Fig. 15. The method used to plan the kitchen shown in Fig. 2 is illustrated above. Several possible arrangements of the equipment were drawn to scale, and from these, arrangement "E" was selected as being the nearest ideal. Besides the arrangements shown, many others less desirable are possible.

This figure also illustrates the use of cardboard cut-outs in planning kitchens.

kitchen equipment are secured and laid out on cardboard to the same scale as the floor plan drawing. The cardboard representing a wood range two and one-half feet by four and one-half feet would be two and one-half inches by four and one-half inches. These can then be cut out and placed on the floor plan and arranged and re-arranged until a satisfactory kitchen plan is found.

Dimensions for cardboard cut-outs may be approximately as follows:

- Wood or coal range $2\frac{1}{2}$ inches by $4\frac{1}{2}$ inches
- Oil stove $1\frac{1}{2}$ inches by 3 inches
- Sink $1\frac{1}{2}$ inches by $2\frac{1}{2}$ inches
- Kitchen Wagon $1\frac{1}{2}$ inches by $2\frac{3}{4}$ inches
- Drain board $1\frac{1}{2}$ inches by 2 inches
- Dumb Waiter 2 inches by $3\frac{1}{2}$ inches
- Fuel Box $1\frac{1}{2}$ inches by 2 inches
- Broad shelf 2 inches by 5 inches
- Dish Cupboards 1 inch by 4 inches
- Cupboards under Broad Shelf $1\frac{2}{3}$ inches by 5 inches

Desirable changes in location of doors or windows are often suggested by laying the cut-outs on, disregarding present openings.

In working out a plan one should always keep in mind the principles previously discussed in this bulletin.

When the plan is finally decided upon, the cut-outs may be glued in place to make a working drawing.