

OUTDOOR COOKERY for the family

TABLE OF CONTENTS

	Page		Page
The Fun of Planning and Preparing		Potatoes	27
Meals Outdoors	3	Baked Potatoes in Foil	27
Table 1 — Meat Buying Guide	4	Hobo Potatoes	28
Prevent Food Spoilage	4	Bundle of Potatoes	28
Cooking Terms . . . What They		Hashed Brown Potatoes	28
Mean	5	Corn on the Cob	28
Choosing Equipment for		Boiled Corn	28
Outdoor Cooking	6	Roasted Corn	28
The All-Important Fire	9	Corn Roasted in Foil	28
Wood	9	Foil-Grilled Frozen Vegetables ...	28
The Wood Fire	9	Individual Packages	28
Charcoal	9	Family Size	28
The Charcoal Fire	10	Rice	29
Ready for Cooking	12	Hobo Rice	29
Controlling the Heat	12	Rice Pilaff	29
Safety	12	Foil Cookery	29
Choosing Meat for Outdoor Cooking	13	Tomatoes and Onions	29
Table 2 — Federal Meat Grades..	14	Hamburger Picnic Bundles	29
Table 3 — Meat Cooking Methods ...	15	Fish in Foil	29
Tips on Barbecuing Meat	18	Salads	29
Using a Spit or Rotisserie.....	18	Sweet Sour Cucumbers	29
Use a Meat Thermometer.....	19	Herbed Tomatoes	30
Using a Grill	20	Blue Cheese Dip	30
Smoked Meats	21	Other Salads for the Outdoor	
Suggested Menus	21	Meal	30
Recipes	22	Desserts	30
Barbecue Sauces	22	Spiced Bananas	30
Thick Barbecue Sauce	23	Foil-Baked Apple	30
Lemon Barbecue Sauce	23	Fruit Kabobs	30
Blue Cheese Topping	23	Other Desserts for the	
Barbecue Meat Sauce	23	Outdoor Meal	31
Basting Sauce for Ribs	24	Breads	31
Basting Sauce for Chicken	24	Toasted Garlic Bread	31
Meat and Chicken	24	Hot Rolls	31
Grilled Stuffed Franks	24	Toasted French Bread	31
Barbecued Spareribs	24	Mustard Bread	31
Barbecued or Broiled Chicken..	25	Campfire Coffee	31
Chicken on the Spit	25	Clean Up	32
The All-American Hamburger..	26	The Barbecue Unit	32
Skewer Cookery	26	The Coals	32
Shish Kabob	27	Gravel	32
Other Interesting Kabob			
Combinations	27		

Figs. 1, 2, 3, 8, 9, and 10 courtesy Big Boy Manufacturing Co.

Fig. 16 courtesy Poultry and Egg National Board.

Fig. 17 courtesy National Livestock and Meat Board.

Cooperative extension work in agriculture and home economics. Michigan State University and the U. S. Department of Agriculture cooperating. N. P. Ralston, Director, Cooperative Extension Service, Michigan State University, East Lansing. Printed and distributed under Acts of Congress May 8 and June 30, 1914.

Outdoor Cookery for the Family

By ANITA C. DEAN¹ and ROBERT E. RUST²

THE FUN OF PLANNING AND PREPARING MEALS OUTDOORS

More and more families are discovering the enjoyment and pleasure of cooking food outdoors. The backyard and nearby state and roadside parks have become favorite cooking sites. A lot of traffic problems can be avoided by making your backyard a picnic ground.

Meals cooked and eaten outdoors appeal to all family members. The fresh air plus the sight and aroma of meat sizzling over the hot coals sharpens appetites. Everyone "pitches in" to make this meal a success. Most men enjoy displaying their skill as chefs, especially when they can prepare their specialties over the outdoor grill. Family and friends eagerly accept the foods served.

This cooperative preparation of food by family members — and sometimes with friends — lightens the homemaker's work. Husbands often take over part of the cooking, especially the preparation of the meat. Wives find more time to relax since they can do much of their work in advance. Children enjoy helping too. Teen-age sons can help dad with the fire and cooking, while young daughters can busy themselves with attractive table settings and centerpieces.

This is a friendly, casual way to entertain. No other method creates as much good fellowship. The hostess enjoys entertaining this way because other family members share the responsibility. Guests like the outdoor meal. They can wear comfortable clothes to enjoy a few hours of fun and relaxation. You can spend a little or a lot, just as you please, and still serve delicious food that all will enjoy. Before you invite your friends to a backyard barbecue, **make some careful plans.** Outdoor meals need as careful planning as other meals or types of entertaining. Don't short-change your family on health-giving proteins, vitamins, and minerals by just packing a basket with hot dogs, potato chips, pop, and marshmallows.

It is wise to plan only two courses. Start with a meat or main dish which can be cooked over the coals. With the meat, serve a vegetable or salad, or both, and bread. The dessert should be simple. Fresh fruits in season are a perfect choice. Don't forget the family's favorite beverage. Keep milk well chilled. An insulated bag, a chilled

¹ Extension Specialist in Foods and Nutrition.

² Extension Specialist in Animal Husbandry.

thermos bottle, or a cool brook will do the job. Fruit juices and tomato juice are good thirst quenchers. Plan a menu that will be quick to prepare and serve and easy to clean up. You will find menu suggestions in this bulletin.

After deciding on the menu, make out your market order. Be sure to allow for extra servings to satisfy those outdoor appetites (Table 1).

Now think of all the jobs you can do ahead of time, such as preparing the barbecue sauce, dessert, salad, beverage, and bread. You may want to list on-the-spot jobs and jot a name by each so everyone can get into the act.

Be sure to check your barbecue and serving tools so everything is in good condition and you have plenty of fuel. Use paper dishes or attractive pottery for serving this meal. With paper dishes, a clean-up bonfire will take the place of dishwashing.

TABLE 1—Meat buying guide

Kind of cuts	Servings, per pound*
Boneless.....	4
Medium amount of bone.....	2-3
Large amount of bone.....	1-2

*To satisfy heartier appetites, you may want to increase the size of the servings.

Prevent Food Spoilage

Care needs to be taken to prevent good food from spoiling, especially during hot weather.

Keep all perishables in the refrigerator until needed. Plan to eat soon after you arrive at the picnic spot, while the food is at its best and safest. Spoilage can occur very quickly with the right combination of warmth, moisture, and food. Avoid creamed dishes, cream sauces, gravies, custard and cream pies, eclairs, cream puffs, etc. Use special care with meat and fish salads and sandwich fillings. They must be kept cold. Sandwiches made at the picnic spot taste better and are safer than ones made at home, especially when mayonnaise or salad dressing is used on them.

Remember that all pork products should be thoroughly cooked. If your family like their hamburgers rare, use an all-beef mixture.

If you are not sure of the purity of the water supply, boil all the water that you use for 5 minutes.

COOKING TERMS WHAT THEY MEAN

- Barbecue** This simply means to roast or broil meat slowly over an open fire with a highly seasoned sauce. This term is often used to describe meat broiled over an open fire without a sauce.
- Roast** Cook by dry heat, uncovered, in the oven or on a spit.
- Baste** When a recipe directs you to baste a roast, moisten the meat with pan drippings, water, melted fat, or a special sauce. This prevents drying out or adds a special flavor.
- Braise** Braising means browning meat in a small amount of hot fat, then adding a small amount of liquid and cooking slowly in a tightly covered utensil on top of the stove or in the oven.
- Broil** Broiling refers to cooking by direct heat either in a broiler or over hot coals.
- Pan-fry** When you cook in a small amount of hot fat, you are pan-frying.
- Lard** Larding a roast means to put strips of fat in gashes made in uncooked lean meat. Slices of fat are sometimes placed on top of uncooked lean meat or fish to keep them from drying out and to add flavor.
- Marinate** Marinate by letting food stand in a liquid (usually French dressing or a mixture of oil and vinegar) to add flavor.
- Panbroil** Panbroiling means browning the meat; then cooking uncovered in a hot skillet, pouring off fat as it accumulates.
- Rotisserie** This is a device for cooking foods on a rotating spit by dry heat (over hot coals or in an oven).
- Score** To score food, cut narrow grooves or gashes part way through its outer surface.
- Toast** Toast foods by browning them lightly over hot coals or other direct heat.



Fig. 1. A simple barbecue grill.



Fig. 2. An elaborate outfit.

CHOOSING EQUIPMENT FOR OUTDOOR COOKING

Barbecue equipment can be simple or elaborate. It may range from an oven rack supported by a few stones to an elaborate unit equipped with a revolving spit, electric motor, lights and other gimmicks. (See Figs. 1 and 2.) Basically you will need:

- A container to hold the fire
- A device to hold the meat
- A hood to reflect the heat and shield the fire from unwanted drafts when cooking on a spit.

Ask yourself these questions before choosing or building barbecue equipment:

1. Is it portable?

You can use light portable equipment anywhere. If it should rain, you can move it to a protected area, such as a garage. The devoted picnicker likes to carry a lightweight folding grill in the trunk of his car. If you intend to do all your barbecuing in your own backyard, you can choose more elaborate equipment. It need not be portable.

2. Is it easy to clean?

Keeping your equipment in good condition may be a problem, if it is not made of a stainless metal.

3. Is the fire box durable?

The most durable fire box you could have would be built of fire brick. Only permanent units have this type. Sheet metal fire boxes are most common. In choosing one, be sure the metal is heavy gauge and can withstand the high heat of either wood or charcoal fires. Lightweight fire boxes burn through very quickly.

4. Is it sturdy?

Flimsy equipment can be dangerous since it tips over easily. Furthermore, if the grill itself is not secure, the meat may fall into the fire.

5. Is it the right size for your family's needs?

There are many small portable units on the market that can handle one or two steaks. These are fine for a couple going on a picnic, but are too small if you want to invite a few guests. Gauge your needs to the size group you serve most frequently.

6. Is there some way to control the heat?

Many commercial units have a device which lowers or raises the grill or the fire box. This regulates the distance of the food from the source of heat.

7. Is there some way to collect drippings?

If drippings fall directly into the fire, there will be a lot of smoke. Drippings can be absorbed by a layer of sand, gravel, or special base material in the bottom of the fire box. Some grills can be tilted to let the drip run away from the fire. In some cases you may be able to place the meat so the drip will not fall into the fire. When using a spit, do not build the fire directly underneath the meat.

8. Which accessories?

A Must

Tongs to handle the burning charcoal; a second pair for turning foods on the grill.



Fig. 3. Charcoal tongs.

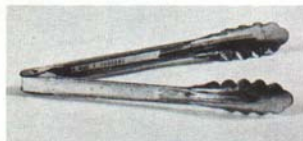

Fig. 4. Food tongs.

Asbestos padded mittens are better than pot holders when it comes to handling hot foods or equipment.



Fig. 5. Mittens.

Skewers for cooking kabobs. They may be long with wooden handles. Short all-metal ones must be handled with tongs. Heavy wire with an end looped for a handle will work.

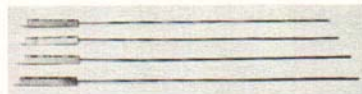

Fig. 6. Skewers.



Fig. 7. Long-handled tools.



Fig. 8. Fire rake.

Small shovel and fire rake are handy for handling the fire.

Very Handy

Hinged broiler is a set of two grills hinged together. The food is placed between them. To turn the food simply flip the grill over. Excellent for foods that break apart easily such as fish and hamburgs.

Spit baskets are designed to hold spare ribs, pork sausages, etc. They are attached to the spit. This eliminates hand turning.

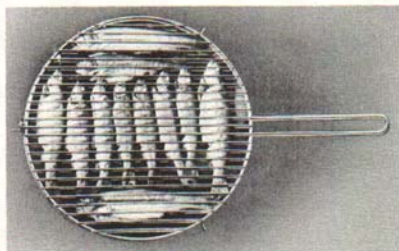

Fig. 9. Hinged broiler.

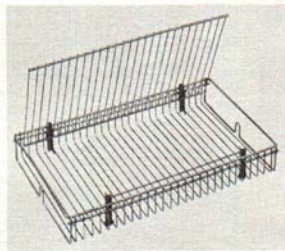

Fig. 10. Spit basket.

9. Should I buy my equipment or build it myself?

If you are an avid "Do-it-yourselfer" you will probably want to make your own equipment. However, there are several drawbacks. Your homemade equipment may not have some convenient features found on the commercial units. Furthermore, the commercial units are often cheaper in the long run when you consider the cost of the materials and services, such as welding, which you may not be able to do yourself.

THE ALL-IMPORTANT FIRE

We assume that you are abandoning the more conventional sources of heat such as gas and electricity for those fire materials which were used by our prehistoric ancestors.

WOOD

Wood, of course, is the most common fuel which comes to mind. It is easy to find and easy to light. Cooking out-of-doors has some drawbacks. You need to burn a lot of wood to get a bed of hot coals suitable for cooking. Not all woods burn well. If you are planning to use wood as a fuel, select good, dry hardwood. Softwoods usually do not produce a good bed of coals and often burn with a lot of smoke. Avoid damp or green woods.

The Wood Fire

Lighting a wood fire takes a little skill. It is best to start with some easily lighted material such as dry paper, and follow this with some small dry twigs. Once you have a good fire base started, you can keep adding larger pieces. Remember, large pieces burn slower and take longer to produce a bed of coals. Expect to spend about two hours building the fire and letting it burn into a satisfactory bed of coals.

CHARCOAL

Charcoal, is the old standby for outdoor cookery. It takes about 6 pounds of hardwood to make 1 pound of charcoal.

Charcoal is available mainly in two forms. Lump charcoal is odd-sized pieces of charcoal just as it comes from the retorts. Charcoal briquettes are made of lump charcoal that has been ground, mixed with a starch binder, and pressed into uniform-sized blocks. The briquettes will give the most uniform fire and are easier to handle.

Quality in charcoal, like quality in anything else, is very important. The best charcoal is made from the slow growing, northern hardwoods. Most of it is processed in northern Michigan. To give it good burning qualities, charcoal has to be made under carefully controlled conditions.

For best results, choose northern Michigan hardwood charcoal. The briquettes made in the Upper Peninsula are of excellent quality.

Briquettes are put up in paper bags ranging in size from five to forty pounds. You pay less for your charcoal when you buy larger-sized bags. If you are budget-minded, avoid the very small packages which are self-lighting.

Imitation charcoal products are sometimes sold. These are often difficult to light and do not provide uniform heat.

The Charcoal Fire

Lighting a charcoal fire is not always easy. Charcoal lighter fluids are the handiest to use and give the best results, or you can start charcoal with paper and kindling. If you are in a location near an electrical outlet, you can use one of the electric charcoal starters that are available.



Fig. 11. To start the fire, heap the charcoal in the fire box. A layer of gravel serves as a base for the fire. Then soak the charcoal with a charcoal lighter fluid and light it.



Fig. 12. When the charcoal is about two-thirds covered with white ash, spread it evenly around the fire box. Your charcoal fire is now ready for cooking.

To start a charcoal fire with lighter fluid, dump the amount of charcoal you will need into a heap in the fire box. Two pounds of charcoal will be sufficient for the average grill. Some manufacturers suggest using a layer of coarse gravel or a specially prepared base material in the bottom of the fire box. This will absorb the drippings and provide draft for the fire. (See Fig. 11.)

Next, soak the charcoal with lighter fluid. **Never under any circumstances use fuel oil, kerosene, or gasoline.** They are dangerous to use and produce smoke which will leave an oily after-taste on the food.

After the charcoal is thoroughly saturated, light it. It takes 20 minutes of burning before a charcoal fire is ready for cooking. This time can be shortened by supplying extra draft from a blower or bellows. With good quality charcoal you will not see any flame, just a grey ash that shows up around the edge of the charcoal pieces. When the charcoal is about two-thirds covered with this grey ash, it is hot enough for cooking. (See Fig. 12.)

Do not let the absence of flame and this innocent-looking grey ash fool you. It hides a very hot fire and many people have found

to their sorrow that any piece of charcoal showing only a tiny fleck of grey ash can produce serious burns.

Ready For Cooking

When the charcoal is ready, spread it evenly around the firebox. If you are using a spit for barbecuing, arrange the charcoal so the drippings from the spit will not fall into the fire. Usually you heap charcoal between the spit and the heat reflector hood.

Although charcoal produces an even heat, it does take some skill to keep the fire burning. Protect the grill from unwanted draft; this can cause the charcoal to burn rapidly and produce high heat in some spots. If the charcoal is burning down and you need to add more, use either started charcoal or warm up some charcoal at the edge of the fire before adding it.

One firing of charcoal should last for a couple of hours' cooking. This is enough time for the average broiling of steaks, grilling of hamburgs, or barbecuing of kabobs. For meats that need longer cooking periods, you must add to the fire from time to time.

If there is some charcoal left after you are through cooking, don't throw it away. Douse it in water or smother it in a tightly covered can. This charcoal can be re-used. Charcoal that has been burned once is hard to light. When lighting it again, mix it half and half with fresh charcoal.

Controlling The Heat

You can control the heat of a charcoal fire in several ways. A light sprinkling of water will help cool the fire. A clothes sprinkler is a handy gadget for sprinkling the fire.

Some barbecue units are equipped with grills or fire boxes that raise or lower. By changing the distance from the grill to the heat source, you can easily control the amount of heat that reaches the meat surface.

A third alternative is to add or remove coals from the fire.

If you need extra heat in a hurry, knock the accumulation of ash from the burning charcoal.

SAFETY

- Extinguish the fire completely when you are through. Small sparks left burning can start forest or brush fires or may be a danger to the next person using the picnic spot.

- Before leaving, be sure that the area beneath the grill or the fire is well soaked with water to cool it. Many people have been seriously burned by stepping on the hot ground that was left under a fire or a portable grill.
- Do not use lighter fluids on a fire that is already burning. Flare-ups from this have caused many serious accidents. Use only approved charcoal lighter fluids. Gasoline, kerosene and fuel oil are dangerous substitutes.
- Make sure all the charcoal is completely dead before you handle it. Even a small amount of grey ash on a piece of charcoal shows that it is still burning and very, very hot.
- If you are using a charcoal grill indoors, be sure there is enough ventilation. The charcoal fire uses quite a bit of oxygen, and asphyxiation could result.
- Keep children and pets away from charcoal fires. The coals look innocent enough while they are burning and may tempt some child to touch them.
- Make sure that any barbeque grill you use is set firmly on the ground so it will not tip or spill.
- Never heat canned foods in an unopened can. It may burst and cause serious burns.

CHOOSING MEAT FOR OUTDOOR COOKING

Since outdoor cooking is a dry-heat method of cooking, choose the same tender cuts of meat you would normally roast or broil. Less tender cuts need long slow cooking in moist heat.

Grade is one of your best guides in selecting beef, lamb, and veal. (See Table 2.) Table 3 will tell you the best way to cook meat according to cut and grade.

When buying beef, find out what government grade it is. If the meat is not graded, ask the retailer which grade it would fit into. Beef from the younger, more tender, higher grade animals is better suited to outdoor cookery than is beef from the older, less tender animals of lower grade. Except for tenderloins, beef of Commercial grade or lower should be used only for ground beef.

In lamb and veal, age is not a factor in tenderness since it comes

from animals under one year old. When buying be sure to get lamb and not mutton. Lamb can be identified by the break joints which are found on the legs and shanks. These differ from the spool joints which characterize the older animals. When buying lamb and veal, choose the higher grades since these will have more fat covering and are less likely to dry out during cooking.

Pork, too, is usually from young animals. When choosing pork, avoid meat with soft and watery lean or with oily fat. Pork cuts, especially pork chops, should have some marbling in them.

Freshness is very important in any meat cut that you use. Select meat that is fresh and free from spoilage. Store it properly in the refrigerator or the freezer until you want to use it. If you plan to carry meat any distance in hot weather, an iced or insulated container should be used. If meat is frozen, leave it in the freezer until you are ready to start on the trip. A frozen piece of meat, wrapped in several thicknesses of newspaper, will stay frozen for quite a long time.

One word of caution! Steaks or chops should be cut at least 1 inch thick. Thin steaks and chops will dry out too much during cooking. In the case of steaks, a thickness of 2 or even 3 inches is best. It is better to buy a thick steak and carve it into serving pieces after cooking than to buy a thin steak for each person.

TABLE 2—Federal meat grades

These are listed in order from highest to lowest grade

Beef	Lamb	Veal
Prime	Prime	Prime
Choice	Choice	Choice
Good	Good	Good
Standard	Utility	Standard
Commercial	Cull	Utility
Utility, Cutter and Canner		Cull

TABLE 3—Meat cooking methods

Name of cut	Grade	Method of cookery			
		Broil	Pan-broil	Roast on spit	*Cook in moist heat
BEEF					
Bottom round—Roast or steaks	Prime, Choice, Good, Standard				X
Top round—Roast or steaks	Prime	X	X	X	X
	Choice, Good, Standard				X
Rump roast	Prime, Choice, Good, Standard				X
Sirloin—Steak or roast	Prime, Choice	X	X	X	
	Good, Standard				X
Tenderloin—Steak or roast	All grades	X	X	X	X
Porterhouse and T-bone steaks	Prime, Choice, Good, Standard	X	X		X
	Prime, Choice, Good	X	X		
Club steak	Standard				X
	Prime, Choice, Good	X	X		
Rib steak	Standard				X
	Prime, Choice, Good	X	X		
Rib roast (rolled or standing)	Standard				X
	Prime, Choice, Good			X	
Chuck—Roast or steaks	Prime, Choice, Good, Standard				X
Flank steak	Prime, Choice, Good, Standard				X
Short ribs (boiling beef)	Prime, Choice, Good, Standard				X
Foreshank	Prime, Choice, Good, Standard				X
Hamburg	Any grade	X	X		X

*These cuts may be pre-cooked and then grilled over the coals for a few minutes before serving.

TABLE 3—Continued

Name of cut	Grade	Method of cookery			
		Broil	Pan-broil	Roast on spit	*Cook in moist heat
LAMB					
Leg	Prime, Choice, Good			X	
Loin chops or roast	Prime, Choice, Good	X	X	X	
Rack or rib—Chops or roast	Prime, Choice, Good	X	X	X	
Neck slices	Prime, Choice, Good				X
Shoulder	Prime, Choice, Good	Cubes of lamb from shoulder may be broiled			X
Shanks	Prime, Choice, Good				X
Riblets	Prime, Choice, Good	X	X		X
Ground lamb	Any grade	X	X		
VEAL					
Loin chops	Prime, Choice, Good	X	X		
Sirloin chops	Prime, Choice, Good	X	X		
Cutlets (leg)	Prime, Choice, Good				X
Leg (cubes)	Prime, Choice, Good	X			
Rump roast	Prime, Choice, Good	(if well basted)		X	X
Leg roast	Prime, Choice, Good	(if well basted)		X	X
Shoulder	Prime, Choice, Good				X
Shank	Prime, Choice, Good				X
Breast	Prime, Choice, Good				X
Ground veal	Prime, Choice, Good	X	X		
PORK (Fresh)**					
Loin chops			X		X
Blade or sirloin roast				X	X

*These cuts may be pre-cooked and then grilled over the coals for a few minutes before serving.

**All fresh pork must be cooked to the well-done stage (185° F. internal temperature). When fresh pork is well done, it will be all grey with no pink showing. Use a meat thermometer and be sure.

TABLE 3—Continued

Name of cut	Grade	Method of cookery			
		Broil	Pan-broil	Roast on spit	*Cook in moist heat
PORK (Fresh)** (Continued)					
Boston butt roast				X	X
Pork shoulder steaks					X
Picnic shoulder roast					X
Spare ribs		X	X		X
Fresh ham steak			X (if well basted)		X
Cubes of fresh pork		X			X
Fresh ham roast				X	X
Tenderloin		X	X		X
PORK (Cured)					
Smoked ham—Roast or steaks		X	X	X	X
Diced smoked ham		X			
Smoked butt				X	X
Smoked picnic shoulder				X	X
Bacon (Canadian style)		X	X	X	
Bacon (sliced)		X	X		
Sweet Pickle ham				X	
SAUSAGE					
Fresh pork**		X	X		
Bologna (ring or large)		X	X	X	X
Frankfurters		X	X		X
Smoked pork		X	X		X
Other sausage items as cooking applies					

*These cuts may be pre-cooked and then grilled over the coals for a few minutes before serving.

**All fresh pork must be cooked to the well-done stage (185° F. internal temperature). When fresh pork is well done, it will be all grey with no pink showing. Use a meat thermometer and be sure.

TIPS ON BARBECUING MEAT

USING A SPIT OR ROTISSERIE

When using a spit it is important to have the meat properly balanced so the spit turns freely and easily. This may present a problem with bone-in cuts. Therefore, it is recommended that whenever possible boneless rolled roasts be used. Insert the spit through the center of the roast. Most spits are equipped with fork-like arrangements which can be securely fastened to hold the meat from turning. Make sure the roast is well tied together so that pieces will not fall off during cooking. When you have the meat secured, check the spit by rotating it in your hands. You may have to relocate the spit if the roast is off balance. (See Fig. 13.)

If you intend to cook a whole bone-in ham, have the ham cut in



Fig. 13. This boneless rolled roast will serve a large group. An aluminum foil pan serves to catch the drippings. Note that the fire is located behind the spit, not directly beneath it.

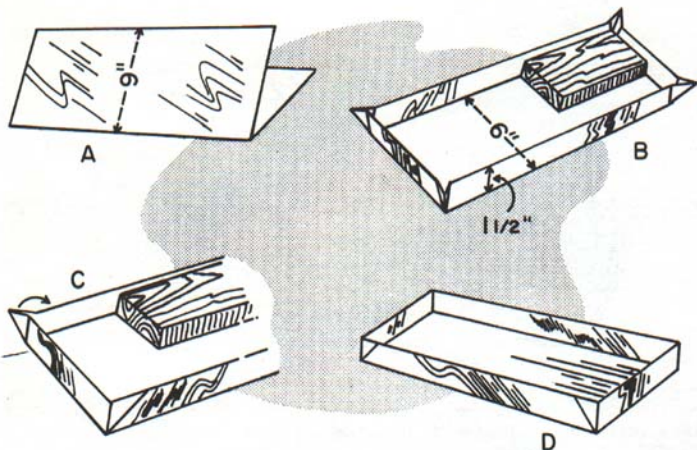

Fig. 14. A. Tear off a strip of 18-inch heavy duty aluminum foil 6 inches longer than the meat on the spit. Fold it in half lengthwise to make a double thickness.

B. Using a block of wood to make neat, square corners, form the sides 1½ inches high. Pull out the corners as shown.

C. Fold the corners back against the sides of the pan.

D. The completed drip pan will be about 6 inches wide, 1½ inches deep, and 3 inches longer than the roast itself.

two. Run the spit rod through each half but offset the two halves for better balance. Insert the spit forks and fasten them securely.

In most units the spit is arranged so that the meat will not be directly over the fire. It is best to keep the charcoal fire between the hood and the spit so that fat drippings will not fall directly onto hot coals and cause a flare-up. Place a foil drip pan underneath the roast to collect the drippings. (See Fig. 14.)

Use A Meat Thermometer

A meat thermometer is the only sure test for doneness in a roast.

- Insert the tip of the thermometer in the center of the thickest part of the roast.
- Make sure the tip does not touch the bone or rest in a seam of fat. (See Fig. 15, page 20.)

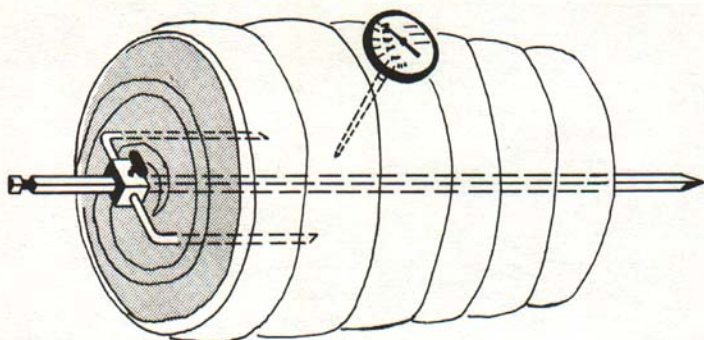

Fig. 15. Locate the point of the meat thermometer in the thickest part of the roast. Avoid touching bone, a seam of fat, or the spit.

- Check to make sure the thermometer will not catch or fall out as the spit rotates.
- Locate it so that it can be read easily.
- Make an occasional check to see that the thermometer has not loosened and is not in danger of falling out.

USING A GRILL

Cooking steaks, chops, or other meat items on a grill requires some care. If the meat tends to stick to the grill, grease it very lightly before using it. Be sure to keep the grill clean and free from specks of burned food, since these cause meat to stick.

It is best that you do not turn the meat too often since much of the juice will be lost if you do. Also, leave salt off the meat until the last minute. Salt tends to draw juices to the surface of the meat. To cut down on loss of juice when cooking steaks and chops, it is better to use a pair of tongs for turning them than to use a fork.

When making ground meat patties, press the meat firmly together so it will not break-up on the grill. Do not flatten the patties while they are cooking, or you will lose juices and flavor.

To test thin cuts for doneness, make a small slit with a knife and check the center for color.

SMOKED MEATS

For those who like a heavy smoke flavor on barbecued meat, some manufacturers make hardwood chips to add to the fire near the end of the cooking process to produce a smoke. These chips should be soaked in water before using.

SUGGESTED MENUS

Barbecued Rib Treat

Barbecued Spareribs or Barbecued Lamb Riblets
Baked Potatoes
Tossed Green Salad Toasted Vienna Bread
Tray of Fresh Fruit Homemade Cookies
Mugs of Ice Cold Milk

Steak Dinner

Broiled Steak or Broiled Lamb Chops
Hashed Brown Potatoes Chef's Salad
Toasted Garlic Bread
Foil Baked Apples
Coffee Milk

Grilled Ham Dinner

Broiled Ham Slices
Roasted Corn on the Cob
Cabbage-Green Pepper Slaw
Hot Biscuits and Honey
Coffee Milk
Fruit Kabobs

Barbecued Chicken Supper

Barbecued Chicken or Cold Fried Chicken
Potato Salad or Casserole of Escalloped Potatoes
Crisp Relish Tray or Sliced Tomatoes
Vienna Bread Milk and Coffee
Fresh Peach Ice Cream
or
Apple Pie and Cheese

Kabob Supper

Lamb or Beef on Skewers
Rice Pilaff or Hobo Rice
Sliced Fresh Tomatoes or Foil Grilled Green Beans
Hot Buttered Rolls
Milk Coffee
Chilled Canteloupe

Teen-Age Buffet

Super Hamburgers or Stuffed Frankfurters
Toasted Rolls
Potato Salad or Casserole of Quick Baked Beans
Raw Vegetable Relish Tray
Milk Lemonade
"Make Your Own" Sundaes
OR
Chocolate Cake

Rotisserie Dinner

Rolled Rib of Beef,
Boneless Fresh Ham, or Boneless Leg of Lamb on Spit
Baked Potatoes
Crisp Tossed Greens
French Dressing
Hot Buttered Rolls
Coffee Milk
Fresh Fruit in Season

Fisherman's Delight

Broiled Michigan White Fish or Trout
Lemon Butter
Hashed Brown Potatoes
Coleslaw
Vienna Bread Butter
Fresh Pineapple Spears
Coffee

Corn Roast

Barbecued Beef on Bun
Roast Corn in Husks
Sliced Fresh Tomatoes
Milk Coffee
Chilled Watermelon

RECIPES

BARBECUE SAUCES

Barbecue chefs often prepare a favorite sauce to accent the flavor of a certain meat. These sauces are used as marinades, or to baste the meat during the cooking process, or are passed with the meat at the picnic table.

Here is a collection of sauce recipes. Vary them to suit your taste. Fix them ahead of time and store until needed. A narrow paint brush is handy for brushing on sauce or melted butter.

Be careful when using barbecue sauces . . . it is hard to improve the rich natural flavor of any cut of meat. Adding a highly seasoned sauce may mask the flavor of the meat. A little butter and salt and pepper may be all that is needed. You may want to rub a cut clove of garlic on the meat before broiling.

Thick Barbecue Sauce

(Good on franks, hamburgers, chicken, ribs)

½ cup onions, chopped	½ teaspoon chili powder
2 tablespoons fat or oil	¾ cup water
½ clove garlic, grated (optional)	¾ cup catsup
2 tablespoons vinegar	½ teaspoon salt
1 tablespoon Worcestershire sauce	¼ teaspoon black pepper

Brown onions in fat until lightly browned. Add remaining ingredients. Cover and simmer about 20 minutes. If sauce gets too thick, add a small amount of water. Use immediately or keep in a covered container in refrigerator until needed. Serve hot. Makes 1½ cups.

Lemon Barbecue Sauce

(Especially good for chicken, veal, and fish)

2 tablespoons onion, grated	½ teaspoon salt
½ teaspoon black pepper	¼ cup salad oil
1 teaspoon Worcestershire sauce	½ cup lemon juice
1 clove garlic (optional)	

Mash garlic with salt in bowl. Add remaining ingredients. Chill 24 hours. Makes ¾ cup.

Blue Cheese Topping

(Good on broiled lamb patties and lamb chops)

Mix ½ cup crumbled blue cheese
2 tablespoons softened butter
½ teaspoon prepared mustard

When meat is nearly broiled, after turning, top with this mixture. Broil until cheese is bubbly and lightly browned.

Barbecue Meat Sauce

(Pass at the table)

½ pound butter	½ clove crushed garlic
1 cup catsup	½ teaspoon Tabasco sauce
1 tablespoon Worcestershire sauce	Salt (to taste)
2 teaspoons dry mustard	Pepper (dash)

Melt butter. Add remaining ingredients and simmer 15 minutes. Serve hot.

Basting Sauce for Ribs

½ cup catsup	¼ cup vinegar
½ cup chili sauce	1 tablespoon sugar
2 or 3 dashes Tabasco sauce	1 teaspoon salt
1 cup water	1 teaspoon celery seed

Combine all ingredients; heat to boiling. Simmer 30 minutes. Enough sauce for basting 4 pounds of ribs.

Basting Sauce for Chicken

(Half chicken per person)

1 cup vinegar	1 teaspoon Worcestershire sauce
½ cup cooking oil or butter	(optional)
2 cups water	3 tablespoons salt
1 tablespoon poultry seasoning	1 teaspoon pepper
1 medium onion, minced (optional)	2 bay leaves (optional)

Combine all ingredients. Heat to boiling point. Enough sauce for 10 servings of chicken.

MEAT AND CHICKEN

Grilled Stuffed Franks

12 frankfurters	2 dill pickles
Prepared mustard	½ pound bacon, sliced thinly
¼ pound Cheddar cheese	12 frankfurter rolls

Cut frankfurters lengthwise, almost through but not quite, and spread cut sides with mustard. Slice cheese and pickles into long strips and lay a strip of each in the frankfurters. Wrap a slice of bacon around in spiral fashion, fastening the ends with toothpicks. Arrange frankfurters, cut side down, on broiling rack and broil 4 to 5 minutes or until bacon is crisp. Turn and broil 5 minutes longer or until cheese starts to melt. Tuck into hot rolls and serve.

Barbecue Spareribs

Allow ¾ to 1 pound of ribs per person.

Spareribs must be cooked to the well done stage. Allow 1½ hours for barbecuing. You can shorten the cooking time by about one third by partially cooking the ribs beforehand. Parboil for about 1 hour, or pressure cook about 20 minutes. Finish cooking on the grill. Allow 30-40 minutes for this final grilling.

On the spit: For best results, lace ribs on the spit accordian style or place in a spit basket. Arrange foil pan to catch drippings. Do not baste with sauce until ribs are almost done. Then baste constantly the last 5 minutes of cooking.

On the grill: When barbecuing ribs on the grill, space briquettes ½ to ¾ inch apart to avoid flame-up. Turn every 2 to 3 minutes, basting every time they are turned. When done, slice ribs apart, transfer to a hot platter, and brush generously with sauce.



Fig. 16. Barbecued chicken highlights an outdoor meal.

Barbecued or Broiled Chicken

Use a small dressed chicken weighing $2\frac{1}{2}$ pounds or less. Have the chickens split in half lengthwise and break joints so they will be as flat as possible. Skewer wing and leg to body.

Season each half chicken with about $\frac{1}{4}$ teaspoon salt and $\frac{1}{16}$ teaspoon pepper. Brush with melted fat and place on grill skin side up at least 7 inches from coals. Cook slowly (1 to 2 hours, depending on distance from heat). Turn and baste often.

Baste with melted fat or basting sauce every 5 or 10 minutes or often enough to prevent burning. Cook until meat is very tender. The leg bone will turn easily in the socket when the chicken is done. A cut into the thick muscle of the drumstick should reveal no pink color.

Chicken on the Spit

Use whole broiler fryers weighing 2 to 3 pounds each. Season body cavity with salt and pepper. Arrange chicken on spit rod, balancing carefully.

Run spit rod through the breast parallel to the backbone; bring it out through body opening. Center chicken on rod; attach holding forks in breast and tail areas. Tie or skewer wings to body. Tie tail to spit rod. Cross legs and tie to the tail.

If barbecuing more than one chicken, fasten others on spit in same way, using a holding fork for each and placing birds close together. Tighten spit fork screws with a pair of pliers. Insert thermometer in breast of chicken.

Brush birds with oil or melted butter. Season with salt and pepper. Attach the spit and start the motor. Place drip pan under the chickens. Broil about 6 to 7 inches from fire. During last 10 minutes of cooking, baste with drippings or melted butter. Chickens are done when thermometer registers 190° F. Allow $1\frac{1}{2}$ to 2 hours for $3\frac{1}{2}$ pound chickens, 1 to $1\frac{1}{4}$ hours for smaller chickens. The meat will have pulled away from bones at the ends of the legs.



Fig. 17. The All-American hamburger — an all-time favorite.

The All-American Hamburger

(4 servings)

1 pound hamburger
1 teaspoon salt

2 tablespoons onion, chopped (optional)
1 teaspoon fat

Combine hamburger, salt and onion. Lightly shape into 4 to 6 patties. Panbroil in skillet or broil. Do not press the patties while cooking.

SKEWER COOKERY

Skewer cookery is spectacular and always delights guests. If possible, let each person construct and grill his own kabob. It can be the highlight of your meal.

Make kabobs by alternating chunks of food on skewers. Use meat and vegetables which will cook at the same time. This may mean some vegetables such as potatoes and onions have to be partially cooked. Or give each vegetable its own skewer so you can remove each from the heat at the right time. Before broiling, season with salt and pepper, and brush with barbecue sauce or melted butter

and lemon juice. Chunks of meat will cook faster and more evenly if they are not crowded.

To serve, point skewer down and slip the food onto plate, platter, or into a hot roll.

Shish Kabob

Cut 2 pounds of tender lamb into 1½ inch squares. Remove fat and gristle. (Allow ½ to ¾ pound of boneless meat for a serving.) Marinate meat cubes in a mixture of your choice, or brush lightly with melted butter and a little lemon juice while broiling. Season with salt and pepper. Meat can be marinated for several hours or overnight. Place in the refrigerator while marinating. Thread 4 to 6 lamb cubes on a skewer taking care not to overcrowd. Broil 3 inches from coals, turning to brown evenly. Cook about 15 to 20 minutes. You can use tender cuts of veal, beef, or pork instead of lamb.

Marinade I

(2 pounds meat cubes)
½ cup salad oil
1 teaspoon salt
¼ teaspoon pepper
1 teaspoon marjoram
2 teaspoons lemon juice

Marinade II

(5 to 6 pounds leg of lamb, cubed)
2 tablespoons salad oil
1 tablespoon salt
½ teaspoon pepper
1 teaspoon oregano
½ cup dry cooking sherry
½ pound sliced onions

Other Interesting Kabob Combinations

Beef steak, mushrooms, sliced onions
Ham, pineapple, orange sections
Luncheon meat, quartered tomatoes, small cooked onions
Bologna, onion, bacon
Brown-and-serve sausage, mushroom, bacon, tomato
Meatball wrapped in bacon, green pepper, onions
Ground sausage, apple wedge
Salami, pineapple chunks, bacon
Raw shrimp, scallops, bacon square
Beef sirloin or veal steak, cooked tiny onions, fresh tomatoes, mushrooms
Franks, canned pineapple, or apple chunks, bacon squares
Franks, spread with mustard, pickle chunks, cooked tiny potatoes, tomato wedges
Calves liver or chicken livers, small bacon squares, mushroom caps
Luncheon meat, pineapple, banana chunks
Ground lamb shoulder, tomatoes, green pepper, onion
Ground beef balls, tomatoes, green pepper, onion
Lamb cubes, sliced bacon, mushrooms, tomato wedges

POTATOES

Baked Potatoes in Foil

Wrap each scrubbed baking potato in foil.* Place it right on the glowing coals. Bake 1 hour or until done, turning occasionally. Cut a cross on top, pull back foil, and insert butter. Serve in foil wrapping.

*Use double thickness of regular foil or use heavy duty foil.

Hobo Potatoes

Scrub baking potatoes. Place in coffee or shortening can. Cover loosely and bake on grill over hot coals about 1 hour and 20 minutes. Cut a cross on top. Season with butter.

Bundle of Potatoes

Place thick slices of potato on a 10-inch square of well greased aluminum foil.* Season with salt and pepper, add 1 tablespoon of butter and a few slices of onion. Wrap it tightly, twisting ends. Bake on hot coals or on grill for 45 minutes.

Hashed Brown Potatoes*

4 peeled cooked potatoes	1/8 teaspoon pepper
1 to 2 tablespoons grated onion	3 tablespoons butter
1 teaspoon salt	

Grate cooked potatoes on coarse grater. Add onion, salt and pepper, and mix lightly. Press into large individual patties. Melt butter in heavy skillet and lightly brown potato patties on both sides. Serve hot. Serves 4 to 6. You can wrap each potato patty in foil and cook them on the grill or the coals. Add a little butter to each package.

CORN ON THE COB

Boiled Corn

Husk corn. Cook in boiling salted water 5 to 6 minutes on top of grill. Serve hot.

Roasted Corn

Pull back husks of corn and strip off silk. Replace husks and tie ends with string. Line ears up on the grill over hot coals. Roast corn for 15 to 20 minutes, turning frequently, until husks are dry and browned. Soak in cold water before roasting to prevent excessive browning.

Corn Roasted in Foil

Remove husks and silk. Spread corn with butter, salt and pepper. Wrap tightly in aluminum foil, twisting ends to seal.* Roast over hot coals or in a hot oven (400° F.) 15 minutes to 30 minutes, turning several times.

FOIL-GRILLED FROZEN VEGETABLES

Individual packages: Arrange single portions of frozen vegetable on one-half of a square of aluminum foil.* Add salt and pepper, and dot with butter. Fold other half over top and crimp edges to make a sealed envelope. Place on grate over fire or directly on coals for about 15 to 20 minutes. Turn occasionally.

Family size: Place one block of frozen vegetable on one-half square of aluminum foil.* Add salt and pepper and top with a pat or two of butter. Bring edges of foil up leaving a little space for steam to expand. Seal tightly with a double fold. Place this package on grill or right in hot coals for 15 to 20 minutes. Turn occasionally.

*Use double thickness of regular foil or use heavy duty foil.

RICE

Hobo Rice

Place 1½ cups of water and ½ teaspoon of salt in a pound-size coffee can. Heat to boiling over the coals on grill. Remove from heat and add one 5 ounce package (1½ cups) of precooked rice. Stir just to moisten. Cover can lightly with lid and set at side of grill away from heat. Let stand a few minutes (5-13 minutes) to fluff. Season with butter, salt and pepper. Makes 3 cups. Serve with shish kabobs.

Rice Pilaff

3 cups rice
¼ pound butter

6 cups chicken, beef, or lamb broth
Salt and pepper to taste

Melt butter in heavy skillet. Add rice. Braise well until butter begins to bubble. Add broth and seasonings. Stir well. Transfer to casserole or place covered skillet in oven. Bake at 375° F. for 30 minutes. Remove from oven, stir well, and return to oven for another 10 minutes. Serve hot. (Pilaffs are to Armenians and Near Easterners what potatoes are to Americans.)

FOIL COOKERY

Tomatoes and Onions

Cut medium sized, firm tomatoes in half crosswise, and season with salt and pepper. Place a thin slice of onion between the halves. Fasten with a toothpick and wrap each tomato in a 6 inch square of heavy aluminum foil. Bake at edge of hot grill for 15 to 20 minutes. Delicious with broiled ham or grilled fish.

Hamburger Picnic Bundles

Place a well-seasoned beef patty in the center of a 10-inch square of aluminum foil*; top with a teaspoon of steak sauce or chili sauce. Cover meat with thinly sliced potatoes, carrots, and onions. Season generously with salt and pepper. Add 1 tablespoon of water. Fold the foil up loosely around the food. Seal tightly. Toss into hot coals for about 20 minutes, or bake in hot oven (450° F. for 30 to 40 minutes).

Fish in Foil

Place clean, fresh fish on a piece of aluminum foil. Add a slice of bacon, seasonings, and a little water. Fold foil and place the packet in the coals. Be careful not to puncture the foil. Bake 10 to 12 minutes until done, turning once or twice. Do not overcook. For additional flavor, add chopped green pepper and chopped onion.

SALADS

Sweet Sour Cucumbers

3 cups peeled, sliced cucumbers
1½ cups sliced onions
2/3 cup vinegar

½ cup sugar
1 teaspoon salt
¼ teaspoon pepper

Mix cucumbers and onion slices in bowl. Blend other ingredients and pour over vegetables. Chill at least 1 hour.

*Use double thickness of regular foil or use heavy duty foil.

Herbed Tomatoes

½ cup salad oil	¼ teaspoon marjoram
2 tablespoons wine vinegar with tarragon	½ teaspoon salt
¼ teaspoon thyme	Dash black pepper
	3 tomatoes, peeled and cut in wedges

Combine first 6 ingredients. Place tomatoes in shallow bowl. Pour dressing over. Chill 2 to 3 hours, occasionally spooning the dressing over tomatoes. Drain.

Blue Cheese Dip

(Serve with crisp raw vegetable relishes)

1 - 8 ounce package cream cheese	3 tablespoons pimiento, chopped
4 ounces (1 cup) blue cheese, crumbled	½ cup green pepper, chopped
¼ cup evaporated milk	¼ teaspoon garlic salt (may be omitted)

Beat cream cheese and blue cheese until creamy. Stir in remaining ingredients. Chill until ½ hour before serving. Sprinkle with paprika. Makes about 2 cups.

Other Salads for the Outdoor Meal

Coleslaw	Crisp raw vegetable relishes:
Tossed greens	Carrots
Potato salad	Green onions
Fruit salad	Radishes
Sliced fresh tomatoes	Raw cauliflowerettes
Deviled eggs	Cucumbers
	Pickles
	Green pepper
	Raw turnips

DESSERTS

Spiced Bananas

Peel banana and place on a square of heavy aluminum foil. Brush with lemon juice; sprinkle with brown sugar; dust with cinnamon and nutmeg and dot with butter. Wrap foil securely around the bananas, twisting ends. Barbecue on grill 7 to 9 minutes or on coals 4 to 5 minutes.

Foil-Baked Apple

Core and fill apple with a mixture of cinnamon and sugar. Add either raisins, nuts, cinnamon, marshmallow, cinnamon candies, or mincemeat. Place on foil. Gather foil up over top and twist together. Bake on hot coals, turning occasionally. Allow about 1 hour for a medium size apple.

Fruit Kabobs

For a colorful tasty dessert, arrange an assortment of fruits on a long skewer and roast over the coals. Choose fresh or canned pineapple, orange sections, thick slices of banana, apple wedges and marshmallows. (Squeeze a little lemon juice over the apple and banana pieces to keep them from darkening.)

Other Desserts for the Outdoor Meal

Michigan fruits in season	Ice cream cones or cups
Cakes	Fruit tarts
Fruit pies	Cup cakes
Fresh fruit trays	Fresh fruit cup
Watermelon — half filled with melon balls and fruit	Melon (watermelon or canteloupe)
Freezer of homemade ice cream	Cookies

BREADS

Toasted Garlic Bread

Slash a loaf of Vienna bread diagonally into thick slices, cutting almost to bottom. Spread between slices and on top with garlic butter. (Add 1 to 2 cloves of mashed garlic to ½ cup softened butter. Remove garlic after 30 minutes.) Wrap buttered loaf in foil and place on grill about 15 minutes before serving. Puncture foil package to allow steam to escape. If desired, sprinkle with grated parmesan cheese or sharp cheddar cheese.

Hot Rolls

Warm buttered rolls in a large coffee can. Lay can on grill and roll frequently for even heating. Or wrap in foil and heat at the side of the grill.

Toasted French Bread

Slice loaf of French bread in half lengthwise and butter cut surfaces. Run two skewers through each half. Balance on top of cans or sticks above heat so bread will toast.

Mustard Bread

1 small loaf of French, Vienna, or Italian bread (about 15 inches long)

¼ cup butter	1 tablespoon prepared mustard
½ cup chopped green onions or sweet onions	2 tablespoons sesame seeds or poppy seeds
2 tablespoons parsley flakes or chopped fresh parsley	

Cream butter. Blend in onions and parsley. Split loaf long way. Spread with butter mixture. Spread with mustard. Top with seeds. Cut bread diagonally in 1½ inch slices not quite through crust. Heat in moderate oven (350° F.) for 12 minutes or until lightly browned or toast the bread over coals.

CAMPFIRE COFFEE

Heat 2 quarts freshly drawn cold water to boiling. Mix 1 cup regular-grind coffee, 3 tablespoons cold water and 1 slightly beaten egg. Tie loosely in a large cloth sugar sack or muslin bag. Tie ends securely with string, leaving long cord. (This may be done at home.) As soon as the water comes to a boil, drop coffee sack into water and remove pot from direct heat. Push sack up and down to force water through ground coffee. Cover and brew 12 to 15 minutes. Then lift sack out of kettle after draining thoroughly. Add ½ cup cold water to settle grounds.

CLEAN UP

THE BARBECUE UNIT

As soon as you are through cooking, pick up grills, spits, spit forks, etc. with your asbestos mittens. Wipe them quickly with a large cloth soaked in cold water. This will remove most of the grease and burned food particles. Give the equipment a final washing in hot soapy water when you get home. Store in a convenient place for the next barbecue.

THE COALS

Dump the coals that are left in a bucket of water or put in a tightly covered can to smother them. These coals can be reused (see section on charcoal fire).

GRAVEL

Put the gravel from the bottom of the fire box in an old bucket. Cool it with water if you are in a hurry.

You may want to wash and air-dry the gravel from time to time to keep it fresh and sweet.

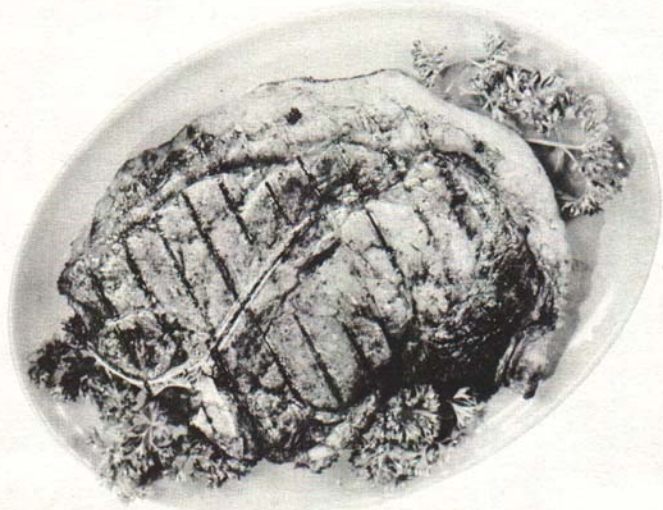

THAT'S ALL - - HAPPY OUTDOOR EATING!