

EXTENSION BULLETIN 310

PROPERTY OF
AGRICULTURAL ENGINEERING DEPARTMENT
MICHIGAN STATE COLLEGE

VENTILATION

FOR THE

Modern Dairy Barn

J. S. BOYD and R. L. MADDEX

MICHIGAN STATE COLLEGE
COOPERATIVE EXTENSION SERVICE
EAST LANSING

CONTENTS

	PAGE
Why Do We Ventilate?.....	6
Principles of Ventilation	7
Barn Construction.....	9
Determining Insulation Requirements	9
Mechanical Ventilating Systems	10
Operation	12
Exhaust Fans	12
Automatic Controls	16
Fresh-Air Inlets	16
Natural Ventilating Systems	20
The Outlet Flue	24

This bulletin revises the pamphlet, "Planning a Mechanical Dairy Barn Ventilating System," by Wiant, Boyd and Bell.

The authors wish to express their thanks to R. T. Tribble and W. H. F. Saia, who carried on research studies on barn ventilation at Michigan State College, and to the Detroit Edison Company for supplying some of the pictures used in this bulletin.

SUMMARY OF RECOMMENDATIONS

1. Design the barn to fit the dairy herd and keep it well stocked. This means a 1000-pound cow for approximately every 600 cubic feet of space. (Page 8.)
2. Insulate for temperature and condensation control. (Page 9.)
3. Wherever electricity is available, provide a complete ventilation system—including an electrically-operated fan (or fans), fresh-air inlets, and an automatic control. (Page 10.)
4. Select a fan and power-unit manufactured for the purpose of dairy barn ventilation, with a capacity of at least 60 cubic feet per minute (cfm.) per 1000-pound cow. For herds of 25 to 30 cows, or larger, use two fans; allow 80 cfm. per 1000-pound cow. Operate one fan continuously, and one on a thermostat. (Page 15.)
5. Place the fan on the side of the barn away from the direction of prevailing winds. The fan should be just below the plate, near the center of the barn (from end-to-end), and at least 10 feet from the nearest inlet. (Page 12.)
6. Place the thermostat in the center of the barn, approximately 5 feet above the floor level. Locate it where it will not be affected by extremely warm or extremely cold air. Maintain a temperature of 40° to 50° F. (Page 16.)
7. Construct fresh-air inlets spaced evenly along both sides of the barn, allowing 20 square inches of inlet-area for each cow. Inlets should be approximately 15 feet apart. (Page 17.)
8. Keep doors, windows, and hay chutes closed tightly. The ventilation system will provide the necessary fresh air and a comfortable temperature.
9. Do not try to draw warm air across the barn to warm cold areas around calf pens or cow pens.

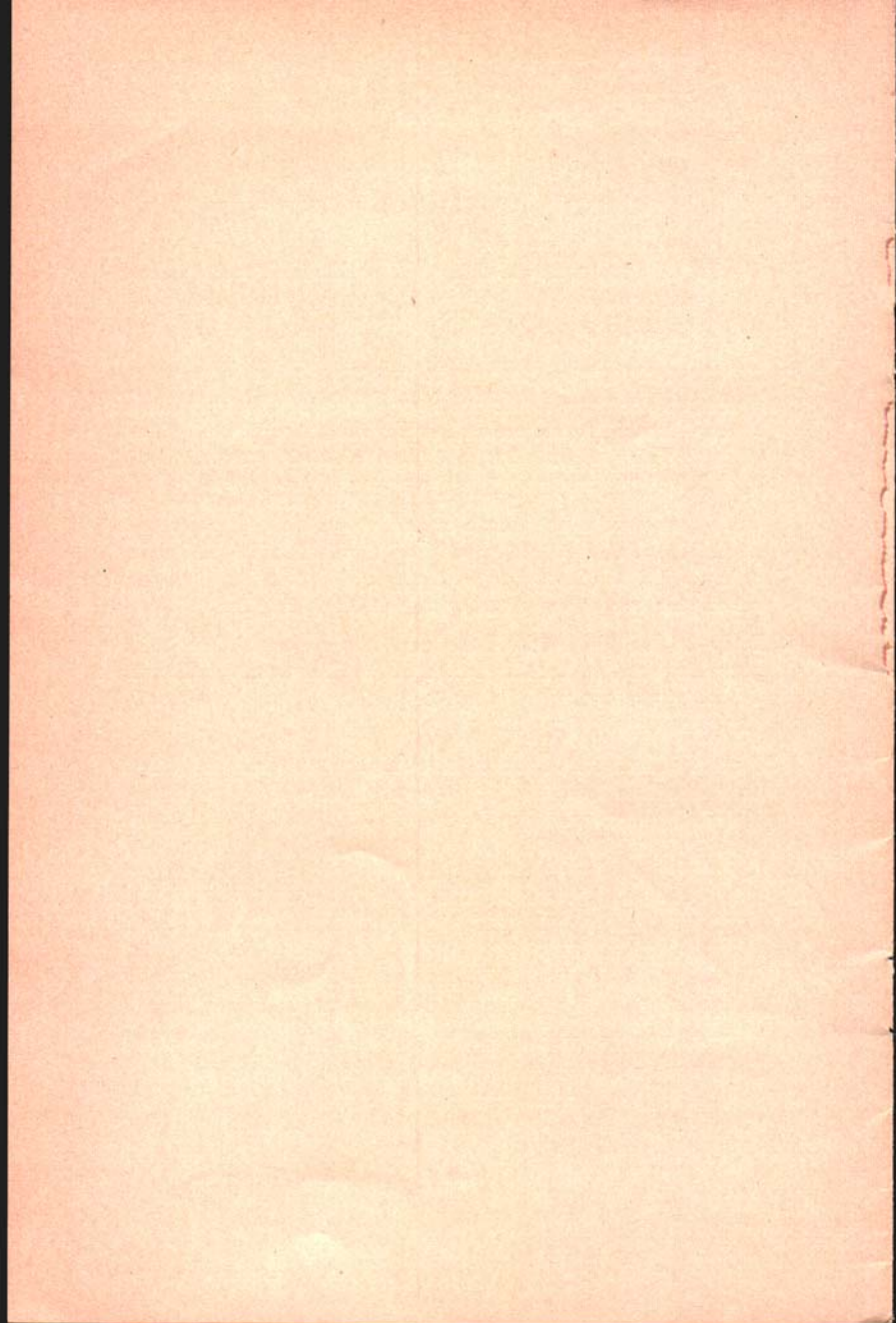

Ventilation for the Modern Dairy Barn

By J. S. BOYD¹ and R. L. MADDEX²

There was little need for any system of ventilation (other than doors and windows), when most of the older dairy barns in use today were built. In general, herds were of a size that left the cattle free to move about inside. The individual cows could keep out of the drafts and lie where they were comfortable. Also, the average production of those herds was usually at a low level—by today's standards—and "maximum" production was obtained with a minimum of expensive improvement in the structure.

However, as the dairy industry expanded and herds became larger, such barns became crowded—and the cattle had to be confined in stanchions. Since cattle so confined could no longer choose sheltered spots in which to lie, the disadvantages of the "open window" method of ventilation soon became apparent.

The dairyman—who left his barn windows properly adjusted at bedtime for anticipated conditions of temperature, wind velocity and direction—was apt to be disturbed by the sound of the wind changing in the night and the necessity for making a trip to the barn to readjust the windows. If not, he might find his cattle shivering in the morning. Or, closing all the windows on a cold evening, he might find in the morning that warmer weather had sent the thermometer up 20 degrees. The interior of his barn was then dripping wet. Throwing open the windows and doors, in an effort to correct the situation, very often exposed cattle and operator alike to severe illness.

Illness which hampers the operator in caring properly for his cattle, or sickness among the individual animals (conditions resulting from poor ventilation contribute to mastitis and pneumonia), obviously cuts into the production of any herd. Under modern dairying conditions, therefore, some system of ventilation more efficient than the open-window window method has become a necessity. Newly constructed barns usually make such provision now. For all others, this bulletin will guide individual dairymen in working out ventilating systems for their particular barns—systems which will function adequately under most weather conditions.

¹Assistant Professor of Agricultural Engineering.

²Extension Specialist in Agricultural Engineering.

WHY DO WE VENTILATE?

A good dairy barn ventilating system should do these three things:

1. Provide fresh air of suitable temperature without drafts.
2. Remove excess moisture.
3. Remove undesirable odors.

Fresh Air of Suitable Temperature Without Drafts

Usually, the amount of fresh air to be used is determined by the temperature in the barn. Cattle give off heat which must be used to keep the surrounding area warm. Any excess heat should be removed from the barn. Such an excess occurs when the heat produced by the cows is greater than the heat-loss from the barn. On warm days, this excess heat can cause uncomfortably high temperatures so that ventilation must be increased. On cold days, the situation is reversed. Provision must then be made to conserve all heat by means of insulation and good construction.

Fresh-air inlets must be placed so as to prevent strong drafts from striking the cattle; nevertheless, it is essential that there be sufficient movement to provide for a thorough mixing of the air, and to prevent "stratification."

Removing Excess Moisture

It is seldom realized how much moisture is given off by a cow through respiration. For example, a Holstein cow producing 30 pounds of milk daily will add about 18½ pounds of water to the air in a 24-hour period. During the same period, a Jersey producing 20 pounds of milk will exhale a little over 15 pounds of water.

This moisture, if not properly removed, may affect the life or usefulness of both the barn and equipment. Sidewalls and ceiling often remain wet all winter—causing sills, studs and siding to rot; paint to peel; or permitting the barn to settle (Fig. 1).

Then, too, a damp barn is a cold barn—because wet walls will conduct heat (allowing it to escape to the outside) much more readily than dry walls.

Also, in poorly ventilated barns hay chutes are often left open—permitting moisture to rise to the roof, where it condenses and freezes on. When the sun shines, this condensation melts and drips down on the hay to cause spoilage in the mow.

Removing Undesirable Odors

It is difficult to produce dairy products of good quality in a smelly, poorly ventilated barn. Such a barn is also an unpleasant place in which to work, and the odors of cattle and feed which penetrate clothing may be rather annoying when work clothes are stored in the house. These odors may not be noticeable to the dairymen, but to others they may be quite offensive.

PRINCIPLES OF VENTILATION

Ventilation is a process of exchanging foul air from inside the barn for fresh, outside air. *Temperature control* is obtained by speeding up or slowing down this exchange—which is termed *circulation*.

In extremely cold weather, it is necessary to slow down circulation to conserve heat and to keep the temperature up to at least 40°F. Relative humidity should not, however, exceed 80 percent as a rule, even in a well insulated barn. (*Relative humidity* indicates the proportion of moisture actually in the air at a given temperature, compared to the greatest amount the air could theoretically hold at that temperature.)



Fig. 1. The paint peeling under the eaves shows one of the effects of improper ventilation in this new masonry barn.

In extremely cold weather, it may become difficult to keep the barn warm enough without the relative humidity reaching the condensation point. Insulation helps to solve this problem. Insulated walls are warmer, therefore a higher relative humidity can be maintained. (Warm, moisture-laden air striking a warm, outside wall will not drop its load of moisture as readily as it will when striking a cold, uninsulated wall.)

Sufficient heat is necessary for good ventilation, and the cattle themselves supply it. There should be the equivalent of a 1000-pound cow for every 550 to 650 cubic feet of space. *Fewer cows make a cold barn; more cows make the barn hot, stuffy, and hard to ventilate.* In a well-stocked barn there will be a surplus of heat for the ventilating system to conduct out and replace with fresh, outside air.

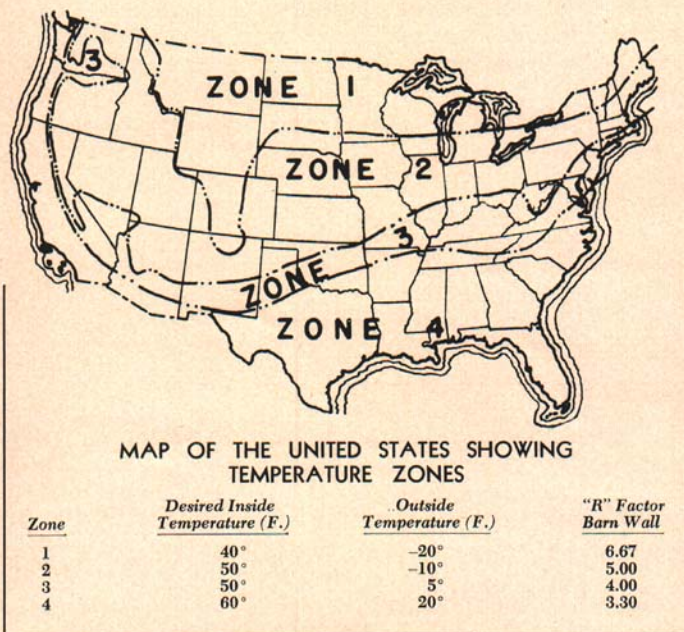

Fig. 2. Recommended resistance-values for dairy barn walls.

BARN CONSTRUCTION

Two things will affect the design of barns and ventilating system: Winter weather-conditions and the stable temperature in which the farmer prefers to work. Almost all dairymen prefer a working temperature higher than that actually required by cows. Drafts are harmful to dairy animals, but temperatures as low as 40°F. will not reduce milk production when the cows are exposed regularly to these lower temperatures.

Determining Insulating Requirements

Figures 2 and 3 will help you determine proper insulating requirements for your barn.

Figure 2 shows the resistance factor ("R") which should be built into a barn wall in the different temperature zones of the United States. "R" is the resistance of a wall to the passage of heat through the wall. Figure 3 gives the "R" rating of various types of wall construction and ceiling sections.

For average Michigan conditions an "R" rating or "factor" of 5.00 is recommended. Dairymen living in Northern Michigan should build a wall with an "R" factor somewhat higher. Figure 3 gives five wall-sections which have an "R" factor above 5.00. In the southern tiers of counties, a wall with an "R" rating approaching 5.00 usually proves satisfactory. Two such walls are shown.

Ceilings in the dairy stable must be insulated also. In most dairy barns the stable ceiling is the haymow floor. Several feet of hay or straw over the floor during the cold months of the winter provide the needed insulation. Where the ceiling of the dairy stable is not covered with hay or straw, insulating material must be added to the ceiling to give an "R" value of 5.00 or more—to prevent condensation of moisture on the ceiling (Fig. 3). Oftentimes, the outline of a haymow driveway is readily noticeable on the dairy stable ceiling, because of the excessive moisture condensing on the area not protected by hay or straw storage above.

MECHANICAL VENTILATION SYSTEMS

Advantages

1. A mechanical system is positive in operation.
2. It can be turned off and on automatically or by manual control.









WALL CONSTRUCTION		"R" Factor
	<i>3/4-inch drop siding, paper, studs, and 1-inch matched boards</i>	3.68
	<i>3/4-inch drop siding, studs, 1-inch insulating-board as interior finish</i>	4.15
	<i>3/4-inch drop siding, studs, 1-inch insulating-board sheathing as interior finish</i>	5.66
	<i>8-inch concrete, furring strips, 1-inch insulating-board sheathing</i>	5.36
	<i>8-inch stone walls (No interior finish)</i>	1.58
	<i>8-inch stone walls, furring strips, 1-inch insulating-board</i>	5.53
	<i>8-inch CONCRETE blocks, furring strips, 25/32-inch insulating-board interior finish</i> ..	5.06
	<i>8-inch CINDER blocks (No interior finish)</i> ...	2.44
	<i>8-inch CINDER blocks, furring strips, 25/32-inch insulating-board interior finish</i>	5.72
CEILING SECTIONS		"R" Factor
	<i>1-inch boards, joists, 3/4-inch insulating-board</i>	5.89
	<i>1-inch boards, joists, 1-inch shavings, paper, and 1-inch boards</i>	6.10

Fig. 3

3. It is simple and easy to install. The exhaust fan may be mounted in a window, or in a space left for it during construction. (See Figs. 4 and 5.)
4. The operating cost is low.

Disadvantages

1. Noisy fans have sometimes been used. Modern, slow-speed fans are practically noiseless.
2. A mechanical system cannot be used where electric power is not available.
3. Wherever moving parts are used, maintenance cost must be considered.

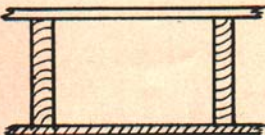
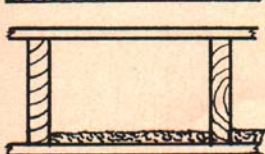
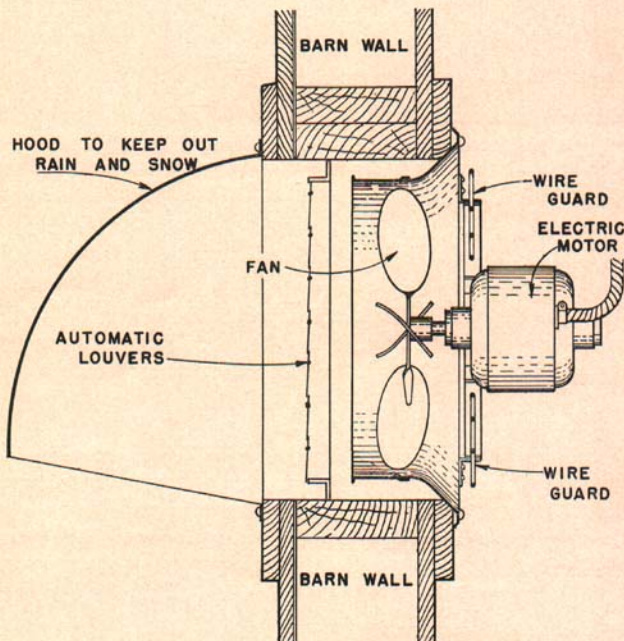

Fig. 4. Detail of a mechanical ventilating fan. The diagram shows how the hood on the outside of the barn protects the exhaust fan from snow and rain.

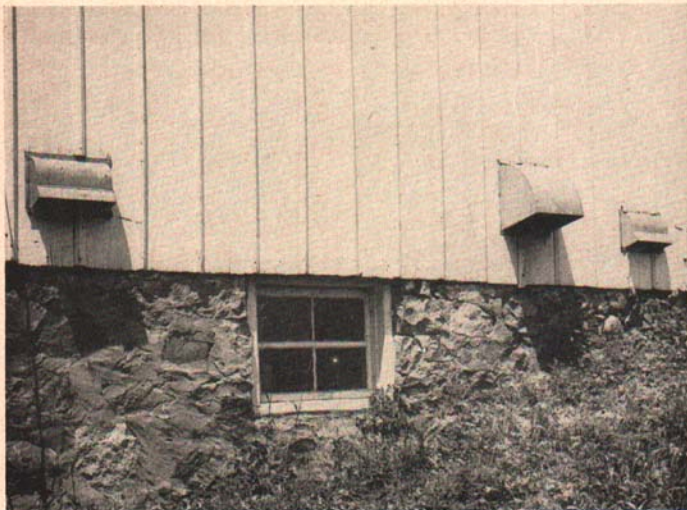

Fig. 5. Outside view of parts of a mechanical ventilating system. The smaller metal guards, at the extreme left and right, are for the automatic fresh air inlets. The larger hood protects the exhaust fan (see diagram in Fig. 4).

OPERATION

Rapid changes in weather conditions cause a varying demand on a ventilating system. During moderate weather—when the outside temperature approaches the temperature inside the stable—a large quantity of air must be moved to keep the barn from overheating. In cold weather, the air-flow must be reduced by intermittent fan operation, or by stopping one of a system of fans. This changing demand is met by a mechanical system equipped with an automatic control.

More uniform conditions can be maintained by automatic controls than can possibly be attained with any type of hand-operated system. Figure 6 shows typical installations in large and small barns. With mechanical systems, it is necessary to make the barn tight, provide fresh air inlets, and maintain 550 to 650 cubic feet of space per cow. Insulation is necessary for good results.

Location of Exhaust Fans

The exhaust fan should be placed on the side of the barn away from the direction of prevailing winds. Commercial installations are

equipped with shields and back draft devices to protect the fan from excessive wind resistance. (See Figs. 4 and 5.) Where one fan is used, it should be placed in the center of the long wall in order to maintain uniform conditions throughout the barn. If two or more fans are used, they should be placed according to the floor plan shown in Fig. 6.

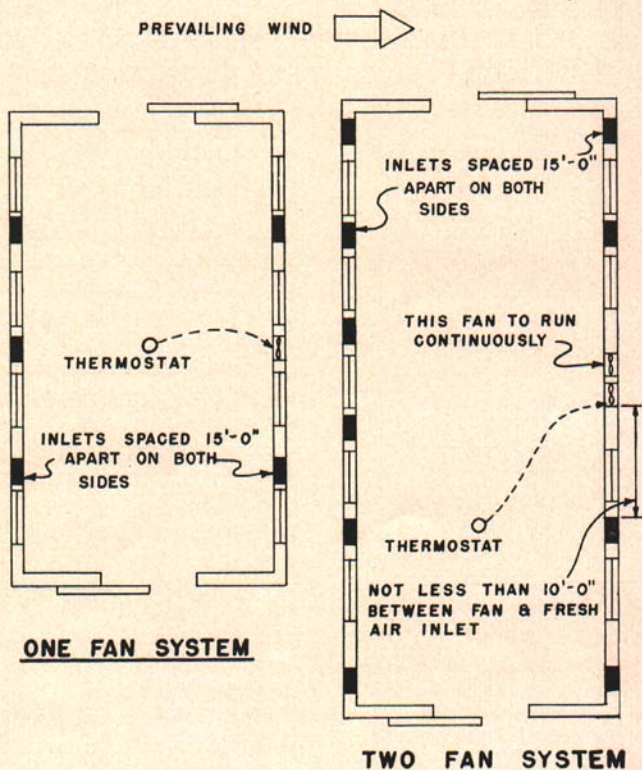

Fig. 6. Floor plans showing the one-fan ventilating system adequate for a small barn, and the two-fan system necessary in a larger barn. Note location of the controls in each system, and how the fans are paired for the large structure.

The Exhaust-Fan Flue

Figure 7 shows a satisfactory way of constructing an exhaust flue. Such a flue makes it possible to exhaust the air from near the floor of the stable, and thus conserve heat during cold weather. In mild weather, an upper door may be opened to permit warm air to be drawn off the ceiling, thus keeping the barn cooler. The cross-section area of the exhaust flue should equal or exceed the area of the fan opening (Fig. 8).

Fan-Types and Capacities to Use

There are two types of fans used for moving air. The *centrifugal* type of fan is designed for moving large volumes of air through a system of ducts. It is not as satisfactory for dairy-barn ventilation as the propeller type of fan. The *propeller* type varies in size, shape, and number of blades. A fan with fewer blades must be run at a higher speed, and is usually more noisy than one with more blades run at a slower speed.

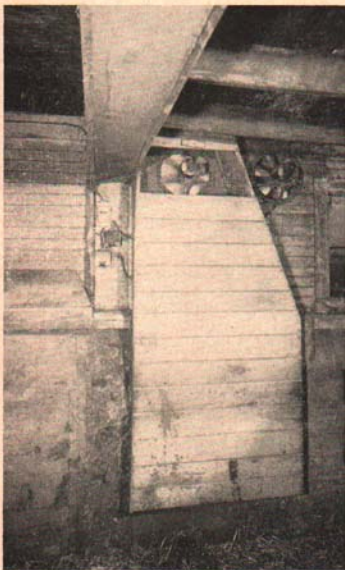

Fig. 7. Exhaust flue with removable upper door for mild weather operation. (See diagrams in Fig. 8.)

For the smaller herds, one fan will usually be sufficient. With a one-fan system, it seems advisable to exhaust 60 cfm. (cubic feet per minute) of air per cow. When two or more fans are used, a fan capacity of 80 cfm. per cow should be provided—with one fan operating continuously, and the remaining fans operating on a thermostat. Large volumes of air for cooling are not practical in most barns. The fan capacities required for herds of different sizes, based on those general recommendations, can be judged from Table 1.

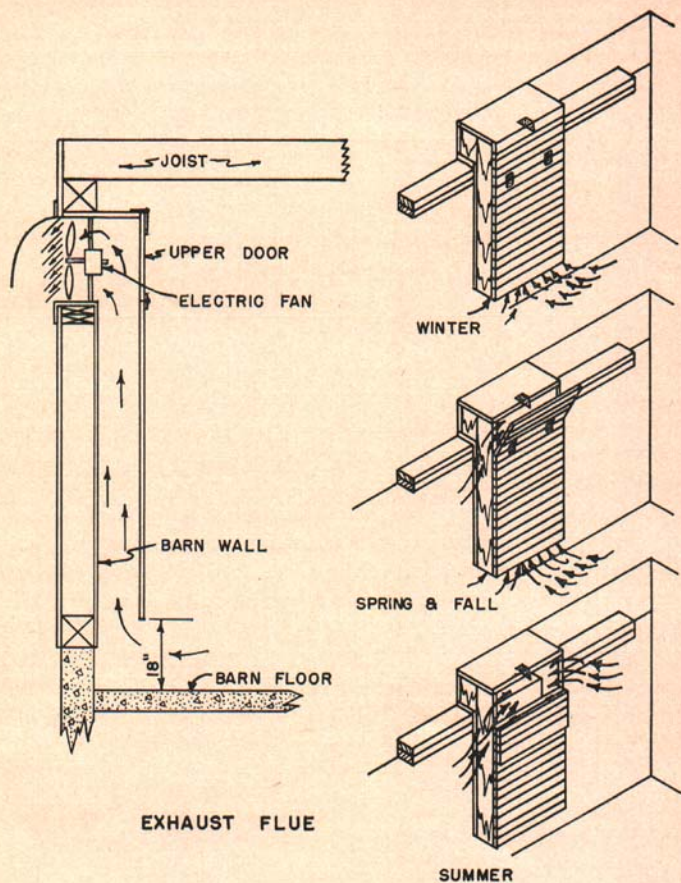

Fig. 8. Construction details of the type of exhaust flue shown in Fig. 7. Diagrams at the right illustrate how the door at the top of the fan duct is opened during mild weather, so that the fan draws the air off the ceiling; and closed when outside temperatures are low, so that the air is drawn from the barn floor.

TABLE 1—*Exhaust-fan capacities required for efficient mechanical ventilation of dairy barns.*

SIZE OF HERD	NUMBER OF FANS	INDIVIDUAL FAN CAPACITY (cubic feet per minute)
1-9 cows.....	1	540 cfm.
10-11 cows.....	1	660 cfm.
12-13 cows.....	1	780 cfm.
14-15 cows.....	1	900 cfm.
16-17 cows.....	1	1,020 cfm.
18-20 cows.....	1	1,200 cfm.
25 cows.....	2	1,000 cfm.
30 cows.....	2	1,200 cfm.

Automatic Controls

Temperature control is one of the primary purposes of a ventilating system. A thermostat is the most satisfactory type of automatic device with which to operate a mechanical system. (A "humidistat" might be used, but condensation will not be a problem if temperature is controlled.) Time-clocks are unsatisfactory because they will not respond to changing weather conditions. In Michigan some automatic device, preferably a thermostat, should be used to shut off all fans at a pre-determined low limit—so that the inside temperature of the barn will not go below 32°F.

The thermostat should be placed approximately 5 feet above floor level, and in the center of the barn (Fig. 6.) The exact position of the control will vary from one barn to another, depending on individual conditions. It is a good rule to place the control away from windows, doors, hay chutes, exhaust fan—or any place where cold air enters the barn.

FRESH-AIR INLETS

Purpose

In any barn which is built well enough to conserve heat in cold weather, it will be necessary to provide fresh-air inlets. They aid in the distribution of fresh air, removal of odors, and in maintaining a uniform temperature.

Size and Spacing

Fresh-air inlets should be spaced evenly along both sides of the barn, allowing 20 square inches of inlet-area for each cow. Figure 6 shows how one air inlet should be provided approximately every 15 feet, along *both sides* of the barn wall. The presence of a cold wall-area over pens where moisture condenses—or along the end of the stable—indicates a need for an extra inlet in that particular area.

The standard inlet is 60 square inches, and any shape is permissible. Inlets may be larger than 60 square inches, but should not be smaller.

Different Types

There are many types of fresh-air inlets, both commercial and home-made. (Figs. 9-14.) Figures 9, 10 and 12 show some of the

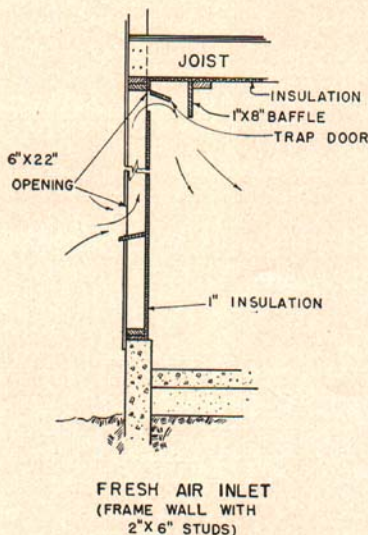

Fig. 9. Construction of a fresh air inlet for a frame wall barn with 2" x 6" studding.

possibilities for home-made inlets for above-ground walls; and Figure 11, for "bank" barns. These home-made inlets are satisfactory, but should be equipped with a device to prevent drafts and some positive means of throttling during cold windy weather. An outside hood or louver and a flue (such as shown in Fig. 9) will give draft protection. "Straight through" fresh-air inlets are not satisfactory.

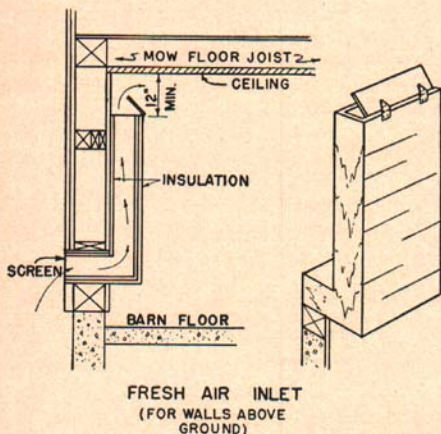

Fig. 10. Construction of a fresh air inlet for an old timber-frame barn, in the frame walls above the ground.

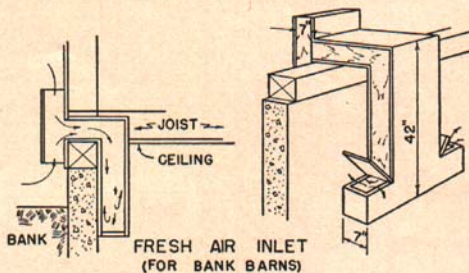

Fig. 11. Construction of a fresh air inlet for a "bank" barn with masonry walls.

Some very satisfactory mechanical systems have been built and installed by Michigan farm operators, at a minimum cost and with a

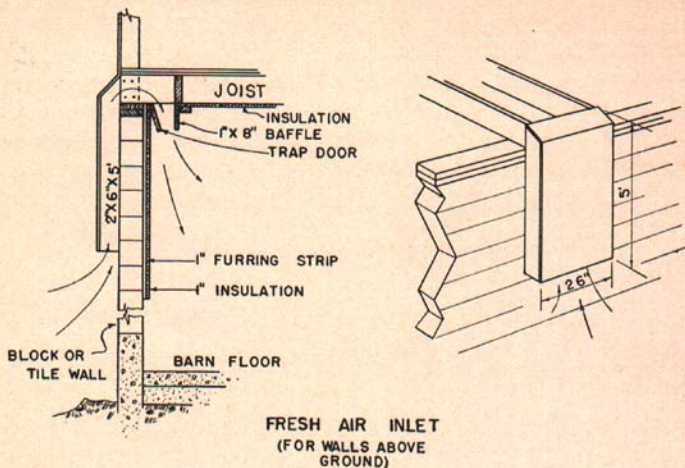

Fig. 12. Construction of a fresh air inlet from a barn with masonry walls above the ground.

high degree of operating efficiency. Figure 13 shows a timber-frame dairy barn which was equipped almost entirely by the owner himself, after proper planning. The interior detail in Fig. 13 indicates the relative simplicity of a well-built "home-made" system.

Figure 14 illustrates how another owner made provision during the construction of a new masonry-walled dairy barn for installation of mechanical ventilation at a later date. The inlets were planned for, and an 8" x 8" building block left out of the wall during building at each intended location. The wooden baffle-plates and sheet-metal ducts could then be added later on the inside.

In some barns, however, the inlets shown may be difficult to install. In such cases an inlet through the ceiling to the haymow can be made by drilling holes around the whole stable at the plate line; or by leaving a slot approximately an inch wide around the stable, except above the exhaust fan.

Commercial fresh-air inlets can also be used. These inlets reduce the velocity of the air entering the barn due to wind, and prevent back-drafts. A damper is provided to throttle the inlet during abnormally cold weather. These dampers should be operated manually once or twice a month to prevent them from freezing in one position.

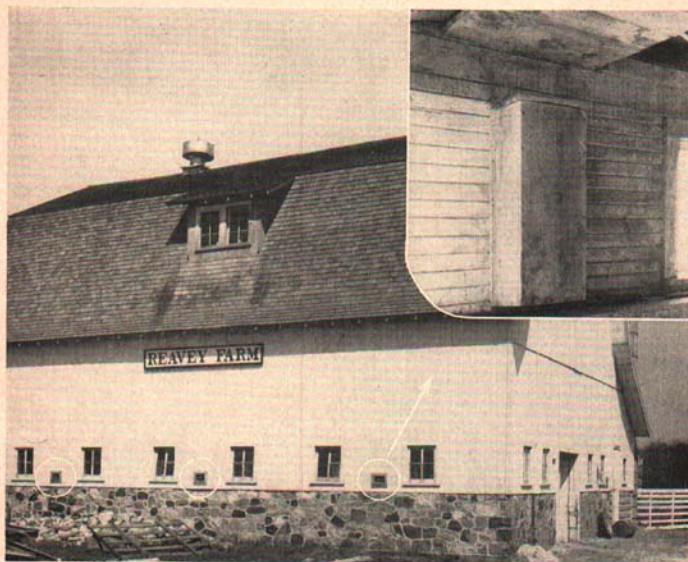

Fig. 13. An older, timber-frame dairy barn equipped for mechanical ventilation. The ventilating system was constructed by the owner. The fresh air inlets (circled in white) are shown along the outside wall, just above the stonework. An interior view of one of the inlets (inset, upper right) shows the board flue—and the flat baffle above it which deflects the fresh air away from the ceiling, back down along the walls. (Compare with the diagrams in Fig. 10.)

The space between the joists serves as a duct and mixing chamber. Baffle plates direct the air in any desired direction as it enters the stable.

NATURAL VENTILATING SYSTEMS

Advantages

1. There are no moving parts.
2. The system can be built at home.
3. There is no operating cost.

Disadvantages

1. A large, bulky flue utilizes needed space in the dairy stable, as well as in the mow.

2. The flue is expensive because of the cost of materials and labor necessary for its construction.
3. The flue, extending from the stable through the mow and above the highest point of the roof, presents a fire hazard.
4. The natural-draft system causes more air to be circulated through the barn when the need is less, and less circulation when the need is greater.

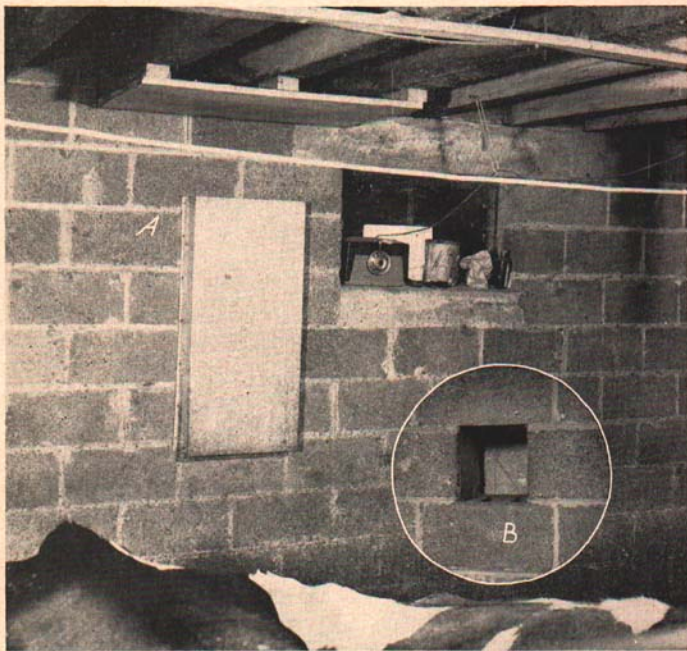

Fig. 14. Interior view of a fresh-air inlet in a modern dairy barn with masonry walls. The sheet-metal duct (A) carries the air upward against the wooden baffle spiked across the ceiling joists. The baffle then deflects the fresh air downward and outward, without placing the cattle in a draft. (For greatest efficiency, the duct should be covered with one-inch rigid insulating board.) An outside view (circular inset) shows how the builder planned for the inlet by leaving an 8" x 8" block (B) out of the wall during construction.

Theory of Operation

In any well-stocked barn the air is warmer—and therefore lighter—than the outside air. The heavier air outside presses against the

fresh-air inlets in the barn wall, with a greater force than the lighter air inside presses against these same inlets. Therefore, the outside air moves in.

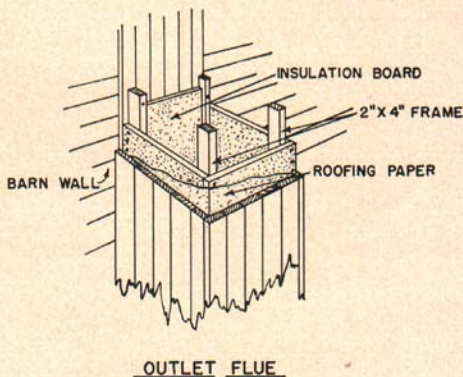

Fig. 15. Construction of an outlet flue for a natural-draft ventilating system. (For possible locations, see Fig. 16.)

Theory of Operation

This movement can continue only if the stale, light, air inside has an opportunity to escape. An outlet flue—built to extend from near-the-floor in the stable to a point several feet above the ridge of the roof—conducts the stale, moisture-laden warm air out of the barn. This air is actually pushed out of the barn by the pressure of the fresh air coming in. (The system works on the same principle as a chimney flue. Of course, the air in a heated chimney is hotter and much lighter than the air in a ventilation flue and is pushed up the chimney by the cold, heavy air much more rapidly. Hence the movement of air in a ventilating system is much slower than in a heated chimney.)

To ventilate any dairy barn properly by natural means, it is necessary to maintain from 550 to 650 cubic feet of space per cow; stop all cracks; insulate to conserve heat; provide fresh-air inlets; and construct an outlet flue. Construction of a suitable outlet flue is shown in Fig. 15. The size of the outlet flue depends on the number of animals housed; the air space per animal; and the difference in elevation from the stable floor to the roof. (See Table 2, page 24.)

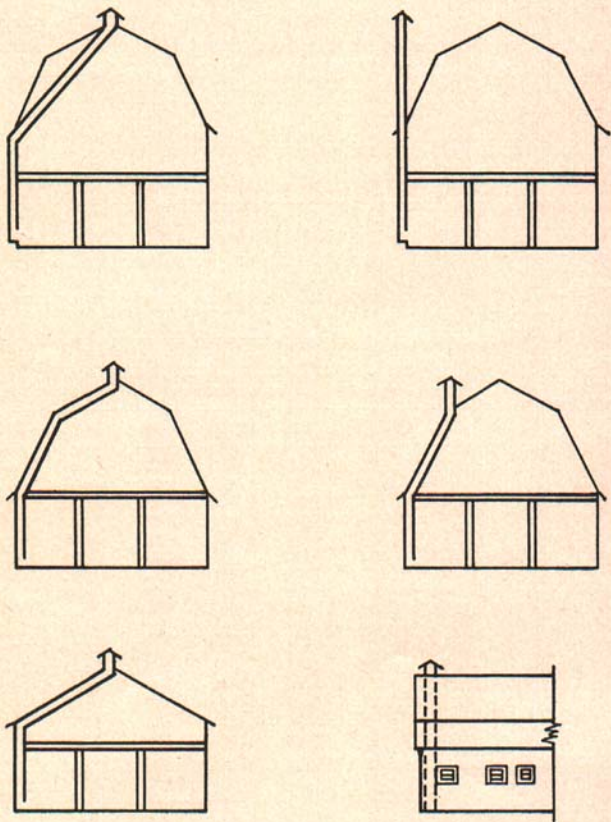

Fig. 16. The size of the barn and the type of construction will usually determine the location of the foul-air flue in natural-draft ventilating systems. Some of the better locations for outlet flues are indicated in these diagrams.

THE OUTLET FLUE

Construction

The flue can be built of insulating board, and covered with matched lumber (Fig. 15). It should be air-tight, and insulated to prevent cold air from entering the flue to stop the upward flow of stale air.

Location

The flue should be located where it will not interfere with the daily chores. It may be located inside or outside the barn wall, and at one end. In a long or irregularly shaped barn, it is advisable to place the flue near the center—or to use two flues. Various locations for the outlet flue of a natural ventilating system are illustrated in Fig. 16.

TABLE 2—Outlet-flue areas required for natural ventilating systems in dairy barns.

NUMBER OF ANIMALS IN THE HERD	TOTAL FLUE-AREA IN SQUARE INCHES (according to height of barn from stable floor to ridge of roof)						
	20 ft.	25 ft.	30 ft.	35 ft.	40 ft.	45 ft.	50 ft.
8	400	400	400	400	400	400	400
10	455	400	400	400	400	400	400
12	544	474	422	400	400	400	400
14	636	553	493	448	415	400	400
16	727	632	563	512	474	445	420
18	819	710	635	577	534	500	472
20	910	790	704	640	594	556	525
22	995	870	774	705	652	610	577
24	1080	950	845	769	711	667	630
26	1165	1025	915	834	770	724	683
28	1245	1100	985	900	830	777	735
30	1330	1165	1055	964	890	835	788
36	1570	1370	1235	1140	1050	1000	945
42	1805	1585	1430	1310	1215	1145	1095
48	2028	1780	1605	1470	1370	1290	1290
54	2242	1975	1780	1630	1515	1430	1363

FRESH-AIR INLETS

For fresh-air inlets in a natural ventilating system, see the discussion of inlets for mechanical ventilating systems on pages 15-20. The same principles of construction, size and spacing apply for either type of system.