

EXTENSION BULLETIN 289

FILE COPY
DO NOT REMOVE



HANDMADE RUGS

Toothbrush Handle Rugs
Safety Pin Rugs



MICHIGAN STATE COLLEGE
EXTENSION SERVICE
EAST LANSING

Issued February 1948

Handmade Rugs

Toothbrush Handle Rugs—Safety Pin Rugs

By RUTH J. PECK and JESSIE MARION

Extension Specialists in Home Furnishings

Making rugs is a practical way of using old clothing and scraps of materials. It is one way of providing a floor covering of the correct size and of the correct colors with little cash outlay.

A handmade rug should be worth the time and effort put into it. More time is required to collect, sort and prepare the materials than actually to construct the rug. A definite plan for the entire rug must be made before the work is started.

THE RUG MUST LIE FLAT

A handmade rug must be heavy enough to lie flat on the floor. The stitches and rows must be close and tight so that the rug will be very firm and so that there will be no open places in it.

The way the colors are distributed influence the appearance of flatness. The rug will appear flatter if colors that **blend** are used rather than colors that are in strong contrast to each other. It is better to use medium-to-dark tones rather than bright ones. The colors in the rug should repeat the colors in the room in which the rug will be used.

PLAN SIZE AND SHAPE

Rugs should be made to fit the place in which they are to be used. The size of the place determines the size and shape of the rug. Large rugs should be made to use with large pieces of furniture. A well-proportioned oval or rectangle is usually the most appropriate shape for a rug.

A rug is pleasing in shape if the width is slightly less than two-thirds of the length. Some examples of good dimensions are:

- 24 inches wide by 40 inches long.
- 27 inches wide by 45 inches long.
- 30 inches wide by 49 inches long.

In planning an oval rug the **length** of the **center braid** determines the length and width of the finished rug. In order to estimate the length for the center braid, first determine the size of the finished rug. Then subtract the width of the rug from the length of the rug for the approximate length of the center braid. It is well to add 3 or 4 inches to this estimated length, as the original braid will become shorter when the adjoining rows are attached to it.

For example: for a rug 27 inches by 45 inches,

45 inches — 27 inches = 18 inches, the estimated length.

18 inches + 4 inches (allowance) = 22 inches, length to
make center braid.

LIMIT THE NUMBER OF COLORS

A color scheme of two or three colors, or several tones of one color, is easier to achieve than one of many colors. If both warm and cool colors are used in a rug a larger amount of one type should be used. There should be a predominance of medium or dark tones when several tones of one color are used as the basis for the color scheme. A good proportion for a three-color scheme is 50 percent of the dominant color, 35 percent of another, and 15 percent of a third.

The colors selected for a rug will blend better if soft greyed colors are used. The tones may vary from medium light to dark. Sometimes small amounts of a slightly brighter tone are distributed throughout the various parts of the rug to give sparkle. Colors that are in strong contrast to each other should be avoided.

COLLECT ENOUGH MATERIAL

It takes a long time to collect enough material of the right weight and of suitable colors to make a rug. Select materials which will stand the hard wear to which rugs are subjected.

A guide to the amount of material required is:

3 square yards of material weigh about 1 pound,

1 pound of medium-weight wool makes about 1 square foot.

It is advisable to use only one kind of material in a rug. Do not mix cotton and wool or cotton and rayon, as the wearing quality differs with each type of material. Use only the good parts from old garments. Any necessary cleaning and dyeing should be done before the material is cut into strips.

DIRECTIONS FOR THE TOOTHBRUSH HANDLE RUG

The toothbrush handle rug makes an oval rug suitable for the living room, dining room or bedroom. It is very firm and is heavy enough to lie flat on the floor.

The materials used in this type of rug can be lighter in weight than those for the safety pin rug. Cotton materials that work up nicely can be obtained from dress and apron prints, shirts and feed sacks. Woolen material must be light in weight, otherwise the rug is too thick and bulky.

An oval rug 31 inches by 43 inches made by this method, required 26 yards of new cotton print. Of this amount 14 yards were plain brown and 12 yards were prints. This would be equivalent to about 13 house dresses and smocks.

PLAN THE COLORS

The color scheme for a rug must be carefully planned before the rug is started. The all-over or hit-and-miss color scheme is best for this type of rug. Even this must have a plan if the rug is to harmonize with the other furnishings in the room and if it is to appear flat.

Some suggestions for proportioning color are:

	<i>Warm Color Scheme</i>	<i>Cool Color Scheme</i>
50 percent	Brown	Dark blue
35 percent	Green	Wine
15 percent	Greyed red-orange	Medium blue

The dominant color need not be the darkest color. In order to distribute the dominant color throughout all parts of the rug, insert a strand of this color at frequent intervals. At first the strand may be long enough to make only four or five stitches. As the rug gets larger, the strand may be longer and the last few rows of the rug may be entirely of this background color (Fig. 1).

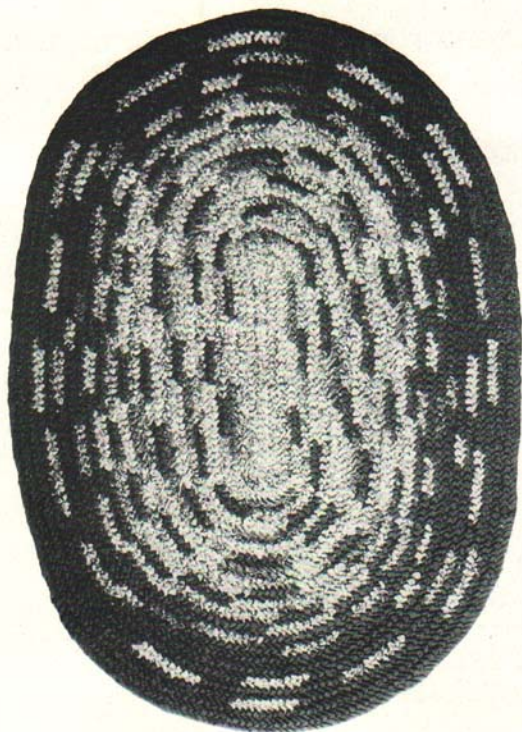

Fig. 1. Distribute the dominant color throughout all parts of the rug by inserting a strand having this color at frequent intervals. The strand, at first, may be long enough to make only four or five stitches. As the rug gets larger the strand can be longer. The last few rows of the rug may be entirely of the dominant color.

In a similar way the small amounts of a slightly brighter color may be introduced; however, the number of stitches made with this color would always be small. This color would never be used for the outside row or rows of the rug.

It is impossible to avoid the jog in the rows when there is a definite color change. The use of the all-over or hit-and-miss plan makes the changing of colors a definite part of the plan.

PREPARE THE MATERIAL

Use material of similar weight or cut the strips of the different materials in varying widths. The strips when folded should be about the same thickness. Check on the width for the strips by making a small sample before cutting all of the material.

Cotton material may be cut or torn lengthwise. Woolen materials must always be cut. Some cottons and woolens can be cut crosswise of the grain.

Cutting the Strips

For the weaver:

Cut print dresses, aprons, feed sacks, shirts, etc., 1½ inches wide.

Cut worn overalls, cotton draperies, lightweight woolens, 1¼ inches wide.

For the braid:

Cut three strips 2 inches wide. The length will be determined from the measurements for the center braid. (See "Plan Size and Shape," page 3.)

Joining the Strips

Short strips may be sewed together to make strips from 1 to 2 yards long. This length is a convenient one with which to work. Always join the strips on a true bias.

Place the right sides of the two strips together at right angles, letting the ends extend $\frac{1}{4}$ inch. Sew across the corner where the dotted line shows in Fig. 2. Cut the corners off as indicated in Fig. 2. Press the seam open (Fig. 3).

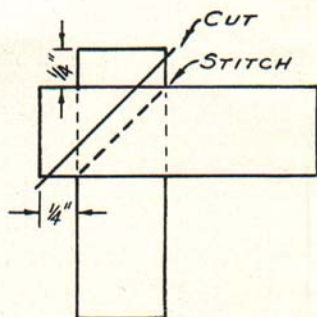

Fig. 2.

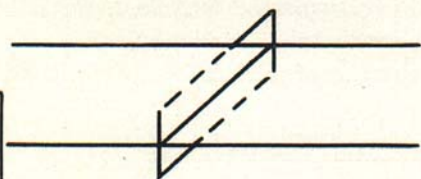

Fig. 3.

Folding and Stitching the Strips

Fold in the raw edges of the strip to meet in the center (Fig. 4) and press. Fold strip in half, lengthwise, with the raw edges inside (Fig. 5) and press. Slip stitch or machine stitch close to the open edge with matching thread. Use a long machine stitch (Fig. 6). Leave 3 inches unstitched at each end of the strips. This makes the joining of additional strips easier.

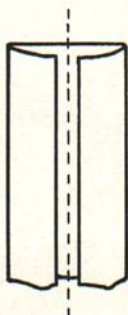

Fig. 4.



Fig. 5.

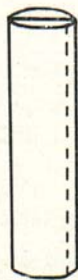

Fig. 6.

Winding the Strips into Flat Rolls

Wind the prepared strips into flat rolls such as tape is rolled. Insert a pin into the roll occasionally while winding. This will keep the roll firm and the strips in place. Do not mix colors in a single roll. Keep the rolls of one color together. Store until ready to make the rug.

The preparation of the strips takes more time than the actual construction of the rug. Check the amounts of the various colors to see that there is enough of each to carry out the color plan for the rug.

MAKE THE NEEDLE

The handle of a small or medium-sized toothbrush is used as a needle. Break off and discard the brush part (Fig. 7). To form the eye of the needle, enlarge the hole in the handle slightly with a small rat-tail file or a sharp knife blade. File the other end of the handle to a slender point, using a one-inch file or coarse sandpaper (Fig. 8).

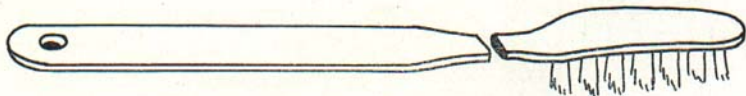

Fig. 7.

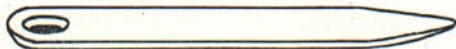

Fig. 8.

MAKE THE RUG

First Step

Make the center braid from three strands of the 2-inch width strips which have been prepared.

1. Place the three strips, one on top of the other, and whip the ends together firmly with a shallow stitch.

2. Make a fairly firm braid, folding the outer strands forward to make a smooth edge.

3. Test the braid by inserting the needle through the loops along the edge of the braid. The needle should go through the braid but not too easily.

4. Make the braid the desired length (length of rug minus width of rug plus 4 inches).

5. End the braid by overlapping the three strips, placing the end of a weaver on top and stitching the four strips together very firmly. The end of the braid must be as firm as the rest of it.

Second Step

1. Hold the end of the braid to which the weaver is attached in a horizontal position, between the thumb and index finger of the left hand. Let the braid extend to the right (Fig. 9).

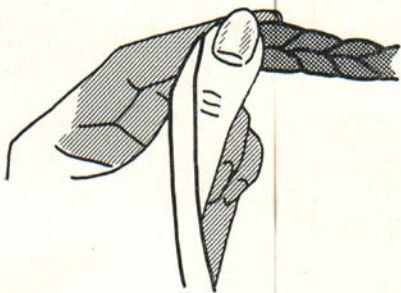

Fig. 9.

2. Bring the weaver from back of the thumb and let it drop down across the front of the thumb (Fig. 9).

3. Insert the needle through the first loop on the top edge of the braid. Always point the needle upward and to the left (Fig. 10).

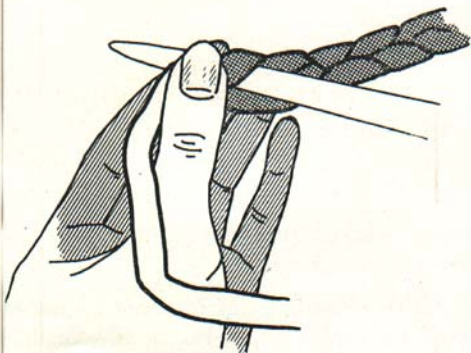

Fig. 10.

4. Draw the needle through until the weaver forms a loose loop around the thumb (Fig. 11).

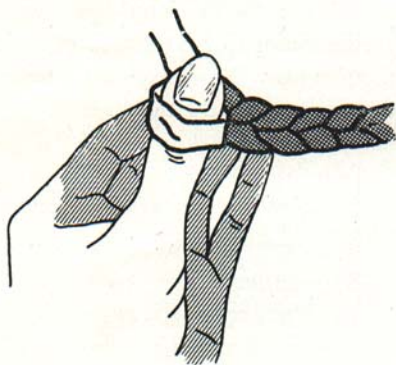

Fig. 11.

Third Step

1. Bring the weaver around the thumb, from the left.

2. Insert the needle through the same (first) loop of the braid and twist the thumb-loop to form a "figure-8" around the point of the needle. (This is similar to casting on stitches when knitting.) There are now two loops on the needle (Fig. 12).

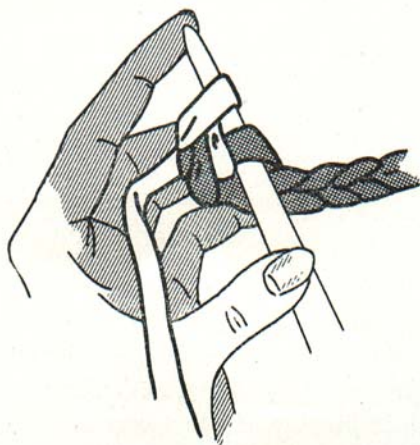

Fig. 12.

3. Hold the two loops between the thumb and fingers, and draw needle through until the weaver forms a fairly loose loop around the thumb. Keep the weaver flat. *Note:* There is now one loop around the weaver back of the thumb.

Fourth Step

1. Bring the weaver down across the thumb from the left.
2. Insert the point of the needle through:
 - the second loop on the top of the braid,
 - the loop on the weaver back of the thumb,
 - the thumb-loop twisted over the point of the needle to form a figure-8.

There are now **three** loops on the needle (Fig. 13).

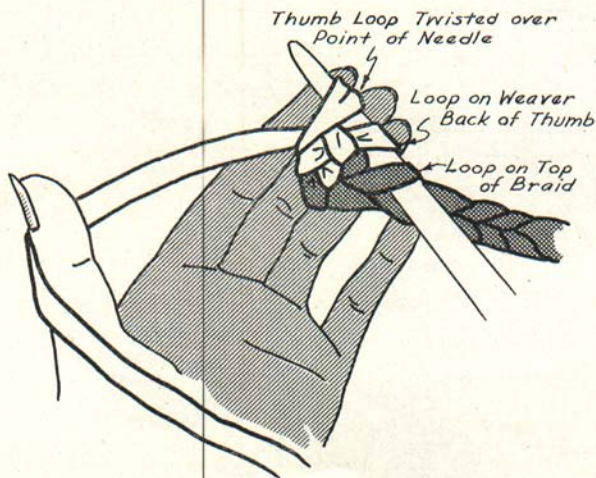

Fig. 13.

3. Hold the three loops between the thumb and fingers. Draw the needle through until the weaver forms a fairly loose loop around the thumb. *Note:* There are now **two** loops on the weaver back of the thumb.

Fifth Step

1. Bring the weaver down across the thumb, from the left.
2. Insert the point of the needle through:
 - the third loop in the braid,
 - the left or top loop on the weaver back of the thumb,
 - the thumb-loop twisted over the point of the needle.

There will always be **three** loops on the needle at this point.

3. Hold the three loops between the thumb and fingers, and draw the needle through until the weaver forms a fairly loose loop around the thumb.

Repeat the fifth step, taking a stitch in every loop along the top of the braid, until you come to the last two loops on this side of the braid.

Put two stitches into each of the last two loops in the top of the braid, keeping the thumb-loop much looser than it has been.

Turn the braid around and continue down the other edge of the braid.

Put two stitches in the first and second loops on this edge of the braid. Always point the needle upward and to the left.

Put one stitch in each loop along the braid until you come to the last two loops of the braid.

Put two stitches in each of these last two loops in the braid, leaving the thumb-loop looser.

The stitches from here on will be in the loops along the edge of the rug. There is a ridge on the side of the rug away from you.

Precautions

1. Keep the weaver flat at all times. See that the weaver is straight before taking a stitch. Twist the needle one turn to the right as it is drawn through the loop in the rug.

2. Keep the thumb-loop fairly loose. Keep it very loose on the curves.
3. Prevent the rug from cupping by:
 - adding extra stitches at the curves and along the sides, as needed,
 - pressing and shaping the rug on a flat surface from time to time.
4. When you stop work, pull the thumb-loop up to form a large loop or leave the three loops on the needle. This insures a correct start when you resume your work.

When the rug is as large as you want it to be, plan to stop on the curve, just after you have gone around the end of the rug. To make a tapered finish do not pick up the loop on the weaver back of the thumb—insert the needle through the loop in the rug, then twist the thumb-loop over the point of the needle.

Make one or two stitches, using only the two loops on the needle.

Make one or two blanket stitches with the weaver.

Cut off the weaver, allowing a short end to tuck under the next loop in the rug.

Fasten the end securely with needle and thread.

Cover the rug with a damp cloth and press with an iron.

ALTERNATE METHOD

If the material is too heavy, the toothbrush handle rug may be made by using two loops on the needle instead of the three loops:

1. Bring the weaver down across the thumb from the left.
2. Insert the needle through:
 - the loop along the top of the braid,
 - the thumb-loop twisted over the point of the needle.
3. Hold the two loops between the thumb and fingers, and draw the needle through until the weaver forms a fairly loose loop around the thumb.

DIRECTIONS FOR THE SAFETY PIN RUG

The safety pin rug is a four- or six-strand braided rug which is oval in shape. The braid is laced into the rug as the weaving is done, thus eliminating the sewing of the braids.

If made of light or medium weight woolens, this type of rug is suitable for the living room. From cotton prints, draperies, and worn overalls, one can make a rug suitable for the bedroom, dining room or living room. Heavy coats, snow suits and blankets should not be used for this type of rug.

PLAN THE SIZE, SHAPE AND COLORS

The proportions for a color scheme given under the toothbrush handle rug may be used for this type of rug. The all-over pattern is suggested for this rug also.

To be sure there is color harmony throughout the entire rug, it is wise to carry one color—the tones of which may vary—as one strand of every braid. It is better to make a change of color along a downward curve rather than on the side. Do not make a sharp color change of more than one strand at a time.

PREPARE THE MATERIAL

Use materials of similar weight or cut the strips of the different materials in varying widths. Check on the width for the strips by making a small sample before cutting all of the material.

Cutting the Strips

Cut cotton prints, such as aprons, dresses and shirts about 3 inches wide. Cut cotton draperies and old overalls $1\frac{1}{2}$ to 2 inches wide. Cut lightweight wool materials $1\frac{3}{4}$ inches wide.

Joining, Folding and Stitching the Strips

Join the strips on the true bias. Follow the directions and see Figs 2 and 3 on page 8.

Thin materials that must be cut 3 inches wide are folded in half lengthwise before the edges are turned in to meet at the center.

Materials that need to be cut 2 inches wide can have the edges overlap in the center.

The strips when folded and stitched should be from $\frac{1}{2}$ to $\frac{3}{8}$ inch wide and not more than 2 yards in length.

MAKE THE RUG

Four or six strands may be braided for this rug. It is well for the beginner to start with a four-strand braid.

First Step

1. Select four strands, one or two of which are the dominant color to be used in the rug. Have each strand a different length, the longest not more than 2 yards long.

2. Place the strands, one on top of the other, and whip the ends together very firmly with a shallow stitch.

3. Add new strands as needed, joining them on a true bias. Make the joinings at different places.

4. Use a large safety pin to fasten the stitched ends of the strand to a basting brick. Have the strands coming toward you.

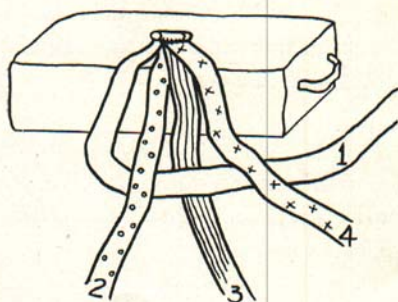

Fig. 14.

5. Spread the strands out fan-shape with the top strand to the right and the lower strand to the left. The left strand becomes No. 1, or the weaver (Fig. 14).

6. Start the weaving with the left strand or No. 1. Weave **under** No. 2 over No. 3, and under No. 4, and put the weaver out to the right (Fig. 14). Pull the

weaver firmly against the stitched end.

Second Step

1. The left-hand strand is now the new weaver. Weave this strand under the next strand, over the next, then fold the last strand forward over the weaver. Pull the weaver firmly into place and put it out to the right.

2. Proceed in this manner, always starting with the left-hand strand as the weaver. Weave under, over, under and pull the weaver out to the right.

3. Make this center braid a little longer than the estimated length for the center of the rug. (See "Plan Size and Shape," page 3.)

4. Remove the braid from the basting brick and fasten a medium small safety pin in the end of each strand as an aid to lacing.

Third Step

1. Take the left-hand strand and weave as before, under, over, under. Now insert the safety pin down through the first loop on the right-hand side of the braid and draw the weaver through (Fig. 15). Draw each strand firmly into place.

2. Turn the center braid into a horizontal position with the strands at the left. Weave as before — take the left-hand weaver and go under, over and under the strand that was put down through the first loop on the right-hand side of the braid. Now insert this weaver down through the same (first) loop of the braid. Place the rug on the table and pull each strand firmly into place.

3. Hold the braid so that the strands are coming toward you. From here on, as the weaving is done the weaver will be laced into the loops on the left-hand side of the rug.

Braid as before — take the left-hand weaver and go under, over, and under and insert from the top down through the second loop of the center braid. Weave again and put another stitch in the same (second) loop.

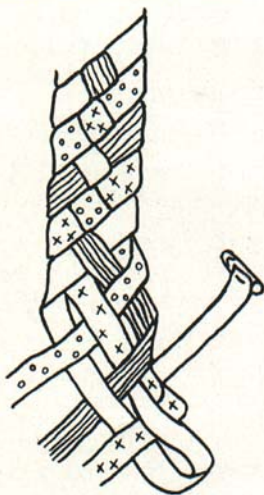

Fig. 15.

Note: Two stitches are put into each of the first two loops to give the required fullness on the curve.

4. Continue weaving from the left under, over, under, and go down through the braid from the top. Put only one stitch in each loop as you proceed down the edge of the original braid until the last two loops are reached.

Fourth Step

1. Put two stitches in each of the last two loops of the braid.
2. Weave again and slide the safety pin across the braid, under the center loop at the end of the braid.
3. Turn the rug around and weave from the left under, over, under and down through the first loop in the original braid.

Weave and put a second stitch in this same loop.

4. Put two stitches in the second loop of the original braid.

Fifth Step

Continue the weaving and lacing. Put one stitch through each loop along the left-hand side of the rug. Extra stitches will be needed at various intervals, especially around the end, in order to give the proper fullness and to make the rug lie flat.

FINISH THE RUG

Plan to finish the rug on a downward curve.

1. Weave and lace a strand through a loop in the rug. Cut this weaver, tuck the end under the braid and sew securely.
2. Take the next weaver and weave under, over, and then insert the safety pin into the loop from the **underneath** side. Cut this weaver and sew securely to the braid. There are now two strands left.
3. Weave under the remaining strand and insert into the loop from the top down. Cut the weaver, tuck the end in and sew securely to the braid.
4. Lace the last strand into the next loop, cut off, and sew securely. This makes a smooth, tapered finish.
5. Cover the rug with a damp cloth and press.

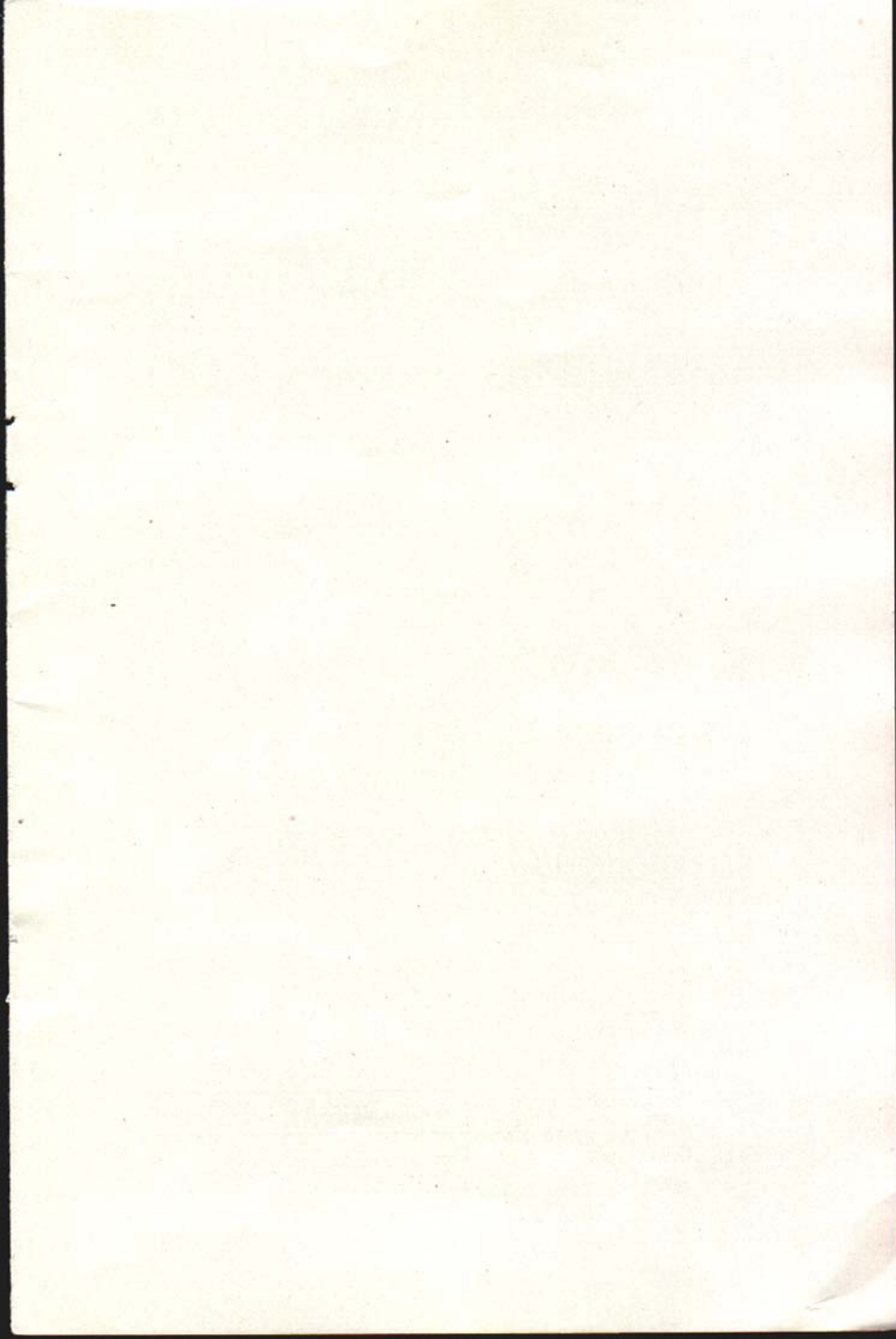



SERVING MICHIGAN

WKAR (870) - WKAR - FM (90.5)

Cooperative Extension Work in Agriculture and Home Economics. Michigan State College and U. S. Department of Agriculture cooperating. R. J. BALDWIN, DIRECTOR EXTENSION SERVICE, Michigan State College, East Lansing. Printed and distributed under acts of Congress, May 8 and June 30, 1914.

2:48-20M