



BRAIDED RUGS

CHARLOTTE BRENNAN ROBINSON

CORNELL BULLETIN
FOR HOMEMAKERS

Reprinted without change with the permission of the New York State College of Home Economics, Cornell University, Ithaca, N. Y. (Cornell Extension Bulletin 462, June 1941)

MICHIGAN STATE COLLEGE: EXTENSION SERVICE
EAST LANSING

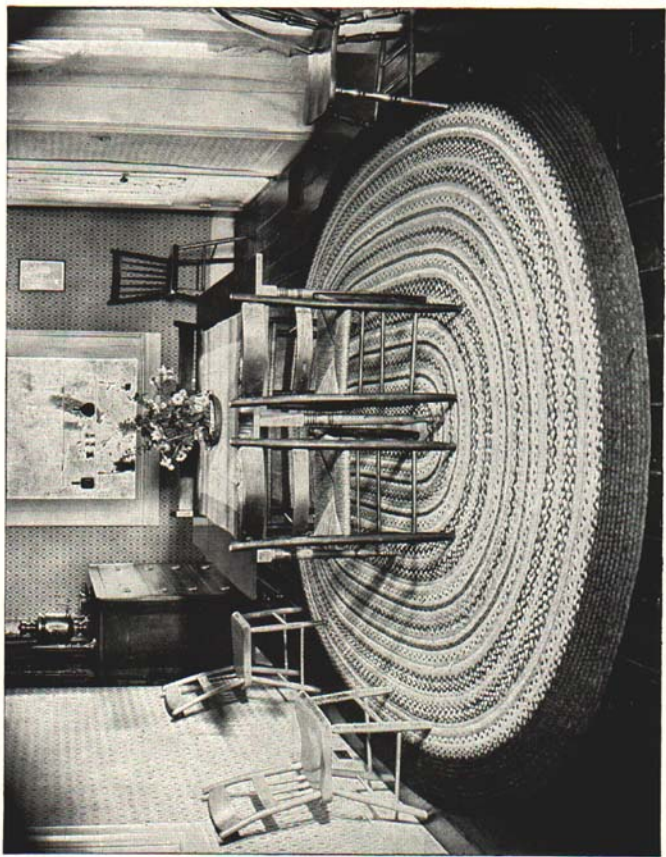

CONTENTS

	PAGE
Colors for the braided rug	5
Source of color scheme	5
Number and proportion of colors	5
The rug must look flat	5
Selecting the fabrics	8
Suitable materials	8
Color variety	9
Color fastness	9
Amount of material	9
Suitable used materials	9
Purchased materials	10
Equipment	10
Preparing the fabrics	11
Making the strips	11
Cutting	11
Folding	11
Rolling	12
Making the braid	13
Size	13
Beginning the braid	13
Sample braids	14
An oval all-over pattern rug	14
Planning size and shape	15
Making the paper pattern	15
Determining the length of center braid	15
Making the braid plan	16
Number of rows of braids needed	16
Arrangement of braids	16
Selecting the braids	16
Sewing the braids together	16
Adding new strips to braid	18
Changing the color	18
Finishing the rug	18
Ending the braid	18
Pressing the rug	19
A round rug	19
A striped oval rug	19
The color scheme	19
Making the rug	20
Braiding	20
Sewing the braid	20
Ending the braid	21
Simple method	21
Complex method	21

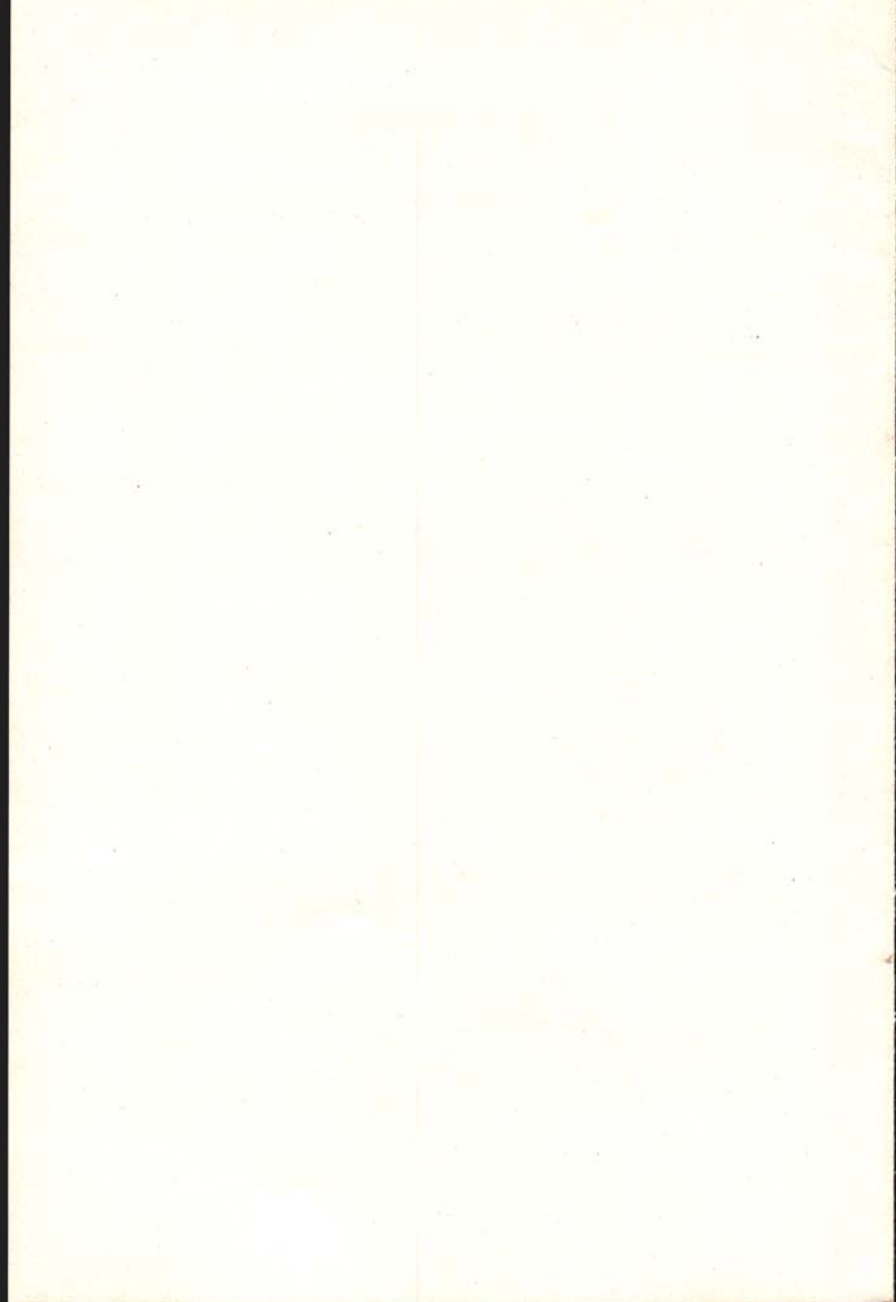

Braided Rugs

CHARLOTTE BRENNAN ROBINSON

THE BEST braided rugs are soft underfoot but heavy enough to lie flat on the floor without rumpling when stepped upon; they have close, strong braids and tight stitches that do not leave open places to catch toes, heels, and furniture legs and cause bad falls; they have colors that repeat and harmonize with those already in the room; and they are made of materials that will stand hard wear. These qualities may be had with little or no cash outlay.

Colors for the Braided Rug

Source of Color Scheme

The colors for the rug are selected from those in the large areas in the room in which the rug will be used. These are in the walls, draperies, floors, rugs, and upholstered and wood furniture. The rug should repeat one or more of these important colors if it is to look well in the room.

Number and Proportion of Colors

One color alone may be used, but two or more make the rug more interesting. With several colors, a large amount of one and smaller amounts of the others are best. A color scheme of two or three colors is easier to handle than is one of many colors. Good proportions are: for two-color schemes, 60 per cent of the dominating color and 40 per cent of the second one; for a three-color scheme, 50 per cent of the dominating color, 35 per cent of another, and 15 per cent of the third.

The Rug Must Look Flat

A braided rug should not only lie flat but should look flat. The way the colors are put together influences this appearance of flatness. Bright colors only or all dull, all pale, or all dark do this. Bright-colored rows of braids alternated with dull-colored ones produce a circular, striped effect that usually is not pleasing in a room, and may give the rug a wavy appearance. The same undesirable effect results from alternating very light-colored and very dark-colored groups of braids. Sometimes, however, a color lighter or darker, brighter or duller, than the majority in the rug may be used if only one strand at a time is worked into a braid. In this way a sparkle may be produced throughout the rug or in selected areas (figures 1, 2, 3, 4, and 5).

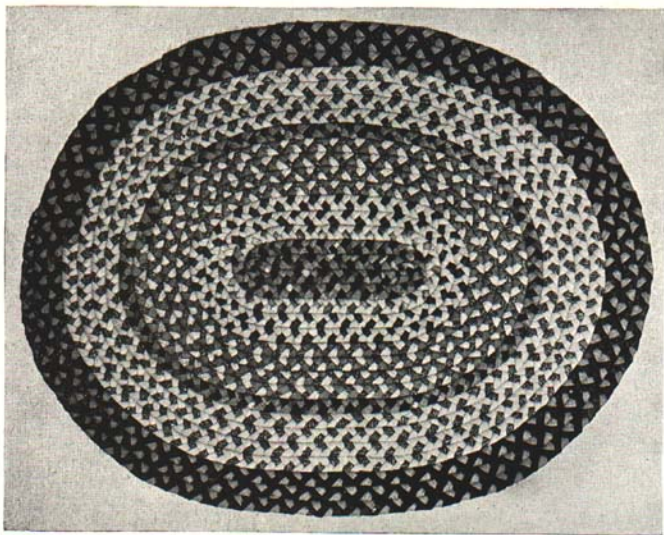

FIGURE 1. AN ALL-OVER PATTERN RUG WITH A DARK CENTER AND A DARK EDGE
The color scheme is rose, blue, and brown. Brown shading to tan is the color carried in one or two strands throughout the rug

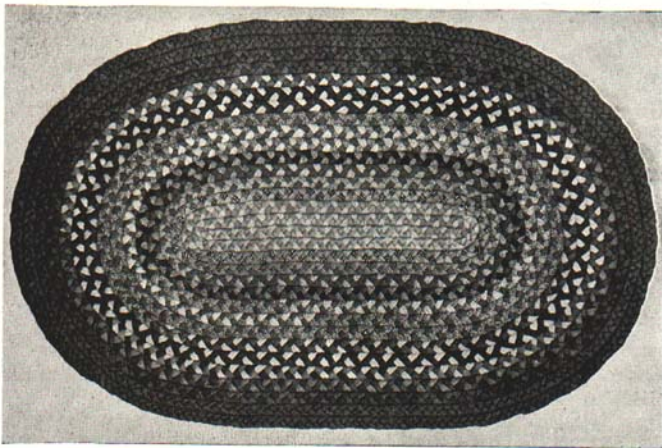

FIGURE 2. AN ALL-OVER PATTERN RUG WITH A LIGHT CENTER AND A DARK EDGE
The color scheme is tan, yellow, and blue. Tan shading to brown is the color carried in one or two strands throughout the rug

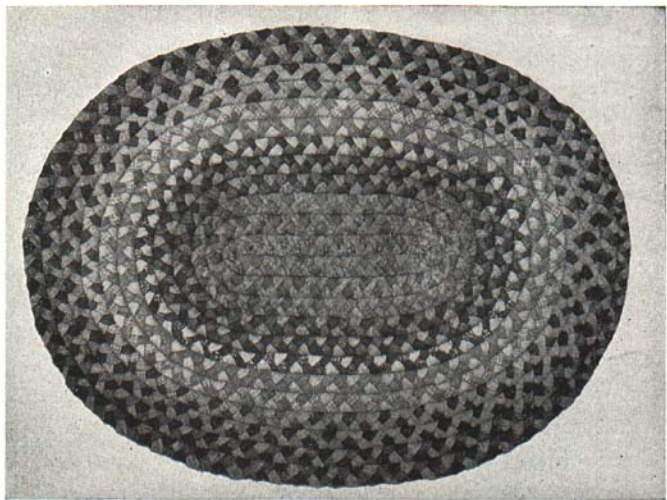

FIGURE 3. AN ALL-OVER PATTERN RUG WITH A MEDIUM-COLORED CENTER AND A DARKER EDGE

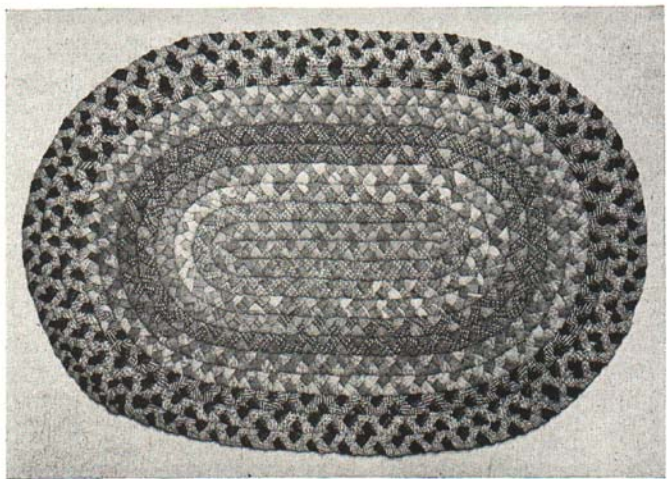

FIGURE 4. AN ALL-OVER PATTERN RUG WITH THE EDGE DARKER THAN THE CENTER
The color scheme is tan, green, and rose. Tan shading to brown is carried in one or two strands throughout the rug

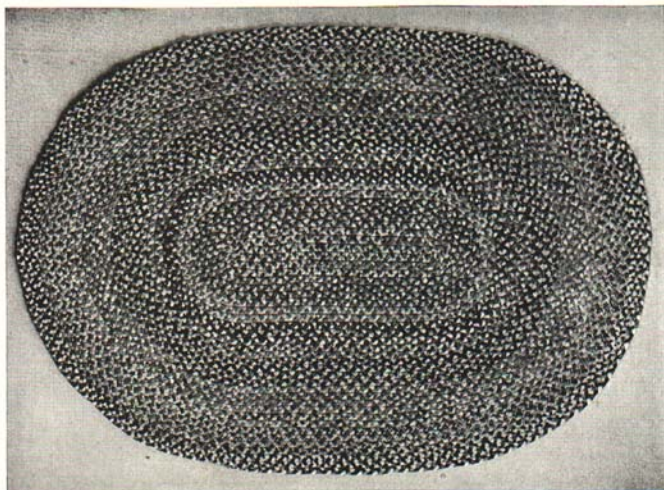

FIGURE 5. AN ALL-OVER PATTERN RUG WITH NO STRONG CONTRASTS IN COLOR IN THE GROUPS OF BRAIDS

Another aid to the appearance of flatness is the repetition of one strand of the same color in every braid throughout the rug. This color may be of one tone or it may vary a little from light to dark or from dull to bright. The other colors in the braids may vary the same way. It is easier to collect materials of many tones of one or more colors than materials of many different colors.

A third aid to flatness is to use only materials of about the same weight or thickness in one rug.

Selecting the Fabrics

Suitable Materials

Medium-weight or slightly heavy fabrics make a good braided rug. Thin materials, such as gingham, muslin, chiffon, silk, rayon, and very light-weight wool as found in some shirts, aprons, dresses, underwear, curtains, sheets, and the like, make a thin narrow braid that does not stand wear and a rug that rumples easily when walked upon. The very heavy materials of cotton or wool, found in heavy blankets, heavy bath-ropes, pile fabrics and the like, produce braids that are thick, too wide, and clumsy.

Wool makes the best braided rug because it is soft and resilient yet

heavy enough to lie flat on the floor, wears well, holds its colors, washes well, and is easy to sew. But such material is not abundant and may not be available.

Cotton makes a good rug but one that is heavier and usually not so soft as a rug of wool. Some cottons fade and are often difficult to wash clean. Cotton is less expensive than wool. It is difficult to get a large needle through cottons that are tough and closely woven. For easy sewing it is wise to select cottons that are soft and pliable, with a slightly open weave; never those that are sleazy, with a loose and very open weave.

New and old materials may be used together in a rug, but they must be either all wool or all cotton. The two fabrics together produce an irregular tension and an uneven rug.

Color Variety

Plain materials, as well as those with stripes, checks, plaids, and floral designs, are needed. Among the figured materials those with an all-over pattern or with a dominating color are best, but all kinds may be used. One should collect large quantities of materials in colors that match or are as nearly as possible like those in the color scheme selected for the rug. All need not exactly match.

Color Fastness

Because most home-dyed materials fade, it is impractical to use such fabrics in a braided rug. Old materials do not fade at all or very little, and most of the new commercially dyed ones retain their color for a reasonable length of time.

Amount of Material

It often takes a long time to collect braided-rug materials, because the best colors and the right cloth are not always available. It pays to be particular. About one pound of medium-weight wool material is needed for each square foot of rug. Three square yards of medium-weight wool material weighs about one pound.

Suitable Used Materials

For wool rugs

Medium-weight wool blankets, upholstery materials, or other household textiles. Men's, women's, and children's medium-weight wool clothing such as:

Petticoats

Underwear

Socks and stockings

Cloth suits, coats, pants, skirts

Coat linings	Knitted suits and dresses
Sweaters	Bathing suits
Bathrobes	

For cotton rugs

Men's, women's, and children's clothing, such as:

- Heavy cotton knit underwear
- Cotton sweaters
- Overalls
- Corduroy from pants or coats
- Heavy cotton aprons, dresses, shirts

Household textiles such as:

- Feed and seed bags (plain and figured)
- Burlap bags
- Bed ticking
- Cretonne from draperies, slip covers, cushion covers
- Heavy sheets and pillow slips
- Tablecloths
- Bedspreads
- Linen dusters

Purchased Materials

New pieces and remnants from:

- Clothing factories (during cutting season)
- Jobbers
- Cotton or woolen mills
- Mill-end shops

Old clothing and used material from:¹

- Paper mills (torn or worn "felts")
- Junk dealers
- Rummage sales
- Second-hand clothing stores

Equipment

Sharp scissors	Iron (a steam iron is good)
No. 8 linen carpet thread	Lead pencil
No. 20 cotton thread	A few large safety pins
Large long-eyed needle	Small clamp, heavy cord or large
Pins	safety pin for holding strips of
Tape measure	material to table while braiding
Thimble	Table
Pressing cloth	Chair

¹Small pieces, good for braided rugs, are sold by the pound for less than the large remnants that are good for the same purpose.



FIGURE 6. EQUIPMENT AND MATERIALS

Preparing the Fabrics

From old garments only parts strong and unworn enough to be durable are used. All old material should be thoroughly washed and pressed before work is begun; all the seams should be opened or cut off, and buttons, hooks, and other fasteners removed. New material should be shrunk before being braided.

Making the Strips

Cutting

Cut heavy materials into strips from $2\frac{1}{2}$ to $2\frac{3}{4}$ inches wide.

Cut medium materials into strips 3 inches wide.

Cut thin materials into strips 6 inches wide and fold the strips double, or cut strips 3 inches wide and pad them with material of the same color.

Strips from 1 yard to $1\frac{1}{2}$ yards long are the easiest to braid. They are cut on the straight of the goods, either across the width or down its length. Some cottons may be torn, but woollens should always be cut.

Folding

Fold in the raw edges of the strip to the center line (figure 7,A and B), dampen, and press with a hot iron.

Bring the folded sides together, with the raw edges inside (figure 7,C), dampen, and press again.

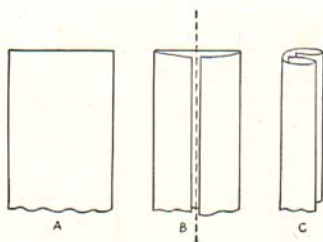

FIGURE 7. FOLDING A STRIP

- A. Strip cut for folding
 B. Sides folded to center
 C. Folded sides turned in

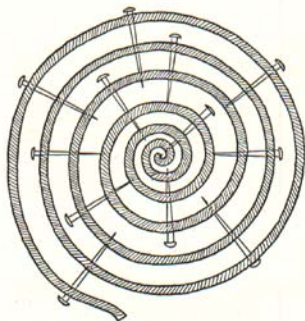

FIGURE 8. ROLLING THE STRIPS

Strips of one color are rolled together to keep them well pressed and neat. The pins, inserted here and there, hold the strips in place

(These two processes can be done at one time and with one pressing, and some materials may need basting.)

The completed strip should be about $\frac{3}{4}$ inch wide. All the strips for one rug should be of the same width.

Rolling

Wind the strips into flat rolls, as tape is rolled (figures 6 and 8). Thrust a pin all the way in here and there and at right angles to the strip to keep it in place (figure 8).

Making the Braid

Size

The best braids are firm and closely made and are from $\frac{3}{4}$ to 1 inch wide. Braids much wider than 1 inch are clumsy and often loose. Those much narrower may look well in very small rugs, but usually are too fine and thin for a large rug and increase the number of rows sewed to the rug. A loose braid makes a soft, limp, rug that stretches badly.

Beginning the braid

Select two long folded strips. Hold one with its open side upward. With a pin, make off one-third of the length of the strip. At this point sew the end of the second strip at right angles to it and with its open side toward the right hand (figure 9, A). There are now three ends, each of a different length. With the right hand, bring end 2 across end 3 (fig-

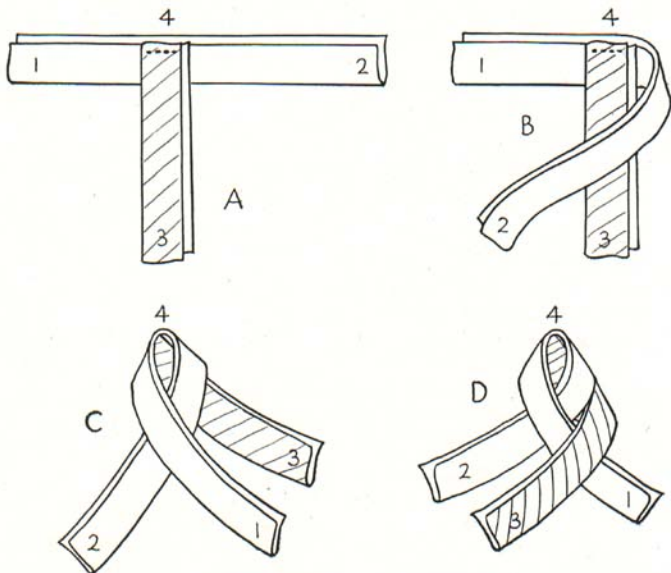

FIGURE 9. BEGINNING CLOSED END OF BRAID

- A. Place the strips at right angles and sew together at 4. Have the open edge of 1-2 up and of 3-4 to the right
- B. Fold 2 to the left, keeping the open fold up
- C. Fold 1 across 2 and to the right, keeping the open fold up
- D. Fold 3 across 1 and to the left, keeping the open fold up. Pin and fasten this end with a clamp to a table. Continue to fold over and braid as before, beginning with 2

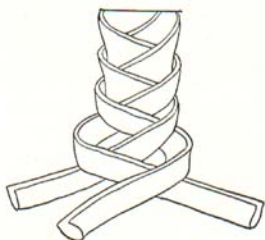

FIGURE 10. A FLAT, TAILORED BRAID

Fold the strips over the front of the braid, with the open side of the strands always facing up. The closed side of the strips show on the outside edge of the braid.

ure 9,B); then, with the left hand, fold end 1 across to the right side (figure 9,C), then cross 3 over 1 (figure 9,D). To make a firm braid, fasten this end with a cord, pin, or clamp to a strong support, such as a table top or leg, a door knob, chair back, or the like, and pull back a little on each strip as it is braided. Continue working until the braid is finished. Always fold the open edges of the strip toward the center, and keep the closed edges on the outside of the braid (figure 10). This process makes a flat smooth braid and a smooth rug.

If one strip is kept much shorter than the other two, the ends are less likely to tangle.

Sample braids

Plait several braids about 1 foot long, making different color combinations of the colors selected from the room. Have one strand of the same color in all the braids. This color may vary from dark in some braids to light in others or it may be one tone in all the braids. Try such combinations as:

- 2 strands of one bright color and 1 strand of a neutral color.
- 3 strands of different colors.
- 2 strands of plain and 1 of figured material.
- 2 strands of figured and 1 of plain material.
- 3 strands of different figures and many others.

Fasten the end of each braid securely with a rubber band or safety pin. From these short sample braids select for the rug the three or four types and colors that seem to combine well in color and pattern.

An Oval All-Over Pattern Rug

For an all-over pattern rug, one continuous braid is sewed around and around an oval center until the size desired is obtained. All braids are of mixed colors, but those of one color are sometimes used for a few of the outside rows. Using colors more or less alike in tone, not varying too greatly from dark to light, and all mixed braids, help to conceal the break that shows when a change of color is made (figures 1, 2, 3, 4, and 5).

Planning Size and Shape

Making the paper pattern

A rug planned from a paper pattern generally is easier to make, is better looking, and fits the space it was made for better than does one not so planned. Plain heavy paper, such as wrapping paper, is suitable.

Determining the length of center braid

For an oval rug, the length of the center braid determines the final length and width of the finished rug. To get the length of the center braid, measure the width of the paper rug pattern and subtract this amount from the length of the pattern. The difference between the two is the length of the center braid (figure 11, *A-A*). Many makers of braided rugs are inclined to reduce the length of the rug center a few inches either through tight sewing or hard pulling of the braids. To correct this error, the original length of the rug center may be increased from 1/4 to 1/5 of its length according to each worker's need (figure 12, *B-B*).

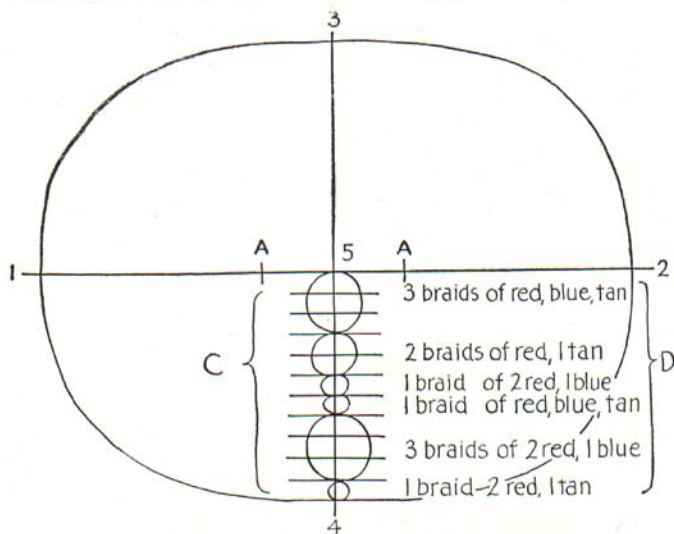

FIGURE 11. PAPER PATTERN AND PLAN FOR GROUPS OF BRAIDS

Cut a paper pattern the size and oval shape that fits the space where the rug will be used. Draw through the center the lines 1-2 and 3-4. Subtract the length of line 3-4 from that of line 1-2. The remainder *A-A* will be the length of the center of the rug.

Use the width of a braid to check on line 4-5 the number of rows of braids needed. Divide these rows into groups and draw penciled lines around them (*C*). Do not have the same number of braids in all groups. Select the braid to be used with each group, and write it down as at *D*.

Making the Braid Plan

Number of rows of braids needed

Measure the width of the braid. With this for a guide, use a pencil to check off from the center line to the edge of the paper pattern the number of rows of braids that will be needed to complete the rug (figure 11,C).

Arrangement of braids

On the paper plan, divide these rows of braids into groups and mark each with a circle (figure 11,C). To avoid the monotony that may come from using an even number of rows in each group, vary the number so that there will be several rows of one kind in one group and more or less than this number in other groups; sometimes one row only of a given kind may be enough.

Rug centers may be large, medium, or small. Borders may be wide or narrow. The width of the center and of the border depends on the size and the design of the rug.

Selecting the braids

From the short sample braids, select the three or four types that seem to combine well in color and pattern. Place one of these braids in each pencil-marked group on the paper plan, arranging them from the center to the edge. For a guide, indicate with a pencil the order in which the selected braids will fall (figure 11,D).

To hold the color scheme together, repeat some of the braid groups at least twice in the rug — once in an area of several rows and again in another area of one or a few rows. Centers and borders may be light or dark; they may be alike or different in color (figures 1, 2, 3, and 4) or there may be no decided center or border (figure 5).

Sewing the Braids Together

Make a braid more than twice as long as the planned center (figure 12, B-B). If you can sew without diminishing the length of the center, then use the center measurement (A-A). Double and sew the braid together, beginning at the looped end (figure 12). Note that the end of the braid begins inside of left B but the loop goes outside of right B.

To join the braids, sew between them with double strands of linen carpet thread; use the blind- or slip-stitch so that stitches will be invisible on both sides of the rug (figure 13). This plan protects the stitches from wear and makes both sides of the rug usable. Place the stitches close together so that there will be no holes between the braids. Pull the thread tightly enough to hold the braids closely together but not enough to draw up or cup the rug.

At all times the braid that is being sewed to the rug is held next to the

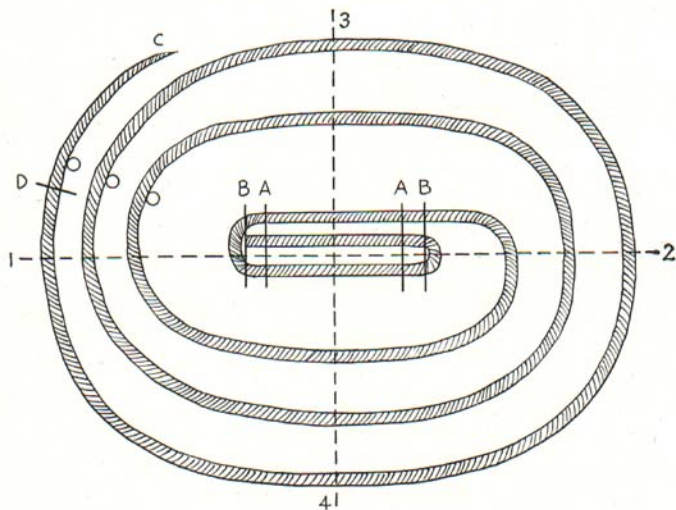

FIGURE 12. SEWING AND FINISHING THE RUG

- A-A.* Real center of rug (page 15)
B-B. Elongated center that should be the same length as *A-A* when completed (see pages 15 and 16)
Left B. Braid-end begins here above the center line, then passes around outside of right *B*, then outside of left *B*
O. Where change of color in the braid takes place
C. Where tapered braid ends
D. Tapered ends are cut back to here

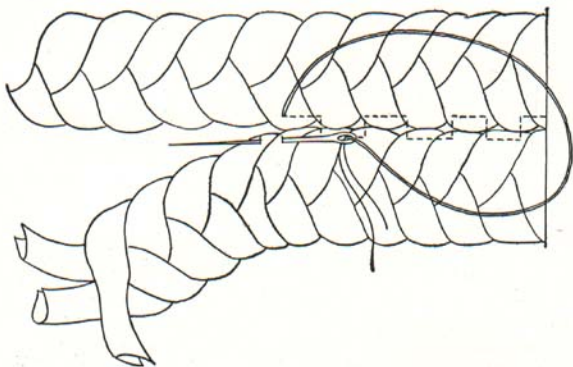

FIGURE 13. SEWING THE BRAIDS TOGETHER

Bend the braids slightly at an angle to each other and sew between them, using the slip-stitch and double strands of linen carpet thread. It is important that the stitch goes directly across from one braid to the other and not at an angle.

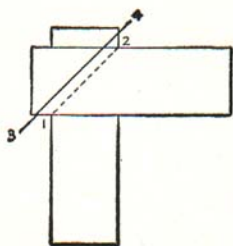

FIGURE 14. JOINING THE STRIP

Cross the ends of the two strips at right angles to each other, with right sides of cloth together.

Sew with back stitch or stitch with machine from point 1 to point 2.

Cut from point 3 to point 4, and press open the seam.

worker (figure 13), and the rug is kept flat on the table. In the final stages, a very large rug is kept on the floor during the sewing. Increase the length of the braid only a foot or two at a time and then sew it to the rug.

Adding New Strips to Braid

Add a new strip only as a strand becomes short. All joinings are made by cutting the ends of both strips on the true bias and sewing or stitching them together with size-20 cotton thread (figure 14). Do not make more than one joining at one place in the braid, for several in one place cause a bulge.

Changing the Color

All changes of color in the braids should be made on a curve of the rug in a line opposite the point where the first braid began (figure 12,O).

Finishing the Rug

Ending the braid

The end of the braid where the rug is to be finished should taper (figures 2, 3, and 4), but the length of the tapering depends on the size of the rug. For a 4-by-5-foot or larger rug, the braid should decrease in size for about 2 feet.

Let the end of the full-sized braid (figure 12,C) extend beyond the regular stopping place for the change of color in the braid (figure 12,O). Ravel the braid a little back of this point to figure 12,D, and pin the strands together here to keep the braid firm.

Cut each unbraided strand to a long tapering point (figure 12,C to D). Fold, press, or sew in the edges, and rebraid.

Sew the tapering braid in place in the same way that the full-sized one was sewed. Poke the end of each strip separately into a different opening of the braid beside it (figure 15), and sew securely there with all rough ends concealed.

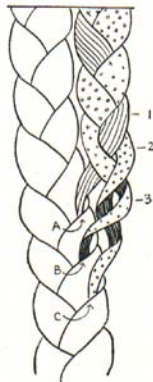

FIGURE 15. ENDING THE ALL-OVER PATTERN

End the braid so that the two tapered strands of braid 1 and 2 lie to the outside of the braid and strand 3 faces in toward the rug. Strand 1 crosses over to the rug and enters between the strands of braid at A. Twist strands 2 and 3 once together and insert strand 3 at B and strand 2 between the folds at C. Pull tight, push the strands to the edge of the braid, and sew securely in place under the folds.

Pressing the rug

Pressing a rug sometimes helps to give it a more finished appearance. Lay a damp cloth over it and press until the rug is dry. Allow the rug to lie flat for several hours before walking on it.

A Round Rug

Prepare a firm braid as for the oval center (page 13). Bend the closed end of this braid into a tight coil and sew it securely without cupping. Never use a cupped coil. Continue sewing around and around this coil. To prevent cupping at the center, "full on" or push backward on the inside edge of the first few rows of braids, easing in the fullness as they are sewed in place. Pressing does not remove cupping. After a flat center of several rows has been obtained, gradually cease pushing back so much on the braid and continue until the rug is finished.

If the rug cups in the center or if it is wavy around the edges, the braid has been drawn too tightly throughout the rug or too much fullness has been eased in, or the thread has been drawn too tightly.

The same directions for planning, designing, and finishing an all-over-design oval rug are followed in making a round rug.

A Striped Oval Rug

In a striped rug each braid is completed and sewed to the rug, then the ends are joined before the next row is begun (figure 16). The joining of the ends of each row should be invisible. The rug may be made of braids of mixed colors, or braids of solid but different colors, or braids of mixed and of solid colors.

The selection and preparation of materials, the planning, and the sewing of this rug are the same as for the all-over pattern braided rug.

The Color Scheme

This rug may be made more striking in design and color than one with the all-over pattern because of the contrast between plain and mixed braids and because there is no break where a change of color is made. All braids of mixed colors greatly soften this strong effect. It is best for the designer not to have too great a contrast between the plain and figured braids or to have rows of strong colors or of black in contrast to light and pale colors, for either has a target effect, and such a strong circular movement in the rug usually is unsatisfactory.

Not more than three colors that harmonize or contrast make an effective color scheme. The center or the outside edge of the rug may be: light, medium, or dark in color, of plain or mixed colors, and narrow or wide. The color throughout the rug may graduate from light to dark or the reverse.

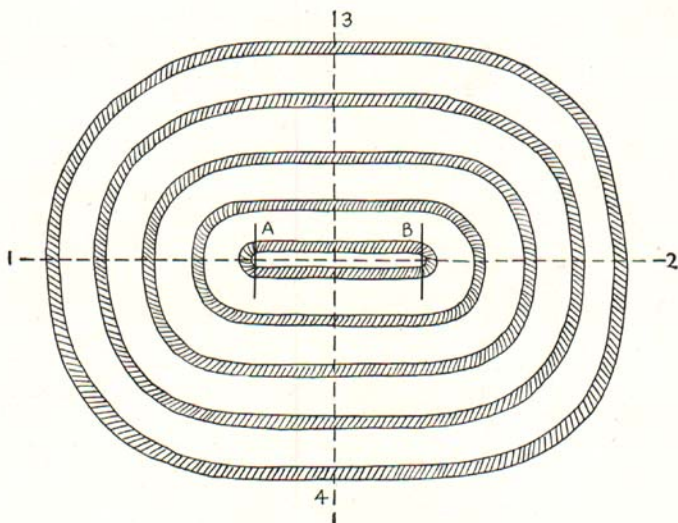

FIGURE 16. THE STRIPED RUG

Each row of braid forms a complete circle (page 19) and the joining of the ends does not show. Therefore, it is possible to use plain-colored braids as well as mixed ones in the same rug. A-B indicate the length of the center of the rug.

Each group of three or more rows may graduate from light to dark. A repetition of color throughout the rug is good. Trial braids should be placed on the paper plan as for the all-over pattern rug (page 16).

Making the Rug

Braiding

Make the braids firm and each of the required length plus 8 inches, before sewing it to the rug. Pin together the loose strands at each end to keep the braid firm throughout.

Sewing the braid

For this rug all braids *must* end at different places on the rug, not opposite one spot in the center as for the all-over pattern rug with the continuous braid. This method makes a stronger rug.

All the braids must run in one direction, with the same side up.

Pin the braid to the rug with large safety pins. At the stopping point let the extra 4 inches at each end remain free. This method of temporarily securing the braid to the rug permits the proper adjustment of the

tension of the braid before sewing it to the rug and helps to prevent cupping and rippling. Sew the braid in place following the directions for the all-over pattern rug (figure 13 and page 16).

Ending the braid

Of the several ways to join the ends of this braid, two of the best are the following:

SIMPLE METHOD:

With the simple method, the rug is strong but inclined to be bumpy where the ends of the braids join, and the seams show on the right side. Only one side of the rug can be used as the top side.

Turn the beginning and the final projecting 4-inch braided ends upward at right angles to the rug (figure 17). Pin them together so that



FIGURE 17. STRIPED-RUG BRAID ENDING — SIMPLE METHOD

Bend the two ends of the braid upward at right angles. Hold them firmly together, and sew together at the bend A-B. Use two strands of No. 20 cotton thread

the braid fits neatly to the rug. With double strands of cotton thread sew the ends together in a seam so that they will not pull apart (figure 17 A-B).

Cut off the projecting ends about 1 inch from the seam. Cut out the under side of the ends to eliminate bulk. Fold under both sides of all strips to prevent raw edges. Press the seam open and sew the ends down on the braid. Complete the sewing of the braid to the rug.

COMPLEX METHOD:

With the complex method, the rug is strong and smooth, and no seams show where the braids join at the ends. Either side of the rug may be used as the top side.

Lap the final 4-inch end over the beginning 4-inch end so that the strips

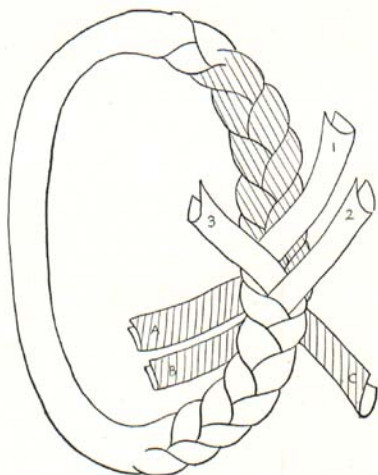

FIGURE 18. STRIPED-RUG BRAID ENDING — COMPLEX METHOD

Pass strands 1, 2, and 3 downwards and follow strands under them
Turn the braid over

makes the joined ends about the same thickness as the rest of the braid.

On the two-strip side of the top end, fold strip 1 under the lower braid end following the one below it, and pull it under the first crossing strip (figure 19). Take strip 2 and pass it below and then under the immediate crossing strip (figure 19). Fold the single strip 3 under the lower braid end and draw it under that crossing strip (figure 19). Pull the strips so their tension is the same as that in the rest of the braid. Sew them firmly in place under the crossing folds and cut off the ends so they do not show. If these ends are carefully tapered and some of the under part of the fold is cut away, the ending is less bulky.

Unpin and unbraid the lower end of the

of the upper one lie over those of the lower (figure 18). Fasten them together with a pin at a point midway between both ends of the overlapping braid.

Unbraid the strips of the end lying on top so that two strips project on one side of the braid and one on the other and each strip lies over the one directly below it in the other end of the braid (figure 18). Cut out the under side of the strips where they pass over the braid and under the crossing strips, keeping all raw edges turned under. This

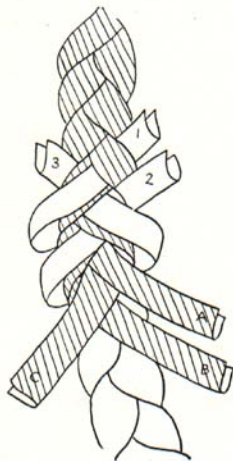

FIGURE 19. STRIPED-RUG BRAID ENDING

Insert strands 1, 2, and 3 under the crossing folds; Pull them tight; and sew in place under the crossing strand. Cut off the projecting ends

braid and bring each strip, *A*, *B*, and *C*, over the top of the upper end, each following directions for 1, 2, and 3 (figure 19). Adjust the tension and sew the ends in place as described. Sew this part of the braid to the rug. Continue with the other braids until the rug is completed.

Issued February 1947
Second Printing October 1947
Third Printing September 1950

Cooperative extension work in agriculture and home economics, Michigan State College and the U. S. Department of Agriculture, cooperating. C. V. Ballard, Director, Cooperative Extension Service, Michigan State College, East Lansing. Printed and distributed under Acts of Congress, May 8 and June 30, 1914.

9-50:7.5M