

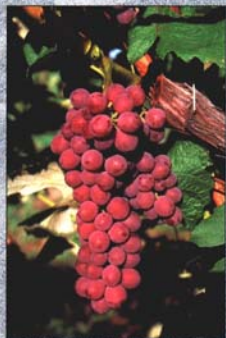

Growing Table Grapes in a Temperate Climate

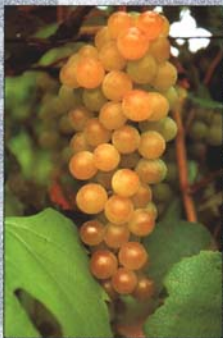

Thomas J. Zabadal
Department of Horticulture

*Graphics by Diane Dings
Illustrations by Laurel Breyer*

MICHIGAN STATE
UNIVERSITY
EXTENSION



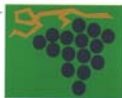

Acknowledgments

This publication results from more than a quarter century of experience with growing table grapes in the temperate climates of New York and Michigan. Many growers in New York and Michigan were involved in experiments, trials, demonstrations and commercial table grape production on their farms. Dr. Bruce Reisch, Dr. Jim Moore, Elmer Swenson and Dr. Helen Fisher provided table grape plant material to be planted at the Southwest Michigan Research and Extension Center (SWMREC). Dr. Stan Howell, Dr. Dave Miller and Dr. Charles Edson made the first plantings of table grapes at SWMREC. Many SWMREC staff members — including Jim Ertman, Gaylord Brunke, Fred Froehlich, Tom Dittmer and Cassie Meier — have contributed to the management of table grapes planted at SWMREC. Thanks to Diane Dings and Laurel Breyen for contributing computer graphics and illustrations, respectively. Those contributing helpful comments on the manuscript include Jeanne VanNewenhizen, Wayne Baker, Joe Herman, Jordan Tatter, Al Lange, Dr. Jim Flore, Dr. Garth Cahoon, Dr. Stan Howell, Dr. Don Ramsdell, Dr. Ron Perry and Dr. Nick Dookozlian. An anonymous donor provided significant funding to defray the cost of publishing this manuscript. The Michigan Agricultural Experiment Station has funded many table grape projects that have contributed information in this publication. Thanks to MSU ANR Communications staff members Alicia Burnell, Leslie Johnson and Ken Fettig for editorial, graphic design and print production coordination.

Diane Dings deserves special recognition for guiding the manuscript through numerous stages. Her dedication made this publication possible.

Products are mentioned in this publication for informational purposes only, and such mention does not constitute endorsement by Michigan State University or imply discrimination against unmentioned products. Individuals should check current product registrations of all materials before purchase and use.

the 1990s, the number of people in the UK who are aged 65 and over has increased from 10.5 million to 13.5 million, and the number of people aged 75 and over has increased from 4.5 million to 6.5 million (Office for National Statistics 2000).

There is a growing awareness of the need to address the needs of older people, and the need to ensure that the health care system is able to meet the needs of older people. The Department of Health (2000) has published a strategy for older people, which sets out the government's commitment to older people and the need to ensure that the health care system is able to meet the needs of older people.

The strategy for older people (Department of Health 2000) sets out the government's commitment to older people and the need to ensure that the health care system is able to meet the needs of older people. The strategy is based on the following principles:

- Older people should be able to live independently and actively in their own homes.
- Older people should be able to access the services they need to live well.
- Older people should be able to participate in decisions about their care and services.
- Older people should be able to live in a safe and secure environment.
- Older people should be able to access the services they need to live well.

The strategy for older people (Department of Health 2000) sets out the government's commitment to older people and the need to ensure that the health care system is able to meet the needs of older people. The strategy is based on the following principles:

- Older people should be able to live independently and actively in their own homes.
- Older people should be able to access the services they need to live well.
- Older people should be able to participate in decisions about their care and services.
- Older people should be able to live in a safe and secure environment.
- Older people should be able to access the services they need to live well.

The strategy for older people (Department of Health 2000) sets out the government's commitment to older people and the need to ensure that the health care system is able to meet the needs of older people. The strategy is based on the following principles:

- Older people should be able to live independently and actively in their own homes.
- Older people should be able to access the services they need to live well.
- Older people should be able to participate in decisions about their care and services.
- Older people should be able to live in a safe and secure environment.
- Older people should be able to access the services they need to live well.



Table of Contents

Introduction	4	Vineyard Fertilization	22
Section I – The Structure of a Grapevine	4	Insect and Disease Control	22
Shoots, Laterals, Trunks, Arms and Cordons	4	Strategies for a Pesticide Spray Program	23
Nodes, Internodes, Fruiting Canes and Fruiting Spurs	6	Controlling Animal Depredation in Table Grapes	24
Renewal Zone, Renewal Spurs and Vine Space	6	Section IV – Special Practices to Produce Quality Table Grapes	26
Suckers and Trunk Renewals	7	Crop Adjustment	27
Section II – Getting Started	9	Flower Cluster Thinning	29
Selecting, Designing and Preparing a Vineyard Site	9	Cluster Thinning	30
Selecting Grape Varieties to Plant	10	Berry Thinning	31
Planting and Care of Young Vines	11	Gibberellic Acid Sprays	32
Section III – Cultural Practices For Managing Mature Grapevines	13	Girdling	32
Grapevine Training Systems for Table Grape Production	13	Shoot Positioning	35
Modified Munson Training	13	Brushing	36
Modified 4-Arm Kniffin	15	Shoot Topping	37
Hudson River Umbrella	15	Section V – Harvest, Storage and Marketing of Table Grapes	38
Fan Training	16	Harvesting Table Grapes	38
Arbor Training	16	Storing Table Grapes	38
Pruning Vines for Table Grape Production	18	Marketing Table Grapes	39
Pruning Severity	19	Appendix A – Available Publications	40
Selecting Fruiting Canes	20	Appendix B – Sources of Materials for Table Grape Production	42
Steps in Pruning	20	References	43
Spring Vineyard Chores	22		

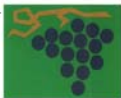

Introduction

Table grapes have become a very popular fruit in the United States. Annual per capita consumption of table grapes in the United States has quadrupled over the past quarter century. It now exceeds 7 pounds per person, and grapes rank fourth after bananas, apples and oranges. Improved storage technology and extensive winter importation now make table grapes available year round.

Though the major U.S. table grape production regions are in warm climates such as the San Joaquin Valley of California, many areas with temperate climates have potential for exciting and profitable production of flavorful table grapes. Temperate climates are those that may have a warm growing season but have other temperature-related characteristics that challenge

grape production. These may include frost-free growing seasons of 165 days or less, winter minimum temperatures of -5°F or lower, and growing season heat accumulations of 3,000 growing degree-days or less (base 50°F). Breeding programs have developed table grape varieties well suited to temperate climates. With the proper varieties and good management, it is possible to grow flavorful, high quality table grapes. This publication guides growers to that goal and complements several other publications in this series: *Vineyard Establishment* (Zabadal, 1997; Zabadal and Andresen, 1997), *Table Grape Varieties for Michigan* (Zabadal et al., 1997) and *Pest Control in Small Vineyards* (Zabadal, 1999). Sources of these publications are listed in Appendix A.

Section I – The Structure of a Grapevine

Whether you are a backyard viticulturist with no grape growing experience or a veteran grape grower, all efforts to grow table grapes must begin with an understanding of the aboveground structure of a grapevine.

Shoots, Laterals, Trunks, Arms and Cordons

The structure of a grapevine is really quite simple. Trunks and arms are the rough-barked, semi-permanent woody parts of the vine. A **trunk** is easy to identify because it originates at or near the ground like the trunks on other woody plants (Fig. 1a). There can be one, two or several trunks on a grapevine. When a

trunk divides into branches, these branches are called **arms**. Arms are rough-barked portions of the vine other than the trunk(s). Sometimes a trunk is bent so a horizontal arm runs along a trellis wire. This horizontal arm is then called a **cordon** (Fig. 1f). New vine growth begins each year with **primary shoots**, which are the elongating green tissues with leaves. Primary shoots often develop side branches, which are called **lateral shoots**. As a vine matures in the latter part of the growing season, shoots become woody from their base outward. After the leaves fall from the vine, these smooth, tan or brown woody vine parts are called **canes**. Lateral shoots that become woody are called **lateral canes** or simply **laterals** (Fig. 1f). As the shoots are maturing into woody canes in the latter part of the growing season, the canes from the previ-



Section 1 – The Structure of a Grapevine

Figure 1

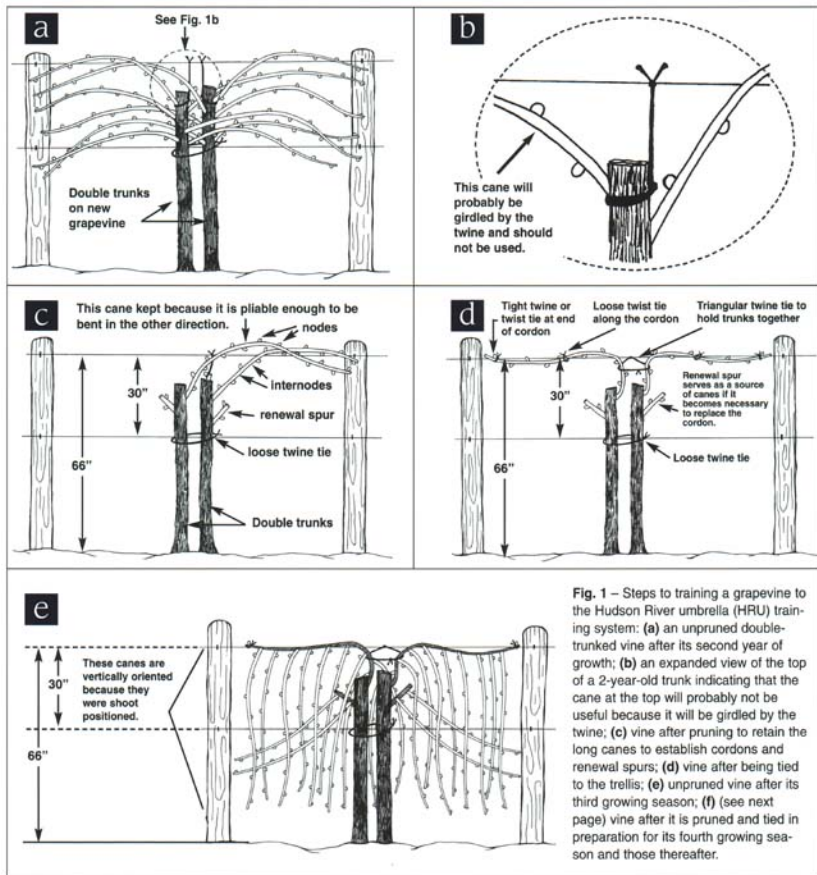
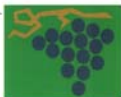
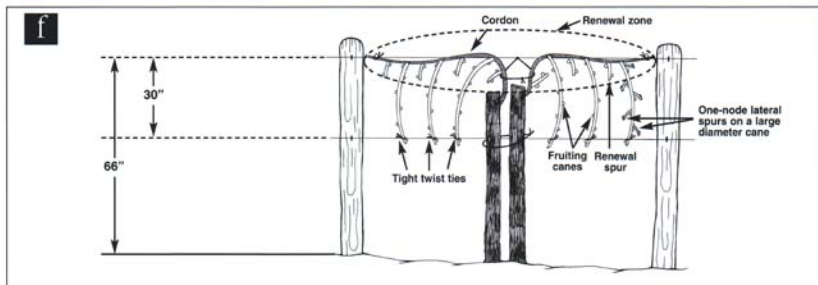

Fig. 1 – Steps to training a grapevine to the Hudson River umbrella (HRU) training system: (a) an unpruned double-trunked vine after its second year of growth; (b) an expanded view of the top of a 2-year-old trunk indicating that the cane at the top will probably not be useful because it will be girdled by the twine; (c) vine after pruning to retain the long canes to establish cordons and renewal spurs; (d) vine after being tied to the trellis; (e) unpruned vine after its third growing season; (f) vine after it is pruned and tied in preparation for its fourth growing season and those thereafter.



Section 1 – The Structure of a Grapevine

Figure 1 (continued)



ous year are developing a rough-textured bark. After the leaves fall from the vine in the fall, the rough bark characteristic of the 2-year-old or older portions of the vine distinguishes them from the smooth-barked current-year canes.

Nodes, Internodes, Fruiting Canes and Fruiting Spurs

Canes, the smooth-barked woody parts of the vine, are very important to the grower. They have enlarged areas along them called **nodes** (Fig. 1c). A node is a **compound bud** composed of: a primary bud, which typically produces two-thirds or more of the fruit; a secondary bud, which produces up to one-third of the fruit; and a tertiary bud, which produces little or no fruit (Fig. 2a). The smooth areas of a cane between the nodes are called **internodes** (Fig. 1c). Canes may be pruned to varying lengths. If they are pruned to one to three nodes, they are called **fruiting spurs**. Canes left longer and pruned to four or more nodes are called **fruiting canes**. Fruiting spurs are seldom used for table grape production in a temperate climate because the nodes at the base of canes often produce small, straggly clusters. Therefore, fruiting canes with at least 6 and up to 15 nodes are typically used for temperate climate table grape production (Fig. 1f).

Renewal Zone, Renewal Spurs and Vine Space

A vine must be managed to occupy its own specific space along a vineyard trellis. The portion of a trellis reserved for a vine is called its **vine space**. A vine is contained within its vine space through a combination of vine management practices including choice of training system, pruning, shoot positioning and fertilization. The **renewal zone** of a grapevine is the area within that vine space from which fruiting canes (or fruiting spurs, when these are used) originate. The precise location and shape of a renewal zone will depend on the vine training system being utilized. For example, when a modified 4-arm Kniffin training system is utilized (Fig. 3b), the fruiting canes originate from a renewal zone in the middle of the vine space near the top wire of the trellis. Therefore, in this example, an experienced pruner's eyes will concentrate on that portion of the vine to locate the desired fruiting canes. The concept of a renewal zone is important because it focuses the pruner's search for fruiting canes. There is no need to comprehend the entire tangled structure of a vine to prune it properly.

There is no guarantee that a pruner will find fruiting canes in the renewal zone if previous pruning prac-



Section 1 – The Structure of a Grapevine

Figure 2a



Fig. 2a – A longitudinal view of a grape node revealing a primary (center), secondary (right) and tertiary (left) bud surrounded by bud scales.

tices have not encouraged shoot growth in that area of the vine. Therefore, a grapevine pruner must manage the structure of a vine not only for fruiting in the coming growing season but also to preserve the form of the vine for future years. Managing the structure of the vine for future years is accomplished by creating **renewal spurs**. These are canes in the renewal zone of the vine that are not chosen for fruiting but are pruned to one or two nodes (Figs. 1f & 3b) to promote shoot growth. The expectation is that some of the shoots arising from renewal spurs will mature into quality fruiting canes for the following season. Retaining ample renewal spurs makes pruning easier in subsequent years. However, it is also possible to go “spur crazy”. Saving too many renewal spurs causes shoots in the renewal zone to become crowded and develop poorly. Therefore, a general guideline is to create one renewal spur for each fruiting cane left on the vine.

Suckers and Trunk Renewals

The trunk of a grapevine may remain healthy for decades or become diseased or winter-injured after just one or two years. Therefore, the trunks of vines

Figure 2b



Fig. 2b – The cross-section of a node indicating a dead primary bud in the middle with live secondary and tertiary buds on either side.

need to be managed for the specific conditions of a vineyard. Even under the best of conditions, it is good management to replace trunks every 10 to 12 years in a temperate-climate vineyard. Many situations will require more frequent trunk replacement. Establishing new trunks is accomplished by first managing **suckers**, which are shoots that develop from below-ground or near the ground on trunks. (Some prefer to use the term “water sprout” for shoots that develop on the bases of trunks.) When a cane that has matured from a sucker is chosen to establish a new trunk, it is called a **trunk renewal** (Fig. 4). Suckers growing directly from the ground are preferred for trunk renewals on ungrafted vines. When they are not available, utilize canes originating on trunks as close to the ground as possible. On grafted vines, canes from suckers growing above the graft union must be utilized for trunk renewals. Grapevines grown in a temperate climate should typically be managed with two trunks because it is easier to combat the effects of winter injury to vines when each of two trunks services half of a vine space (Fig. 1d). Managing vines with up to four trunks per vine and with one or more of these trunks being replaced each year may be helpful when growing very cold-tender varieties (Fig. 4).



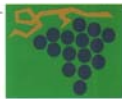

Section 1 – The Structure of a Grapevine

Figure 3

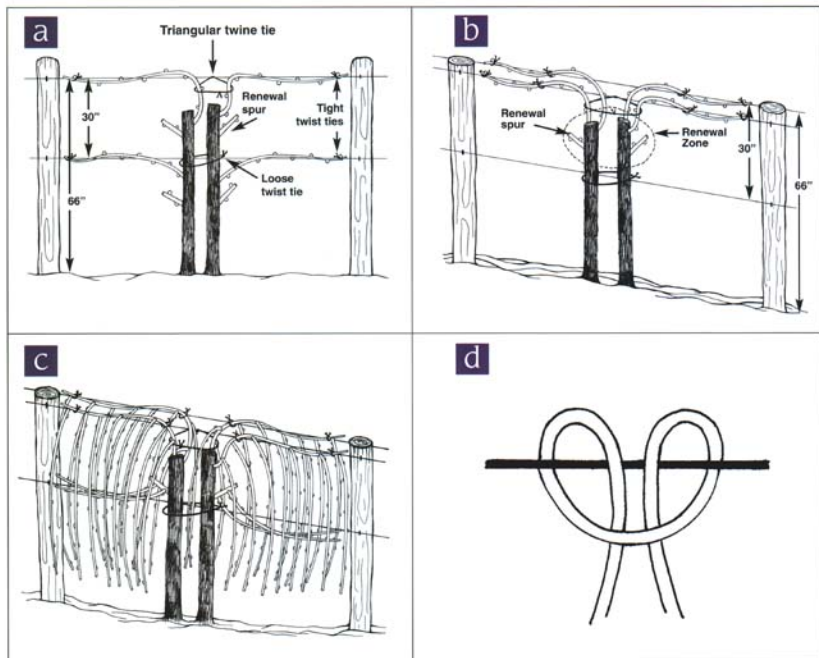
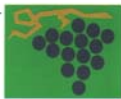

Fig. 3 - Steps to training a grapevine to a modified 4-arm Kniffin training system: **(a)** traditional 4-arm Kniffin training system for fruiting canes tied on two wires at two heights on the trellis; **(b)** modified 4-arm Kniffin training with four fruiting canes tied on two wires at the same height (top) on the trellis; **(c)** vine at the end of the growing season that has been trained to modified 4-arm Kniffin training and shoot positioned during the growing season; **(d)** close-up of the double half-hitch knot used to attach the twine to the wire for the triangular tie.



Section 1 – The Structure of a Grapevine

Figure 4

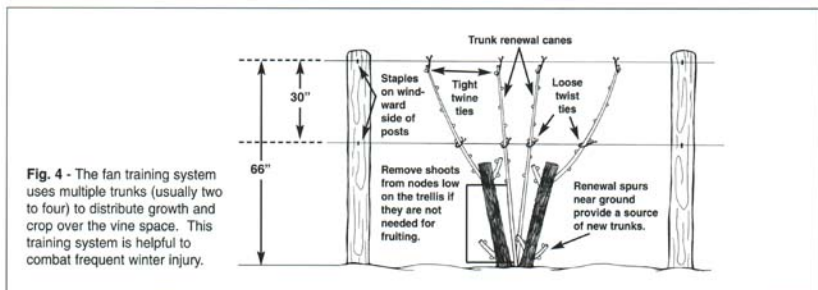

Fig. 4 - The fan training system uses multiple trunks (usually two to four) to distribute growth and crop over the vine space. This training system is helpful to combat frequent winter injury.

Section II - Getting Started

Selecting, Designing and Preparing a Vineyard Site

Grapevines are easy to grow and can live a very long time. Many productive commercial U.S. vineyards are more than a century old. The challenge to the table grape grower is not only to keep vines alive but also to produce quality fruit. Reaching that goal begins with the selection of a proper vineyard site. The commercial grower, who seeks profit, must undertake the selection of a vineyard site methodically by considering several site characteristics: macroclimate, microclimate, topography, soil physical and chemical characteristics, and cropping history. Reference materials (Zabada and Andresen, 1997) are available to assist in that process. The hobby viticulturist is likely to choose a vineyard site on land already owned such as a backyard or by the family cottage. Within that limited framework of choice, the hobby viticulturist should still exert some discretion about where vines are planted. Vines need full sun, not only to promote fruit

maturity but also to reduce disease pressure on vines. Avoid planting under shade trees or in the shade of buildings. Vines do best in well drained soils. They are vulnerable to spring freezes in low-lying frost pockets, so put vines on elevated ground whenever possible. Vines typically grow well over a range of soil acidity (pH) levels. Liming by commercial growers should aim for an optimum soil pH of 6.5. Hobby growers need to lime their soil only if soil pH is less than 5.5. Improve the internal drainage of heavy soils whenever possible. All other plant growth within several feet of a vine will compete with vines for nutrients and water so, whenever possible, establish vines with a minimum 4-foot-wide vegetation-free band under the vineyard trellis (Fig. 5). Eliminate weed growth on a vineyard site several weeks or even a year before planting through a combination of herbicide use and/or cover cropping. Attention given to these details can make the difference between having ugly, small, fruitless vines and attractive, large, orderly vines that produce enjoyable, quality fruit.

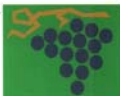

Section II - Getting Started

Figure 5

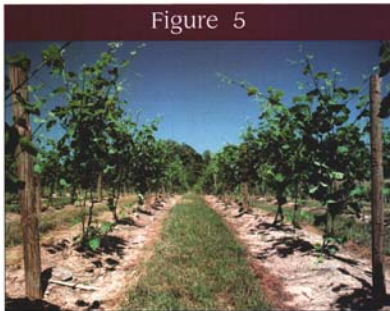

Fig. 5 – Typical vineyard floor management with a minimum 4-foot-wide vegetation-free band under the trellis.

Vineyard design for commercial growers requires attention to several details (Zabadal and Andresen, 1997). The hobby viticulturist should:

- Plant rows of vines, ideally in a north-south orientation, though any orientation that might be dictated by the site can produce quality fruit.
- Plant rows no closer together than the height of the trellis. For example, vines planted on a trellis 6 feet high should be at least 6 feet apart. Wider row spacings up to 9 feet will promote fruit quality. Vineyard row width is most often determined by the equipment (tractor or lawn mower) that will be used to manage the vineyard floor.
- Plant vines no closer than 7 feet apart. Wider spacings (8 to 9 feet) may improve fruit quality but may also reduce the yield of the vineyard.

Selecting Grape Varieties to Plant

More bad table grape varieties are available for purchase than good ones. Don't rush this decision. Though numerous high quality seeded table grape varieties are available for temperate-climate vineyards, the commercial grower should be mindful that

the American consumer now has a 90% preference for seedless table grapes. That's the future, even though a few growers in the eastern United States still fresh-market significant quantities of 'Concord' and 'Niagara'. Hardiness is an important characteristic in table grape varieties for temperate-climate vineyards. Vines will often be injured at temperatures from -5 to -15°F, so commercial growers must carefully choose varieties matched to the low-temperature history of their site. Hobby growers situated on non-traditional vineyard sites will need to choose hardy varieties that will tolerate temperatures of -10 to -15°F or lower. Be careful in making choices. Many named seedless varieties have been unreliable producers over the years. Consult objective printed material (Bordelon, 1995; Cahoon et al., 1991; Reisch et al., 1993; Wolf and Poling, 1995; Zabadal et al., 1997) rather than nursery catalogs for good information about table grape varieties. The experience of others growing table grapes in your area or discussions with local university Extension personnel can also be helpful. Don't assume that vines offered by nationwide retailing chains will be suitable for your backyard vineyard!

Order vines several months or even a year in advance of planting to be assured of availability. Vine quality varies considerably and can be assessed by inspecting the root system. The larger, more fibrously branched the root system, the better it will exploit the soil and support early growth. Vines should have primary roots at least 9 to 15 inches in length. Poor quality vines slow vineyard establishment and can cause a vineyard to fail. Avoid purchasing vines that have been root pruned for convenience of shipping. Grapevines can be infected with viruses and other diseases that can permanently stunt or even kill vines. Unfortunately, there currently are no sources of cool-climate table grape varieties that are certified free of these diseases. Therefore, the only strategy available to growers to reduce their risk of purchasing diseased vines is to select only large, healthy-looking vines with large root systems. In future years, certified planting stock of some cool-climate table grape varieties will be available. A listing of nurseries that sell table grape varieties for temperate climates is available (Zabadal et al., 1997).



Section II - Getting Started

Planting and Care of Young Vines

Plant vines as early as possible in the spring. Keep vines cool and moist from the time you obtain them until planting. If the vineyard site has been adequately prepared (Zabadal and Andresen, 1997), then the steps in planting (Zabadal, 1997) should proceed in rapid succession.

The hobbyist grower with a small number of vines should take the time to plant each vine so the root system is well distributed in the soil volume. Do not merely shove roots down a hole made with a posthole digger. Dig a large hole so roots can be spread out horizontally and vertically. Fill in the hole over the roots with loose soil. Then pull up the vine slightly so the aboveground portion of the vine is at ground level. Planting straight rows of vines in a small vineyard can be accomplished without commercial equipment. Stretch a rope or wire along the ground so it is parallel to and offset 30 inches from the row of vines (Fig. 6). Then use a 5-foot measuring stick to precisely measure the placement of the vine from that wire or rope to the middle of that measuring stick (Fig. 6). There should be a 6-inch mound of soil around vines after planting (Fig. 7). If the canes on these new vines have been pruned back to 6 inches or less prior to planting, then all shoots developing from the vine can be allowed to grow.

Weed control is the single most important vineyard establishment task. Be sure no vegetation grows within a minimum of 24 inches of vines in all directions. Increasing this vegetation-free area up to 48 to 60 inches in all directions from vines may dramatically increase vine growth. If weeds are not controlled around vines, nothing else that you do will promote good vine establishment. Weed control by the hobbyist can be accomplished mechanically (hoeing) or through mulching. Mulching materials can include plastic, grass clippings, straw, leaves, rocks, newspaper held with rocks, etc. When mulching around vines, completely seal the soil surface around vines and eliminate any weeds that escape through the mulch.

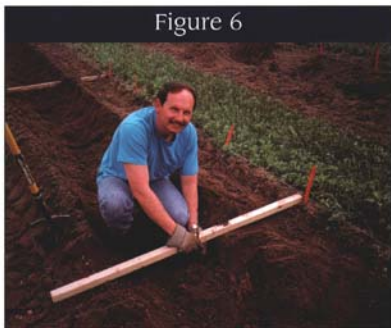

Figure 6
A trench was opened for planting a row of grapevines. A tensioned wire offset 30 inches from the row of vines is used to place the vine precisely in the trench. The measuring stick is 60 inches long with a mark for vine placement in the middle of the stick.

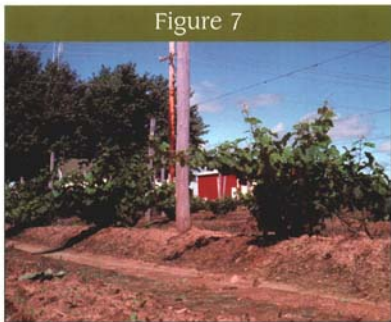
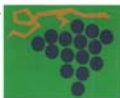

Figure 7
A new vineyard with a 6-inch mound of soil along the row of vines.





Section 11 – Getting Started

Fertilize new vines immediately after planting by ring-fertilizer in a circle 12 inches from the vine. Apply 6 ounces of 12-12-12 or some equivalent garden fertilizer around each vine. Do not use weed-and-feed fertilizer mixes — grapevines are very susceptible to injury from the herbicides in these products.

Keep vines healthy and free of insects/diseases. Pest control information for small vineyard plantings is available in a companion publication (Zabada, 1999). Remove clusters from vines as soon as they develop in the first two years to promote vine establishment. If there is any doubt about the trueness to variety of vines, one or two clusters per vine can be retained as a check.

It is helpful but not essential to establish the trellis in the first growing season for vine support. When a trellis is installed, shoots should be loosely tied to the trellis wires using a combination of twine and twist ties (Fig. 8). Vines can also be grown along the ground in the first growing season and the trellis installed the following fall or spring (Fig. 9). Vines should be pruned before the start of the second growing season so that one (Fig. 10) or two canes (Fig. 1a) are tied to the top wire of a trellis to begin forming the trunks of the vine. Clusters are removed from the vines to promote the vegetative growth of the vine.

Significant cropping is possible for vines in their third growing season if they have been well managed. Poor vine management will delay the full productive potential of vines one or two years or even indefinitely.

Figure 9

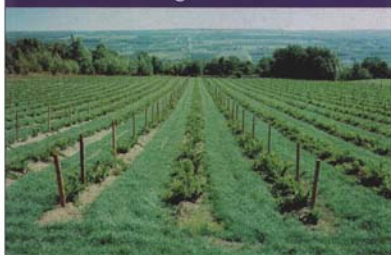

Fig. 9 – A new vineyard with vines that have been grown on the ground in the first growing season. A rye cover crop has been sown in the row middles and trellis posts are being installed. Photo taken in September. Many vineyards are begun in this manner.

Figure 8

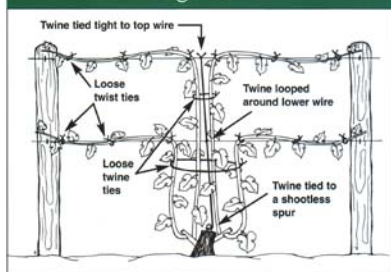

Fig. 8 – Twine and twist ties can be used to tie shoots loosely to trellis wires in the first growing season.

Figure 10

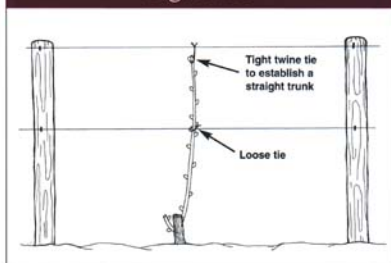
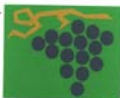

Fig. 10 – This vine has been pruned to a single cane prior to the start of the second growing season and tied to the top wire. The spur at the base of the vine may be needed for an additional trunk in future years.



Section III - Cultural Practices for Managing Mature Grapevines

All cultural practices applied to grapevines are aimed at achieving the goals of acceptable yield and acceptable fruit quality. The intensity of a grower's vine management will reflect what he considers "acceptable" yield and fruit quality. Modest crops of imperfect fruit may be quite acceptable to a backyard grower, but such standards would put a commercial grower out of business. Several good vine management options for table grape production are presented below. Growers need to choose among these options to satisfy their desired intensity of vine management.

Grapevine Training Systems for Table Grape Production

Grapevines are properly managed with a specific growth form. The steps taken to establish this form constitute a training system. From the numerous training systems that have been devised for grapevines, the following are recommended for table grape production in a temperate climate because they promote both fruit maturity and development of highly fruitful nodes on fruiting canes.

Modified Munson Training — This is the best training system for producing table grapes in a temperate climate. It places clusters and the leaves close to them, which ripen the fruit, in a very uniform pattern well exposed to sunlight (Fig. 11). Moreover, this training system facilitates harvest by separating clusters from the entanglement of shoots and puts them at a comfortable height for picking.

The canopy management practice of shoot positioning is an essential complement to modified Munson training. The shoots of grapevines typically grow upward to the top of the trellis, where they shade clusters from the sun (Fig. 12). Shoot positioning (see page 35)

Figure 11

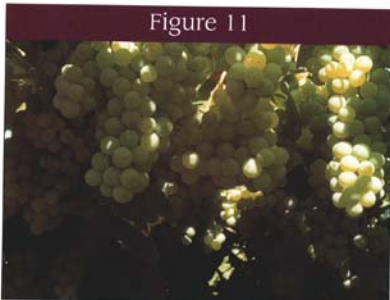

Fig. 11 — Clusters of 'Himrod' seedless table grapes on a vine utilizing a modified Munson training system.

Figure 12

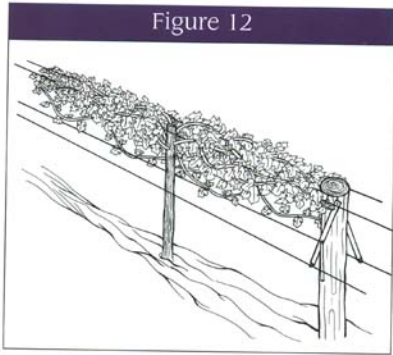
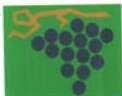

Fig. 12 — A vine with modified Munson training before shoot positioning.



Section III – Cultural Practices for Managing Mature Grapevines

orients shoots from the central plane of the trellis to wires that are supported by cross arms (Fig. 13) and then down vertically. The wires on the ends of the cross arms are called “catch wires” because they catch or support shoots in their desired location. The result is a grapevine canopy with most of the leaves directed away from the clusters to avoid fruit shading. The single layer of leaves that is allowed to develop at the top of the trellis creates a microclimate of filtered sunlight for the clusters.

A grower must be willing to construct a specialized trellis with cross arms (Fig. 14) to benefit from the modified-Munson training system.

Many years of experience with these cross arms suggest that making them collapsible, like an umbrella, makes the task of shoot positioning much easier. At the time of winter pruning, these collapsible cross arms are lowered (Fig. 12) so the trellis appears to be a normal two-dimensional trellis. This facilitates pruning the vines and tying canes to wires at the top of the trellis posts. After the first pass of shoot positioning, the cross arms can then be raised to their outstretched position (Fig. 13). A second touch-up pass of shoot positioning a couple of weeks later will complete the orientation of shoots.

Figure 13

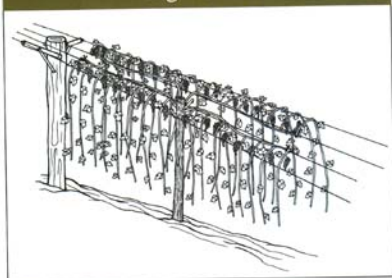
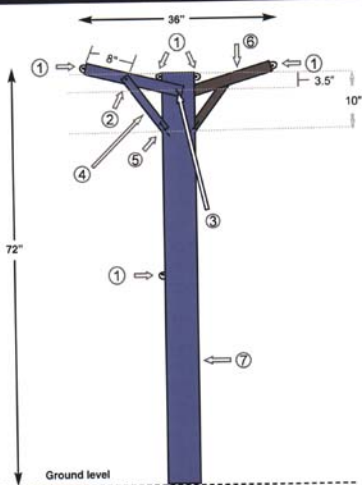

Fig. 13 – A vine with modified Munson training. Shoots have been positioned and the collapsible cross arms raised into their support positions.

Figure 14



LEGEND

- 1 = staple holding trellis wire
- 2 = 3" x 3/8" bolt
- 3 = 4" pole barn nail in 3/8" pre-drilled hole, 1" from end
- 4 = 12" x 3/8" conduit with 3/8" hole pre-drilled at one end
- 5 = 3" sixteenpenny nail
- 6 = 2" x 2" x 19" lumber
- 7 = 8" post, 2" in ground

Fig. 14 – The materials and dimensions for constructing collapsible cross arms for the modified Munson training system.



Section III - Cultural Practices for Managing Mature Grapevines

Modified 4-Arm Kniffin — Growers who do not wish to construct trellis cross arms for the modified Munson training system can obtain many of the benefits of that system by utilizing a more simple two-dimensional training system called 4-arm Kniffin. William Kniffin developed this training system for grapevines in the Hudson Valley region of New York in the 1850s. He utilized four long fruiting canes for each vine. These canes were tied to two trellis wires at varying heights on the trellis (Fig. 3a). In later years, as vines developed a larger size due to improved cultural practices, the fruit along the lower fruiting wire of vines with 4-arm Kniffin training did not develop or mature as well as that situated along the top wire. Therefore, the modified version of Kniffin's training system recommended here places all four fruiting canes on two wires at the top of the trellis (Fig. 3b). This training system, like modified Munson, requires shoot positioning to ensure good fruit maturation (Fig. 3c) and the development of fruitful canes.

Hudson River Umbrella — Growers are urged to use either modified Munson or modified 4-arm Kniffin for table grape production in temperate climates because the effort required to prune out and tie long canes each year with these training systems will be rewarded in fruit quality. However, a grower who seldom experiences winter injury to vines and wants to minimize spring vineyard chores should use Hudson River umbrella (HRU) training for table grape production. HRU is suited for table grape production because it places fruit relatively high on the trellis and is compatible with shoot positioning. Moreover, HRU requires low vine maintenance each spring because vines are semi-permanently attached to a simple, two-dimensional trellis (Fig. 1f).

To establish HRU training, grow vines using standard vine establishment procedures for the first two years (Figs. 8, 9, 10). When pruning for the third growing season, choose a cane high on the trellis that can be pruned and then wrapped gently around the top wire. This will become a cordon. Avoid using a cane if it has been girdled by the twine used to tie the vine to the trellis (Figs. 1a and 1b). Prune the cane long enough to

reach the top wire and then extend to the end of the vine space (Fig. 1d). If the vine has two trunks, repeat this process with the second trunk to establish a cordon on the other half of the vine space (Fig. 1d). When growing single-trunked vines, use a second cane on the same trunk to establish a cordon on the other half of the vine space. After the canes for the cordons have been pruned, prune a renewal spur below each of those canes (Fig. 1d). This is insurance in case shoots don't develop well on the canes you've just chosen for cordons so that it becomes necessary to reestablish the cordon again the following year. When managing double-trunked vines, the most useful renewal spurs are those that will develop shoot growth away from the middle of the vine (Fig. 1d). After canes for cordons and renewal spurs have been selected, remove all other canes from the vine (Fig. 1d). When tying the vine in the spring, start with a loose loop of twine around both canes and the top wire (Figs. 1d and 3d). Then wrap one cane around the top wire so there is one revolution every 18 inches. Tie the end of the cane tight to the wire (Fig. 1d). Loose fitting ties can be used to keep the cane in contact with the rest of the wire. Repeat these steps for the second cane on the other half of the vine space.

Position shoots during the third growing season (see section on shoot positioning) so they hang vertically from the cordon (Fig. 1e). Prune fruiting canes the following winter so they are spaced along the cordon (Fig. 1f). Prune canes long enough to reach the lower wire; this will often require 7 to 10 nodes per cane. Canes that hang vertically will not require tying. Those that run horizontally should be tied to the lower wire (Fig. 1f). Prune canes along the cordon that are not needed for fruiting to renewal spurs (Fig. 1f). Shoots from these renewal spurs will be the source of future fruiting canes.

Maintain trunks and cordons on hardy vines for 10 to 12 years. Then renew trunks from suckers (Fig. 4). The complete process of renewing a vine trained to HRU takes about three growing seasons.

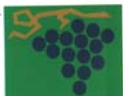

Section III - Cultural Practices for Managing Mature Grapevines

Fan Training — Homeowners or hobby farmers may attempt table grape production on sites not really suited for this purpose. In these situations, low winter temperatures may cause vines to be killed to the snow line or the ground. The best advice for this condition is to cease efforts at grape production or at least to seek hardier, more reliable varieties. Nevertheless, for those with persistence and determination, it is often possible to overwinter even cold-tender grape varieties in a harsh winter climate by employing special strategies, including the use of the fan training system.

The advantage of the fan training system on marginal vineyard sites is that no permanent parts of the vine are required. Multiple trunks are spread (fanned) out from the base of the vine (Fig. 4), and a generous application of renewal spurs near the ground makes frequent trunk renewal possible (Fig. 4). In the fall as soon as vines are fully dormant, a portion or the whole vine is freed from the trellis and laid on the ground. Various objects, from rocks to landscape staples, have been used to put as much of the vine in contact with the ground as possible. If the location experiences reliable snow cover, snow alone may insulate vine tissues from winter low temperatures. Other protective measures — including covering vine tissues with soil, straw, leaves, etc. — may be used to protect vine tissue from cold. In the spring before ground heat can cause the buds to swell, vines are pulled out of the mulch and pruned to create two to four trunks, each with a fruiting cane. They are fanned out and tied within the vine space (Fig. 4). This is a vine training system for vine survival on marginal grape growing sites.

Arbor Training — Grapevines are an attractive landscaping opportunity for homeowners when they are properly managed. Unfortunately, many homeowners grow grapevines so they look like a sprawling weed along a fence. For those willing to make the effort, grapevines on an arbor are an unusual and rewarding variation in horticultural landscaping. Growing grapevines on an arbor can provide luscious, juicy grapes on big, full clusters within easy reach as well as a pleasantly shaded area on a hot summer day (Fig.

15). The grape varieties chosen for an arbor should be hardy and vigorous so growth high on the arbor can be easily maintained for several years. Plans and a materials list are available (Zabadal and Brunke, 2001) to build a highly functional 10-foot-square arbor from readily available materials (Fig. 16). Vines are planted in each corner of this arbor (Fig. 17) so the entire area under the arbor is available for a picnic table, glider, etc. Trunks of these vines are trained to the top of the arbor and then a short cordon is established (Fig. 16c). Two fruiting canes from each cordon will keep fruiting canes at least 15 inches from the edge of the arbor so all clusters hang down through the grid of the arbor. Pruning vines severely to two canes and thinning clusters (Fig. 16c) will ensure both vigorous shoot growth to cover the arbor and showy, well filled clusters. Four vines should be planted when developing the arbor because the grass sod (lawn) that is likely to surround the arbor will often depress the size of vines. If the growth from these four vines becomes excessive so that multiple layers of unmanageable leaves pile up on top of the arbor, remove one or more of the vines and redistribute the growth of the remaining vines. Vines on an arbor should be pruned every year to promote quality fruit production. Though this task may be

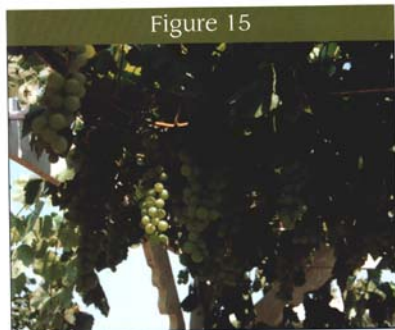
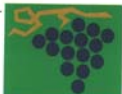

Fig. 15 — 'Marquis' grapes grown on an arbor.



Section III – Cultural Practices for Managing Mature Grapevines

Figure 16

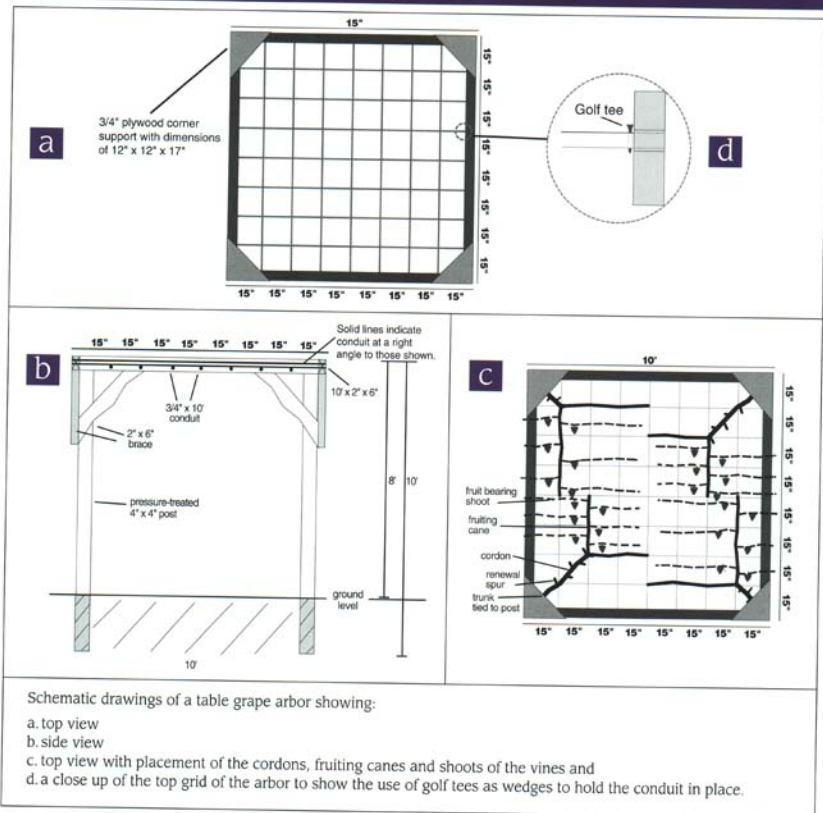
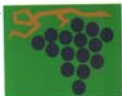

Fig. 16 – Schematic drawings of a table grape arbor showing: (a) top view; (b) side view; (c) top view with placement of the cordons, fruiting canes and shoots of the vines; and (d) a close-up of the top grid of the arbor to show the use of golf tees as wedges to hold the conduit in place.





Section III - Cultural Practices for Managing Mature Grapevines

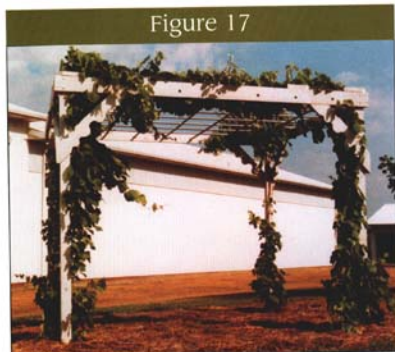

Fig. 17 – A 10-foot-square arbor for table grape production. 'Marquis' grapevines were planted in each corner and are nearing the end of their first growing season. This design can be constructed from readily available materials.

difficult when working below the arbor, the recommended arbor design (Fig. 16) has a unique feature to make pruning easier. The conduits forming the grid of the arbor can be removed by tapping out the golf tees that hold them in place (Fig. 16d). When pruning vines on this arbor in the spring, two or three conduits are removed from the arbor. Then pruning and tying can be performed while standing on a stepladder and looking down at the top of the arbor.

Pruning Vines for Table Grape Production

Pruning is the removal of unwanted parts of a vine. A manageable growth form of a vine is the most visible result of pruning, but the most important reason for pruning is to control crop level. Unpruned vines will at first overbear to produce large crops of poor quality fruit. Vines left unpruned for several years develop alternating cycles of large and small crops. New grape growers often fear that pruning will injure a

grapevine. The reverse is true. The more severely a vine is pruned, the smaller the crop that will develop. That reduces the stress on a vine to ripen the crop so that the vine grows more vigorously. Even a poor job of pruning maintains a vine's health better than no pruning.

Pruning is performed all winter in many large commercial vineyards because this big job requires many hours. Spring is the ideal time to prune temperate-climate vineyards, however, because the extent of winter injury to vines can be determined. If injury has occurred, pruning severity can be adjusted. If winter injury to vines is suspected, evaluate the extent of that injury before beginning to prune vines in the spring. Cut a cross-section of about 10 nodes on canes that are the same quality as those that will be chosen for fruiting. If three or more of those nodes have dead primary buds, as indicated by their dark color (Fig. 2b), then more thoroughly investigate node mortality. Collect 10 canes with 10 nodes each and cross-section those 100 nodes. Prune vines according to the primary bud mortality found as follows: 0 to 15% mortality — prune vines as usual; 20 to 50% mortality — add additional fruiting canes to compensate for the percentage of dead primary buds found; greater than 50% mortality — prune out only unmanageable growth at the bases of vines; delay pruning until after bud break to determine which buds are still alive, then perform a light pruning to retain the desired number of live nodes.

Shoots are easily damaged or even detached from vines as they begin to grow. Under normal circumstances, pruning, trellis repair and tying of vines should be completed before vines begin to grow. In two situations, however, pruning should be delayed until after shoot growth has begun. One, as just mentioned, is after severe winter injury. The other is if vines are planted in a location highly susceptible to spring freezes. When nodes open to expose the first leaves on shoots, winter hardiness is lost and vines become susceptible to spring freeze injury. Unpruned grapevines experience bud break more slowly than pruned vines. Therefore, when vines have been plant-

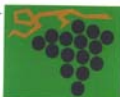

Section III - Cultural Practices for Managing Mature Grapevines

ed in a location vulnerable to frequent spring freeze injury, leaving them unpruned until after shoots have begun to grow gives a several-day advantage in maintaining vine hardiness. Pruning during the early stages of vine growth often causes bleeding of sap from pruning wounds. Contrary to folklore, this is not harmful.

Pruning Severity

Approximately 85 to 90% of the previous season's growth should typically be pruned from a grapevine. This may seem drastic for those unaccustomed to this task, but such pruning is especially important for the table grape grower. If too many fruiting buds are left on the vine, it will produce numerous small, unattractive clusters.

Pruning formulas guide commercial pruning practices by relating the size of a vine to the crop level it can ripen. In this process, canes pruned from a vine are weighed. The weight of the canes is an estimate of a vine's ability to develop the leaf surface area needed to ripen a crop. The amount of useful leaf area that can be displayed by a vine space is limited because only the outer one or two layers of leaves on a grapevine are functional. Therefore, there is a corresponding upper limit for the number of fruiting buds that should be left on the vine after pruning to fill its vine space, regardless of how large the vine grew the previous year.

The main priority of pruning is to keep the appropriate amount of fruiting potential on the vine to produce this year's crop. The more fruiting nodes (buds) saved on a vine, the greater the crop potential. Too much crop, however, will result in poor fruit quality. In commercial practice, the weight of cane prunings on a vine is related by a formula to the number of fruiting nodes retained on the vine. To avoid the complexity of pruning formulas and the need to weigh the canes, the following guidelines for vine pruning severity are made for table grape production in a temperate climate. They are based on visual estimates of vine size. It is assumed that vines are spaced 7 to 8 feet apart.

- 1. VERY SMALL VINES: Description** — Vines fill one-third or less of their vine spaces with growth by the end of the growing season. Mature canes seldom exceed 6 feet in length and often may be 2 feet or less. If all cane prunings were weighed, they would be less than 1 pound.

Recommendation — Retain 15 nodes on the vine. When shoots average 12 inches in length, defruit the entire vine to promote vine growth so it can bear larger crops in future years.

- 2. SMALL VINES: Description** — Vines fill approximately half of their vine spaces with growth by the end of the growing season. If all cane prunings were weighed, they would total 1 to 1.5 pounds.

Recommendation — Retain 20 to 25 nodes on the vine. When shoot growth averages 12 inches in length, retain a maximum of one cluster per shoot on 15 shoots. Remove all other clusters. This allows some cropping while promoting vine growth for larger crops in future years.

- 3. MEDIUM VINES: Description** — Vines fill about three-fourths of their vine spaces with growth by the end of the growing season. If all cane prunings were weighed, they would total 1.75 to 2.5 pounds.

Recommendation — Retain a maximum of 30 to 35 nodes on the vine.

- 4. LARGE VINES: Description** — Vines completely fill their vine spaces with growth by the end of the growing season. If all cane prunings were weighed, they would total 2.75 pounds or more.

Recommendation — Retain a maximum of 40 to 50 nodes on the vine.

Adjust these guidelines as you gain experience. For example, if you left 30 fruiting nodes on a vine and the crop ripened well and some canes grew very long, then you should retain more than 30 nodes on the vine the following year. On the other hand, if the fruit did not mature well, shoots were relatively short, or both, then leave fewer than 30 nodes on the vine the following year. Never exceed 50 nodes per vine for vines producing table grapes. If you leave 50 nodes on

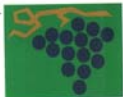

Section III – Cultural Practices for Managing Mature Grapevines

a vine and the vine still grows excessively, reduce vine stimulation by reducing or eliminating fertilizer and/or by establishing a sodded vineyard row middle.

Manage crop size on medium to large vines through a combination of dormant pruning and adjustment of the number of clusters per vine during the growing season. Crop adjustment strategies are discussed later.

Selecting Fruiting Canes

The length of fruiting canes saved on a vine is influenced by the choice of a vine training system. They should be long enough to be conveniently tied to the trellis. The use of 8-, 10- or 12-node canes is common (Fig. 13). When a cane length with a specific number of nodes per cane has been chosen, use this cane length consistently to prune all the vines in a specific vineyard. For example, a medium-sized vine requires 30 to 35 nodes (see pruning severity). It could be pruned to four canes with eight nodes each (Fig. 13).

A quality fruiting cane has a bright, shiny appearance; ranges in color from straw yellow to dark brown, depending on the variety; and has the diameter of a pencil or slightly larger. At times a pruner is forced to use large-diameter canes with lateral canes branching from them. The nodes on lateral canes are highly fruitful; the nodes on a primary cane at the base of a lateral cane are poorly developed and often winter-kill easily. Therefore, large-diameter canes will be satisfactory for fruiting as long as the lateral canes are pruned to one- or two-node spurs whenever they occur (Fig. 1f).

Choose fruiting canes in about equal numbers on each side of a vine space so the fruit is distributed well within the vine space. When tying canes to the trellis, do not cross canes over from one side of the vine to the other. This creates congested growth. For example, when using a modified 4-arm Kniffin training system (Fig. 3b), place two fruiting canes on each side of the vine space. Select canes so they originate and are tied on the same side of the vine. When vines are double-trunked, fruiting canes for each side of the vine

space should arise from the respective trunk on that side (Fig. 3b). A useful way to remember the important aspects of grapevine pruning was devised by Trenholm Jordan, former Extension viticulturist in New York. He used the letters QND: choose **Quality** canes as indicated by good color and diameter; choose the correct **Number** of canes in relation to the size of the vine (see the section on pruning severity); and **Distribute** canes well within the vine space (see the section on vine training systems).

Before pruning can begin, you must decide on the vine training system to be used. With that knowledge, pruning can begin.

Steps in Pruning

Step 1 — Determine the Vine Structure

Familiarize yourself with the structure of the vines to be pruned. Envision the training system to be used. Identify the renewal zone from which fruiting canes will be chosen. Examine the quality of canes to determine what length of healthy, mature canes are available. Have the canes ripened so canes with 10 to 12 nodes might be used? Poorly ripened canes may force you to use canes only six to eight nodes long. Consider how canes will be tied to the trellis. For example, if 30 to 35 nodes were needed for a medium-sized vine, four 8-node canes (Fig. 13) may be more manageable for tying and might give better distribution in the vine space than three 10-node canes. Decide the typical cane length to be used and then vary from that length only when forced to do so by a specific vine condition. Now prune a vine as follows:

Step 2 — Determine Pruning Severity

Stand back 2 to 4 feet from the vine. Estimate the size of the vine as very small, small, medium or large, and accordingly plan to retain 15, 20 to 25, 30 to 35 or 40 to 50 nodes on the vine. For example, a medium-sized vine would require 30 to 35 nodes.

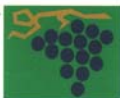

Section III - Cultural Practices for Managing Mature Grapevines

Step 3 — Determine the Need for New Trunk Renewals

Look at the number, age and condition of the trunks of the vine. If a new trunk is needed and a trunk renewal cane is available at the base of the vine, immediately prune it and count it as one of the fruiting canes.

Prune this cane for a trunk renewal as long as possible up to about 4 inches below the top wire of the trellis. Make sure the node at the end of the trunk renewal cane is alive as indicated by green color at the pruning cut at the end of the cane. Trunk renewal canes often are not needed on young vines. Therefore, canes arising from suckers at the bases of young vines can often be pruned from the vine.

Step 4 — Manage Existing Trunk Renewals

Inspect the vine to determine if a trunk renewal cane had been saved the previous pruning period. If so, try to use a cane near the top of this trunk renewal to replace a cordon, if the chosen training system uses cordons, or as a fruiting cane. If there is only weak cane growth on this trunk renewal, retain two or three two-node spurs near the top of the trunk renewal to promote strong cane development for next year. If that isn't possible, prune out this trunk renewal completely. If the total number of desired fruiting canes for the vine can be located on the trunk renewal, prune out the old trunk(s) to keep the vine structure simple. However, don't be in a rush to prune out old trunk(s) if they are still needed as a source of fruiting canes.

Step 5 — Select and Prune Fruiting Canes

The steps above for managing trunk renewals are not a factor when pruning most vines. Therefore, pruning will often go from Step 2 directly to this step. Nevertheless, when trunk renewal is required on a vine, it is attended to before the following regular steps in pruning.

Focus on the renewal zone of the vine. Select a quality cane in a desired location within the renewal zone and immediately prune it to the desired length.

Begin to prune the cane at its base. With your free hand, move outward along the cane while counting the nodes as your hand passes by them. Cut any tendrils causing attachment to other parts of the vine or the trellis. When the desired number of nodes has been counted, make a pruning cut about 3/4 inch beyond the last-counted node to complete the pruning of that fruiting cane. Repeat this process by choosing other quality canes in the renewal zone so they promote good distribution of fruiting canes in the vine space. For example, when utilizing Hudson River umbrella training, good distribution of fruiting canes may mean choosing every second or third cane along the cordon (Fig. 1f). The modified 4-arm Kniffin and modified Munson training systems have centrally located renewal zones (Fig. 3b and Fig. 13). Choose and immediately prune two canes from this renewal zone for each half of the vine space.

Step 6 — Create Renewal Spurs

Renewal spurs create future quality canes in the renewal zone. They are selected after all the desired fruiting canes for this year's crop have been chosen and pruned. For training systems with a central renewal zone (Fig. 3b and Fig. 13), renewal spurs are generally selected below and more central to the vine than the fruiting canes. Some vines may have several high quality canes in a renewal zone but no poor quality canes below them that can be pruned to a renewal spur. In such instances, choose quality canes farther out on the vine for long fruiting canes, and use the more centrally located quality canes for renewal spurs.

Renewal spurs should be created between the longer fruiting canes on vines managed with a cordon (Fig. 1f) so that barren gaps don't develop along the cordon. After the renewal spurs have been selected and pruned, portions of the vine not needed to support those fruiting canes and renewal spurs should be pruned from the vine. This may include not only unused canes but also entire arms and possibly trunks.

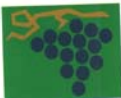

Section III – Cultural Practices for Managing Mature Grapevines

- Begin disease prevention early. Many grape diseases infect vines at early stages of vine growth. Though early-season infections are barely noticeable, they are critically important because they are the source of disease spores for later infections. Therefore, begin a preventive spray fungicide program when grape shoots are 4 to 6 inches long.
- Use spray intervals of 10 to 14 days. Many fungicides control grape diseases for only a 7- to 14-day period.
- Have good fungicide coverage on vines preceding rainy periods. Most grape diseases infect vine tissues during rainy periods, and many fungicides must be present on grapevine tissues prior to rainfall to prevent infection.
- Always apply a disease prevention spray at the start of grape bloom — berry tissues are highly susceptible to infection at this time (Fig. 18).
- Apply a fungicide spray when 90% of the florets are open (Fig. 19) or no more than seven days after the spray applied at the start of bloom, whichever comes first. As the “caps” fall off the individual flowers (florets) on the grape cluster, the tissues that will become the grape berry are exposed and directly vulnerable to infection for the first time. This spray is the first opportunity to get fungicide protection directly on those tissues.
- Choose pesticide materials for sprays after bloom that minimize visible residues. Many pesticide formulations include non-active ingredients to help distribute the pesticide on vine tissues. Though these materials present no health risk, they often create objectionable visible residues long after the pesticide itself has weathered from the vine. Avoid wettable powder formulations after bloom. Use fungicides that are applied at rates of ounces rather than pounds per acre. Use liquid formulations of insecticides. Because the risk of visible residues on fruit severely limits a spray program on table grapes after bloom, a strong early-season preventive fungicide spray program is especially important for table grape production.



Fig. 18 – Early bloom stage of cluster development when a small percentage of the florets on the cluster have opened.

Controlling Animal Depredation in Table Grapes

It can be very frustrating to bring a wonderful table grape crop through its stages of development and then lose it to “critters” at the moment of harvest. Birds and raccoons are often the culprits, but skunks or deer can also be a problem. Control measures for these problems range from slightly to totally effective and inexpensive to costly.

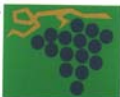

Section III - Cultural Practices for Managing Mature Grapevines

Figure 19



Fig. 19 - A cluster in full bloom (on the right) and a cluster that has not begun to bloom (on the left).

Control of birds begins with the location of the vineyard and its surroundings. Vineyards close to roosting sites for birds such as trees or high-tension wires attract bird problems. Scare devices such as snake and hawk decoys, colored streamers, shiny aluminum pans and scarecrows can be partially effective. Some audio devices scare birds at first, but they can become conditioned to these. Relatively new devices that play distress calls of specific bird species have had encouraging results. Unfortunately, bird pecks on a few berries may destroy the worth of an entire cluster of table grapes. The only foolproof way to control heavy bird depredation pressure is netting. Netting should

extend all the way to the ground. This is often cost prohibitive.

Raccoon depredation can be especially frustrating when these midnight marauders harvest the crop the day before you intended to do so. For those who find it cost effective, a two-wire electric fence system is highly successful in combating this problem. Specialized high voltage/low amperage fence charging units can be used. Some are kept charged with a solar panel. Signs can help avoid human contact with the fence, and the charger can be put on a timer so the wires are charged only at night. Clear a strip of vegetation 2 to 3 feet wide around the vineyard with herbicides and/or mowing. Establish the fence with two wires at heights of 6 and 12 inches above the ground (Fig. 20). Raccoons can't jump! They will crawl either over or under this low fence. In either case, a shocking experience is assured. If you anticipate raccoon problems, set up fencing at the early stages of fruit ripening. Live trapping and relocation has also been used effectively to control this problem. Deer occasionally munch on table grapes. Consult your Extension agent for current recommendations on deer control.

Figure 20



Fig. 20 - A two-wire electric fence with wires at 6 and 12 inches above the ground for controlling raccoon depredation of table grapes.

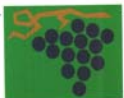

Section IV - Special Practices to Produce Quality Table Grapes

Any grapes that pass the taste test are often considered acceptable fruit quality by backyard growers. Commercial growers must use a more complex consumer definition of acceptable fruit quality that involves not only taste but also appearance, including compactness of the cluster, berry color, berry size, and freedom from visible defects such as cracking, rot and spray residue.

Numerous vine practices can influence these aspects of table grape quality (Table 2). Grape growers must decide how important individual fruit quality components are to their fruit production and marketing. For example, if berry size is considered important, the grower should use one or more of the vine cultural practices that influence berry size (Table 2). Grape varieties vary greatly in their response to cultural practices. Some table grape varieties for temperate climates have been extensively evaluated with regard to these practices and information to guide growers is available (Zabadal et al., 1997). Many table grape varieties, however, have never been evaluated for their response to cultural practices such as trunk or cane girdling. The results might be dazzling or disastrous.

The purpose of the information presented below is to guide table grape growers in their selection and use of special cultural practices for table grapes. The prospects are good that some backyard viticulturists will undertake totally new combinations of these cultural practices on varieties that have never been manipulated in this way before. Viticultural frontiers await. Apply treatments first on a small trial basis and expand your successes. The following vine practices are presented from those most to least commonly used.

Table 2. Four aspects of table grape quality and the cultural practices that may influence them.

Aspects of table grape quality	Cultural practices to influence grape quality
Promote fruit maturity	<ul style="list-style-type: none">• Choice of training system• Increased pruning severity• Shoot positioning• Crop adjustment
Reduce cluster compactness	<ul style="list-style-type: none">• Cluster thinning• Gibberellic acid sprays• Brushing
Increase cluster compactness	<ul style="list-style-type: none">• Increased pruning severity• Flower cluster thinning• Girdling prior to bloom• Shoot topping• Berry thinning
Increase berry size	<ul style="list-style-type: none">• Flower cluster thinning• Berry thinning• Girdling at fruit set• Gibberellic acid sprays• Brushing

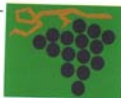

Section IV - Special Practices to Produce Quality Table Grapes

Crop Adjustment

Pruning a dormant grapevine is the principal method for controlling the size of its crop. However, even when the same vine is pruned identically each year, its crop level will vary considerably from year to year. This variability occurs because the weather during both the previous and the current growing seasons greatly influences the number of shoots that develop per node, the number of clusters that develop on each shoot, the number of florets that develop on each cluster, the percentage of those florets that set to become grape berries and berry size development. Therefore, precise control of crop level isn't possible with dormant pruning alone. Because crop level has such a large influence on fruit quality, several crop adjustment strategies are often used in table grape production to achieve a target crop level. Thinning is the practice of adjusting crop level during the growing season. It is achieved in two fundamental ways: altering the number of clusters per vine and altering the size of clusters. How many clusters should be left to ripen on a vine? That simple, reasonable and important question has a complex answer. It depends on the variety being grown, the size of the vine, the use of cultural practices that alter the size of clusters, the desired crop level and year-to-year variations in vine fruitfulness.

To begin sorting out these factors, let it first be stated that quality table grapes can be produced at times in temperate-climate vineyards with yields of 5 tons/acre or higher. However, mediocre fruit quality will often result when such high yields are combined with cooler-than-average growing seasons and/or less-than-optimum vine management. Therefore, commercial growers who apply good cultural practices to their vines should set initial target yields of 4 tons/acre and hobby growers should be content with initial target yields of 3 tons/acre to ensure satisfactory fruit quality (Table 3).

Growers may find with experience that their vines are capable of yields larger than these initial targets as evidenced by the ease with which the crop ripens and the development of large vine size. In such situations,

increasing the target yield will be warranted. Proceed cautiously, however — a large crop of poor quality is an all too familiar cause for destroying a table grape market. With a target yield in mind, the grower must then calculate the number of clusters to be grown on each vine. This will require knowing the number of vines per acre and the average weight of a cluster. The best source of information for average cluster weights is a grower's own several-year record of cluster weights for the specific variety and vine management for a specific vineyard. Naturally, such information is not available at the start of table grape production. Therefore, commercial table grape growers should develop a plan to gather such data. It can be done simply by counting the clusters as they are picked from the vine and placed into a picking lug. Then record the number of clusters on a 3 inch x 5 inch card and put the card in the picking lug. Weigh the lug at the packing shed and record the net fruit weight on the 3 inch x 5 inch card. These data can be permanently recorded after the hustle of harvest and used to calculate an average cluster weight. Doing this for 10 randomly selected vines of each variety each year will provide valuable information for crop adjustment in future years. Each year the multiyear average cluster weight information should be updated.

For most individuals, the initial source of information for crop adjustment of table grapes will be published information. Table 3 lists several temperate-climate table grape varieties, their reported average cluster weights and the number of clusters required for 3-, 4- and 5-ton/acre target yields. Cluster weight information may not be available for a specific variety. Perhaps nursery catalog descriptions or other sources of information on the variety can be used to determine if its clusters are considered small, medium or large. Then use average cluster weights of 0.3, 0.5 or 0.8 pounds, respectively. Data at the bottom of Table 3 indicate the number of clusters required per vine for these three weights of clusters and for three target yields.

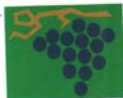

Section IV - Special Practices to Produce Quality Table Grapes

Table 3. Average cluster weight and the number of clusters required per vine to produce yields of 3, 4 or 5 tons per acre for several temperate-climate table grape varieties.

Variety or cluster size	Vine management ¹	Average cluster wt. ² (lb.)	Clusters per vine needed for yields of ³		
			3 tons/acre	4 tons/acre	5 tons/acre
Alden		0.7 ⁴	12	16	20
Buffalo		0.3 ⁴	29	38	48
Canadice		0.6	14	19	24
ES3-22-18		0.4	21	29	36
Einset Seedless		0.3 ⁴	29	38	48
Golden Muscat		0.9 ⁴	10	13	16
Himrod		0.4	21	29	36
Himrod	FCT,GA	0.6	14	19	24
Himrod	FCT,GA,G	0.8	11	14	18
Interlaken Seedless		0.3 ⁴	29	38	48
Lakemont		0.5 ⁴	17	23	29
Lakemont	CT,GA	0.7	12	16	20
Lakemont	CT,GA,G	1.0	9	11	14
Mars		0.4	21	29	36
Marquis		0.6	14	19	24
Marquis	FCT	0.9	10	13	16
Marquis	BT	0.7	12	16	20
New York Muscat		0.3 ⁴	29	38	48
Price		0.3 ⁴	29	38	48
Reliance		0.5	17	23	29
Romulus	CT	0.8	11	14	18
Seneca		0.4 ⁴	21	29	36
Sheridan		0.4 ⁴	21	29	36
Steuben		0.4 ⁴	21	29	36
Vanessa		0.3	29	38	48
Vanessa	FCT,GA	0.4	21	29	36
Vanessa	FCT,G	0.4	21	29	36
Yates		0.5 ⁴	17	23	29
Small clusters		0.3	29	38	48
Medium clusters		0.5	17	23	29
Large clusters		0.8	11	14	18

¹ Fruit grown under natural conditions unless indicated as follows: FCT = flower cluster thin; CT = cluster thin; BT = berry thin; GA = gibberellic acid application; G = girdling.

² Data from the author's research at Benton Harbor, Mich. unless otherwise noted.

³ Assumes typical vine spacings with approximately 700 vines per acre.

⁴ Adapted from Table Grape Varieties for Cool Climates (Reisch et al., 1993).

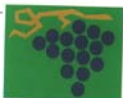

Section IV - Special Practices to Produce Quality Table Grapes

The data in Table 3 will not apply to some table grape vineyards. Calculations for any combination of vineyard dimensions and cluster sizes can be made according to the formula below.

For example, the desired number of clusters per vine for a vineyard with 9-foot row spacing, 7-foot vine spacing, a target yield of 3 tons per acre and medium-sized clusters (0.5 lb.) would be 17 according to the example below.

Lastly, when a grower is unable or unwilling to locate more accurate information for crop adjustment of temperate-climate table grapes, it will be useful to know that vines with typical vine spacings and medium-sized clusters will produce a moderate yield of 4 tons per acre with 24 clusters/vine. Therefore, begin in the first year of production by thinning to 24 clusters per vine. Then, after the first harvest, decide if that number needs to be increased or decreased in subsequent years.

When the desired number of clusters per vine has been determined, situate half of them on each side of the vine space for good fruit distribution. If there are more shoots on a vine than the number of clusters needed, completely defruit some shoots. The leaf area on these fruitless shoots will promote the health of the vine.

It may be appropriate to thin fruit to the desired number of clusters per vine either before or after bloom. It will depend on the variety being grown. The merits of these two basic choices in the time of thinning are presented below.

Flower Cluster Thinning

Flower cluster thinning is performed before the start of bloom. It is most easily accomplished when the shoots average 8 to 12 inches long (Fig. 21) because clusters are highly visible at this stage of growth. The longer shoots grow, the more they will hide clusters. The basal cluster (the cluster closest to the base of the shoot) is typically left on the vine while one or more clusters farther out the shoot are pinched off. Flower cluster thinning will not only reduce crop level but also increase the set of berries for clusters retained on the vine. Therefore, flower cluster thinning is useful for loose-clustered varieties when increased berry set is desirable. However, flower cluster thinning is unsuitable for varieties with naturally compact clusters because it may cause excessive cluster compactness with subsequent berry cracking and fruit rot.

Formula:

$$\text{Desired clusters =} \frac{\text{Target yield (tons/acre)} \times 2,000 \text{ (lb/ton)} \times \text{_____ row spacing (ft)} \times \text{_____ vine spacing (ft)}}{\text{per vine} \quad 43,560 \text{ (ft}^2\text{/acre)} \times \text{_____ average cluster wt (lb)}}$$

Example:

$$\begin{aligned} \text{Desired clusters =} & \frac{3 \text{ (tons/acre)} \times 2,000 \text{ (lb/ton)} \times 9 \text{ (row spacing [ft])} \times 7 \text{ (vine spacing [ft])}}{\text{per vine} \quad 43,560 \text{ (ft}^2\text{/acre)} \times 0.50 \text{ average cluster wt (lb)}} \\ & = \frac{378,000}{21,780} = 17.35 = 17 \text{ clusters/vine} \end{aligned}$$

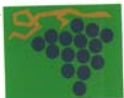

Section IV - Special Practices to Produce Quality Table Grapes

Figure 21



Fig. 21 – Shoots 8 to 12 inches long indicate the optimum time to perform flower cluster thinning.

Cluster Thinning

Many table grape varieties have naturally compact clusters susceptible to berry cracking and fruit rot. In such situations, flower cluster thinning is hazardous. It is best to adjust crop size by thinning clusters after fruit set (Fig. 22). As a generalization, the greater the number of clusters on a vine during bloom, the fewer berries that will set on each cluster. Such reduced fruit set may help to reduce cluster compactness and fruit rot. It may also allow the berries on the clusters room to enlarge without creating excessively compact clusters. Therefore, whenever cluster compactness is a concern, use cluster thinning rather than flower cluster thinning to adjust crop level, even though it is more difficult and more costly.

Unfortunately, there are very few ways vines can be manipulated to reduce cluster compactness (Table 2). Therefore, a labor-intensive variation of cluster thinning may be useful to reduce cluster compactness of a highly desirable variety. This strategy exploits the reduced berry set per cluster that occurs as the number of clusters retained on the vine through bloom is increased. Begin at the time of dormant pruning by retaining an excess number of fruiting canes on the

Figure 22



Fig. 22 – A cluster at the end of fruit set. Berries are slightly smaller than pea-sized. This is the ideal stage of development for berry thinning, cane girdling and/or gibberellic acid sprays to size berries.

vine. Locate these not in the primary fruiting zone but rather lower on the trellis (Fig. 23a). After fruit set, when all berry shatter has occurred, all clusters in this temporary fruiting zone are removed along with any additional clusters that need to be removed from the primary fruiting zone (Fig. 23b).

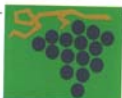

Section IV - Special Practices to Produce Quality Table Grapes

Figure 23

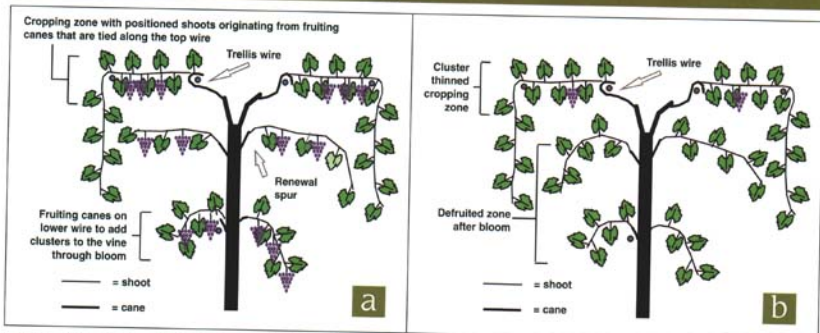

Fig. 23 - A schematic of the cross-section of a vine using modified Munson training (a) before bloom and (b) after bloom when cluster thinning has been performed.

Berry Thinning

Berry thinning is very useful to modify cluster shape when a variety has elongated, straggly clusters. Flower cluster thinning may increase the cluster compactness of long, straggly clusters to produce large, showy clusters. Though these are exciting to grow for the hobby grower, they can be difficult for the commercial grower to harvest and package. Berry thinning produces smaller, globular, more manageable clusters than flower cluster thinning by pinching off the lower portion of the cluster immediately after fruit set (Fig. 22). This increases both cluster compactness and berry size on the remaining portion of the cluster (Fig. 24). Because berry thinning creates smaller, lighter clusters than either flower cluster thinning or cluster thinning, more clusters can be retained on the vine to produce the same size crop (see data for the Marquis variety in Table 3). This practice should be used only on varieties with loose clusters. For example, this practice is not suitable for the tight-clustered variety Canadice, but it gives excellent results when applied to the loose-clustered variety Marquis.

Figure 24



Fig. 24 - A compact, globular cluster of the 'Marquis' variety created by berry thinning, which removed half the length of the cluster rachis.

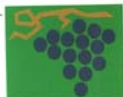

Section IV - Special Practices to Produce Quality Table Grapes

Gibberellic Acid Sprays

Gibberellic acid (GA) is a naturally occurring compound in a group of plant hormones called gibberellins. GA application to table grape clusters may produce several responses. When it is applied to clusters early in their development, it may lengthen the cluster stem (rachis) to reduce cluster compactness. However, this response to GA application is often negated by the natural elongation of the cluster in a later stage of cluster development. Therefore, there is seldom a true cluster-loosening benefit from such early-season GA sprays. Efforts to use GA for this purpose should be evaluated carefully before it is adopted as a standard practice.

Seeds cause an increase in the size of grape berries by producing growth-stimulating hormones including gibberellins. Therefore, seedless grape berries are typically small in their natural condition. GA sprays often dramatically increase the size of seedless grape berries, presumably because they partially substitute for the natural production of gibberellins from seeds.

A spray of GA at midbloom not only may increase berry size but in some varieties can also reduce the number of berries that set per cluster. However, the optimum time for a single application of GA to increase berry size is often at fruit set, when the berries are 4 to 5 mm in diameter (Fig. 22). Commercial applications of GA to increase berry size often involve two or more applications after fruit set, but most of the berry-sizing benefit is obtained by a single application. Trial applications of GA to seedless varieties without a history of GA use should be timed at fruit set (Fig. 22). A concentration of 50 ppm is often effective, but only 25 ppm should be used on 'Vanessa' and as little as 5 ppm is considered optimum for some varieties. Growers will often greatly benefit from the use of GA on many seedless table grape varieties, including 'Himrod', 'Lakemont', 'Vanessa', 'Glenora' and 'Reliance'. Avoid GA use on 'Canadice', 'Mars' and 'Marquis'. Consult the product label for details of application. Sources of GA are listed in Appendix B.

GA applications may also have negative effects on grapevines, including excessive reduction of the number of berries per cluster, the production of grassy or herbaceous flavors in the fruit, a reduction in tissue winter hardiness and a reduction in node fruitfulness. These phytotoxic effects of GA tend to become more pronounced as the seeded condition of the berry increases. Therefore, avoid GA sprays on seeded table grape varieties. Gibberellic acid solutions have been successfully applied to some seeded table grape varieties as a cluster dip. For example, there is significant commercial production of seedless Delaware grapes in Japan. They are produced by individually dipping clusters in a GA solution at bloom. Trials of GA on seeded table grape varieties are more likely to be successful as a cluster dip rather than as a spray.

Girdling

The benefits of girdling grapevines were documented more than 250 years ago through a fortuitous accident. A donkey had been tied to the trunk of a grapevine. It was observed that this vine matured fruit earlier and of higher quality than fruit on surrounding vines. Inspection of the vine revealed that the donkey's rope had worn away the bark and a portion of the trunk just below the bark. Girdling has the same effect by cutting through the phloem tissues below the bark so that the downward (basal) flow of sugars and other compounds produced in the leaves is blocked. Therefore, these substances become deposited in and increase the size of berries and other tissues above the girdle. Girdling is a powerful tool for the table grape grower because it may dramatically increase berry weight and advance fruit maturity, but girdling may also weaken the trunk and root tissues of grapevines in a temperate climate. Experiments a century ago in New York indicated that repeated annual trunk girdling, especially when it was done midseason as the fruit began to ripen, would significantly reduce vine vigor. More recent experiments in a temperate-climate vineyard indicate that vines can tolerate repeated annual trunk girdling when girdling is per-

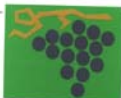

Section IV - Special Practices to Produce Quality Table Grapes

formed at fruit set and when girdling widths do not exceed 1/8 inch. Other girdling variations, including cane and knife girdling, can also be sustainable practices in temperate-climate vineyards.

If girdling is performed at the start of or during bloom, it will promote an increased set of berries as well as increased berry size. Increased berry set is often not desirable because it leads to excess cluster compactness with the prospect of fruit cracking and fruit rot. The berry-sizing benefit of girdling often diminishes the later it is performed after fruit set. Therefore, the optimum time for girdling to increase berry size but not berry set is typically immediately after fruitset when berries are 4 to 6 mm in diameter (Fig. 22).

Three types of grapevine girdling are cane, trunk and knife (a variation of trunk girdling). Cane girdling is easily performed with a specialized tool for this purpose (Fig. 25). A several-year experiment with the Himrod variety indicated that if cane girdles were made between the second and third nodes on canes (Fig. 25) — i.e., so that the two shoots at the base of the cane were below the girdle and were not influenced by it — it was a sustainable practice in a temperate-climate vineyard. The shoots below the girdle are defruited and they become a reliable source of fruiting canes for the next year. After a girdle is made (Fig. 26), plant cells on the edge of this girdling cut



Figure 25

Fig. 25 — A commercial cane girdling tool applied between nodes 2 and 3. The presence of floral parts on the clusters indicates this girdle is being applied somewhat earlier than the ideal time — the end of fruit set.

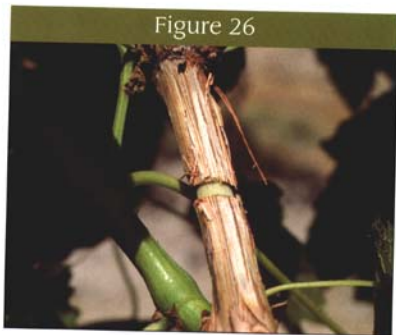
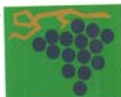

Figure 26

Fig. 26 — A cane girdle with a 1/8-inch wide section of bark and phloem tissues removed.

begin to multiply, and they appear as a whitish mass of tissue called a callus. Over a several-week period, the callus growth on both sides of the girdle cut gradually unite, then phloem conducting tissue redevelops, and ultimately the girdled area becomes as strong and functional as a normal part of the vine. That's the ideal situation (Fig. 27). Unfortunately, complete callusing and repair of the girdle do not always occur. Varieties vary greatly in their response to cane girdling. For example, cane girdles on Himrod and Lakemont callus well, while those on Concord and



Section IV - Special Practices to Produce Quality Table Grapes

Figure 27



Fig. 27 – A cane girdle that has become callused. The larger diameter of the portion of the cane on the left indicates it is beyond the girdle (apical) and increased in size because of the girdle.

Vanessa do not. Moreover, the smaller the diameter of the cane being girdled, the less likely it will callus well. Therefore, cane girdle varieties with an unknown response on a limited scale in the first year. Prune to retain canes with a diameter of about 3/8 inch. Leave renewal spurs. Place the cane girdles so the basal two nodes on each fruiting cane are not influenced by the girdle so there will be a reservoir of healthy canes the following year regardless of how well the cane girdles callus.

Vines almost always callus trunk girdles well. For example, even the varieties Concord and Vanessa, which do not callus cane girdles well, do callus trunk girdles well (Fig. 28). To minimize the risk of long-term stunting of vine size in response to girdling, 1/8-inch-wide trunk girdles are recommended in temperate-climate vineyards.

Knife girdling, a variation of trunk girdling, simply scores a ring entirely around the trunk with a knife cut but without removing any tissue. These cuts quickly and reliably form callus on the Vanessa variety and promote berry size comparable to 1/8-inch-wide trunk girdles. Knife girdling at the Southwest Michigan

Research and Extension Center has been accomplished with a serrated-edge linoleum knife (Fig. 29), which has been considerably easier to use than a trunk girdling tool. When trunk girdling, the exfoliating bark on the trunk should be removed before applying the girdle. More skill is required to use a trunk girdling tool efficiently than a cane girdling tool. A backyard viticulturist can apply a few trial cane (Fig. 26) or trunk girdles with a pocket knife by making two ringing cuts around a cane or trunk about 1/8 inch apart and then removing the ring of tissue between those cuts (Fig. 26). However, if more than a couple of vines are to be girdled, specialized girdling tools make this task easy and fast (Fig. 25). See Appendix B for sources of girdling tools.

Figure 28



Fig. 28 – A well callused trunk girdle on a 'Concord' grapevine.

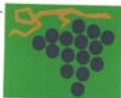

Section IV - Special Practices to Produce Quality Table Grapes

Figure 29

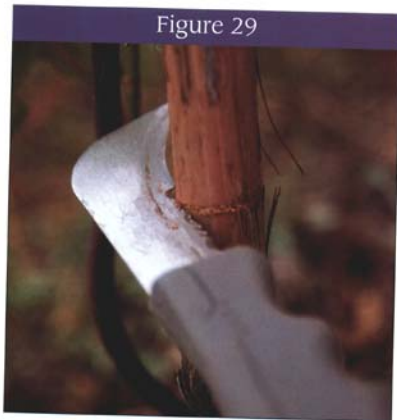
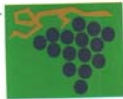

Fig. 29 - A linoleum knife used to make the knife girdle on a 'Vanessa' vine.

Shoot Positioning

Vine canopy management is a key factor in producing quality table grapes in a temperate climate. It begins with the choice of a vine training system. Fan training is presented in this publication only because it is a reasonable option for those determined to grow grapes in a marginal vineyard site that is vulnerable to frequent winter injury to vines. All of the other vine training systems in this publication were chosen because they are compatible with the canopy management practice of shoot positioning. Shoots of grapevines tend to grow upward and then run along the top of a vineyard trellis. In warm climates, the entangled mass of shoot growth at the top of the trellis is often considered desirable because it shades fruit to prevent sunscald. In temperate-climate vineyards, there is less risk of sunscald. The primary challenge is fruit maturation. Fruit exposure to the sun promotes fruit maturation in two ways. First, as the fruit begins to ripen and change color, a time viticulturists call

veraison, the metabolism of acids in the berries is profoundly influenced by the temperature of the fruit. Generally, higher fruit temperatures from exposure to the sun will result in lower acid levels in the fruit. Secondly, when clusters are well exposed to the sun, so are the leaves close to those clusters. That results in more efficient production of sugar in the leaves, which is then transferred to the fruit. The combination of decreased acid and increased sugars is what makes the fruit taste good! Shoot positioning is a vine canopy management tool to achieve the desirable sun exposure of table grapes in a temperate climate. Rather than allowing shoots to pile up in multiple layers in a random arrangement at the top of the trellis, the grower systematically places shoots where they have sunlight-exposed, functional leaves that do not densely shade the fruit. This task is begun early in the growing season, usually about the time of bloom. It is time to begin shoot positioning when shoots have a firm attachment to the cane so they aren't easily detached while being moved, there is only a small amount of tendril attachment to the trellis, and the majority of shoots are long enough and heavy enough to remain in their new orientation — i.e., they don't "spring back" to their original orientation. There is no harm to fruit set if this task is performed during bloom. Shoot positioning table grapes in a temperate climate moves shoots away from the top of the trellis so they hang down on the sides of the trellis, thus exposing the fruit at the top of the trellis. For example, with the modified Munson training system, shoots are moved from a running orientation along the top of the trellis (Fig. 12) so they bend over the outer catch wires and then hang vertically toward the ground (Fig. 13). In that orientation, the clusters as well as the leaves near the clusters are well exposed to sun. The skill to gently break tendril attachments and move shoots off the top of the trellis is easily and quickly learned. If movable arms are used to support the catch wires (Fig. 12), they can be lowered at the time of dormant pruning and then raised again after the first time of shoot positioning. The movable arms make the job of shoot positioning easier. A second time of shoot positioning about two weeks after the first is necessary to



Section IV - Special Practices to Produce Quality Table Grapes

finish orientation of shoots that were too short to manipulate in the first pass. Shoots originating from renewal spurs or other places lower on the vine should also be positioned down and away from the fruit zone (Fig. 1e). This task is most efficiently performed in pairs with one person on each side of the trellis. Prevailing westerly winds often push the majority of shoots to the east side of north-south-oriented trellises. To the extent possible, shoot positioning should counteract that tendency by placing as many shoots on the west side of the trellis as possible. Shoot positioning of vines trained to the Hudson River umbrella (Fig. 1e) and modified 4-arm Kniffin training systems (Fig. 3c) orients shoots vertically down the sides of the trellis.

If a grower is unable to shoot position at the optimum time, it should still be done later. Late shoot positioning has two penalties however. First, the task becomes considerably more difficult. Tendrils may have to be cut rather than simply pulled apart. Secondly, if the fruit develops too long in the shade, it may be vulnerable to sunscald, depending on the variety and the weather conditions.

Shoot positioning not only promotes fruit maturity but also creates a better, more open target for pesticide applications, reduces the susceptibility of the vine to several diseases, facilitates both hand harvesting and pruning the next winter, and promotes the fruitfulness of nodes in the renewal zone for the following growing season. This vineyard task should be a high priority for every grower of table grapes in a temperate climate.

Brushing

Many desirable table grape varieties develop very compact clusters. In a temperate climate, tight clusters combined with a thin berry skin can eliminate the commercial potential of a variety. Rain at harvest can cause tight-clustered varieties to crack and rot very quickly. Therefore, a grower may be forced to pick such fruit before it has adequately ripened. Few options are available to reduce cluster compactness

(Table 2). A gibberellic acid spray, the easiest of these options, is ineffective on many varieties. Brushing can reliably reduce cluster compactness, but this is a labor-intensive practice, and the grower must decide if it is warranted. It may be a great technique on a few vines in a backyard vineyard, but will it pay for itself on commercial acreage? Brushing must be performed prior to the start of bloom — i.e., before the caps come off of the individual florets — to avoid mechanical scarring of berry surfaces. A cluster is held in one hand (Fig. 30) and one or a pair of brushes with coarse plastic teeth are stroked through it several times. A common hairbrush with relatively thick, widely spaced plastic bristles may be used.

Canadice, a red seedless table grape for temperate climates, has several desirable characteristics (Zabada et al., 1997), but it often develops excessively compact clusters that cannot be loosened with gibberellic acid. Brushing Canadice clusters at the Southwest Michigan Research and Extension Center reduced cluster compactness and increased berry size (Fig. 31). A very high percentage of the florets retained on the cluster after brushing will set grape berries so be aggressive when brushing — remove 50% or more of the florets.

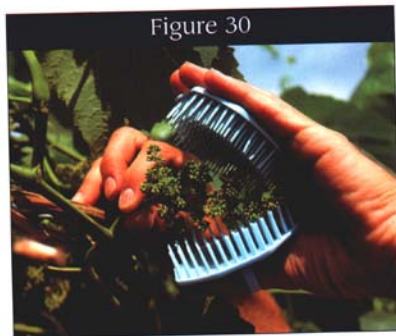
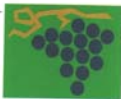

Fig. 30 - Two plastic bristle hairbrushes that are about to be used to remove the majority of florets on this cluster.



Section IV - Special Practices to Produce Quality Table Grapes

Experience will indicate the extent of brushing necessary for a particular variety. It is amazing how a cluster may look very straggly after brushing (Fig. 32) and yet still set a full cluster (Fig. 31).

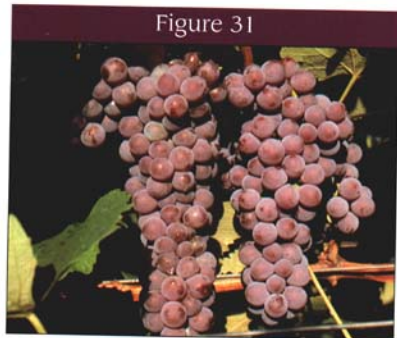

Fig. 31 - Clusters of the 'Canadice' variety that were either brushed (r) or not (l) at early bloom.

Shoot Topping

Too many berries per cluster and excessive cluster compactness are common concerns of table grape growers. Occasionally, however, a grower may desire to increase berry set on straggly, loose clusters. Flower cluster thinning and berry thinning (Table 2) are good strategies for increasing cluster compactness. Shoot topping is another method for increasing fruit set. When grapevines are going through bloom, the clusters and rapidly growing shoots are competing for the sugars and other substances produced in the leaves. Slowing the growth of the shoot diverts more of the substances from the leaves into the clusters to promote an increase in berry set. A temporary reduction in grapevine shoot growth during bloom was accomplished in the past by spraying the product Alar. Shoot topping has the same effect by cutting off the

Figure 32



Fig. 32 - A flower cluster after brushing to remove the majority of its florets.

terminal growth of fruiting shoots at the first sign of bloom. One-third to one-half of the shoot may need to be removed to be effective. Lateral shoots from the nodes at the ends of these cut shoots will eventually grow out to extend the length of the shoots that were topped.

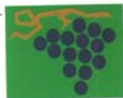

Section V - Harvest, Storage and Marketing of Table Grapes

Harvesting Table Grapes

The balance between sugar and acid in a grape berry determines its palatability. Though the timing of commercial table grape harvests may be guided by measurements of sugar and acid levels in the fruit, often the start of harvest of table grapes will simply be a matter of deciding when the grapes taste good. Grapes do not ripen off the vine, so their quality can only go down after picking. Picking too early may jeopardize your market. Picking too late may cause a loss of early market opportunity and often reduces the storage life of the fruit. It can be helpful to have someone other than the grower taste the grapes to determine the start of harvest.

Develop an organized plan for harvesting. Table grapes are either harvested into field lugs for repacking or picked directly into market packaging. Whatever containers are used, distribute them in the vineyard so they are readily available to pickers. Their time should be totally dedicated to picking. Picking shears should be kept clean and well lubricated. Picking stands, which allow pickers to carefully place clusters in containers without bending over, may be specialized to include built-in weigh scales (Zabadal et al., 1988). Hobbyists may simply use a gardening cart or a little red wagon.

Profitability from growing table grapes is often closely linked to harvesting efficiency. Maintain accessible row middles that are neither muddy from recent cultivations nor unmowed. Train and shoot position vines to expose fruit in structured fruiting zones so pickers don't have to hunt for clusters randomly scattered throughout the trellis. Grow clean, uniformly ripe fruit so the picker can pack a high percentage of quality clusters without time-consuming effort to trim away defects.

Table grape harvesting in warm climates typically begins in the early morning so the fruit is picked as cool as possible. It is then quickly transported to cold storage facilities. Harvesting early in the day is also a good practice in a temperate climate. If the fruit is wet with dew, however, wait until it dries before picking to avoid storage problems.

Storing Table Grapes

Most of the table grape varieties grown in a temperate climate store well in a typical farm cold storage for at least seven to 10 days. With a little effort, that time period may be lengthened. Desiccation and decay are the storage hazards of table grapes. Fumigation, the use of sulfur dioxide pads or other fungicidal techniques combat storage diseases of grapes in large commercial operations (Zabadal et al., 1988). Put only healthy, dry grapes into storage. Pick grapes for storage early in the harvest period when they are acceptably ripe rather than later when they are overripe.

The cluster stem (rachis) is the most vulnerable portion of the cluster to water loss. Browning of cluster stems can occur when clusters have lost as little as 5% of their weight because of desiccation. Some relatively easy steps can reduce fruit desiccation. Harvest fruit as cool as possible and transport it quickly to cold storage. Even under temperate-climate conditions, place containers of harvested grapes into cold storage at frequent intervals through the day. Cooling grapes as soon as possible after picking is very important. One research study indicated that for every hour grapes were held at 90°F after picking, they lost one week of storage life at 32°F (Nelson, 1985). Forced-air cooling is used in large commercial operations to remove the field heat from table grapes quickly. Small

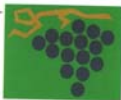

commercial growers can also utilize this technology (Zabadal et al., 1988).

Store table grapes as close to 32°F as possible without exposing them to freezing. High humidity in the cold storage is very desirable. Some storage facilities can maintain 95 to 98% relative humidity. At high relative humidities, the cold storage temperature must be held constant to avoid condensation on the fruit. If grapes can be stored at a relatively constant temperature, then moisture barriers such as polyethylene bags around individual picking lugs or shrink wrapping of pallets with stacked master containers can help reduce desiccation.

Marketing Table Grapes

Flavor and vine-ripened maturity are the marketing strengths of table grapes grown in temperate climates. Be politely assertive when developing a new market for table grapes. Acquaint consumers with the quality of unknown grape varieties by providing free samples. Point-of-sale literature is also helpful. Quality fruit resulting from good vineyard management is fundamental to all marketing success.

Attractive packaging of an appropriate size is important. Avoid large container sizes. Even a 2-quart container with 3 pounds of grapes is often larger than consumers desire. Most table grape varieties grown in temperate climates cannot be packed in bulk boxes and sold by the pound because there is too much waste from berries shattering off clusters. One-quart containers packed in a master container are popular. Perforated polyethylene bags for packaging individual clusters are another possibility.

Temperate-climate table grapes are often direct marketed through roadside or regional farm markets. Grocery store chains will often welcome local specialty crops as a special attraction to their produce department as long as they can be assured of quality and a consistent supply. Table grapes grown in temperate climates are unlikely to compete on the basis of price per unit with warm-climate table grapes. Nevertheless, with the proper choice of varieties, cultural practices and marketing, many people have developed profitable niche markets for this exciting specialty crop.

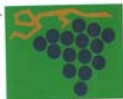

Appendix A - Available Publications

These grape publications may be helpful to table grape growers. Sources of these publications are listed below.

- Bordelon, B.P. 1995. Grape Varieties for Indiana. Bull. HO-221. Lafayette, Ind. Purdue Univ. (Source 6)
- Cahoon, G., M. Ellis, R. Williams and L. Lockshin. 1991. Grapes: Production, Management and Marketing. Bull. 815. Columbus, Ohio: Ohio State University. (Source 2)
- IPM Grape Fact Sheets. Set of 14 on: Eutypa Dieback, Powdery Mildew, Botrytis, Black Rot, Downy Mildew, Phomopsis Grape and Leaf Spot, Berry Moth, Grape Cane Borer, Cutworms, Grape Leafhopper, Grape Cane Girdler, Grape Flea Beetle, Grape Rootworm, Grape Tumid Gallmaker. Extension publication #102FSG. Ithaca, N.Y. Cornell University. (Source 3)
- Jordan, T.D., R.M. Pool, T.J. Zabadal and J.P. Tomkins. 1981. Cultural Practices for Commercial Vineyards. Geneva, N.Y.: Cornell University. (Source 3)
- Pearson, R.C., and A.C. Goheen (eds.). 1988. Compendium of Grape Diseases. St. Paul., Minn.: APS Press. (Source 4)
- Ramsdell, D.C. 1994. Common Grape Diseases of the Grapevine in Michigan. Bull. E-1732. E. Lansing, Mich.: Michigan State University. (Source 5)
- Reisch, B.I., D.V. Peterson, R.M. Pool and M.H. Martens. 1993. Table Grape Varieties for Cool Climates. I.B. Bulletin 234. Ithaca, N.Y.: Cornell Univ. (Source 3)
- Wolf, T.K., and E.B. Poling. 1995. The Mid-Atlantic Winegrape Grower's Guide. Raleigh, N.C.: N. Carolina State Univ. (Source 7)
- Zabadal, T.J. 1997. Vineyard Establishment II - Planting and Early Care of Vineyards. Bull. E-2645. East Lansing, Mich.: Michigan State University. (Source 5)
- Zabadal, T.J. 1999. Pest Control in Small Vineyards. Bull. E-2698. East Lansing, Mich.: Michigan State University. (Source 5)
- Zabadal, T.J., J.A. Bartsch, G.D. Blanpied, T.J. Dennehy, R.C. Pearson, R.M. Pool and B.I. Reisch. 1988. Concord Table Grapes, A Manual for Growers. Geneva, N.Y.: Cornell University. (Source 1)
- Zabadal, T.J., G.S. Howell and D.P. Miller. 1997. Table Grape Varieties for Michigan. Bull. E-2642. East Lansing, Mich.: Michigan State University. (Source 5)
- Zabadal, T.J., and J.A. Andresen. 1997. Vineyard Establishment I - Preplant Decisions. Bull. E-2644. East Lansing, Mich.: Michigan State University. (Source 5)
- Zabadal, T.J. and G. Brunke. 2001. Building a Grape Arbor. SWMREC Special Report #16 (Source 8)

Source 1

Communication Services Distribution
N.Y. State Ag. Expt. Station
Cornell University
Geneva, NY 14456

Source 2

Ohio State University Publications
385 Kottman
2021 Coffey Road
Columbus, OH 43210-1044
You will be billed for the cost of the publication plus shipping.

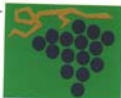

Appendix A - Available Publications

Source 3

Cornell Extension Resource Center - GP
7 Cornell Technology Park
Ithaca, NY 14850
Phone: 607-255-2080
Fax: 607-255-9946
E-mail: DIST-CENTER@CCE.CORNELL.EDU
(Items can be ordered by phone with Visa or MasterCard.)

Source 4

American Phytopathological Society
3340 Pilot Knob Road
St. Paul, MN 55121
(Or order with a credit card at 1-800-328-7560.)

Source 5

Michigan State University Bulletin Office
10-B Agriculture Hall
East Lansing, MI 48824-1039
(Or order with a credit card at 517-355-0240.)

Source 6

Purdue University
Publications Mailing Room
301 South 2nd Street
Lafayette, IN 47905-1092

Source 7

North Carolina State University
Publications Office
Department of Ag Communications
Campus Box 7063
Raleigh, NC 27695-7603

Source 8

The Southwest Michigan Research & Extension
Center website:
www.msue.msu.edu/swmrec

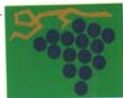

Appendix B - Sources of Materials for Table Grape Production

Forestry Suppliers, Inc., P.O. Box 8397, Jackson, MS
39284-8397 (800-647-5368) - pruning tools, protective clothing, herbicide sprayers, tying materials.

Innovative Fence Systems, 640 East Main St., Palmyra,
NY 14522 (315-597-1111) - pruning tools, trellis materials.

A.M. Leonard, Inc., 241 Fox Dr. P.O. Box 816, Piqua,
OH 45356-0816 (800-543-8955) - tying materials.

J. Mollema & Son, Inc., 5400 36th St., SE, Grand
Rapids, MI 49512 (800-234-GROW) - pruning tools.

Orchard Valley Supply, 734 Main St., Fawn Grove, PA
17321 (717-382-4612) - tying materials, picking shears, cane girdling tool, bird control supplies.

Pioneer Equipment Co., 953 G Street, Reedley, CA
93654 (209-638-9201) - girdling tools.

Spec Trellising, 39 Indian Dr., Ivyland, PA 18974 (800-237-4594) - trellis materials.

Gibberellic acid - Several companies market gibberellic acid. Nevertheless, it may be necessary to special order this material from an agricultural chemical distributor. Several products are available as a 4% solution of gibberellic acid. Growers will find these easier to use than dry formulations. Follow product labels. As a guideline, 5.6 ml or 1.1 tsp of a 4% gibberellic acid solution diluted to a volume of 1 gallon will make a GA solution concentration of 50 ppm.

Company: Agtrol International
Product name: Gibgro 4LS
Internet address: <http://www.agtrol.com>

Click on "sales offices" on the left side of the page to locate names and address of local distributors of this product by clicking on a world map, a U.S. map, a U.S. states map and then a list of locations within your state.

Company: Griffin L.L.C.
Product name: Gibbex 4%
Internet address: www.griffinllc.com/

Click on "Sales/Technical Rep Locator" in left column

Company: Valent USA Corporation (formerly Abbott)
Product name: Progibb 4% PGR
Internet address: www.valent.com

Click on "Agricultural products" and then "distributors" on the left side of page.

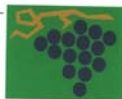

References

- Bordelon, B.P. 1995. Grape Varieties for Indiana. Bull. HO-221. Lafayette, Ind.: Purdue University.
- Cahoon, G., M. Ellis, R. Williams and L. Lockshin. 1991. Grape Production Management and Marketing. Bull. 815. Columbus, Ohio: Ohio State University.
- Eichenlaub, V.L., J.R. Harman, F.V. Nurnberger and H.J. Stolle. 1990. The Climatic Atlas of Michigan. Notre Dame, Ind.: University of Notre Dame Press.
- Ellis, M.A. 1995. Integrated Pest Management (IPM) Disease Management Guidelines for Grapes in Ohio. Wooster, Ohio: Ohio State University, OARDC.
- Gut, L.J., R. Issacs, J. Wise, A.L. Jones, A.M.C. Schilder, B. Zandstra and E. Hanson. 2001 Fruit Spraying Calendar for Commercial Growers. Bull. E-154. E. Lansing, Mich.: Michigan State University.
- Hanson, E. 1996. Fertilizing Fruit Crops. Bull. E-852. E. Lansing, Mich.: Michigan State University.
- Harrell, D.C., and L.E. Williams. 1987. The Influence of Girdling and Gibberellic Acid Application at Fruit Set on 'Ruby Seedless' and 'Thompson Seedless' Grapes. Amer. J. Enol. Viticult. 38:83-88.
- Hofacker, W. 1978. Investigations on the Photosynthesis of Vines: Influence of Defoliation, Topping, Girdling and Removal of Grapes. Vitis 17:10-22.
- Jacob, H.E. 1928. Some Responses of the Seedless Vitis Vinifera to Girdling. Proc. Amer. Soc. Hort. Sci. 25:223-229.
- Jacob, H.E. 1931. Girdling Grapevines. Agricultural Extension Service. Circ. 56:1-18. Davis, Cal.: University of California.
- Jensen, F., D. Luvisi, F. Swanson, G. Leavitt, F.G. Mitchell and G. Mayer. 1976. Effects of Complete and Incomplete Girdles on 'Thompson Seedless' and 'Ribier' Table Grapes. Amer. J. Enol. Viticult. 27:65-67.
- Nelson, K.E. 1985. Harvesting and Handling California Table Grapes for Market. Bull. 1913. Davis, Cal.: University of California.
- Pearson, R.C., and A.C. Goheen (eds.). 1988. Compendium of Grape Diseases. St. Paul, Minn.: APS Press.
- Ramsdell, D.C. 1994. Common Diseases of the Grapevine in Michigan. Bull. E-1732. E. Lansing, Mich.: Michigan State University.
- Reisch, B.I., D.V. Peterson, R.M. Pool and M.H. Martens. 1993. Table Grape Varieties For Cool Climates. I.B. 234. Ithaca, N.Y.: Cornell University.
- Weaver, R.J. 1956. Relation of Time of Girdling to Ripening of Fruit of 'Red Malaga' and 'Ribier' Grapes. Proc. Amer. Soc. Hort. Sci. 65:183-186.
- Winkler, A.J. 1953. Producing Table Grapes of Better Quality. Blue Anchor 30:28-31.
- Winkler, A.J., J.A. Cook, W.M. Kliever and L.A. Lider. 1974. General Viticulture. Berkeley, Calif.: University of California Press.
- Wolf, T.K., and E.B. Poling. 1995. The Mid-Atlantic Wine Grape Grower's Guide. Raleigh, N.C.: North Carolina State University.
- Zabada, T.J. 1986. Seedless Table Grapes. Part 1: New Outlook, Technology, and Varieties. Vineyard and Winery Management. May-June, pp. 24-29.

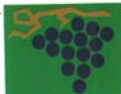

References

- Zabadal, T.J. 1986. Seedless Table Grapes Part II: A Guide to Growing These Profitable Grapes in Cool Climates. *Vineyard and Winery Management*. July-August, pp. 27-32.
- Zabadal, T.J. 1992. Response of 'Himrod' Grapevines to Cane Girdling. *HortScience* 27:975-76.
- Zabadal, T.J. 1997. Vineyard Establishment II - Planting and Early Care of Vineyards. Bull. E-2645. East Lansing, Mich.: Michigan State University.
- Zabadal, T.J. 1999. Pest Control in Small Vineyards. Bull. E-2698. East Lansing, Mich. Michigan State University.
- Zabadal, T.J., J.A. Bartsch, G.D. Blanpied, T.J. Dennehy, R.C. Pearson, R.M. Pool and B.I. Reisch. 1988. *Concord Table Grapes: A Manual for Growers*. Ithaca, N.Y.: New York Agricultural Experiment Station.
- Zabadal, T.J., and J.A. Andresen. 1997. Vineyard Establishment I - Preplant Decisions. Bull. E-2644, East Lansing, Michigan State University.
- Zabadal, T.J., G.S. Howell and D.P. Miller. 1997. Table Grape Varieties for Michigan. Bull. E-2642, East Lansing, Mich.: Michigan State University.
- Zabadal, T.J. and G. Brunke. 2001. Building a Grape Arbor. SWMREC Special Report #16. Benton Harbor, Mich.: Michigan State University Southwest Michigan Research and Extension Center.

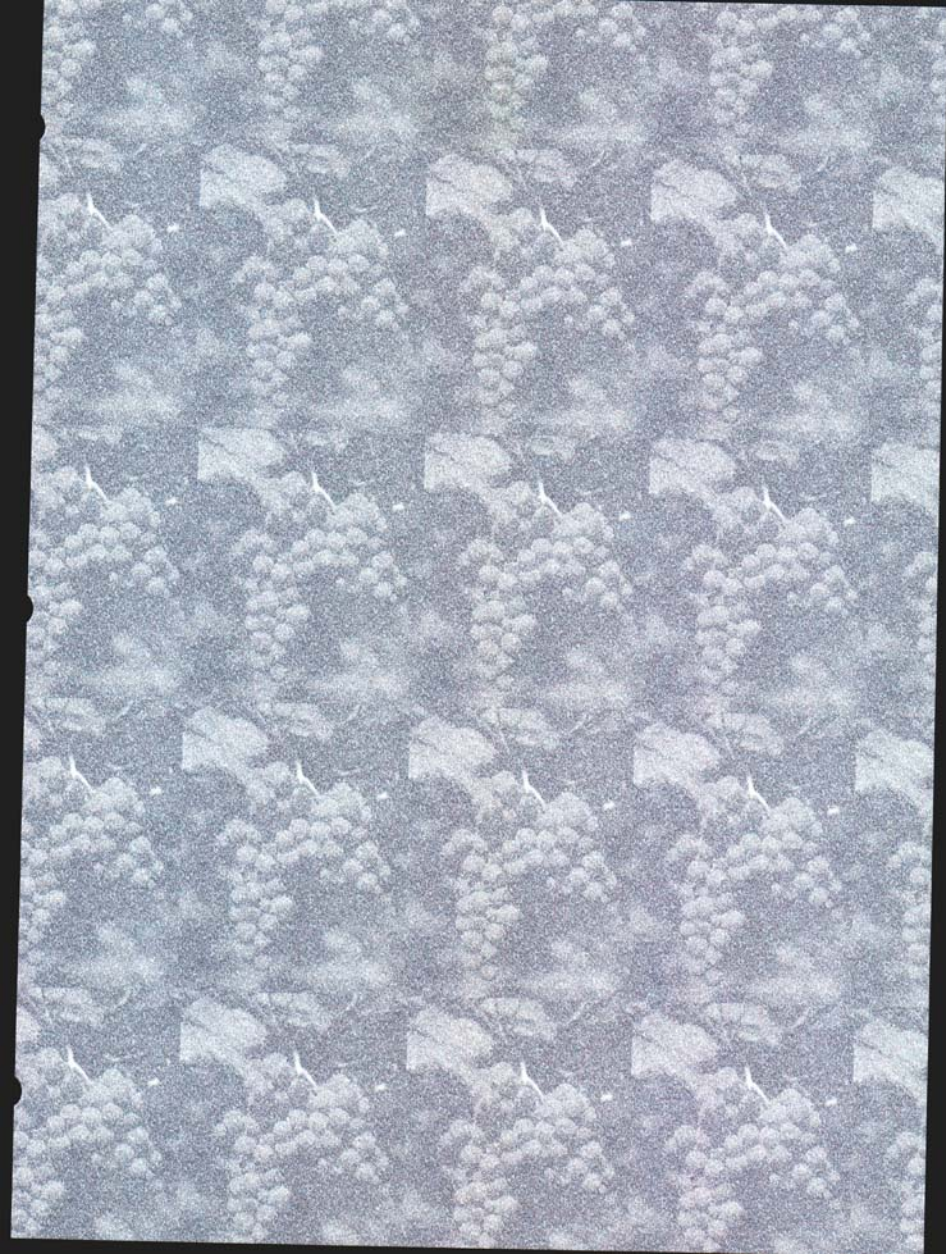



Selecting a Vineyard Site

Other Extension Bulletins in this series:

- E-2642, Table Grape Varieties for Michigan
- E-2643, Wine Grape Varieties for Michigan
- E-2644, Vineyard Establishment I: Preplant Decisions
- E-2645, Vineyard Establishment II: Planting and Early Care
- E-2698, Pest Control in Small Vineyards

For copies of these titles or a catalog of available publications, contact your county Extension office (listed under GOVERNMENT in the white pages of your phone book) or the MSU Bulletin Office, 10-B Agriculture Hall, Michigan State University, East Lansing, MI 48824-1039 (phone: 517-355-0240 or fax: 517-353-7168).

MICHIGAN STATE
UNIVERSITY
EXTENSION

MSU is an affirmative-action, equal-opportunity institution. Michigan State University Extension programs and materials are open to all without regard to race, color, national origin, gender, religion, age, disability, political beliefs, sexual orientation, marital status, or family status.

Issued in furtherance of Extension work in agriculture and home economics, acts of May 8 and June 30, 1914, in cooperation with the U.S. Department of Agriculture. Margaret A. Bethel, Extension director, Michigan State University, E. Lansing, MI 48824.

This information is for educational purposes only. References to commercial products or trade names do not imply endorsement by MSU Extension or bias against those not mentioned. This bulletin becomes public property upon publication and may be printed verbatim with credit to MSU. Reprinting cannot be used to endorse or advertise a commercial product or company.

Produced by ANR Communications.

New 1/02 - 2M - KMF/MB Price \$7.00, for sale only

