

(First Revision) MAY 1946

Improve Your Kitchen Cupboards

By Julia Pond

The mixing cupboard pictured above has the following desirable features:

- 1. There are no useless articles in the cupboard.*
- 2. The most frequently used items are within easy reach.*
- 3. The shelves are spaced to fit the articles to be stored.*
- 4. Removable vertical partitions are provided for cake and pie pans.*
- 5. Racks on doors mean that each spice can, etc., can be located without first moving another article.*
- 6. Hooks under spice racks provide a convenient place for hanging measuring cups and spoons.*

MICHIGAN STATE COLLEGE
EXTENSION SERVICE
EAST LANSING

SPACE SHELVES TO FIT ARTICLES TO BE STORED ON THEM

These extra shelves can be placed in any cupboard. The narrow shelves can be used for storing small articles like cups, glasses, saucers, spices, etc. The triple-deck shelf is an excellent solution for the storage of platters and trays. The shelves can be any length or width desired.

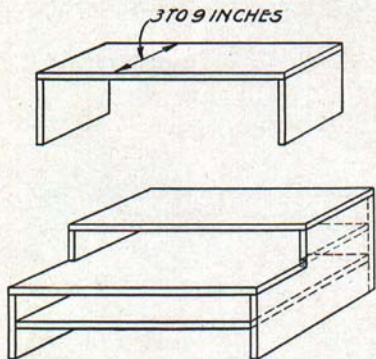

There is no waste space in this dish cupboard. Dishes of the same size and kind are the only ones stacked together. One to two inches of clearance has been allowed, which means that dishes can be easily placed on or removed from shelf. The cups, saucers, etc. are stored on narrow or "half" shelves.





(Left, above) In this cupboard the shelves have been spaced to fit the utensils to be stored. Notice that the top shelves can be pulled out when utensils are placed in or removed from cupboard. This type of shelf is very desirable for the lower cupboard.



(Right, above) The interior of the section of a lower cupboard for storing baking pans. The vertical partitions are removable.

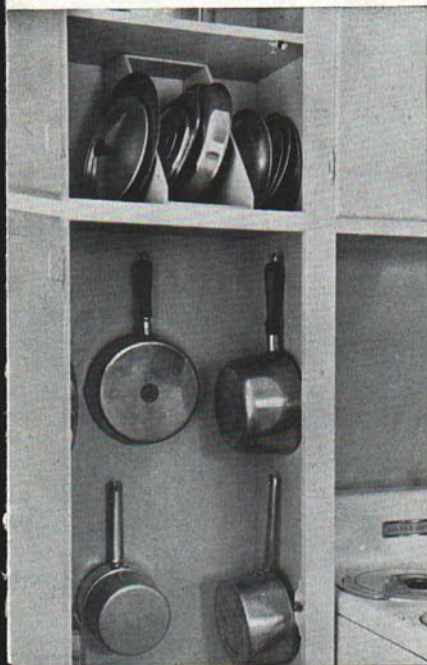

Above is pictured a very simple type of vertical partition. Though it fits rather closely in the cupboard, it can easily be removed when cleaning. If desired, several of these "box-like" partitions might be used on one shelf. One of these partitions has been used on the shelf in the cupboard shown on the left.

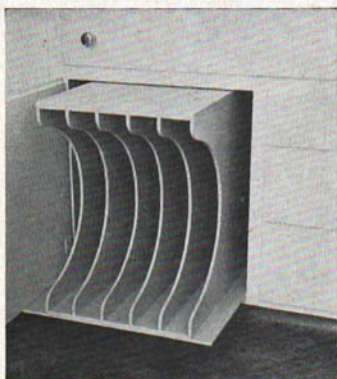
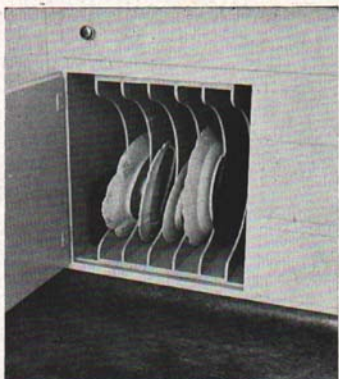

Above are two views of a vertical partition rack which has been constructed to fit exactly the available space. It is, however, removable which makes for ease in cleaning.

Vertical partitions in a drawer (lower left-hand picture) provide for the storage of baking pans for cakes, pies, muffins, and cookies. Depth and width of drawer depend upon size and number of utensils to be stored. It is desirable to make these partitions removable. *Caution*—Do not plan to store too many utensils in a drawer of this type. A large, heavy drawer is difficult to open or close.



Below (lower right-hand picture) is another very easily constructed type of vertical partition rack.



EQUIP SILVER AND CUTLERY DRAWERS WITH PARTITIONS



viding a sliding tray for the silver. Tea towels are stored in the bottom.

Notice the knife racks (lower pictures) which are a part of the removable partitions in this cutlery drawer.

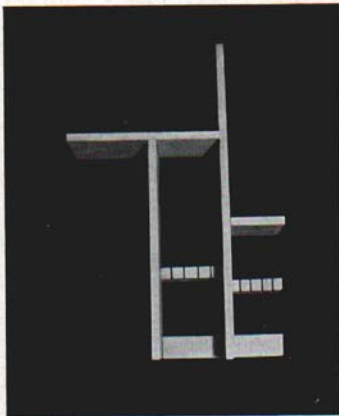
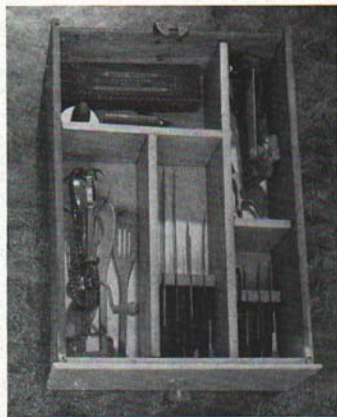

Partitions in drawers for silver, cutlery and other small equipment will mean a more orderly cupboard. The first requirement of such partitions is that they be planned to fit equipment to be stored in the drawer. The second very desirable feature is that the partitions be removable in order to simplify cleaning.

The space in the upper drawer has been made more convenient by pro-

STORE KNIVES AND SPICES IN RACKS

The type of knife rack pictured on the left can be hung on the wall, on the cupboard, or on the inside of cupboard door. It is 4 inches in width and provides space for five knives.

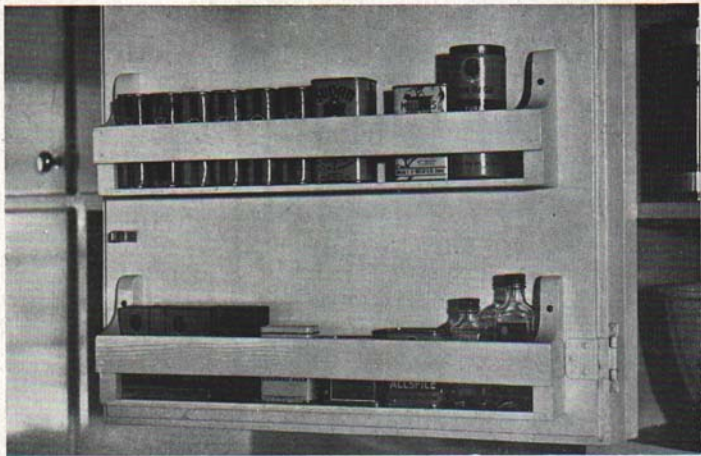

Racks for spices, extracts, etc. can be fastened to most every cupboard door. The length of the rack is determined by width of door. The depth of rack should depend upon the size of cans or items to be stored. The bar or strip across front of rack should be placed about one inch from the bottom and so it does not cover the names on cans.

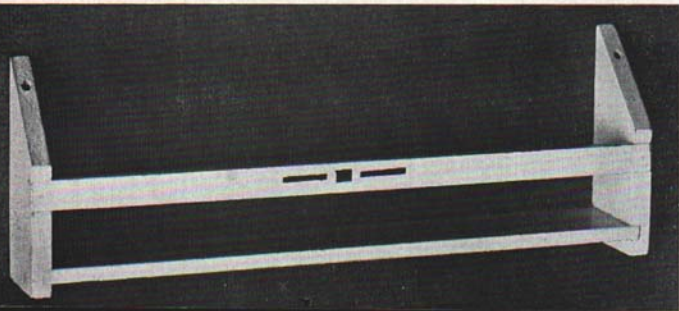



CORRECT WORK HEIGHTS ARE IMPORTANT. THEY REDUCE FATIGUE

The height of work spaces should be adjusted to the height of worker and to type of work to be done. This means that the heights of the sink and the work space of mixing cupboard should not be the same. The work heights for the average (65 inches tall) woman are:

32½ inches from floor
of sink to floor of room;

38½ inches from drain
board to floor; and

32 inches for mixing
table.

The upper picture shows the two heights on the same wall. In the lower picture the change has been made at the corner.





A lap board provides a comfortable place to work when sitting to do certain household jobs. An ordinary chair with a back, can be used instead of a high stool. This permits the worker to place the feet flat on the floor.

The distance from the board to the floor depends upon the size of the homemaker. The usual distance is 25 inches. The board should be wide enough to allow two average size pans to be placed on it.

IMPROVE YOUR KITCHEN CUPBOARDS BY:

1. Discarding useless equipment.
2. Storing frequently used items in most convenient place in cupboard.
3. Spacing shelves to fit articles to be stored on them.
4. Adding vertical partitions or "pigeon holes" for storage of trays, platters, covers and pans for baking pies, cakes and cookies.
5. Adding partitions to cutlery and silver drawers.
6. Providing racks for storage of knives, spices, extracts, etc.
7. Adjusting work heights to worker and type of work to be done.

Michigan State College and U. S. Department of Agriculture cooperating. R. J. Baldwin, Director Extension Service. Printed and distributed under acts of Congress, May 8 and June 30, 1914.

Issued October 1945
First Revision May 1946