

# AIR BLAST ORCHARD SPRAYING

*Nozzle Arrangement  
and Calibration*



Robert Wilkinson  
Professor Emeritus  
Agricultural Engineering Department  
Michigan State University

MICHIGAN STATE  
UNIVERSITY  
EXTENSION



Extension Bulletin E-2712

# **AIR BLAST ORCHARD SPRAYING**

*Nozzle Arrangement and Calibration*

Robert Wilkinson  
Professor Emeritus  
Agricultural Engineering Department  
Michigan State University

MICHIGAN STATE  
UNIVERSITY  
EXTENSION



# Air Blast Orchard Spraying

## Part I. Understanding the Basics

### Introduction

**T**he concept of controlling agricultural pests and diseases by spraying a control chemical is quite simple: merely apply the correct amount of the chemical evenly to the plant, leaving no area unprotected, and avoid applying the chemical to non-target areas.

The concept is simple, but achieving a uniform application is not. Many factors influence the uniformity of chemicals applied by spraying. The application is affected by physical factors such as nozzle type and size, application pressure and travel speed, type of chemical mix, and distance between nozzle and target. Environmental factors — i.e., temperature, wind velocity and relative humidity — also play an important role.

Non-uniform application results in overapplying or underapplying chemicals on parts of the crop. Overapplying sometimes results in burning or damage to the plant, while underapplying or entirely missing other parts may result in crop damage or loss from ineffective pest control. Either situation is an inefficient use of chemicals.

All spraying requires care and attention to details to achieve good results, but orchard spraying is generally more challenging and difficult to perform well than boom spraying in fields. Field spraying tends to be a two-dimensional problem involving an area to be covered. Orchard spraying adds a third dimension — height — and concern for the volume in the target area (i.e., size of trees). Other significant differences are the much greater distances between nozzles and target in orchard spraying and the amount of air used to carry spray to the tree.

This bulletin discusses the factors affecting air blast spraying using hydraulic nozzles with an axial fan and shows how to set up the nozzles correctly for effective spraying. Other sprayers that use air shear nozzles, radial fans, towers and air curtains are not included here.

### The Development of Orchard Sprayers

High-pressure guns were among the earliest spraying equipment used in orchard work. High pressure was required to drive the spray material from the gun up into the tree. Guns were directed by men who "swept" the tree with the spray attempting to get good coverage. It was slow and laborious.

As high-pressure spraying continued, guns were developed with multiple nozzles. These brooms gave a much wider coverage. These were followed by sprayers with multiple nozzles on a mast or tower. Some of these sprayers had oscillating nozzles on the mast in an attempt to improve spray delivery into the tree and reduce labor requirements.

This concept eventually gave way to the development of the air blast spraying principle, in which spray delivery was assisted by a large fan and moving air stream.

Today, air-assisted spray delivery continues to be part of the orchard spraying technique used in virtually all modern horticultural sprayers. Some air blast sprayers make use of a very high-velocity air stream that atomizes by air shear and drives the droplets into the tree in a wedge of turbulent, expanding air. Others use a lower velocity, high-volume air stream and high-pressure atomizer and operate on the principle of displacing the air in the tree with spray-laden air.

## Formation of Spray Droplets

Liquid is converted to a spray by some type of atomizer. The usual methods force the liquid through an orifice or shear it with high-velocity air. The size of the droplet produced will depend on the orifice diameter, the flow rate, the shape of the nozzle, the pressure on the liquid and the velocity of the shearing air stream.

### Orifice flow

Atomization takes place in a hydraulic nozzle as liquid under pressure flows through a relatively small orifice. The nozzle design determines whether the spray shape is a hollow cone, a full cone or a flat fan. Regardless of the spray shape, as the liquid is discharged from the orifice, it begins to disperse in an expanding pattern that forms a thin sheet, then expands further into strings and pieces and finally into droplets of various sizes.

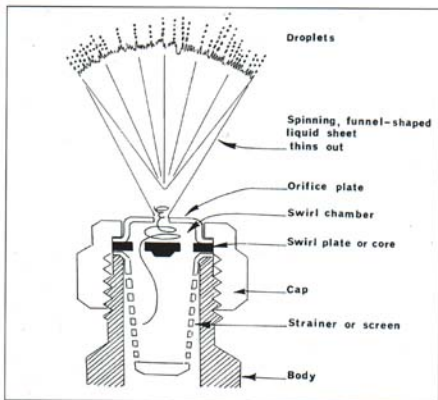

Fig. 1. Cross-section of a hollow cone nozzle.

## Atomization by air shear

When hydraulic nozzles are placed in an air stream, additional atomization or break-up occurs. The amount of atomization produced by the air stream depends on the direction of the nozzle discharge relative to the air stream direction. Spray directed into the air stream (maximum relative velocity) produces the finest droplets. Directing spray at 90 degrees to the air flow produces mid-sized droplets, and spraying in the same direction as the air flow gives the least air shear and the largest droplets.

When the relative air velocity is high, the atomization from the air shear may be sufficient that high-pressure swirl plates and atomizing nozzles are not necessary. Air shear may result from injecting the spray liquid into an air stream developed by a large fan (i.e., typical air blast sprayer) or dispensing it from a spinning disc (i.e., the "Micromax") or from a spinning cage, as in the "Micronaire" atomizers.

Regardless of the type of atomizer used, all current orchard sprayers employ some form of fan and air delivery system to aid in moving the chemical to the target.

## Nozzle Characteristics

The hydraulic spray nozzle controls three basic properties of operating conditions of the sprayer, and a clear understanding of these parameters will help in the selection of sprayer components and efficient sprayer operation. The nozzle controls:

1. The flow rate.
2. The size of the droplets.
3. The shape and type of the spray pattern.

### The flow rate

The flow rate for a hydraulic nozzle depends primarily on the nozzle design, the size of the orifice and the operating pressure. Though the flow does increase with pressure, it is not a linear ratio. All hydraulic nozzles conform to the basic principle that flow is proportional to the square root of the pressure:

$$\frac{\text{GPM}_1}{\text{GPM}_2} = \frac{\sqrt{\text{psi}_1}}{\sqrt{\text{psi}_2}}$$

That is, to double the flow rate, the pressure must be increased fourfold. For example: to double the flow rate of a nozzle at 20 psi, its pressure must be increased to 80 psi.

Adjusting pressure to modify flow is a useful technique, one that is used on most automatic controllers. Changes in sprayer speed are sensed by the controller and a corresponding change in pressure is made to compensate. Flow rate changes affected by pressure are limited, however. To make large changes in flow rate, it is more expedient to use a larger orifice nozzle.

Another characteristic of hydraulic nozzles that is important to understand for good spraying technique is the relationship between nozzle pressure and the size of the droplets emitted. Operating at high pressure increases the number of small and potentially driftable droplets. Operating suitable nozzles in the lower part of their pressure range can reduce the number of small driftable droplets. Droplet size of air shear and rotary nozzles is determined by factors other than hydraulic pressure.

## Droplet size

Even though all hydraulic nozzles produce a range of droplet sizes, the predominant size depends primarily on the nozzle design and operating conditions. It is well known that some chemicals work best when applied with large drops (systemic) while others work best with small droplets (contact). The spray technologist can greatly affect the efficiency of the spray by selecting the proper nozzles and droplet size.

For any spraying objective, there is a limited range of droplets that can be considered optimal. The higher the percentage of the spray that is in this range, the better will be the spraying efficiency. Very large droplets are wasteful. They contain a large proportion of the chemical and cover a very limited area. Often much of the chemical is lost to runoff from the plant foliage. On the other hand, very small droplets are also inefficient because they may drift away from the target on wind currents or evaporate before reaching the target. When tem-

peratures are high and humidity low, a large proportion of the very small droplets may be lost to evaporation. This is not a problem for large droplets that have considerable mass, but small droplets (5 to 40 microns) may be deflected by light breezes and may drift away.

When contact is important, spraying efficiency is improved by spraying with small droplets rather than large. With a given flow rate, many more droplets can be formed when the size is reduced. When the droplet diameter emitted by a nozzle is reduced to half the original droplet diameter, 8 times as many droplets are formed from the same flow rate. If the diameter is reduced to 1/10 the original size, there will be 1,000 droplets for each one of the original drops. Reducing droplet size is clearly an important technique for increasing the contact points of the spray on the target foliage.

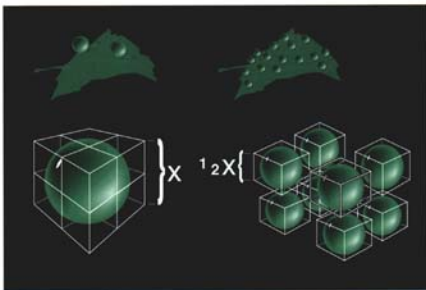

Fig. 2. Smaller droplets increase contact points.

Droplet size is typically given in microns (1/1,000,000) of a meter. To give this some perspective, consider that a human hair is approximately 100 microns in diameter. Many people will have some difficulty seeing droplets that are less than 100 microns. Or consider that it takes 25,460 microns to equal 1 inch.

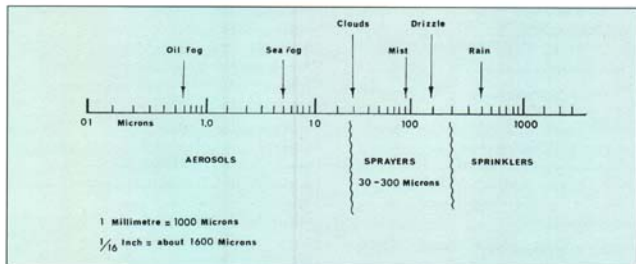

Fig. 3. Diameters of some common droplets.

Laser analyzers are used today to evaluate sprays and determine the size and number of the droplets in the spray spectrum. This analysis is used to determine the volume median diameter (VMD) of the spray, where half the volume is composed of droplets smaller than this number and half the volume is in larger droplets. A coarse spray (large droplets) has a higher VMD than a spray of fine droplets. The VMD is useful to describe the characteristic spray of a nozzle. The VMD should not be confused with the numerical median diameter (NMD), which is merely the median or midrange diameter (half the drops are bigger, half are smaller).

## The pattern or spray shape

The third parameter controlled by the nozzle is the pattern and spray angle emitted. These are characteristics designed into each nozzle. Though there is an endless variety of nozzles, there are only three basic patterns: the flat fan, the hollow cone and the full cone. The variety comes from variation on these three basic types and unlimited ways for the nozzles to function. Spray angles range from 65 to 120 degrees for flat fans and to very wide angles, 150 degrees or more, for flooding and hollow cone nozzles. Spray catalogs give the specifications for various nozzle performances.

In the case of a typical hollow cone nozzle, the liquid is forced through a swirl plate that causes it to spin. As the spinning fluid passes through the orifice, it forms a funnel-shaped sheet. The funnel expands as it moves away from the orifice, thins out and breaks into strings and then into particles that become droplets. Any interference with the swirling cone from nozzle irregularities, shape or air resistance will affect the size and uniformity of the droplets formed.

Full cone and flat fan nozzles, though differing in their spray shape, operate on the same principle — i.e., a thin sheet breaks up into strings and finally into droplets. The size of the droplets, the amount of spray volume emitted and the shape of the spray pattern are all determined by the physical characteristics of the nozzle.

A round orifice makes a cylindrical stream that travels far before breaking up into rather large

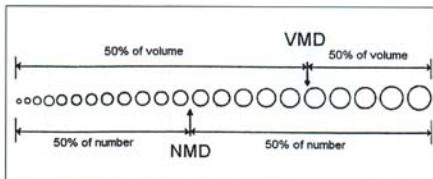

Fig. 4. Definition of VMD and NMD.

Low-volume sprays of 5 to 20 gallons per acre applied with small nozzles produce droplets in the 5 to 300 micron range. Medium volume sprays of 50 to 75 gallons typically range from 5 to 500 microns, while big nozzles and high volume produce droplets in the 20 to 1,000 micron range.



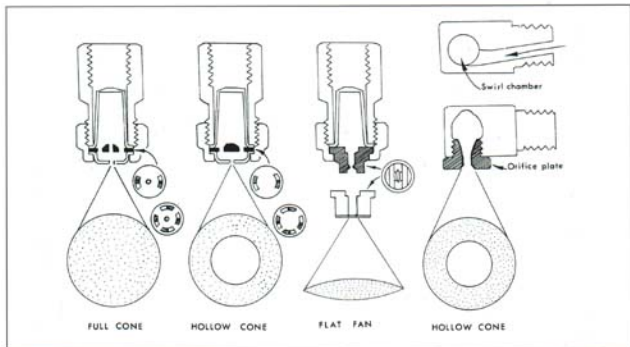

Fig. 5. Basic spray patterns.

droplets. When a swirl plate with one, two or four holes is added to the orifice, or a swirl chamber instead of the swirl plate, a hollow cone pattern is produced. A center hole in the swirl plate will fill in the pattern, producing a full cone pattern, and will give greater drive and penetration to the spray.

It is important to match the swirl plate and the orifice size on cone nozzles (refer to the catalog) so that a close pressure balance is achieved above and below the swirl plate. If a large orifice is used with a small capacity swirl plate, a low pressure will exist in the swirl chamber, resulting in excess wear in the swirl plate openings; on the other hand, a large capacity swirl plate used with a small orifice will cause high pressure in the swirl chamber and excessive wear on the nozzle disc and the underside of the swirl plate.

In spray guns with adjustable nozzles, the swirl plate position relative to the orifice is adjustable. If the swirl chamber between the plate and the nozzle is deep, a narrow spray pattern is produced, capable of reaching the tops of trees, with a pressure of 300 to 400 psi. A shallow chamber produces a wide spray pattern with fine droplets for close-up work. High pressure increases output but decreases droplet size. Larger orifices increase output but reduce spray width or spray angle.

A lens-shaped orifice and no swirl plate produces a flat fan spray pattern that tapers off on the edges. An oval-shaped hole produces a flat fan pattern with a rectangular shape as in even flat fan nozzles.

### Nozzle life

A frequently asked question is how long do spray nozzles last? Or conversely, how often should I change nozzles? This is a difficult question to answer. The wear rate depends on the abrasiveness and corrosiveness of the spray, the operating pressure of the nozzle and the nozzle material. And because of these variables, it is almost impossible to predict the life of a nozzle.

One thing is clear, however: the harder the nozzle material, the longer the useful life. Brass nozzles are soft and have a short life. They are also relatively inexpensive. On the other hand, nozzles made from tungsten carbide or ceramic material are very hard and have a very long wear life. Though they are more expensive, their increased life and reduced maintenance makes them cost-effective.

Table 1 gives comparisons of nozzle life and material. The cost of nozzles generally corresponds to the hardness of the material and the expected life of the nozzle—the harder materials cost more. A rule of thumb states that when nozzles wear to a point where volume flow for a specific pressure is

**Table 1. Nozzle life compared with brass.**

Material	Life
Aluminum	Same
Plastic or nylon	2 times
Stainless steel	3.5 times
Hardened stainless	10 to 20 times
Ceramic	75 to 120 times
Tungsten carbide	150 to 200 times

increased by 10 percent over the catalog value, the nozzle should be replaced because pattern and droplet size may be impaired. Wear may create an excess of large and small droplets and so move the spectrum out of the optimum size zone.

## Effective Spraying

The overall objective of spraying is to get the maximum control of agricultural pests and problems with the minimum application of chemicals. This implies effective, efficient and timely spraying.

The importance of selecting nozzles that produce the optimum droplet size for the desired spraying job has been discussed. Additional factors may improve or detract from good spraying.

## The travel speed

The ground speed of the sprayer has a major impact on how well the air blast penetrates the foliage of the trees. The faster the travel speed, the poorer the penetration and spray deposit. Travel speed and fan capacity are directly related.

Ground speed of the sprayer is a compromise. Travel velocity must be sufficient to get through the orchard in reasonable time but slow enough to do a creditable job of spray deposition. Speed will vary with size and spacing of trees, the air capacity of the sprayer and operator preference. A travel speed of 2 to 3 mph is typical for Michigan orchards with larger trees. Dwarf orchards with rows close together are often sprayed at 3 to 4 mph.

By measuring the tree width, height and travel speed the operator can calculate the volume of air that must be displaced by the sprayer. If the fan capacity does not measure up to the tree volume

required, poor spray deposit will result. A larger fan will be required or a slower travel speed.

## Wind and rain effects

Weather factors present some of the greatest challenges to spray timing and good deposition. Rain is one of the greatest obstacles — it disrupts spray schedules, provides moisture for fungi activities and washes protective sprays off the foliage. Fortunately, with some of the newer fungicides that have "reach-back" capabilities, many spray scheduling problems resulting from prolonged rain have been eliminated. (See "Improving Efficiency," p. 9, for a more complete discussion.)

Wind velocity and direction are always factors to consider. It is impossible always to spray "with the wind," and wind will reduce spray coverages, particularly when trees are open and in a dormant or pre-bloom stage. Coverage is improved and drift reduced when spraying is done in the calm conditions that usually occur at night or in early morning.

When situations require spraying in the wind, use an orchard driving pattern that works from the leeward side toward the windward side of the orchard. This will ensure working in clean air and avoiding potential drift. Also, drive the sprayer closer to the leeward side of the tree to assist the spray being directed into the wind from that side of the sprayer. Avoid all spraying when wind reaches 6 to 8 mph. Tall trees and/or wide row spacing requires calmer conditions for adequate coverage than small trees with closer spacing. Dwarf orchards with close row spacing are the easiest to spray in relatively higher wind conditions.

## Adjuvants

Adjuvants are management tools that can be added to a basic pesticide spray mix and greatly influence the performance of pesticide materials. They are grouped into several categories.

**Surfactants or wetting agents** are added to the spray water to reduce the surface tension and allow the water to break up into finer droplets. This increases the number of droplets and coverage from a volume of spray. The need for a wetting agent will depend on the type of chemical being applied, the concentration of the spray and the type of

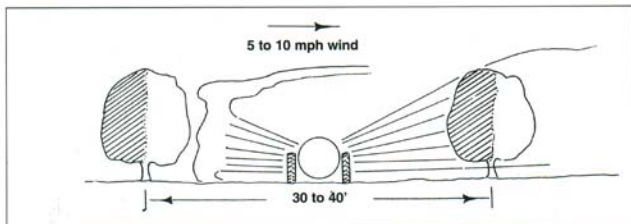

Fig. 6. Small standard trees on wide-row spacing. Note wind interference with spraying.

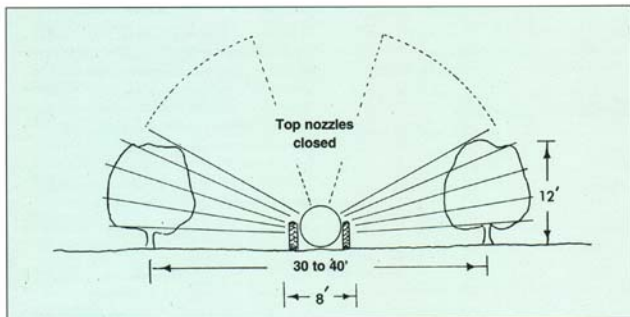

Fig. 7. Small trees on wide-row spacing require only half the spray pattern.

foliage being sprayed. Wettable powders and emulsifiable formulations may have sufficient wetting agent for dilute sprays. Concentrating the spray to four times or up to 10 times may increase the ratio of wetting agent to water to a point where it will cause excess wetting and runoff of the spray from the outer surfaces.

**Penetrating agents** are generally oil-based products that enhance the ability of the agrichemical to penetrate a surface or enter a substrate.

**Drift reduction agents** are adjuvants that reduce the proportion of fine droplets when added to the spray solution. These adjuvants tend to increase the

size and weight of droplets, thus reducing the number of droplets under 100 microns, which are most prone to drift off target.

**Retention agents or stickers** improve the adhesion property of the spray solution and improve the deposition.

Other additives include compatibility agents, antifoam agents, nitrogen additives and more. As management tools, they can make significant improvement in the performance of the sprayed material.

## Spraying technique for small trees

The typical conditions that exist in orchards make efficient, effective spraying a difficult goal. When trees are small and row spacing is wide, this becomes even more challenging. The spray must travel long distances from the nozzle to the tree, and small trees afford little windbreak protection, so even a light breeze can turn the spray away from its intended target. To compensate: (a) spray only in calm periods, (b) shut off top nozzles to avoid lofting the spray up into the air where it will drift, (c) shut off the spray between trees where there is no target to hit, (d) spray only one side of the row, (e) if spraying in a light wind is unavoidable, drive close to the lee side of the tree to maximize the spray deposition. It may be best to use a handgun to spray small trees until they become larger.

Small trees can be sprayed more easily and efficiently in a close setting than in a wide setting. When the rows are closer, the distance from the nozzle to the tree is shorter and the tree provides some wind protection. This improves spray deposition greatly even with double-sided application.

## Spraying large trees

Though the number of large standard trees in Michigan apple orchards is decreasing, there still is a high number of big trees of various types that need to be sprayed. The technique for spraying a tree 18 to 20 feet high is the same as that for the old standard trees, which could be considerably larger. Fruit trees present an ever-changing target for the sprayer. In the early spring, the dormant trees are an open framework of limbs and branches with little surface for this spray to hit. As the season progresses, leaves develop and increase in number and size. Fruiting and suckers develop. As fruit develops, the weight pulls branches down to give a canopy that is very difficult to penetrate with spray.

Because of the canopy and the usual way that spray is directed up into the tree by air blast spraying, the lower outside is often oversprayed in an attempt to get spray into the top inside of the tree. When nozzle discharge is evenly distributed throughout the air stream, leaves at the top of the tree receive about 1/6 of the deposition that the bottom outside leaves receive. This is due primarily to the divergent spray pattern and much greater travel distance from the sprayer to the treetop.

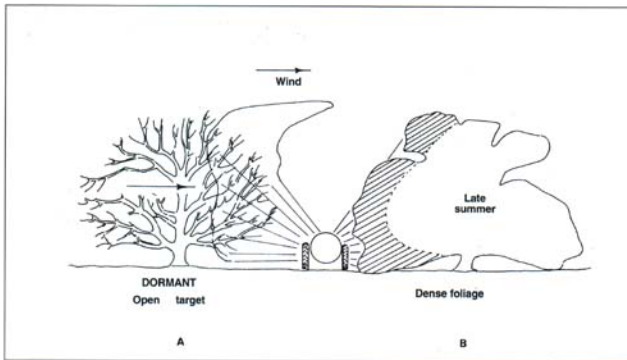

Fig. 8. A. Open framework of a dormant tree allows wind to pass through and stop the spray.

B. Dense outer canopy prevents good penetration.

Using proportionately larger nozzles in the top of the sprayer will compensate somewhat for this divergent pattern and greater distance. This is discussed below in "Nozzling the sprayer."

Though small droplets improve coverage, they require a higher airflow to reach their target, which may not occur in the treetops. Spray deposition in the tops of large trees by the traditional air blast sprayer may be greatly affected by evaporation, particularly if droplets are small. Evaporation on a hot, dry afternoon may reduce deposition to half or one-third of what it is at night or in the early morning, when humidity is high.

## Pruning to improve spray deposition

Trees that are unusually high (over 18 feet) and have very dense foliage are difficult to spray and achieve adequate uniform deposition. Spray deposits on these trees can be greatly enhanced by pruning to open the tree and limit its height. The trees must have a firm framework of limbs that will remain more or less in place throughout the season while supporting the crop. The solid canopy must be pruned to open it (i.e., remove selected limbs) so spray can get into the center of the tree. Opening

the tree will also permit better light into the center, enhancing fruit color and development.

## Improving Spray Efficiency

In past years, it was common practice to spray orchards on a schedule. Sprays were scheduled and applied on a frequency that would guarantee that insects and diseases would be covered, whether they were a threat or not.

Today chemicals are very expensive and highly toxic. Also, there is real concern that the crops and environment not be needlessly exposed to unnecessary chemical applications. It makes sense to use an integrated pest management (IPM) system, in which natural means to control pests are used as much as possible and practical, and chemical controls are used sparingly and in response to real problems, not those that "might be." This requires much more careful monitoring of the crop environment and insect development.

When chemicals are required, the timing of their application may be of vital importance. This is particularly true in the control of diseases such as apple scab. Rain initiates the apple scab activity but also impedes the spraying of fungicides to control it.

Some of the newer fungicides have a "reach back" of up to 96 hours from the beginning of the infection period. This means that the fungicide will be effective in preventing scab from developing for up to 96 hours following a rain. This makes the timing window much less critical than it was in the past. Because wet, rainy periods in the spring can often last two or more days, the length of the rain period, the "reach-back" time of the chemical and the time it takes for the sprayer to cover the

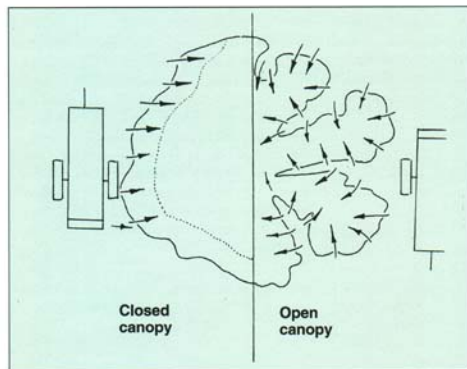

Fig. 9. Pruning to open the canopy for better penetration.

orchard must all be considered to have a timely, effective spray application. With the extended "reach back" of modern chemicals and high-capacity sprayers that are available today, it is rare to have to spray during the rain to have a timely spray application.

Though rain presents the greatest challenge to making timely spray applications, wind also frequently impedes timely spraying. Even with high-capacity air blast sprayers, many spring days will be so windy that spraying must be postponed. A frequently used technique is to spray at night when the air is calm.

As mentioned above, crop development and insect life cycles must be closely monitored so timely sprays can be applied. Chemicals that are effective and applied at the optimum time will give excellent control and make the most efficient use of the pesticide.

## Amounts of material to apply (dosage)

Though the effectiveness of spraying depends primarily on correct timing and applying the correct pesticide to the target, the dosage of the chemical and the carrier must still be considered. Chemical companies agree that, with an optimum job of spray application, most recommended chemical rates can be reduced without sacrificing control. However, recommended rates are based on pest conditions that tend toward the extreme side and an application technique that may not be particularly good. Thus, the recommended high rate will still result in acceptable control.

Rates recommended by Michigan State University are published in the fruit spraying calendar (E-154). Rates are based on standard-sized trees in full foliage sprayed to the point of impending runoff with dilute spray. In the case of apples and sweet cherries, this is 400 gallons/acre; 300 gallons/acre for tart cherries and 250 gallons/acre for peaches. When trees are less than standard size and concentrated spray is used in place of dilute (i.e., no runoff), adjustment is made to reduce the amount per acre accordingly. This is often referred to as the *tree-row volume spray rate*.

The volume of spray applied is also adjusted to account for the yearly stage of growth—i.e., dormant, blossom or full foliage; the amount of pruning; the type of chemicals being applied; and the concentration factor of the spray.

These factors are discussed in more detail in Part II under "Sprayer Set-up and Calibration."

## Sprayer deposition

The inherent nature of orchard spraying makes it difficult to predict the deposition effectiveness of the sprayer. Deposition is affected by the long distances from the nozzles to the tree foliage and the opportunity for drift and evaporation, the foliage density, spray rate (gallons per acre), droplet size, driving speed, air capacity of the sprayer and wind conditions.

Countless studies have been conducted in orchard spraying in an attempt to evaluate these parameters. The challenge has been to find out where the spray goes and how much is deposited in various parts of the tree. Several techniques have been used to determine these deposition rates. In one method, a fluorescent dye is added to the spray. Targets are placed in the tree or leaves are selected from certain representative places in the tree. After spraying, these are examined under a black light to see how much spray was deposited.

Another approach uses water-sensitive cards that are placed strategically in the tree. Following spraying, these are examined to determine the amount of spray and the droplet size that reached the various parts of the tree. Mylar or Kromecoat cards can be used, with a dye added to the spray. The spray deposited may be examined with a computer scan to give droplet size and coverage. Where too little spray is deposited, pest and disease control will be poor. Where excessive spray is deposited, costly chemicals are wasted, the environment is abused and foliage damage may occur.

The coverage samples shown in Fig. 10 represent a range from too little spray to excessive coverage. The optimum is midrange, numbers 4 to 7 (Fig. 11)

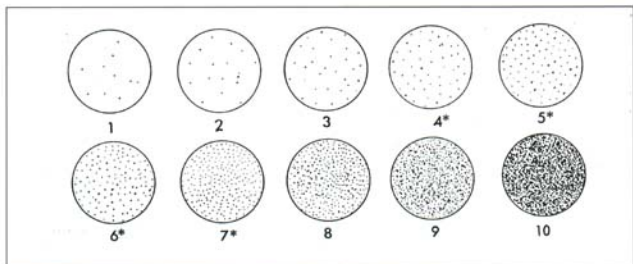

Fig. 10. Coverage rating guide. \* = preferred coverage range.

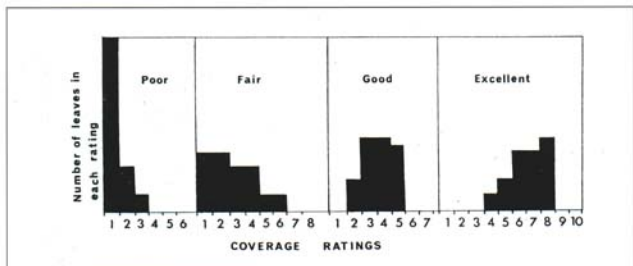

Fig. 11. Coverage pictures or histograms.

Though good pest control depends on a sprayer with adequate capacity for the size trees being sprayed and sufficient chemicals being applied to give good coverage, bad timing (outside the window of opportunity) will result in poor control even when the spray deposition is excellent. Good pest control depends on all parts of the application

being correct — timing to get the pest at the optimum time, use of the correct chemical in the proper amount and getting the spray on the target in an effective pattern.

## Part II: Sprayer Set-up and Calibration

### Selecting a Sprayer

Experienced growers will usually have very clear ideas about the features and capabilities that they prefer when selecting new sprayers. For new growers without experience, a few general guidelines may help remove confusion.

Air blast sprayers come in a range of sizes but can generally be put into three classes — small (10 to 35 hp), medium (40 to 60 hp) and large (70 to 120 hp). The sprayer size required is determined by the size and variety of the trees to be sprayed, the wind conditions under which spraying might need to be done and the size of the orchard that must be covered in the available time. The higher the spraying capacity, the higher the horsepower required. If the orchard is young, the size of the trees at maturity must be considered when selecting the sprayer.

The acreage that can be covered per tank of spray, the sprayer driving speed and time to refill will affect the size of the spray tank. To increase the acreage per tank, most spraying is now done with concentrated rather than dilute sprays. In concentrate spraying, the rate of chemical per acre remains the same, but the water is reduced by the concentration factor of 2x, 4x, 5x, 10x, etc., thus extending the area per tank by that much. For example, in 4x sprayers, four times as many trees can be sprayed per tank as with dilute spraying, reducing refills to one-fourth as many.

Additional features to consider when choosing a sprayer are: air volume and velocity should be sufficient to deliver turbulent air to the top portion of the trees, and air flow from the spray must be adjustable. Vanes and shrouds should be present to direct the air as needed or to discharge from one side only if required. Repair parts and service for the sprayer should be readily available so time lost to breakdowns can be kept to a minimum. This is vital at critical spray times. Field experience and advice from dealers or growers who have used a particular method are invaluable when making a final choice.

### Set-up and Nozzling

Once a suitable sprayer has been selected on the basis of factors such as tree type and size, the area of the orchard, the capacity of the pump, spray tank and fan, etc., the sprayer must be properly set up and nozzled to deliver the correct amount of spray within the time available.

In setting up a sprayer, the grower must first make some preliminary decisions based on experience or preference. These include spraying speed, gallons per acre to spray, whether to spray from one side only or both sides, and the concentration factor to use in forming the spray mix.

### Factors that affect spray volume

#### Basic dilute

A spray rate of 400 gallons/acre for full-sized standard apple trees has become the accepted standard in U.S. orchards. Years of experience and comparisons of various orchards have established that 400 gallons/acre will spray full-sized, moderately pruned apple trees planted on 35- or 40-foot rows to the point of impending drip or runoff. This is the reference point that is used for the university spray calendar and label recommendations. Typical spray recommendations give the amount (or range) of chemical per acre that is needed to control a pest or problem on standard-sized trees applied as dilute (1x).

Though standard-sized cherry and peach trees have not been defined, the dilute rate for tart cherries is usually based on 300 gallons/acre on 25-foot rows. Sweet cherries are usually based on 400 gallons/acre and peaches about 250 gallons/acre, as stated above.

Today, dilute spraying is rarely done. It is used only for special situations. The grower saves time, money and work by reducing the water and applying more concentrated sprays to the orchard. This



also usually improves the chemical deposition on the leaves because runoff is reduced. As the trees become more compact on dwarfing rootstocks, row spacing changes. And as the amount of foliage changes with pruning and the season, the amount of spray required for coverage also changes.

The factors that influence the amount of spray needed per acre are:

- Seasonal growth stage of the tree.
- Pruning factors or foliage density.
- Type of chemical — i.e., growth regulator or pesticide.
- Tree row volume — i.e., tree size and spacing.
- Concentration factor.

Starting with the dilute spray rate of 400 gallons/acre and adjusting it for each of these conditions, a new spray rate is calculated that is better suited to the existing conditions, more effective and more economical.

## Growth stages

The amount of foliage or surface area to be covered with spray varies greatly throughout the year in Michigan orchards. When the trees are dormant, the surface is minimum. The maximum surface to cover is present when the tree is at full foliage and a crop is nearing harvest. Obviously, more chemical and spray is required to cover a tree canopy at full foliage than is needed for a dormant or partially developed canopy.

The stage of growth factor is simplified by considering just two stages of growth:

Growth stage	Factor
1. No foliage (dormant) to petal fall	.80
2. Petal fall to full canopy	1.00

Very young, open trees, up to green tip, may warrant a growth factor of .6 or .7. Grower discretion is advised.

## Pruning factors

The amount of pruning that trees are subjected to greatly affects the total foliage, the openness of the tree and the amount of chemical spray needed for coverage. Work in North Carolina has resulted in several levels of canopy density to consider. These are summarized here as pruning factors that range from .7 for an extremely open or young tree to 1.3 for a tall, thick tree that has not received any pruning. Average pruning is considered to have a pruning factor of 1.0 because the basic rate of 400 gallons/acre was derived from average pruned orchards.

The basic dilute spray rate is multiplied by the pruning factor to arrive at an adjusted spray rate corresponding to the openness of the tree. (These factors are based on the standard-sized tree of 570,000 cubic feet/acre and 400 gallons/acre, which gives a rate of 1 gallon/1,450 cubic feet.)

Pruning condition	Factor
1. Trees extremely open or young with very few scaffold limbs	.7
2. Very open with light penetration throughout, 18 to 20 scaffold limbs	.8
3. Heavily pruned, adequate light and space in tree	.9
4. Normal/average pruning, light not visible in bottom two-thirds	1.0
5. Minimal pruning and limited light visible in tree	1.1
6. Very little or no pruning, weak or dead spurs	1.2
7. Tree unpruned, over 20 feet tall, thick, no light visible through tree	1.3

## Chemical type

The type of chemical applied to the orchard can affect the volume of water needed. Growth regulators such as thinning sprays and stop-drop chemicals as well as dormant oil sprays usually work best with a high volume of carrier. Insecticides and fungicides are generally more effective with a reduced amount of carrier. The following chemical factors can be used to modify the spray volume according to the type of chemical applied.

Chemical type	Factor
Growth regulators	
Thinning sprays	
Stop-drop chemicals	1.0
Pesticides	
Insecticide	
Fungicide	.7

These are general recommendations. If label instructions or experience indicate a different amount of chemical, use that value.

### Tree-row volume

The old standard trees, planted on 35- to 40-foot rows, had a size approximately 20 feet high and 23 feet wide that required spraying about 570,000 cubic feet of volume per acre. The volume of foliage (cubic feet/acre) varies, depending on the tree height, width and row spacing, and 570,000 cubic feet/acre is a reasonable volume for the old standard trees. As the typical apple tree found in orchards began to shift from the old standard-sized trees toward the newer dwarf trees, the canopy became smaller and the tree and row spacing were reduced. The newer dwarf rootstock trees with their smaller size and spacing present a different volume (cubic feet of foliage) per acre to spray. This has led to the concept of "tree-row volume" developed in North Carolina and Virginia.

The tree-row volume (TRV) for apples can be calculated or read from a graph. In either case, the row spacing, the height and the width must be determined. Care in making these measurements is necessary for an accurate volume per acre value.

TRV is calculated by finding the linear feet/row/acre and multiplying this by the height and width to get the volume/acre. The volume of the foliage in cubic feet/acre is multiplied by the standard of 400 gallons/acre for 570,000 cubic feet/acre.

For example: the TRV of trees planted in 25-foot rows, 15 feet high and 16 feet wide, is:

$$\text{TRV} = \frac{43560 \text{ sq ft/acre}}{25 \text{ ft/row}} \times 15 \text{ ft} \times 16 \text{ ft} = 418,176 \text{ cu ft/acre}$$

$$418,176 \frac{\text{TRV (cu ft)}}{\text{ac}} \times \frac{400 \text{ gal/acre}}{570,000 \text{ cu ft/acre}} = 294 \text{ gal/acre (dilute)}$$

The same value, 294 gallons/acre (dilute), is found using the graph at the intersection of the 25-foot row line and 240 square feet (width x height). (See Appendix A.)

**Note:** The tree-row volume concept works well on apples down to approximately 35 percent of standard dilute. There is less confidence at lower rates and with other fruit trees, such as cherries and peaches.

### Concentration factors

With all the factors affecting the dilute spray rate taken into consideration, a **final adjusted dilute** amount per acre is determined. The percentage that the **adjusted dilute** amount is of the 400 gallons/acre standard is also the *proportion of the chemical per acre* that should be applied. For example, if the **adjusted dilute** rate were 200 gallons/acre, the chosen rate per acre would need to be reduced by half (50 percent) (200 gallons/acre in the example + 400 gallons/acre, standard). However, as stated above, dilute spraying is rarely done. To reduce water and labor and improve spray efficiency, sprays are applied as concentrate. The amount of chemical per acre will remain constant, but the water volume is reduced by a factor of 2x, 3x, 5x, 10x or whatever the grower prefers. Or, stating this another way, to change from dilute to 3x spray, a sprayer would be nozzled to cover three times as many acres per tank as before, but the chemical in the tank would be increased three times to give the same chemical rate per acre.

Concentrate spray requires careful calibration, mixing and application because errors will be magnified.

### Nozzle selection

Once we have determined the tree and row dimensions and the influence of other factors, we can establish the **adjusted dilute** spray rate. This is the first step in nozzle selection.

## Adjusted dilute spray rate

Consider an example:

Apples - midseason

15 feet high, 16 feet wide  
25-foot rows, moderately  
pruned

Sprayed with: Captan (fungicide)  
Guthion (insecticide)

We must determine the **adjusted dilute** spray rate considering all the appropriate conditions.

**Adjusted dilute** = (basic dilute x TRV) x growth stage x pruning factor x chemical type

**Basic dilute** = 400 gal/570,000 cu ft /acre or  
1 gal/1450 cu ft of foliage/acre

**Tree-row volume (TRV)** = length of row/acre x tree height x tree width

TRV =  $\frac{43560 \text{ sq ft/acre}}{25 \text{ ft/row}} \times 15 \text{ ft} \times 16 \text{ ft} = 418,176 \text{ cu ft/acre}$

From the factors that affect spray volume discussed above:

The growth factor = 1 at midseason  
The pruning factor = 1 for moderate pruning  
The chemical type = .7 (the pesticide factor)

Combining all factors:

**Adjusted dilute** = (basic dilute x TRV) x growth x pruning x chemical

**Adjusted dilute** =

$\frac{1 \text{ gal}}{1450 \text{ cu ft/row}} \times \frac{418,176 \text{ cu ft}}{\text{ac}} \times 1 \times 1 \times .7$

**Adjusted dilute** = 201.9 gal/ac = 200 gal/ac.

## Spray concentration

To extend our spraying range per tank, we will concentrate the spray. A reasonable choice for our example is 5x. At 5x, we will apply 40 gallons/acre rather than 200 gallons.

$$\frac{200 \text{ gal/ac}}{5x} = 40 \text{ gal/ac}$$

If our sprayer holds 400 gallons, we can now cover 10 acres per tank. If we are going to spray 10 acres per tank, we must put sufficient chemical in to cover the 10 acres, or 10 times the adjusted chemical rate per acre.

The amount of chemical per acre that is specified by the spray calendar for dilute spraying is also affected by the ratio of:

$$\frac{\text{Adjusted dilute gal/ac}}{\text{Standard dilute gal/ac}}$$

In our example, this is:

$$\frac{200 \text{ gal/ac}}{400 \text{ gal/ac}} = .5$$

The chemical rate per acre is multiplied by a factor of .5. The amount of chemical is reduced by this factor (.5) and then held constant at this rate per acre, although the amount of water may change, depending on the concentration factor, as discussed below.

In our example, the *adjusted chemical rate* is .5x the chemical rate per acre for dilute spray.

If the dilute rate for Guthion is 2 pounds/acre, the adjusted chemical rate will be 2 x .5 or 1 pound/acre. The sprayer tank must be loaded with 10 x 1.0 or 10 pounds of Guthion.

Similarly, if Captan is required at 6 pounds/acre for dilute spray, our concentrated rate will be 10 x 6 x .5 or 30 pounds of Captan per tank to cover the 10 acres.

## Selecting nozzle sizes

With the concentrated spray rate now established, the next step with hydraulic nozzle sprayers is to select nozzles that will deliver the correct amount of chemical to the trees.

The disc and core types of nozzles are the usual choices for orchard spraying. They produce a very effective pattern and droplet size and can be easily and economically changed as flow conditions and wear require. With the sprayer in our example, nozzleed to deliver 40 gallons/acre, the nozzle flow rate in gallons per minute (gpm) will be determined by the spraying travel speed. This speed can be selected, within limits, by the operator. But the speed choice should be slow enough to ensure good spray deposition as described above. For our example, we will use 2.5 mph as the travel speed.

The formula to determine the gpm (gallons per minute) delivered by the sprayer is:

$$\text{gpm} = \frac{\text{gal/ac} \times \text{speed (mph)} \times \text{row width (ft)}}{495}$$

(The constant 495 results from the units in the formula.)

Example problem:

adjusted dilute = 200 gal/ac  
spray rate = 40 gal/ac (this is 5x)  
speed = 2.5 mph  
row spacing = 25 feet  
pressure (option) = 150 psi

$$\text{gpm (both sides)} = \frac{40 \times 2.5 \times 25}{495} = 5.05 \text{ gpm}$$

Our sprayer must deliver 5.05 gpm to apply 40 gallons/acre at 2.5 mph. Half of this amount (2.53 gpm) will be delivered by each side.

In conventional air blast sprayers that discharge the spray from a ground-level machine up into the tree, the manifold is nozzled to deliver two-thirds of

the spray flow from the top half of the manifold and one third from the lower half. This proportioning of the spray discharge is illustrated in Fig. 12, along with the concept of plugging unused nozzles to make the spray pattern conform to the target. Fig. 7 also illustrates this point. The two-thirds/one-third spray distribution works well with larger trees, but it may not be appropriate for semi-dwarf orchards.

In our example, we will assume that six nozzles per side will be used to deliver 2.53 gpm. It then becomes a process of selecting the correct nozzle sizes and whirl plates to give 1.69 gpm in the top half and .84 in the lower half.

Referring to a catalog of flow rates for disc and core nozzles, we find nozzles and swirl plates that will produce the desired flow. A portion of a nozzle catalog is shown in Table 2 to illustrate the various combinations of orifice size, swirl plates and pressures that are possible. The nozzles selected and their position on the sprayer are shown in Table 3 and Fig. 13.

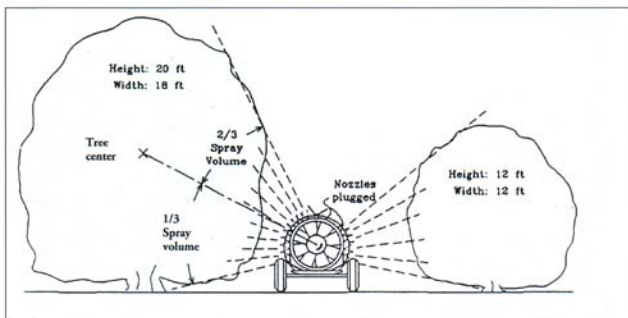

Fig. 12. Sprayer nozzling for good deposition.

**Table 2. Hollow cone flow rates.\***

Hollow Cone Spray Pattern															
Orifice Disc No.	Core No.	Orifice Diam.	Capacity (Gallons Per Minute) at psi (Pounds per Square Inch)										Spray Angle		
			10 psi	20 psi	30 psi	40 psi	60 psi	80 psi	100 psi	150 psi	200 psi	300 psi	20 psi	40 psi	
D1	13	.031*	—	—	.059	.096	.078	.088	.097	.115	.128	.152	—	51°	62°
D1.5	13	.036*	—	—	.057	.067	.075	.086	.096	.110	.127	.142	.157	38°	55°
D2	13	.041*	—	—	.064	.075	.08	.10	.11	.12	.14	.16	.18	49°	67°
D3	13	.047*	—	—	.071	.08	.09	.11	.12	.13	.16	.18	.20	53°	70°
D4	13	.063*	.070	.09	.11	.12	.14	.16	.17	.20	.23	.27	.69	79°	83°
D1	23	.031*	—	—	.064	.072	.080	.096	.107	.124	.139	.164	—	47°	58°
D1.5	23	.036*	—	—	.064	.076	.086	.103	.117	.130	.155	.175	.210	34°	51°
D2	23	.041*	—	—	.078	.092	.10	.13	.14	.16	.19	.21	.25	51°	63°
D3	23	.047*	.065	.087	.10	.12	.14	.16	.18	.21	.24	.28	.58	69°	75°
D4	23	.063*	.082	.113	.14	.15	.19	.21	.23	.28	.32	.38	.68	82°	87°
D5	23	.078*	.095	.13	.16	.18	.22	.25	.28	.34	.38	.46	.79	89°	94°
D6	23	.094*	.112	.15	.19	.21	.26	.29	.32	.39	.45	.54	.84	93°	98°
D1	25	.031*	—	—	.068	.101	.122	.138	.156	.185	.210	.255	—	27°	43°
D1.5	25	.036*	—	—	.118	.135	.162	.185	.205	.245	.280	.33	—	38°	49°
D2	25	.041*	—	—	.12	.14	.16	.19	.22	.25	.29	.34	.41	39°	51°
D3	25	.047*	.10	.14	.17	.19	.23	.26	.29	.35	.40	.48	.52	61°	67°
D4	25	.063*	.15	.21	.25	.29	.35	.40	.45	.54	.62	.75	.67	74°	80°
D5	25	.078*	.18	.25	.30	.35	.42	.48	.54	.65	.75	.90	.73	79°	84°
D6	25	.094*	.23	.32	.39	.44	.54	.62	.70	.85	.97	1.19	.79	85°	89°
D7	25	.109*	.26	.37	.45	.52	.63	.73	.81	.98	1.18	1.37	.85	91°	93°
D8	25	.125*	.31	.43	.53	.63	.75	.89	.97	1.19	1.36	1.68	.91	96°	97°
D10	25	.156*	.38	.54	.65	.76	.93	1.07	1.21	1.48	1.71	2.1	.97	102°	103°
D12	25	.188*	.46	.61	.80	.93	1.15	1.32	1.47	1.81	2.09	2.55	1.03	109°	112°
D14	25	.219*	.51	.72	.88	1.03	1.26	1.47	1.65	2.02	2.34	2.89	1.08	113°	114°
D1	45	.031*	—	—	.125	.148	.170	.190	.225	.257	.310	—	22°	34°	
D1.5	45	.036*	—	—	.14	.16	.20	.23	.25	.31	.35	.43	—	33°	44°
D2	45	.041*	—	—	.14	.16	.20	.25	.28	.32	.38	.44	.53	32°	46°
D3	45	.047*	—	—	.17	.20	.23	.28	.33	.36	.44	.51	.62	40°	53°
D4	45	.063*	.18	.25	.31	.36	.43	.50	.56	.68	.78	.95	.62	69°	72°
D5	45	.078*	.23	.32	.39	.45	.55	.64	.71	.86	.99	1.22	.67	73°	76°
D6	45	.094*	.29	.41	.50	.58	.72	.83	.93	1.15	1.33	1.64	.73	79°	81°
D7	45	.109*	.33	.48	.59	.68	.84	.97	1.11	1.35	1.57	1.94	.81	86°	87°
D8	45	.125*	.41	.59	.72	.84	1.04	1.21	1.35	1.68	1.94	2.40	.86	90°	90°
D10	45	.156*	.54	.77	.94	1.10	1.35	1.57	1.77	2.18	2.50	3.10	.90	93°	93°
D12	45	.188*	.67	.95	1.17	1.36	1.68	1.95	2.20	2.69	3.11	3.80	.97	100°	102°
D14	45	.219*	.75	1.07	1.32	1.53	1.89	2.19	2.45	3.00	3.49	4.30	1.04	104°	105°
D16	45	.250*	.86	1.25	1.54	1.79	2.20	2.57	2.89	3.54	4.11	5.20	1.08	111°	112°

\*Excerpt from Spraying Systems Catalog. Other manufacturers' nozzles are equally acceptable.

**Table 3. Flow rates - selected disc and core nozzles.**

Flow at 150 psi					
Nozzle no.	Disc no.	Core no.	Flow - gpm	Totals	
1	Not used				
2	D5	25	.65	1.69	
3	D5	25	.65		
4	D6	23	.39		
5	D4	23	.28	.84	
6	D4	23	.28		
7	D4	23	.28		
8	Not used				
Total: 2.53 gpm					

The choice of orifice number and core number within each pressure range will determine the nozzle flow rate. There is considerable flexibility, depending on the combinations chosen. The flow rate resulting from the combination of orifices and cores finally selected should match the foliage profile of the tree. The high flow rate should be directed toward the top and the total flow of all nozzles must be close to the required rate per acre (40 gallons/acre) as previously determined.

With the sprayer nozzleed with the nozzles selected above and the sprayer operated in the orchard at the pressure of 150 psi and traveling 2.5 mph, the delivery should be close to 40 gallons/acre and dispersed correctly in the trees. Frequent checks are always in order to be sure things are as they should be. Conditions in the orchard change throughout the season; trees increase in foliage and density. The weather is always a changing variable with changes in temperature, humidity and wind affecting the spraying operation. The effective grower will take all these factors into consideration.

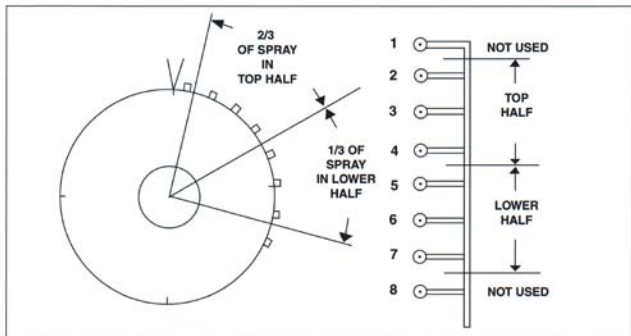

Fig. 13. Nozzle selection to deliver two-thirds in the upper half.

## Calibration

Good spraying requires the sprayer to be properly set up, adjusted and calibrated.

### Precalibration check

A precalibration check will involve:

1. Cleaning the filters or strainers to ensure good fluid flow.
2. Checking nozzles for worn or plugged nozzles or incorrect sizes.
3. Inspecting the fan for damage or dirt that will impede air flow.
4. Checking air flow around nozzles — check with air on and spray off.
5. Checking for leaks and flow — use water for convenience and safety.
6. Examining the general condition of the sprayer — frame, wheels, hitch, drive line, etc.

### Pressure check

The pressure of the nozzle affects nozzle flow. Temporarily install a liquid-filled gauge on the boom manifold to compare boom pressure with the system pressure gauge. Note any differences in

pressure that need to be accounted for to achieve proper boom manifold pressure.

### Travel speed

Use a measured distance (100 to 200 feet) in the orchard. Time the travel speed under spraying conditions — i.e., sprayer half full of water, gear and throttle set for spraying. Note the throttle position or tachometer reading that corresponds to this speed.

$$\text{Speed (mph)} = \frac{\text{distance (feet)} \times 60}{\text{time (sec)} \times 88}$$

As the season progresses and tree density increases, you may need to travel (and spray) at a slower speed to get the same results as you did early in the season.

### Flow calibration

Calibration is most often done on air blast sprayers by a tank refill method. This method carefully measures the amount of tank refill (gallons) after a known area (acres) has been sprayed under typical operating conditions. The gallons needed for refill divided by the area sprayed equals the gallons/acre applied. If the rate needs to be adjusted up or down, change travel speed, pressure or nozzle size to obtain the desired result.

The area sprayed (acres) results from:

$$\text{Area} = \frac{\text{row width (feet)} \times \text{row length (feet)}}{43560 \text{ sq ft/ac}}$$

The gallons per acre applied is calculated from the equation given on page 16.

$$\text{GPA} = \frac{495 \times \text{gpm (total flow)}}{\text{speed (mph)} \times \text{row width (feet)}}$$

An alternate technique to measuring the tank refill (amount/area) is to use a flow meter on each active nozzle and arrive at a total flow rate (gpm) for the manifold boom.

Lacking a flow meter, total nozzle flow can be determined by connecting a hose to each nozzle and collecting the discharge in a bucket. Measuring the total gives the total flow rate (flow/unit time) or gpm.

## Deposition adjustment

Spray distribution within the tree can usually be determined by putting water-sensitive cards on a pole that is placed in the tree. These are sprayed and the water marks from the droplets analyzed to determine how the spray is contacting the tree. This information is then used to modify nozzle sizes and position to achieve the best spraying result.

The most important criteria for evaluating good chemical application are how the crop is doing and how well the pests are controlled. Observed results may indicate that significant changes in chemical amount, application timing or technique, etc., are in order — or they may indicate everything is OK.

With any chemical application system, a skillful, observing operator is the most important part of a successful operation.

## References:

- Byers, R.E. 1987 Tree-row-volume spraying rate calculator for apples. *Hort. Science* 22(3): 506-507.
- Canada Department of Agriculture. 1978 *Air Blast Orchard Sprayers (Operation and Maintenance)*. Publication 1625. Ottawa, Ont.
- Fisher, R.W., D.R. Menzies, A. Hikichi. 1976. *Orchard Sprayers (A Guide to Ontario Growers)*. Publication 373. Vineland Station, Ontario: Ontario Ministry of Agriculture and Food.
- Sutton, T.B. and C.R. Unrath. 1986. Evaluation of the tree-row-volume concept with density adjustments in relation to spray deposits in apple orchards. *Plant Dis.* 68: 480-484.
- Unrath, C.R., T.B. Sutton and J.D. Obermiller. 1986. *A Tree Row Volume Model for Determining Proper Spray Rates in Apple Orchards*. Educational Publication for N. C. Apple Growers Assoc. Fletcher, N.C.: North Carolina State Univ. Agric. Research and Extension.
- Wilkinson, R.H. 1994 *Chemical Applications in Agriculture*. North Central Regional Extension Publication NCR 520. East Lansing, Mich.: Michigan State University.



## Appendix A

### Tree-Row Volume Graph

Courtesy of Lyons and Byers (V.P.I.)

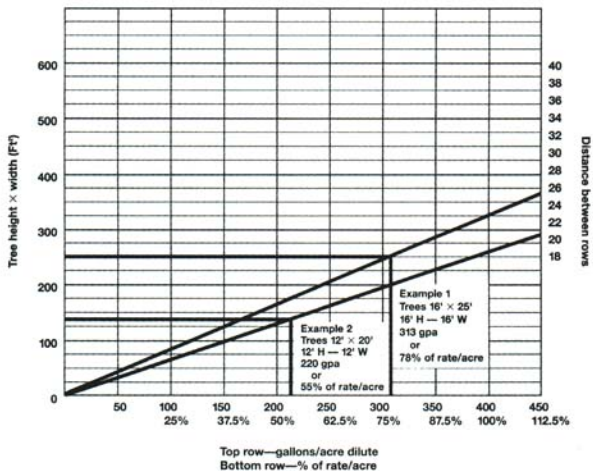



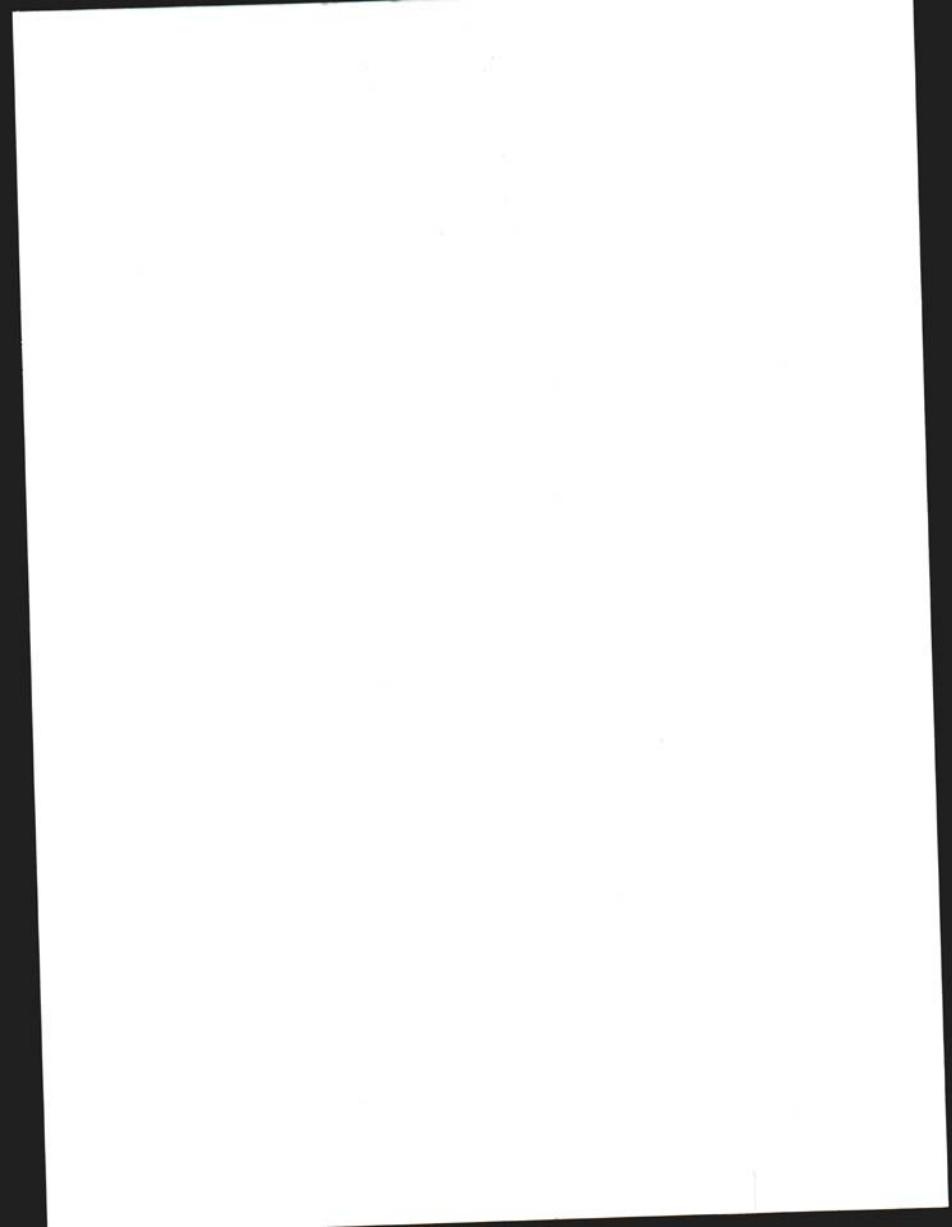

MICHIGAN STATE  
UNIVERSITY  
EXTENSION

MSU is an affirmative-action equal-opportunity institution. Michigan State University Extension programs and materials are open to all without regard to race, color, national origin, gender, religion, age, disability, political beliefs, sexual orientation, marital status, or family status. ■ Issued in furtherance of Extension work in agriculture and home economics, acts of May 8 and June 20, 1914, in cooperation with the U.S. Department of Agriculture. Arlen Leholt, Extension director, Michigan State University, E. Lansing, MI 48824. ■ This information is for educational purposes only. Reference to commercial products or trade names does not imply endorsement by MSU Extension or bias against those not mentioned. This bulletin becomes public property upon publication and may be printed verbatim with credit to MSU. Reprinting cannot be used to endorse or advertise a commercial product or company. Produced by ANR Communications. New 2-00-3M-KMF/JP, \$3.00 for sale only. (Fruit-Commercial)