

\$1.90

Extension Bulletin E-1824
(formerly E-1032) Reprinted Feb. 1985
COOPERATIVE EXTENSION SERVICE
MICHIGAN STATE UNIVERSITY

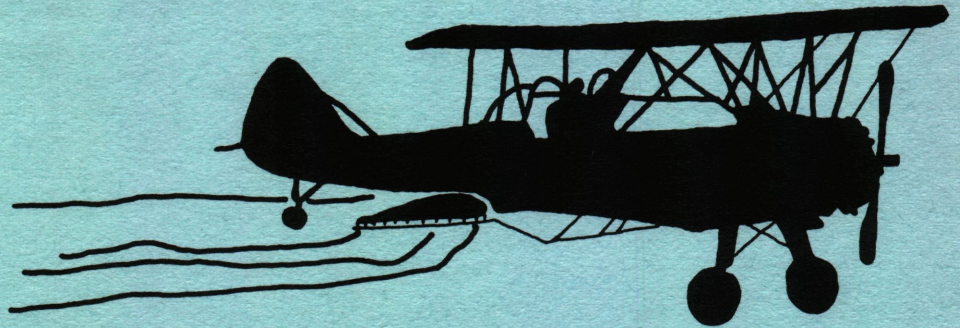

SAFE, EFFECTIVE USE OF PESTICIDES

A MANUAL FOR COMMERCIAL APPLICATORS



Procedures for Certification of Commercial Applicators

A person desiring to become certified as a commercial applicator in the State of Michigan is required to successfully complete a minimum of two written examinations, one addressing the general standards set forth in the federal regulations (40 CFR 171.4(b) and 171.6), and the other(s), the specific requirements of the category or subcategory (40 CFR 171.4(c) and Regulation 636 Rule 4). A person who applies pesticides by aircraft or by space fumigation is required to successfully complete an examination for the method of application employed (Regulation 636 Rule 4(b)).

Examination questions will be based on study materials contained in the training manuals that have been developed by the Michigan State University Cooperative Extension Service. Each manual is designed to

be self-teaching and contains a study guide with self-help questions at the end of each section. This manual addresses only the general standards required of all commercial applicators. The specific standards required for the category or subcategory, and the additional requirements for aerial application or space fumigation, are contained in separate unit manuals. Check the unit manuals received to assure that you have the necessary study materials for each category or subcategory in which you desire to become certified.

Examinations will be given by appointment at any of the examination sites listed on the fee receipt card that has been returned to you. Bring the fee receipt card with you to the examination site and present it to the examination monitor for admittance.

SOME SUGGESTIONS FOR STUDYING THIS MANUAL

The information presented in this manual is designed to assist prospective commercial applicators to meet the certification requirements under the federal guidelines. You may already know some of it from your experience with pesticides. The manual has eight sections. A list of self-help questions and instructions for completing the questions are contained at the end of each section. These questions are to assist you in your studies and are not necessarily the questions on the certification examination. If you encounter difficulties in using the manual, please consult your county extension agricultural agent or representative of the Michigan Department of Agriculture for assistance.

Some suggestions for studying the manual are:

1. Find a place and time for study where you will not be disturbed.
2. Read the entire manual through once to understand the scope and form of presentation of the material.

3. Then study one section of the manual at a time. You may want to underline important points in the manual or take written notes as you study the section.
4. Answer, in writing, the self-help questions at the end of each section. Instructions on how to use the self-help questions in your study are included with the questions. These questions are intended to aid you in your study and to help you evaluate your knowledge of the subject. As such, they are an important part of your study.
5. Reread the entire manual once again when you have finished studying all of its sections. Review with care any sections that you feel you do not fully understand.

This manual is intended to help you use pesticides effectively and safely when they are needed. We hope that you will review it occasionally to keep the material fresh in your mind.

SAFE, EFFECTIVE USE OF PESTICIDES

A MANUAL FOR COMMERCIAL APPLICATORS

Fred H. Tschirley, Dept. of Botany & Plant Pathology, Michigan State University

Artwork by:
Marian Mahler
Donald Mainfort
Lana Tackett

SECTION 1: Pesticide Laws



Public Law 92-516
92nd Congress, H. R. 10729
October 21, 1972

An Act

to amend the Federal Insecticide, Fungicide, and Rodenticide Act, and for other purposes.

86 STAT. 9

Be it enacted by the Senate and House of Representatives of the United States of America in Congress assembled, That this Act may be cited as the "Federal Environmental Pesticide Control Act of 1972".

Federal
Environm
Pesticid
Control
of 1972

AMENDMENTS TO FEDERAL INSECTICIDE, FUNGICIDE, AND RODENTICIDE ACT

SEC. 2. The Federal Insecticide, Fungicide, and Rodenticide Act (7 U.S.C. 135 et seq.) is amended to read as follows:

61 Sta
78 Ste

"SECTION 1. SHORT TITLE AND TABLE OF CONTENTS.

"(a) SHORT TITLE.—This Act may be cited as the 'Federal Insecticide, Fungicide, and Rodenticide Act'.

TABLE OF CONTENTS.—

FEDERAL LAWS AND REGULATIONS

Federal Environmental Pesticide Control Act

The Federal Environmental Pesticide Control Act (FEPCA) of 1972 substantially amends the Federal Insecticide, Fungicide, and Rodenticide Act (FIFRA) of 1947. FIFRA was administered by the Department of Agriculture until authority was transferred to the Environmental Protection Agency in 1970.

Here are some of the major provisions provided by the 1972 amendments which are most important to you:

1. All pesticide uses must be *classified* as either general or restricted.
2. Pesticide applicators must become *certified* if they wish to use restricted pesticides.
3. The 1972 law extends to the states the authority to certify applicators, register pesticides, and initiate programs designed to meet their local needs.
4. EPA and the states will engage in a cooperative program in enforcement of the law and training needs.

5. The act provides civil penalties and criminal penalties for individuals who violate provisions of the act.

There are several unlawful acts defined in the amendments which affect both pesticide producers and the ultimate users. The unlawful acts which are important to you are listed below:

- Detach, alter, or destroy any part of a label.
- Refuse to keep records, refuse to permit inspection, or refuse to permit sampling.
- Make a restricted use pesticide available to anyone not certified.
- Use a restricted use pesticide unless the applicator is certified, or the application is made by a competent person under the direction or supervision of a certified applicator.
- Use any registered pesticide in a manner inconsistent with its labeling.

Civil Penalties

A private applicator who violates the Act after a written warning, or after a citation for a prior violation, may be assessed a fine of not more than \$1,000 for each offense.

Any commercial applicator who violates the act may be assessed a fine of not more than \$5,000 for each offense.

Criminal Penalties

A private applicator who *knowingly* violates the act is guilty of a misdemeanor and upon conviction, may be fined not more than \$1,000 or imprisoned for not more than 30 days, or both.



A commercial applicator who knowingly violates the act is guilty of a misdemeanor, and upon conviction, may be fined not more than \$25,000 or imprisoned for not more than one year, or both.

Regulations

Transportation: Shipment of pesticides and other dangerous substances across state lines is regulated by the Federal Department of Transportation (DOT). The DOT's Hazardous Materials Regulations Board issues the regulations for preparing these materials for transportation. The board has grouped the materials into three classes, with separate standards for each class. Most pesticides are in the middle category — "Class B poisons." This means that they are somewhat dangerous poisons which are toxic to man and which create a health hazard during transportation.



Aerial application: Application of pesticides from airplanes is regulated by the Federal Aviation Administration (FAA). Under FAA regulations it is illegal for an aerial applicator to apply any pesticide except according to federally registered use. FAA determines the flying ability of agricultural pilots and the safety of their aircraft. All pilots *must* be certified before they may apply restricted use pesticides.

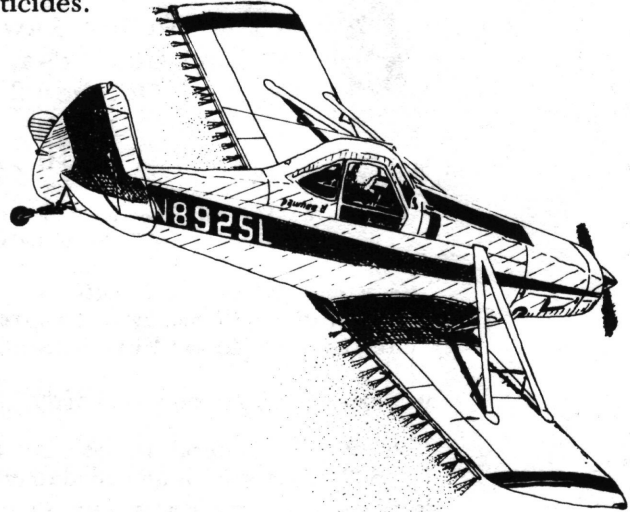

Residues: Another law regulates the amount of a pesticide that may remain on raw agricultural products — the *residue*. These amounts (called tolerances) are set by EPA when the pesticide use is registered. Tolerances are expressed in terms of parts by weight of the pesticide for each 1 million parts by weight of the agricultural product. The same pesticide may have a different tolerance on different products. For example, it might have a tolerance of 50 parts per million (PPM) on grapes and 25 PPM on apples.

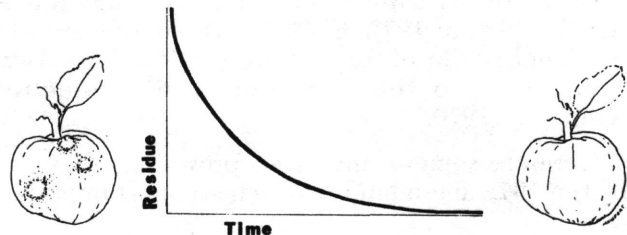

If too much residue is found on a product being shipped from one state to another, the shipment may be seized and destroyed.

Instructions on all pesticide labels take these tolerances and residues into account. They will tell you how many days before harvest the pesticide may be applied. By following the directions exactly, you can be sure that you are not violating the law.

Occupational Safety and Health Act of 1970

The purpose of Congress in passing this law was to assure safe and healthful working conditions for every working man and woman in the nation, and to preserve our human resources.

The OSHA requires anyone with eight or more employees to keep certain records and make periodic reports. Most importantly, he must keep good records of all *work-related* deaths, injuries and illnesses. Minor injuries needing only first aid treatment need not be recorded. But a record must be made if the injury involves:

- medical treatment,
- loss of consciousness,
- restriction of work or motion, or
- transfer to another job.

MICHIGAN PESTICIDE CONTROL ACT

The Michigan Pesticide Control Act was enacted to conform with the requirements of the FEPCA. The act gives authority to the director of the Michigan Department of Agriculture to register pesticides sold within the state and to register pesticides for special local needs. Authority is also granted for the director to certify applicators who use restricted use pesticides, license pesticide applicators engaged in the business of applying pesticides, and license dealers who sell restricted use pesticides.

The act gives the director authority to promulgate regulations for carrying out the provisions of the act, including but not limited to regulations providing for:

1. The collection, examination, and reporting the results of examination of samples of pesticides or devices.
2. The safe handling, transportation, storage, display, distribution, and disposal of pesticides and their containers.
3. The designation of restricted use pesticides for the state or for specified areas within the state. The Director may include in the regulation the time and conditions of sale, distribution and use of such restricted use pesticides.
4. The certification and licensing of applicators, and the licensing of restricted use pesticide dealers.
5. Requiring certified commercial applicators to maintain records with respect to applications of restricted use pesticides and make such reports as the director shall require by regulation.
6. Good practice in the use of pesticides.
7. Certified applicators to use a pesticide in a manner consistent with its labeling including adequate supervision of noncertified applicators where appropriate.

The director is authorized to enter upon any public or private premises or other place, includ-

ing vehicles of transport, where pesticides or devices are being used or held for distribution or sale, for the purpose of inspecting and obtaining samples of any pesticides or devices or inspect equipment or methods of application.

A summary of the provisions of the act which are most applicable to the certification of pesticide applicators is provided below to aid you in familiarizing yourself with the Act.

Pesticide Applicators

- Any person who uses or supervises the use of a restricted use pesticide is required to be certified.
- Any person who shall advertise in any form or who holds himself out to the public as being in the business of applying pesticides shall obtain a license prior to engaging in such business.
- A licensed applicator shall comply with the certification requirements whether he uses a restricted use pesticide or not.
- Certification requirements are prescribed in regulations promulgated by the director.
- A certification fee of \$10 must accompany the application for a certificate.
- Certification is valid until revoked or for a period of three years.
- A license fee of \$20 must accompany the application for a license or renewal. The license shall expire December 31 annually.
- Licensed applicators must provide proof of financial responsibility.

Restrictions; Denial of Certificate or License

1. The certificate or license may restrict the applicant to use a certain type of equipment or pesticide if the director finds that the applicant is qualified to use only such type.
2. The director may refuse to issue a certificate or license or renewal thereof if the applicant demonstrates an insufficient knowledge of any item called for in the application, has unsatisfied judgments against him, or if the equipment to be used by the applicant is unsafe or inadequate to accomplish proper application of the pesticides to be used.
3. If the director does not qualify the applicant under this section, he shall inform the applicant in writing of the reasons therefore.

Exemptions from Act

1. Employees of a certified private applicator while acting under the supervision of such applicator.
2. Commercial applicators applying general use pesticides indoors other than insecticides, rodenticides, avicides and molluscicides.
3. Persons applying general use pesticides on their own premises, or employees of such persons on such premises.

4. Doctors of medicine and doctors of veterinary medicine applying pesticides during the course of their normal practice.
5. Persons conducting laboratory type research involving restricted use pesticides.

Reciprocity

The Director may enter into reciprocal agreements with other state or federal agencies for the purpose of accepting certification required for pesticide applicators, provided that such states or federal agencies have an approved program to certify applicators, and provided further that the requirements for certification by such states or federal agencies equal or exceed the certification requirements of this state.

Liability

A certificate or license issued by the director shall not exonerate the holder from responsibility for damage resulting from misuse of pesticides such as, but not limited to, overdosing, drifting, or misapplication.

Restricted Use Pesticides

Sales or distribution of restricted use pesticides shall be limited to licensed restricted use pesticide dealers for resale or distribution to applicators certified under this act.

Enforcement

Stop use order: Whenever the director shall have reason to believe that an applicator is using or intending to use a pesticide in an unsafe or in-

adequate manner, or in a manner inconsistent with its labeling, the director shall order the applicator to cease the use of or refrain from the intended use of such pesticide, mixtures, equipment or methods. The order may be either oral or written, and must inform the applicator of the reason therefore.

Upon receipt of the order, the applicator shall immediately comply therewith. Failure to comply constitutes cause for revocation of the license or certification and subjects the applicator to the penalty imposed under section 16 of the Michigan Pesticide Control Act.

The director of agriculture shall rescind the order immediately upon being satisfied after inspection that the reason therefore does not or no longer exists. The inspection shall be conducted as soon as possible at the request of the applicator, which may be either oral or written. The rescinding order of the director may be oral and the applicator may rely thereon. However, an oral order shall be followed by a written rescinding order.

Revocation, suspension of certificate or license: The director may at any time revoke or suspend a certificate or license for a violation of this act or regulations, or any order issued hereunder or upon conviction under section 14 of the FIFRA, or upon conviction of any state pesticide law of any reciprocating state.

Penalty

Any person who shall violate any of the provisions of the Michigan Pesticide Control Act or regulations promulgated thereunder is guilty of a misdemeanor. Fines are levied at the discretion of the court.

Self-Help Questions on Section 1 – Pesticide Laws

Now that you have studied Section 1, answer the following questions. Write the answers with pencil without referring back to the text. When you are satisfied with your written answers, see if they are correct by checking them with the text. Erase your answer and write in the correct answer if your first answer is wrong. Note that these questions are not necessarily those that are used in the certification examination.*

1. *What agency administrates the federal pesticide laws?*
2. *What are some unlawful acts defined in the federal law?*
3. *Can violators of the pesticide laws be imprisoned?*

*The questions are arranged in the order that they appear in the text.

4. *What agency regulates the shipment of pesticides across state lines?*
5. *Is it legal for an aerial applicator to apply a pesticide that is not registered?*
6. *What is meant by a pesticide residue?*
7. *Are you required to keep health and safety records under the Occupational Safety and Health Act if you employ five people?*
8. *Who administrates the Michigan Pesticide Control Act?*
9. *Who needs to be certified for pesticide application under the Michigan law?*
10. *Does a licensed applicator also require certification if he does not use restricted use pesticides?*
11. *Does a person working under the supervision of a certified applicator also need to be certified?*
12. *Do dealers selling restricted use pesticides need to be licensed?*
13. *What does a stop use order mean?*

SECTION 2: Labels and Labeling

What is a label? What is labeling? They are similar words, but they do not mean exactly the same thing. First let's discuss the *label*. You know that it is the information printed on the can, box or bag of pesticides. This label serves many purposes:

- To the manufacturer, the label is a "license to sell."
- To the state or federal regulatory agency, the label is a way to control the production, distribution, storage, sale, use and disposal of the products.
- The label is also the best way for regulatory agencies to tell users about necessary safety and environmental precautions.
- To the buyer or applicator, the label is the best source of information needed to use the product safely.

PARTS OF THE LABEL

Brand Name

Every product has its own brand name. This tells you what company the product came from.

The brand name is featured prominently on the front panel, and is the most advertised and identifiable name for the product.

Common Name

The common name for a chemical is a name agreed upon to identify an active ingredient in a product. A chemical manufactured by more than one company may be sold under several *brand names*, but you may find the same *common name* on all of them.

Labels on containers are like people; some are orderly and fairly easy to understand, while others are so complicated that it takes a great deal of effort to figure them out. But all labels will have the basic information you need, because this is required by law. This section will explain all the items that must be on a label. You should be thoroughly familiar with them.

Next, let's look at *labeling*. This is the word used to describe all other information that you receive about the product. Labeling includes such things as brochures, flyers and information handed out at the point of sale. This material must not differ in meaning from the information the manufacturer gave to EPA when the product was registered for use.

Ingredient Statement

Every pesticide label must list the ingredients in the product. The statement is divided so that you can quickly see what the active ingredients are. The amount of the *active ingredient* usually is given as a percentage. It can be listed by either the chemical name or the common name. For example, 1-naphthyl N-methylcarbamate has been given the common name carbaryl. The *inert ingredients* need not be identified except by the percent of the formulation they make up.

Net Contents

The net contents number tells you how much is in the container. This can be expressed in gallons, pints, pounds, quarts or other units of measure.

Name and Address of Manufacturer

The law requires the manufacturer of a product to put the name and address of the company on the label. This is so you will know where to call for information in case of an emergency.

Registration and Establishment Numbers

You should look for two numbers on every container of pesticides. One is a registration number which shows that the product has been registered with the federal government. It usually is found on the front panel, and will be written as "EPA registration No. 0000-00." The other is an establishment number that identifies the factory which produced the chemical. The law says that both these numbers must be on every pesticide label.

If you use a product that has not been registered, you will be breaking the law. So be sure to look for these numbers before you buy.

Warnings and Precautions

To be effective, pesticides must kill or reduce the target pest. By their nature, they must be toxic to some degree. You can tell the hazards of a product by reading the *signal words, symbols, and environmental warnings* on the label.

Signal words: One of the most important parts of the label is the *signal word*. It tells you how toxic the material is. The signal words that follow are set by law and each manufacturer must use the correct one on every label.

Signal Words	Toxicity	Approx. Amount Needed To Kill the Average Man When Taken by Mouth
DANGER/POISON	Highly Toxic	A taste to a teaspoonful
WARNING	Moderately Toxic	A teaspoonful to a tablespoonful
CAUTION	Low-Order Toxicity	An ounce to a pint
NO WARNING OR CAUTION STATEMENT	Comparatively Free from Danger	More than one pint

All products must bear the statement "Keep Out of Reach of Children."

Symbols: One of the best ways to catch a person's eye is with pictures or symbols. This is why a skull and crossbones symbol is used on all highly toxic materials along with the signal word **DANGER**.

In addition, some product labels use other symbols to warn people against drinking, spilling or breathing the toxic material.

Pay attention to the symbols on the label. They are there to help you remember that the contents could make you sick, or even kill you.

Environmental warnings: Chemicals, such as insecticides, herbicides, and fungicides, can be useful tools. But improper or careless use can cause bad results instead of good ones. To help keep this from happening, the label contains environmental warnings that should be read and followed.

Here are some examples of environmental warnings:

- "This product is highly toxic to bees exposed to direct treatment or residues on crops."
- "Do not contaminate water by cleaning of equipment or disposal of wastes."
- "Do not apply where runoff is likely to occur."

In the future, labels may contain more generalized warnings against exposing bird, fish and wildlife.

Antidotes and First Aid Instructions

If the material is hazardous, the label will give emergency first aid measures, statements about symptoms of poisoning, and a note to the physician. The pesticide label is the most important information you can take to the physician when a person is suspected of being poisoned.

PRECAUTIONARY STATEMENTS
DANGER
HAZARDS TO HUMANS (& DOMESTIC ANIMALS)

HAZARDS TO HUMANS (& DOMESTIC ANIMALS)

Poisonous by swallowing or inhalation. Do not breathe spray mist. Do not get in eyes. Avoid contact with skin. Wear a mask or respirator of a type passed by the U. S. Bureau of Mines for De Pesto protection. For emergency assistance call 000-000-0000

TO PHYSICIAN: De Pesto is a reversible cholinesterase inhibitor. Do not use oximes such as 2-PAM. Give Atropine 2mg. intravenously or subcutaneously. If in eye instill one drop of Homatrophine.

ENVIRONMENTAL HAZARDS

This product is toxic to fish, birds and other wildlife. Birds feeding on treated areas may be killed. Keep out of any body of water. Do not apply where runoff is likely to occur. Do not apply when weather conditions favor drift from areas treated. Do not contaminate water by cleaning of equipment or disposal of wastes. This product is toxic to bees and should not be applied when bees are actively visiting the area.

PHYSICAL OR CHEMICAL HAZARDS

WARNING - Flammable! Keep away from heat or open flames.

PRECAUTIONARY STATEMENTS
DANGER
HAZARDS TO HUMANS (& DOMESTIC ANIMALS)

ENVIRONMENTAL HAZARDS

PHYSICAL OR CHEMICAL HAZARDS

DIRECTIONS FOR RESTRICTED USE

RE ENTRY STATEMENT

CATEGORY OF APPLICATOR

STORAGE AND DISPOSAL DIRECTIONS

RESTRICTED USE PESTICIDE
FOR RETAIL SALE TO AND APPLICATION ONLY BY

STATEMENT OF PRACTICAL TREATMENT

IF SWALLOWED - Induce vomiting by giving a tablespoonful of salt in a glass of warm water. Repeat until vomitus is clear. Call a physician immediately.

IF INHALED - Remove to fresh air. Call a physician immediately.

IF IN EYES - Flush eyes with plenty of water for at least 15 minutes. Call a physician immediately.

IF ON SKIN - In case of contact, remove contaminated clothing and immediately wash skin with soap and water.

SEE SIDE PANEL FOR ADDITIONAL PRECAUTIONARY STATEMENTS

KEEP OUT OF REACH OF CHILDREN
DANGER - POISON



STATEMENT OF PRACTICAL TREATMENT

SEE SIDE PANEL FOR ADDITIONAL PRECAUTIONARY STATEMENTS

MFG BY A Z CHEMICALS
TOWN, STATE
ESTABLISHMENT NO. 00475
EPA REGISTRATION NO. 1367-02

DIRECTIONS FOR RESTRICTED USE CONTINUED

NET CONTENTS ONE GALLON

Classification of Uses

Every pesticide label must show whether the contents are for general use or restricted use. EPA puts every product into one of these two classes. Several things are considered before classifying a pesticide use. They include:

- the toxicity of the pesticide,
- the way in which it is used, and
- its effect on the environment.

General use: The section on laws and regulations stated, you remember, that if a pesticide will not harm the environment to an unreasonable degree when carried out exactly according to directions, it can be classified as general use.

The label will identify general uses with this statement in the directions for use: "General use pesticides — available to the public."

Restricted use: A restricted pesticide use, you recall, is one that could harm the environment or the applicator even when used as directed. The

The use instructions will tell you:

- in what form the product should be applied; for example, whether it must be incorporated or diluted in water;
- how much to use for each acre, square foot or other unit of measure;
- where the material should be applied; and
- when it should be applied.

Anytime you fail to apply a pesticide according to the directions on the label, you will be violating the law. Be sure you read and understand the use instructions for every chemical you use.

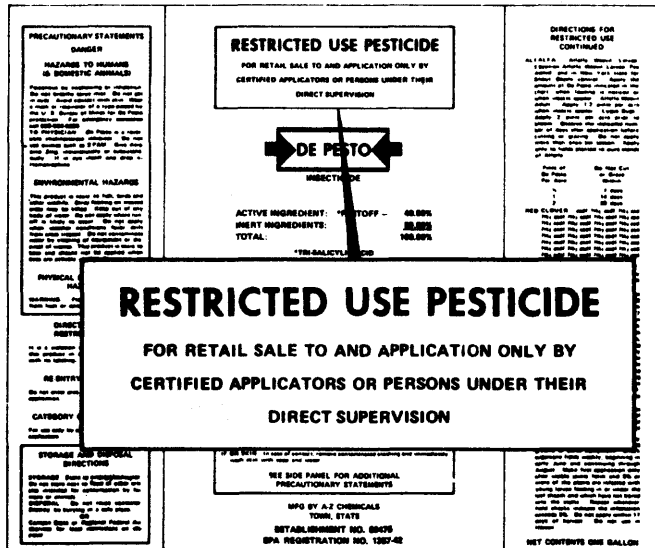

TARGET PEST AND DOSAGE

Before you use any pesticide, you should read the label to find out:

1. whether the product is effective for the pest you want to control (the target pest), and
2. how much of the product (what dosage) is needed to control the target pest.

Do not use a product on a crop or for a pest not listed on the label, and do not use more than the recommended dosage. Before the product could be registered, EPA required the manufacturer to conduct many tests to be sure these directions were correct. By following them exactly, you will:

- get the best results the product can give, and
- avoid violating the law.

label identifies restricted uses this way: "Restricted use pesticide for purchase and use only by certified pesticide applicators or by persons under their direct supervision." Sometimes the label will limit the use of the product to certain categories of commercial applicators. The restricted use statement must appear at the top of the front panel.

Use Instructions

The instructions on how to use the pesticide are the most important part of the label for you, the applicator. This is the only way you can find out how to apply the product correctly to control the pest that is causing the problem.

Penalties

Remember, you will be breaking the law any time you do not follow any of the directions on a pesticide label. As the section on laws and regulations explains, you may receive a civil penalty of up to \$5,000 even though you did not intend to break the law. Anyone who knowingly misuses a pesticide is guilty of a criminal offense and on conviction could be fined up to \$25,000 and imprisoned for up to one year.

It Pays to Follow Label Directions.

Self-Help Questions on Section 2 – Labels and Labeling

Now that you have studied Section 2, answer the following questions. Write the answers with pencil without referring back to the text. When you are satisfied with your written answers, see if they are correct by checking them with the text.* Erase your answer and write in the correct answer if your first answer is wrong. Note that these questions are not necessarily those that are used in the certification examination.

1. What is a label?
2. What is meant by labeling?
3. What is a brand name?
4. What is a common name?
5. What is an active ingredient in a pesticide formulation?
6. Match the following signal words:
 - a. Danger/Poison 1) Low order toxicity
 - b. Caution 2) Highly toxic
 - c. Warning 3) Moderately toxic
7. What does the symbol of the skull and crossbones indicate about the toxicity of a pesticide?
8. What is meant by an environmental statement on a pesticide label?
9. Should you take the pesticide label to the medical doctor in case of suspected poisoning from the pesticide?
10. What is meant by a restricted use pesticide?
11. Can a pesticide legally be applied for some use not cited on the label?
12. What is meant by a target pest?

*The questions are arranged in the order that they appear in the text.

SECTION 3: Types of Pesticides

A *pesticide* is a chemical substance or mixture of substances used to destroy, prevent, or control a pest. Pesticides also include:

- substances or mixtures of substances used to regulate, defoliate, or desiccate plant growth, and
- substances or mixtures of substances used to attract or repel pests.

Insecticide: a pesticide used to control insects and other related joint-legged animals such as ticks, spiders, centipedes, sow bugs and pill bugs.

Miticide or Acaricide: a pesticide used to control mites.

Nematicide: a pesticide used to control nematodes (nemas).

Fungicide: a pesticide used to control fungi.

Bactericide: a pesticide used to control bacteria.

Herbicide: a pesticide used to control weeds.

Rodenticide: a pesticide used to control rodents.

Avicide: a pesticide used to control birds.

Piscicide: a pesticide used to control fish.

Molluscicide: a pesticide used to control mollusks, slugs, snails and barnacles.

Plant Growth Regulator: a pesticide used to stop, speed up or in any way modify normal plant processes.

Defoliant: a pesticide used to remove unwanted plant growth.

Desiccant: a pesticide used to kill plant foliage to make harvest easier.

Repellent: a pesticide used to divert a pest from a crop, animal, product, or structure.

Attractant: a pesticide used to lure a pest to a location.

2. Plant-derived organic pesticides, extracted from plants or plant parts; some common plant-derived organic pesticides are rotenone, red squill, pyrethrins and strychnine.



3. Synthetic organic pesticides; man-made pesticides containing carbon, hydrogen, and several other elements such as chlorine, phosphorous, and nitrogen; examples of synthetic organic pesticides are: 2, 4-D, atrazine, captan, parathion and carbaryl.

THE CHEMICAL NATURE OF PESTICIDES

Pesticides can be grouped according to their origin. These are:

1. Inorganic pesticides, or mineral origin; the more common elements used to make inorganic pesticides are arsenic, copper, boron, mercury, sulphur, tin and zinc.



HOW PESTICIDES WORK

- **Protectants:** pesticides applied to plants, animals, structures and products to prevent pest establishment.
- **Sterilants:** pesticides applied to control pests by rendering them incapable of normal reproduction.
- **Broad-spectrum pesticides:** chemicals that reduce loss due to two or more pests of a particular crop. They are sometimes labeled multipurpose disease control chemicals. A material capable of controlling scab, powdery mildew and mites on apples, for example, is broad-spectrum in its action. This category of pesticides is somewhat more general than the others since a broad-spectrum pesticide may be a protectant, eradicant or systemic in its action.
- **Contacts:** pesticides that kill pests simply by contacting the pest.
- **Systemics:** pesticides that are moved within the animal or plant to kill the pest without harming the host animal or plant.
- **Fumigants:** pesticides which kill the pests by giving off a gaseous vapor.

Many of the synthetic organic pesticides work in one or more of the above listed ways. Read the pesticide label to find out how the pesticide you use works.

TYPES OF FORMULATIONS AND PRINCIPLES IN USE

An active ingredient can rarely be used as originally manufactured. It is usually mixed with other substances to make it convenient to handle and safe, easy and accurate to apply. When the active ingredient is put into a mixture, we call it a pesticide formulation. A formulation is made up of active and inert ingredients. The final pesticide formulation is ready for use, either as packaged or diluted with water or other carriers.

Liquids

Emulsifiable concentrates (EC or E): An emulsion is one liquid dispersed, usually as very small drops, throughout another liquid. An emulsifiable concentrate, EC, is a liquid formulation of a pesticide which can be mixed with another liquid to form an emulsion. EC's usually contain two to six pounds per gallon of active ingredient. Water is the usual liquid EC's are mixed with, but some EC formulations are made to be added to oil or other petroleum carriers. Many pesticide active ingredients are not soluble in water, but are soluble in some oils or other solvents. In EC's the active ingredient is dissolved in an oil or solvent, and emulsifying agents and other adjuvants are added to the formulation so that the EC can be mixed with water to form a "milky" emulsion. The emulsion then can be conveniently sprayed. Little agita-



tion in the spray tank is normally required when using EC's.

When EC's are combined with other products, special mixing, agitation, or compatibility agents may be needed to prevent separation. Some crops are sensitive to EC's and may require a different formulation, such as wettable powder or a dust.

High concentrate liquids, spray concentrates: These formulations may be thought of as special EC formulations. They usually contain a high concentration of the active ingredient, often eight or more pounds per gallon. Most are designed to be mixed with water and oil. They contain chemicals that allow the formulation to wet, spread, and stick well. Ultra-low-volume (ULV) concentrate materials are designed to be used directly without further dilution and they may contain only the pesticide itself.

Low concentrate liquids: These formulations contain low amounts of the active ingredient and are usually solutions prepared to be used as purchased with no further dilution. This type of formulation is most often used for controlling household pests, mothproofing, or as a livestock spray or a space spray in barns.

Flowables (F or L): Some active ingredients can be manufactured only as a solid, or at best, a semisolid material. They usually have relatively low solubility in water or other organic solvents. These pesticides are often formulated as flowable liquids. The active ingredient is very finely ground and suspended in a liquid along with special suspending chemicals and additives. In this form the formulation can be mixed with water and applied.



Flowables seldom clog spray nozzles and require only moderate agitation. They usually handle as well as an EC formulation.

Solutions (S): Some active ingredients are completely soluble in water or organic solvents and in their original state they are liquids. The pesticide is formulated in an appropriate solvent or water and exists as a true solution or in a molecular state. Solutions, if properly prepared for special uses, do not leave unsightly residues. They will not clog spray equipment. Some formulations of this type damage crops. Where this is a problem, other formulations will have to be used.



Aerosols: The active ingredient is in a formulation in a can under pressure. One or more pesticides may be in the same formulation. The propellant drives the formulation out through a fine spray opening. The percentage of active ingredient is usually very low in aerosols. Convenience of use is the major advantage. Aerosols are mainly used in the garden and home, occasionally in greenhouses and barns, and seldom in commercial agriculture. In addition to pressurized aerosols, there are thermal and mechanical aerosols which are used in special situations.



Pressure liquefied gases: Some active ingredients are gases in their natural form. When placed under pressure in a container some still remain as a gas, but many of them become a liquid. This type of formulation is stored under pressure (high or low depending upon the product). When applied, it usually is injected directly into the soil, or released under tarps, or into a vessel such as a grain storage elevator. Some types of nematocide, fumigant and rodenticide materials are examples of this type of formulation. Applicators *must* be certified in the fumigation specialty before they may apply restricted use classified pressure liquefied gases.

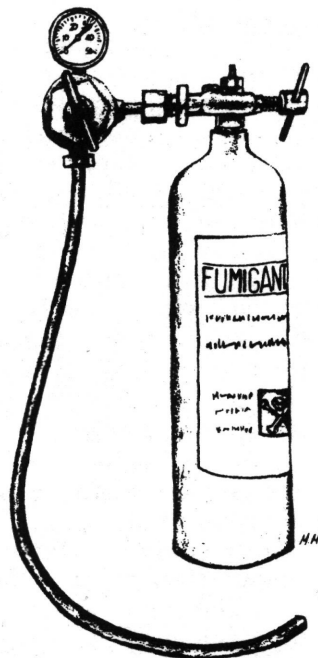

Some liquid formulations, not requiring storage under pressure, turn to a gas or vapor after they are applied to the soil or crop. If the formulation is an insecticidal chemical it may depend on the vapors of the active ingredient to do most of the pest killing. In herbicide products, the liquid must be incorporated into the soil before it turns to a gas. Otherwise, it could be lost to the atmosphere.

Dry

Dusts (D): A dust formulation usually consists of the active ingredient mixed with an inert material such as a talc, clay, powdered nut hulls or volcanic ash in concentrations ranging from 1-10 percent. All the ingredients are finely ground to a fairly uniform particle size range. Adjuvants are often added so that the formulation will store well and handle properly. Some active ingredients are prepared as dusts because they are safer for crops in this form.

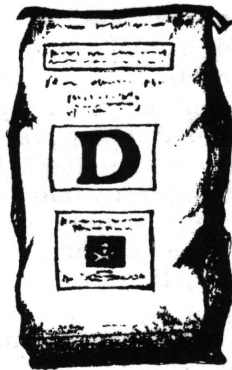

If they were EC's they might injure the crop. Dusts are always used dry and should never be mixed with water. The very small particles in dusts make them subject to drift into nontarget areas during application. Always apply them carefully. Never apply them under windy conditions. Dust formulations are available for use on seeds, plants and animals. For vertebrate animal control, dusts can be applied in small patches or burrows so the animals come in contact with them. The animals are killed as they swallow the pesticide while cleaning their feet and fur.

Granules (G): Granular formulations are dry formulations, usually made by applying a liquid formulation of the active ingredient to particles of clay or other porous materials such as corn cobs or walnut shells. The granule carrier is prepared in advance to a standard size and then the liquid formulation is added. The liquid added ingredient is absorbed into the granules, or coats the outside of the granules, or both. Other materials may be added to make the formulation handle well. The percentage of active ingredients in a granular formulation ranges from 2-40 percent. Granular formulations are safer to apply than EC's or dusts. They are most often used as soil treatments. They may be applied either directly to the soil or over plants. They do not cling to plant foliage, but they may be trapped in the whorls of some plants.



Wettable powders (WP or W): These are dry powdered pesticide formulations that look like dusts. But, unlike dusts, they contain wetting and dispersing agents. Wettable powders are usually much more concentrated than dusts, containing 15-95 percent active ingredient (most WP formulations have a concentration of active ingredient greater than 50 percent). They are made to mix with water, and when mixed they form a suspension. Good agitation is needed in the spray tank to keep the formulation in suspension since it does not form a true solution. Some pesticide products can be prepared as wettable powders but not as EC's because of the nature of the active ingredient. Properly prepared wettable powder formulations spray well and do not clog nozzles, but may be abrasive to pumps and nozzles. Most wettable powder formulations are less likely to damage plants than EC formulations. Wettable powders and EC's are the formulations most widely used.



Soluble powders (SP): Soluble powders, like wettable powders, are dry formulations. But when soluble powders are added to water, they will dissolve and form true solutions. Agitation in the spray tank is sometimes required to get them into solution but after that no more agitation is needed. The percent of active ingredient in an SP is usually above 50 percent. Not many SP formulations are available.



Poisonous baits: A poisonous bait formulation is a pesticide mixed with water, food or other attractive substance. The attraction of the bait base and/or the placement of the bait convenient to the target animals causes them to eat enough pesticide to cause their death. Bait formulations are useful in controlling mice, rats and other rodents. They also are used to control ants, flies and other insects. Whole areas or simple spot treatment can be done with bait formulations. Baits can be used in buildings and outdoors. The percentage of active ingredient in bait formulations is quite low, usually below 5 percent.

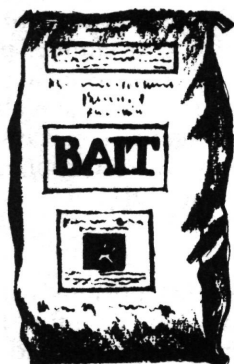

INSECTICIDES

Studies of biological control of insect pests which reduce the yield and quality of Michigan's crops are intensively underway. Until these methods can be perfected, insecticides will continue as a major means of protecting these crops from insect attack. There are hazards and wastes associated with insecticides if used indiscriminately or without precaution. Therefore, applicators must completely understand insecticides, equipment and the means of their safe and proper use. Suggestions on the use of insecticides for insect control appear periodically in the recommendations issued by the Michigan Cooperative Extension Service. The recommendations are, of necessity, brief and are written with the assumption that the applicator is familiar with insecticides and their use. When a new or major insect problem necessitates the use of chemicals on a crop that previously required little protection, the applicator may have limited knowledge and familiarity with the insecticides. The following discussion on the different types of insecticides, formulations, and methods of handling and application is designed to increase your knowledge about pesticides and encourage their discrete and proper use.

Insecticides are chemicals used to limit insect numbers on food and fiber crops, on man and animals and inside and outside of dwellings. While their use is primarily against insects, "insec-

ticides" are often used on pests other than insects (such as mites, spiders, ticks, and centipedes). Generally, insecticides have specific activity against a certain group of insects or mites and may be relatively ineffective against others. It is imperative that you recognize this fact and understand the different characteristics of the chemicals classified as insecticides. The insecticide recommendations from the Extension Service are based on definite testing to establish which chemical, at which rate of application gives the desired results against the target pest. Remember, such recommendations will more than likely change from year to year in response to newer, more effective chemicals and procedures.

In the past insecticides were classified on their mode of entry into the insects; such as stomach, fumigant, or contact poison. However, with the development of the modern insecticides, which may act in a combination of ways upon an insect, such classification no longer holds. Classification is now based upon the chemical nature of the insecticide. These categories are: (1) organic chemicals of plant or animal origin; (2) inorganic chemicals; (3) synthetic organic chemicals; (4) fumigants; (5) repellents and attractants.

Organic Chemicals

These chemicals occur in nature in plants, animals or, as in the case of oils, as a result of the breakdown of plants and animals. Included in the plant organic group are nicotine, rotenone and pyrethrum. They are rapidly broken down by sunlight, leaving little toxic residue. Many of these compounds have contact, stomach and fumigant actions and are commonly employed in aerosol sprays to produce rapid knockdown of the insects. Petroleum oils, upon refinement, are commonly used as contact insecticides, acaricides (against mites) and ovicides (against the egg) and are applied both during the dormant and growing period of plants. In general, oils suffocate the insect, mite or egg by covering it with a thin film which prevents normal exchange of oxygen.

Biological insecticides, naturally occurring diseases of the insects, can also be used for insect control. The best known are the bacterial disease agents *Bacillus thuringiensis* and *B. popillae*. Such diseases are specific to a certain insect species, break down rapidly upon exposure to light and leave little or no harmful residues. These diseases are applied as a spore suspension to the plant part where the insect feeds in order to ensure the ingestion of the spores. Once ingested, the spores paralyze the gut of the insect preventing further feeding and eventually they invade other parts of the insect's body.

There are other types of "biologicals" such as fungi, virus and nematodes which are being studied for controlling insects.

Inorganic Chemicals

The inorganic chemicals are effective solely as stomach poisons. Lead arsenate, Paris green, sulfur and sodium fluoride are examples of stomach poisons receiving much use in the past. Their potential for insect control is questionable when compared to the more efficient synthetic organic chemicals.

Synthetic Organic Chemicals

This is by far the most important group of insecticides now available for pest control. They can be separated according to their chemical makeup into the following groups:

Chlorinated hydrocarbons: These chemicals are characterized by their long residual properties important in long-term insect control such as for termites, grubs and wood boring insects. Included in this group are DDT, dieldrin, chlordane, lindane, endrin, methoxychlor, BHC and others. Because of their persistence and the tendency to accumulate in fat and in nontarget organisms, their use is being limited to essential uses where less persistent alternative chemicals are not available. Their toxicity to humans ranges from quite toxic (endrin) to relatively safe (methoxychlor) but in general are less toxic in man than the organic phosphates. The chlorinated hydrocarbons should be limited for those essential uses where a less persistent alternative is not available.

Organic phosphates: Unlike many of the chlorinated hydrocarbons, the organic phosphate insecticides are, in general, more acutely toxic in man. They have a short residual life, being broken down by exposure to sunlight, heat and water. They affect the nervous system of animals and kill insects by contact, fumigation and stomach poisoning. Examples of the organic phosphates include parathion, malathion, Guthion, diazinon, TEPP, ethion, Vapona and other pesticides. Certain organic phosphate insecticides exhibit systemic action in plants and animals. This ability to be absorbed and translocated into the plant sap or the blood stream of animals increases their efficiency for pest control. Some systemics presently available are dimethoate, Thimet, Di-Syston and Meta-Systox-R. The organic phosphates do not accumulate in body tissues like the chlorinated hydrocarbons but can reduce the levels of cholinesterase (an important chemical of the nervous system) upon repeated exposure.

Because of their short residual life and quick action against insects, the organic phosphates have been and will continue to be used extensively in all aspects of agriculture. These materials must be handled with extreme care because of their inherent toxicity to man.

Carbamates: The carbamates are nerve poisons, like the organic phosphates. Many carbamates are of recent development and show a wide range of

variability in toxicity and residual life. Some of the more commonly used carbamates include Sevin, Matacil, Baygon, Ficam, Furadan, and Temik. The carbamates show considerable range in toxicity from safe (Sevin) to extremely toxic (Temik). They also exhibit variability in action including stomach, contact and systemic properties. Residual properties of most carbamates exceed many of the organic phosphates, hence their use as residual treatments is often employed.

Dinitrophenols: The dinitrophenols are extremely toxic to man and are harmful to many plants. Therefore, they are most commonly employed as dormant sprays. They are especially effective against mites, scales and aphids when applied during the period of plant dormancy. Their action is primarily as a contact poison against insects but they are also used against mites, plant diseases and weeds. They have also been used as a blossom thinning agent on certain fruit trees. Some of the more common dinitrophenols are Elgetol, Kremite, DNOC and DHC.

Fumigants

These are gaseous poisons used to kill insects and other organisms in a confined space. Their use is limited to warehouses, railroad cars, soil inhabiting insects and nematodes and to products enclosed in gas type wrappings or tents. They are commonly used to eliminate insects in stored grain products. Some common fumigants include methyl bromide, hydrogen cyanide, carbon tetrachloride, carbon disulfide and others. They are hazardous to employ because of the danger of accidental poisoning to man or other animals and also because of the flammability of certain gases.

Attractants and Repellents

The principal use of repellents has been against mosquitoes, biting flies, fleas, ticks and chiggers which attack man and animals. Indalone, diethyl toluamide, ethyl hexanediol, dimethyl carbamate and others have been employed for use on man. Livestock repellents include dibutyl succinate, and butoxy polypropylene glycol.

Attractants are compounds used for sampling populations and luring insects to traps or poison bait, or away from crops, or for reducing the repellent properties of certain sprays. Compounds used in attractants include molasses, sugar, siglure, yeast extract, geraniol, sex pheromones and others. While the use of attractants has been employed sparingly in insect control they are often quite specific, thus providing a selective weapon against the target species.

FUNGICIDES

Fungicides, chemicals designed for the control of plant disease caused by fungi, are the usual means of controlling plant diseases in the field,

greenhouse and storage. Some fungicides are toxic to most kinds of fungi while others are specific to only a few species.

Most fungicides are used as protectants; they are applied to plant surfaces before the fungus arrives and provide a barrier to infection. A few are eradicans or disinfestants; they are applied after the fungus has begun to invade the leaves, fruit and stem. They may kill the fungus inside the plant or prevent it from sporulating and spreading. The disinfestant type fungicides are used primarily to clean storage areas before use.

Fungicides are used in many ways. The largest quantity is used as sprays or dusts. They are used both by the urban backyard gardener and by the professional agriculturalist. Direct treatment of seeds, tubers, bulbs and roots by the nurseryman or seed distributor is another important use of fungicides. Some fungicides are designed to be used in the soil as fumigants or to be mixed directly into the plant soil.

Hundreds of chemicals have been used for the control of fungus diseases. They are classified, however, into two groups: the inorganic and the organic types. The two main inorganic fungicides are copper and sulfur compounds. Although these chemicals were used almost exclusively for disease control before World War II, they have been generally replaced by the organic fungicides. In many cases, the new compounds are less injurious to plants than were the inorganics.

Inorganic Fungicides

Copper compounds: Bordeaux mixture has been used for nearly 100 years for disease control. Consisting of soluble copper sulfate mixed with hydrated lime in water, it is used as a spray. The lime safens the mixture and improves control by sticking the copper onto the plant.

The "fixed" or "insoluble" copper compounds have generally replaced Bordeaux mixture for disease control. There are several fixed copper products available, containing either basic copper sulfate, basic copper chlorides, copper oxides, or various other formulations. They are used as sprays or dusts for the control of certain fungal and bacterial diseases.

Sulfur compounds: Sulfur was the first known fungicide and is still used extensively today for the control of certain foliage and fruit diseases. Sulfurs are known particularly for their effectiveness in controlling powdery mildews. They are used as dusts or as sprays. Although several formulations of sulfur exist, they fall into three types — wettable sulfur, sulfur paste and lime-sulfur. The wettable sulfurs are the most common types used today. Lime-sulfur, a special mixture of hydrated lime and sulfur, was used extensively for insect and disease control at one time, but today, like sulfur paste, is decreasing in importance.

Mercury compounds: Mercury, both inorganic and organic forms, was used extensively as a fun-

gicide for seed treatment and to a lesser extent as a foliar spray until recent years. Due to their possible contribution to mercury contamination of the environment and their toxicity to humans and animals, mercury compounds have been suspended for use as fungicides. Organic fungicides have essentially replaced the mercuries.

Organic Fungicides

Carbamates: Development of the carbamate fungicides was a major breakthrough in fungicide chemistry. Because of their value to mankind in preserving food and fiber, the discovery of the carbamate fungicides is comparable to the discovery of DDT as an insecticide. These compounds are still used throughout the world to control a variety of diseases on many crops.

The carbamate fungicides are all derivatives of dithiocarbamic acid, an organic acid used in vulcanizing rubber. They are classified into three groups: (1) *The thiuram disulfides*. These are sold under many trade names such as Thiram, Arasan, Tersan, Thylate, etc. and are known by the common name of thiram. They are used for seed and bulb treatments, against certain foliage diseases, particularly the rusts, and as soil-drenches for damping-off and seedling blight. (2) *The dithiocarbamates*. Ferbam and ziram are the important members of this class. Although they are not used as much today as in the past, they are still used to some extent for the control of certain foliage diseases on vegetables, ornamentals and fruit trees. (3) *The ethylene bisdithiocarbamates*. Nabam, zineb, and maneb are important members of this class. They are used extensively on vegetables for the control of several diseases and also on flowers, turf and fruit crops. Like the dithiocarbamates, each of these chemicals contains a metal such as sodium, zinc, iron or manganese.

Quinones: Several quinones have been tested as fungicides but only two, chloranil and dichlone, have been developed for use commercially. Chloranil, the first of the organic fungicides, is used primarily as a seed protectant and is sold under the trade name Spergon. It has limited use as a spray or dip treatment. Dichlone is used as a foliar and fruit protectant on fruit and certain other crops. It also has some use as a seed protectant. Dichlone is sold as Phygon, Phygon XL, etc.

Benzene compounds: There are several fungicides in this chemical class but most of them are relatively specific in the pest they control or in how they may be used. Dexon and pentachloronitrobenzene (PCNB or Terraclor) are used primarily for the control of soil-borne diseases. Dinocap is specific for powdery mildew and is sold under the trade name of Karathane or Mildex. Dichloran or Botran prevents decay of fruit crops caused by Rhizopus, a common bread mold. It is used as foliar spray or soil fungicide on vegetables, flowers, and fruit or as a postharvest treatment on certain fruit and vegetables. Daconil is a relatively new

compound for use on vegetables and certain other crops. It differs from the other benzene compounds in being effective against a spectrum of foliage and fruit pathogens.

Heterocyclic compounds: There are two groups of the compounds.

1. **Benzimidazoles.** The benzimidazoles are systemic fungicides and include thiabendazole (TBZ) and benomyl. These compounds are in the early stages of development commercially, having been registered to date on only a few crops. They are particularly effective against the ascomycete fungi, a group that includes a large number of plant pathogens. Benomyl appears to be active at slightly lower rates than thiabendazole. Because they are systemic, there is a great hope that they will be effective against internal pathogens and less subject to weathering. Since they are translocated to the new growth, new leaves or shoots should be protected.
2. **Trichloromethylmercapto compounds.** This group includes three closely related fungicides — captan, folpet, and difolatan. Captan was the first to be developed. It is used for the control of a large number of fungus diseases of fruits, vegetables, and ornamentals in foliage, seed, and soil applications. Folpet and difolatan have similar properties and are used where they are more effective than captan. Difolatan is known particularly for its ability to resist weathering and provide extended control.

Guanidines: The main fungicide in this class is dodine. Sold under the trade name of Cyprex, it is used for the control of foliage diseases of apples, cherries, strawberries and roses. It is used primarily as a protection but is also a good eradicant against apple scab.

Antibiotics

In addition to the two major groups of fungicides (organic and inorganic) antibiotics may also be included as a lesser group of fungicides. Antibiotics are chemical substances produced by microorganisms which are toxic to other microorganisms. Penicillin, produced by the fungus *Penicillium notatum*, is an example of an antibiotic widely used in human medicine.

Cycloheximide is an antibiotic active against fungi. It has been used for the control of turf diseases, cherry leaf spot and powdery mildews. Although it was used extensively at one time, it has generally been replaced by synthetic organic fungicides. Certain others are used for control of plant diseases.

HERBICIDES

A large number of chemical weedkillers are now available. Selective control of weeds in crops may be obtained by either foliage sprays (post-emergence) or application of the chemicals to the

soil either as preplanting or preemergence sprays.

Factors such as rainfall, soil type and method of application influence herbicide effectiveness. Use herbicides on only those crops for which they are specifically approved and recommended.

Chemicals may be used for selective control of weeds in tolerant crops and nonselectively for control of annual and perennial species in noncrop areas.

Important Terms Used in Weed Control

- A weed is a plant growing where it is not desired or a plant out of place.
- Herbicides can be defined by their effects on plants; *contact, growth regulators, and soil sterilants.*
- Contact herbicides kill plant parts covered by the chemical. Contact herbicides may be (1) selective or (2) nonselective; they are usually nonselective.
- A *selective herbicide* kills or stunts some plants with little or no injury to others.
- A *nonselective herbicide* is toxic to all plants.
- Growth regulators are also called *growth modifiers, growth substances, translocated herbicides, and systemic herbicides.* They can be absorbed by the leaves, stems or roots and are translocated through the plant system affecting the physiological system of the plant.
- A soil sterilant is any chemical which prevents the growth of green plants when present in the soil. Length of time of residual toxicity is an important factor in their use.
- Preplanting treatment is any treatment made before the crop is planted.
- Preemergence treatment is any treatment made before emergence of a crop.
- Broadcast treatment or blanket application is uniform application to an entire area.
- Spot treatment is treatment of a restricted area, usually to control an infestation of a weed species requiring special treatment.
- Surface active agents include wetting agents, emulsifiers, detergents, spreaders, sticking agents and dispersing agents. Water is not compatible with many chemicals used as herbicides, or with many plant surfaces. Surface active agents produce more uniform mixing of herbicides and water in the sprayer and better coverage of the weeds.
- Active ingredient is that part of a chemical formulation directly responsible for the herbicidal effect.

Factors Affecting Foliar Applied Herbicides

Applying herbicides to plant foliage is a direct means of getting the chemical to the plant. Many factors influence the movement into the plant and the responses vary. More consistent results are obtained and variability may be explained if these factors are known.

Proper application: Rate of herbicide is important and therefore uniform application is necessary. (Perhaps uniform distribution is not as important as in soil applications especially in the use of systemic type herbicides.) Uniformity of concentration and delivery rate is essential; therefore, correct nozzles, sprayer speed, agitation, pressure and dilution are important.

Interception by leaves: Leaf angle, degree of hairiness, expansion, and leaf area-dry weight ratio will influence response. In annuals, the greatest leaf area-dry weight ratio is in the seedling stage. In perennials, the greatest ratio occurs later so treatment should be delayed until considerable growth has developed. A canopy of leaves can be a deterrent to effective control or a safeguard against injury. Wetting conditions will affect interception by changing leaf orientation and reducing leaf area.

Retention: Keeping spray droplets on the leaf is an important consideration once contact with the leaf has been made. Type of leaf surface such as waxy coating, pubescence, or roughness will affect retention. Use of wetting agents and other materials that will lower surface tension, nonpolar formulations (esters) and low spray volumes will increase retention.

Rainfall will cause runoff if it occurs shortly after or during application. With many herbicides, one to two hours after application without rain will allow for penetration. Herbicides will also volatilize from leaf surfaces when exposed to high temperature.

Absorption: This phenomenon varies with each herbicide, formulation, plant species, and environmental factor. Thickness of the cuticle (waxy coating) has a direct relationship. Uniform leaf coverage is essential to maximum penetration. Penetration may be both an active and a passive process. High humidity, high soil moisture and conditions that favor rapid growth increase absorption. Stomata that are open may be an avenue of entry for volatile herbicides and ones of low surface tension.

Translocation: Downward movement is through the phloem (living tissue) and is favored by production of assimilatory material and growth processes. Herbicides tend to move to regions of activity such as buds, young leaves, seed, storage organs and meristematic areas. Excessive application rates or contact injury will reduce translocation and is a factor to consider in herbicide combinations. In a few cases, herbicides have recycled in a plant. Movement out of the plant roots or excretion of herbicides has been shown under certain conditions. This will reduce the amount available to the plant and plant response will be altered accordingly.

Activation and deactivation: Some herbicides (2, 4-DB) are activated by an enzyme system after entering the plant (β -oxidation) while others (at-

razine in corn) are deactivated by being metabolized or complexed with cell constituents such that it is not available to exert phytotoxicity. The rate or degree of degradation is influenced by conditions affecting plant growth, i.e., temperature, sunlight, soil moisture.

Accumulation: The rates of absorption and translocation affect accumulation. Accumulation at the sites of action, generally meristematic regions, varies with species and rate of degradation at these sites. Environmental factors that influence metabolism and other mechanisms at the site of action will influence plant response.

Cellular sensitivity: Ultimate response of a plant to a herbicide is at the cellular level. Susceptibility will vary during the season and with the season. Maturing plants develop varying levels of tolerance. Mature tissues or those of low metabolic activity will show little response to a concentration that would have been injurious at an earlier stage of growth.

Factors Affecting Soil Applied Herbicides

Many factors may have an effect on the movement of the soil applied herbicide to the site of action. A knowledge of these factors involved in the transfer of a herbicide from applicator, through the soil, and to the plant is helpful in obtaining more consistent responses or to help explain some of the variability.

Proper application: The use of the specific rates of application is essential. Very small amounts are necessary to inhibit plant growth. However, sufficiently high rates must be used to compensate for the amount lost to the soil and is otherwise unavailable for uptake by the plants. Rates must not be of the magnitude to cause crop injury or soil residues.

Uniformity of distribution over the sprayed surface is important. Nozzles must have a uniform delivery, a uniform spray pattern, even spacing and proper height to give uniform coverage. Water volume is not important if there is a constant concentration and uniform distribution. Constant pressure and speed are necessary. Granulars present a greater problem in obtaining uniformity.

Soil interception: An even uniform surface, free of clods, manure, plant litter and other debris will provide a good distribution pattern. Spray droplets will cover the upper surfaces of clods and not beneath while granulars will fall in depressions. Granular formulations again present a greater problem on uneven surfaces.

Physical movement: Wind and water (excessive rainfall) will cause runoff or movement from treated areas. Movement will be to depressions and cause increased concentrations in these areas. Some leaching into the soil is necessary for effective control. Incorporation properly carried out will benefit some herbicides but may cause variable

concentration or placement too deep. Band applications are lost when untreated soil is moved in by cultivation.

Volatility: This is a major form of loss for certain herbicides. High soil temperatures and air movement increase volatility losses. Damp or wet soil at time of application causes additional losses through water vapor distillation in some cases and through keeping the herbicide concentrated in the exposed surface layer as water moves to the surface. Incorporation reduces volatility losses.

Photodecomposition: Many herbicides are broken down by exposure to light, especially the ultraviolet. Losses will occur when herbicides remain on the soil surface for extended periods.

Solubility: Movement into the soil is related to solubility; therefore, salts will move more readily than wettable powders. Additional rainfall is needed to get wettable powders into the upper one-fourth to one-half inch of soil.

Movement in soil: Water transport provides for the greatest amount of herbicide movement in soil. This occurs primarily when there is sufficient water to exceed field capacity. Diffusion in soil water is important only in vicinity of roots. Diffusion in soil gases plays a part if herbicide is quite volatile. Greatest movement is downward; however, some lateral and some upward movement occurs. Movement varies greatly in different soil types.

Degradation: Breakdown of the chemical is by chemical and biological processes. Temperature, aeration, pH and other soil factors will affect chemical processes such as hydrolysis and oxidation. The degradation by micro-organisms is one of the major means of herbicide loss from soil. Organisms may be specific for a particular herbicide and the numbers will increase when repeated applications are made. Conditions that favor growth of micro-organisms will speed breakdown.

Absorption: This is the means of entry into the plant. It is favored by conditions that favor high transpiration rates. Amount of root system exposed is important since amount of herbicide absorbed is generally proportional. A heavy plant population may reduce amount absorbed by any one plant as well as concentration of herbicide in the soil.

Adsorption: A great deal of variability exists in the amount of herbicide adsorbed by soil since soils vary in organic matter and inorganic soil colloids. Organic matter adsorbs more strongly and thereby greatly reduces the amount of chemical available and also retards movement in soil. Randox (CDAA) is an exception in that it is more effective in high organic matter soils.

Translocation: Upward movement is primarily in the xylem (nonliving tissue) and concentration is in areas of most rapid water loss. Rather high concentrations of herbicide can be moved since living tissue is not involved once the chemical reaches the vascular system.

Activation and deactivation: Some herbicides (such as 2, 4-DB) require activation either in the soil or plant. Other herbicides may be deactivated in the plant by metabolism or modification. Active and inactive metabolites or complexes may be formed. Selectivity may be obtained by these processes.

Accumulation: There is a threshold concentration of phytotoxicity. Amount taken in must be greater than amount degraded or eliminated. Conditions that affect absorption, translocation and degradation will also affect the accumulation of toxic concentrations.

Cellular sensitivity: Plant response is due to sensitivity to a certain concentration of chemical. Species vary greatly as to tissues within a plant. Environmental conditions and tissue maturity play an important role. Mature tissue generally shows less activity and older plants are less likely to be killed.

NEMATICIDES

Chemical soil treatment offers the most promising means of nematode control at this time. Nematode-toxic chemicals can be brought into contact with the nematodes by mechanical dispersal through the infested soil, percolation in water or a gaseous diffusion of a nematicidal fumigant through the pore spaces of the soil. To kill nematodes, chemicals must enter their bodies. This penetration may occur through the cuticle, through body openings or by ingestion during nematode feeding. However, several of the new nematicides apparently reduce nematode activity by suppressing their feeding and/or reproduction rather than actively killing them.

Complete eradication of soil-borne parasitic nematodes through soil application of nematicides is impractical for field conditions. The objectives of such treatment are to reduce nematode populations to a level where serious crop damage will not result. Complete eradication is obtainable, however, on limited volumes of soils, such as in greenhouses and seedling production.

Nematicides are generally used as a preventive measure. By the time nematode damage becomes apparent, the infested crops are usually injured so severely that control measures are ineffective in increasing yields. Therefore, control procedures are normally based on preplant or time-of-planting application.

Soil Fumigants

Fumigants are used to reduce infestation of soil-borne nematodes, fungi, insects and weed seeds. Due to the cost of the chemicals and treatment, the use of soil fumigants has been restricted to high-value crops (for example, potatoes, fruit trees, strawberries, muck crops, ornamentals, nursery beds, greenhouse soils, and other specialty

items). The cost and operation of fumigation equipment is another deterrent to the widespread use of soil fumigation. Most soil fumigants are injected as liquids into the soil where they volatilize to gas and diffuse through the soil mass. The soil must be sealed immediately following an application using a drag, roller, water or polyethylene tarp to maximize the effectiveness of the material. Such things as soil porosity, soil moisture, temperature and organic content of the soil influence control. (See general discussion of fumigants.)

Nonfumigant Nematicides

Contact nematicides are not fumigants, and will not give satisfactory results if applied by fumigant methods. Nonfumigant nematicides must be applied, mixed into, and/or carried by water into contact with the nematodes.

Nonfumigant nematicides may be applied either before planting and/or at time of planting. When such chemicals are used, care must be taken to plant the seeds in the treated portion of the soil. Possibility of injury to germinating seeds and seedlings is usually minimal when these materials are used correctly.

Chemically, nonfumigant nematicides are generally either organic phosphates or carbamates. As with chemically similar insecticides, these nematicides are nerve poisons which are acutely toxic to man and should be handled with care.

INCOMPATIBILITY OF CHEMICALS

A single application of a pesticide for the control of a particular pest has long been an established practice. Knowing that the actual application of the pesticide is in many cases more expensive than the cost of the chemical, many commercial applicators have gone to mixing chemicals in the spray tank. This, in effect, gives them the "shot gun" approach in an attempt to control more than one pest problem with a single application.

Such a practice is not without its problems. Sometimes these problems are serious and more costly than if the chemicals had been applied alone. There is no question that product mixing requires more knowledge of pesticide formulations, timing of application and application techniques than the one-chemical, one-problem approach.

When discussing the problem of product mixing, the first question that arises is, What is the compatibility or incompatibility of the products involved? In simple terms, we are concerned whether the mixtures can be used in combinations without changing the toxicity, physical properties or plant safety of either of the components.

There are five major areas of incompatibility that should be considered before an attempt to mix products is undertaken.

Physical Incompatibility

This comes about when two or more pesticides are mixed together and the result is an unsprayable mixture. Several conditions might develop here such as excessive foaming, curdling, and a gummy deposit at bottom of the spray tank. Hard water can also cause some physical incompatibilities. In some cases physical incompatibilities can be recognized in the spray tank before the mixture is sprayed.

Problems of physical incompatibilities can often be checked out by mixing small batches of the mixtures in the same proportions and agitating them in a closed container.

Chemical Incompatibility

This type of incompatibility comes about when the pesticides are mixed and the effectiveness of one or all of the compounds is reduced or destroyed. The most common of this type of incompatibility comes about when materials with a high pH (such as lime) are added to the mixture.

Chemical incompatibility is not evident in the spray tank. Before combining any pesticides, check with labels, product information sheets or company representatives for information on this type of compatibility problem.

Phytotoxic Incompatibility

This takes place when product mixtures cause injury to plants sprayed with the mixture. This can happen even though each of the pesticides in the mixture, when sprayed separately, does not cause injury.

As with chemical incompatibility, check all information on the pesticides for any warnings about this type of incompatibility. If in real doubt, spray a small amount on a few plants and observe the effect, being sure to give injury enough time to show up.

Placement Incompatibility

Even though the mixing of two or more chemicals to control different pests may save time in application, the spray operator must be sure that the chemicals are going to be placed where they will be effective. A good example of this type of incompatibility would be the mixture of a turf fungicide with an insecticide to control grubs in the turf. The fungicide needs to be deposited on the leaves on the turf, but the soil insecticide needs to be drenched into the soil where the soil grub comes in contact with the chemical.

It is essential that the applicator understand the type of problems or the results can be a waste of chemicals and ineffective treatments.

Timing Incompatibility

Pesticides used in spraying must be applied when the stage of development of the pest is best controlled. With many insects, diseases or weeds,

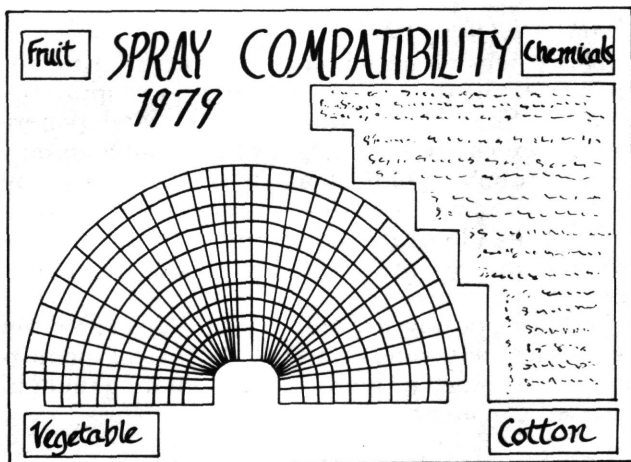

this may be a relatively short period. It is of utmost importance when using two or more chemicals to control different pests that the mixtures be applied at the correct time in the life cycles to be effective.

The application of a herbicide to control lawn weeds is best done in spring when the growth is tender and readily susceptible. The addition of an insecticide for the control of lawn moths that appear in July and August would be a worthless combination at this time.

This has been a brief summary of the problems of pesticide compatibility. With the application of any pesticide, thorough knowledge of the pests to be controlled is essential and the combinations of pesticides and pests require even greater knowledge. Consult all available sources before going into these combinations.

RESIDUES AND TOLERANCES

A pesticide residue is that part of a chemical remaining, after application, in or on a location. Most residues of a treating operation will be in the target location. Poor application methods and wrong target selection can result in high residues in non-target areas.

It should be remembered that equipment **MUST BE ADJUSTED** to apply pesticides so that the residues remain only where they are wanted. Drift usually results from poorly adjusted equipment or from too high winds.

Pesticide formulations also affect residue de-

posits. Formulations determine how tightly the residue (deposit) sticks to the plants in the field. Indoors, some kinds of formulation can be used on some kinds of wood and not on others.

The following examples will help you to further understand pesticide residues:

1. When one pound of insecticide is mixed with 100 gallons of water and sprayed over the foliage of an acre of potato vines, **THAT PART OF THE INSECTICIDE ADHERING TO THE FOLIAGE IS THE RESIDUE OF THE SPRAYING OPERATION.** This residue may be only 60 percent of the actual pound of insecticide. Other parts of it could have been deposited on the soil, or drifted away in the wind.
2. The residue problem is especially complicated in the control of household and industrial insect pests. Three primary conditions of the problem exist:
 - **Residues of smell.** These are the results of the nature of the chemicals or the result of formulations.
 - **Residues of contact.** These normally arise from overspray of the chemical(s), thus exposing people to unnecessary residues.
 - **Residues of water contamination.** The possible contamination of wells **MUST BE CONSIDERED** when applying pesticides to control termites, ants and other insects in and around foundations.
3. Pesticide registration is designed to **REGULATE** residues. The pesticide label determines:
 - The effective amount that will control the target insect or other pests. This amount will vary according to the kinds of insects, disease, weeds, size of the crop, air temperatures and the natural effectiveness of the pesticide.
 - The safe level of the residues on food and feed products. The amount of residue is expressed in parts per million. Other problems, such as soil and water contamination, are much more difficult to solve.

In order to get the desired results and yet stay within the required tolerance levels (ppm), use all pesticides according to label instructions. Products on the market are registered for use. This registration takes into consideration safe and proper application and residue levels. The instructions to protect you from dangers of application are also on the package labels and should be followed closely.

Self-Help Questions on Section 3: – Types of Pesticides

Now that you have studied Section 3, answer the following questions. Write the answer with pencil without referring back to the text. When you are satisfied with your written answers, see if they are correct by checking them with the text.* Erase your answer and write in the correct answer if your first answer is wrong. Note that these questions are not necessarily those that are used in the certification examination.

1. Is a plant growth regulator classed as a pesticide?
2. What is an example of an inorganic pesticide?
3. Is pyrethrin a pesticide derived from plants?
4. What are some synthetic organic pesticides?
5. Where can you find out how the pesticide that you are using works?
6. Why are pesticides usually sold as formulations rather than as pure pesticide?
7. Give some examples of liquid formulations of pesticides.
8. What is a "flowable" formulation?
9. Are aerosol formulations commonly used indoors for pest control?
10. What types of pesticides are available as pressure liquefied gases?
11. Should dust formulations be mixed with water for use?
12. What is a common use for granular formulations?
13. What is the difference between a wettable powder and a soluble powder?
14. Where can you obtain recommendations on the use of insecticides?
15. Give some examples of organic insecticides.
16. Is lead arsenate a stomach or contact poison?
17. In what part of the body does DDT accumulate?
18. What is meant by "systemic action" of an organic phosphate insecticide?
19. What type of insecticide is Sevin?
20. Where are dinitrophenol type insecticides commonly used?

*The questions are arranged in the order that they appear in the text.

21. *Why are fumigants considered hazardous?*
22. *What are attractants used for in insect control?*
23. *How does an eradicant type fungicide work?*
24. *Name some chemicals that are used as inorganic fungicides.*
25. *Name some types of organic fungicides.*
26. *What is an antibiotic?*
27. *Is a postemergence application of a herbicide the same as a foliage application?*
28. *What is meant by a "nonselective" herbicide?*
29. *What is needed to assure proper application of a herbicide?*
30. *Is leaf area to dry weight ratio of the weed important to the effectiveness of herbicides?*
31. *How does the leaf surface affect the action of herbicides?*
32. *What conditions favor absorption of a herbicide by a plant?*
33. *What is meant by translocation of a herbicide?*
34. *Do mature plant tissues show less or greater response to a concentration of herbicides?*
35. *Is the volume of water sprayed as important as uniformity of application with soil herbicides?*
36. *Does incorporation of a soil herbicide increase volatility loss of the herbicide?*
37. *What causes degradation (breakdown) of herbicides?*
38. *What effect does soil organic matter have on soil herbicides?*
39. *Is complete eradication of soil nematodes practical in the field?*
40. *In what state (liquid, solid, or gas) are most soil fumigants applied to the soil?*
41. *Should nonfumigant nematicides be applied as foliar applications?*
42. *What does the term incompatibility mean with reference to mixtures of pesticides?*
43. *Where can you find information on the compatibility of pesticide mixtures?*
44. *What is meant by a pesticide residue?*
45. *Where can you find information on the use of a pesticide so that the required tolerance for that pesticide will not be exceeded?*

SECTION 4: Application Equipment

METHODS OF APPLICATION

Pesticides can be applied in a variety of ways. Some common types of applications used in Michigan:



1. *Sanitary sprays* (crack and crevice treatments) are applications of pesticides in buildings. They are used to kill pests, such as cockroaches, stored products insects, or millipedes, that take shelter in cracks and corners. In grain storage areas, sanitary sprays are especially recommended in wooden bins, the boots of grain handling equipment, or other places that cannot be swept clean of the debris that harbors the insects. Crack and crevice treatments may also be painted on with a brush.
2. *Spot treatments* are used where pests appear in localized areas. Some common situations in which spot treatments might be utilized are weeds in lawns, fungus diseases on turf, or nematodes in a corner of a field.
3. *Broadcast soil application* is the coverage of the soil of the entire field with spray or granules prior to planting. Broadcast soil applications should be made just before the final disking or dragging of

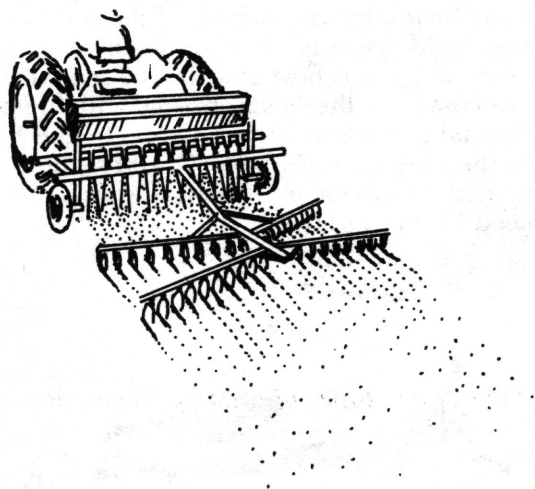

the field. The final fitting operation will incorporate the insecticide into the upper surface of the soil

4. *Furrow application* is the placement of an insecticide in a narrow line in the soil below and to the side of the seed at planting time. Granular insecticides are usually used for this type of application and the insecticide may be dropped into the fertilizer row.
5. *Soil band application* is the placement of spray or granular materials in a band centering over the row of the crop leaving an area between the rows untreated. The chemical is usually placed above and out of contact with the seed and is covered with soil immediately after application. Soil band applications can be made at the time of planting or they can be applied after plants have emerged if special equipment is available to apply and cover the material.

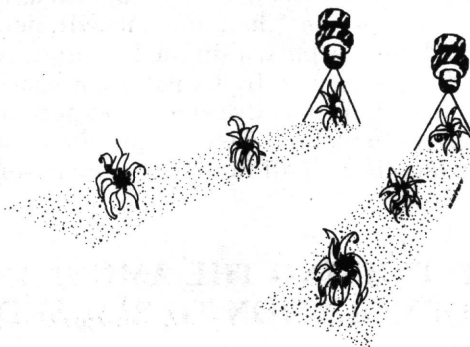

6. *Foliage sprays, granular applications, or dusts* are applications to the plant itself. This type of application can be made either as a broadcast-type to cover the entire field or as a directed

application to cover only the row of plants. The broadcast type is usually done on small grains and hay crops while the directed application is usually done to concentrate the insecticide on the plants grown in rows.

7. *Seed treatment* is coverage of the seed with an insecticide prior to planting. Treating seed with an insecticide is best done by the seed dealer at the same time the seed is treated with fungicide. Special dust formulations of insecticides for use by the grower are available. Use these dusts when a seed treatment is needed and ready-treated seed is not available.

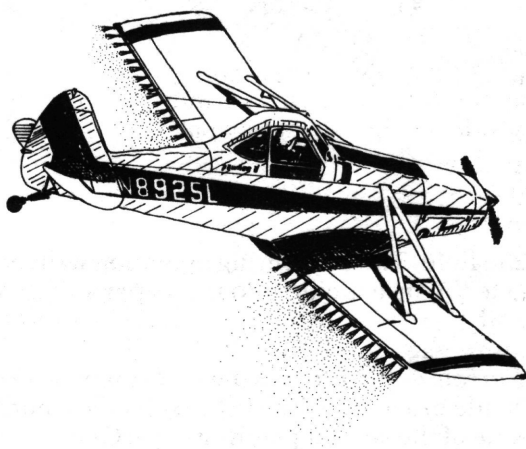

8. *Aerial applications* usually involve sprays, but granules or dusts may also be used. Aerial applications are especially desirable to large plants or trees over an extensive area or when damage would be done by a tractor-drawn rig. Most aerial sprays are applied at the rate of from 1 to 5 gallons of spray per acre. Ultra-low-volume (ULV) or concentrate aerial sprays can be used against some pests.
9. *Fumigation* is the application to buildings, stored grain or soil, of insecticides as gases or as liquids that will vaporize. The fumigants will penetrate and kill the insects within the building, grain or soil. Fumigation is, by its nature, a hazard and should be done only by someone experienced in the use of fumigants. Two people should always work together on all fumigation operations.

DETERMINING THE AMOUNT OF FORMULATION TO BE USED

The amount of pesticide to be applied per acre is given in the recommendations as the pounds or ounces of active ingredient to be applied. The amount of formulated pesticide will have to be calculated for the formulation that the grower will use. This calcula-

tion for dust, granular, and wettable or soluble powder formulations can be made using the equation:

$$\text{ounces or pounds of formulation} = \frac{100R}{P}$$

where **R** is the recommended amount of active insecticide in pounds or ounces and **P** is the percentage of active ingredient in the formulation. For example, if 1½ pounds of active ingredient is recommended (**R** = 1.5) and an 80 percent wettable powder is used (**P** = 80):

$$\text{pounds formulation} = \frac{100 \times 1.5}{80} =$$

1.88 pounds (1 lb., 14 oz.).

The calculation of liquid flowable or emulsifiable concentrate formulations can be made using the equation:

$$\text{pints formulation} = \frac{8R}{P}$$

where **R** is the recommended amount of active ingredient, in pounds, and **P** is the pounds of active ingredient per gallon of formulation. For example, if 1 pound of active ingredient is needed (**R** = 1) and an emulsifiable concentrate containing 5 pounds of active ingredient per gallon is used (**P** = 5):

$$\text{pints formulation} = \frac{8 \times 1}{5} = 1.6 \text{ pints}$$

(about 26 liquid oz.).

The dust and granular formulations are applied directly without water. The amount of formulation of a granule or dust needed to give the recommended amount of active ingredient should be determined first and the equipment then calibrated to deliver exactly that amount of formulation. Wettable powders, flowables and emulsifiable concentrates are mixed with the spray water. The amount of these formulations needed to obtain the recommended amount of active ingredient per acre or per gallon should be calculated and added to the amount of spray delivered per unit by the sprayer.

Recommendations for the amount of ingredient to be applied per acre are sometimes given as pounds per acre even though the ingredient is applied only as narrow bands across the field. The amount applied per acre may be independent of the width of the rows. At times, such as band applications for rootworm control in corn, the recommendation is given for a specified row width and adjustment in the amount of actual ingredient must be made when some width other than the specified row width is used. This adjustment is made using the equation:

$$\text{pounds per acre} = \frac{RW}{V}$$

where **R** is the recommended amount of insecticide in pounds, **W** is the specified row width in inches, and **V** is the row width in inches that will be used. For example, if 1 pound of active insecticide (**R** = 1) for a

40-inch row is recommended ($W = 40$), and a row width of 30 inches is to be used ($V = 30$):

$$\text{pounds per acre} = \frac{1 \times 40}{30} =$$

1.33 lb. (about 21 oz.).

Some recommendations for pesticides are given as the amount of pesticide (as either active ingredient or as a formulation) to be mixed with a specified volume of water. The amount to be used in some volume of water other than the volume of water specified can be calculated using the equation:

$$\text{amount to be used} = \frac{RV}{W}$$

where R is the recommended amount of pesticide, V is the volume of water to be used, and W is the volume of water specified. For example, if 2 pounds of a 15 percent wettable powder is recommended ($R = 2$) per 100 gallons of water ($W = 100$), and 250 gallons of water is to be used ($V = 250$):

$$\text{amount to be used} = \frac{2 \times 250}{100} =$$

5 pounds of 15% wettable powder.

APPLICATION EQUIPMENT

Sprayers

Select a sprayer, regardless of size, on the basis of the jobs for which it is intended. It must operate adequately while subjected to the abrasion of wettable powders and the deteriorating effect of some formulations on holes, seals, tanks, etc. So, durability as well as convenience in filling, operating, and cleaning is required.

Small capacity sprayers: are used mainly for small jobs such as home and garden pest control and in restricted areas unsuitable for larger units. There are seven major types of small capacity sprayers.



1. **Compressed air sprayers** are commonly used for spraying shrubs, lawns, gardens, buildings, and small farm jobs. These are hand-carried and usually hold from 1 to 5 gallons of formulation.



2. **Back-pack sprayers** are carried on the back, leaving both the operator's hands free to direct the nozzle, change the spray pattern, etc. They may carry up to 5 gallons of formulation. Back-pack sprayers are used on garden crops, in greenhouses, on farms and orchards, and for mosquito control.
3. **Garden hose sprayers** are operated by pressure from the water system. They usually hold about a gallon of chemical, which is diluted by the flow of water from the hose. They are popular for lawn and garden use.

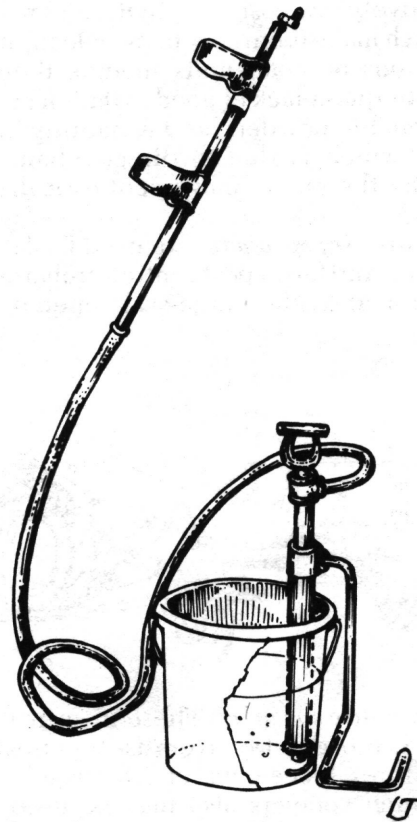

4. **Bucket, or trombone, sprayers** take two hands to operate: one to operate the pump, and the other to direct the spray. Uses are similar to those of a compressed air sprayer.

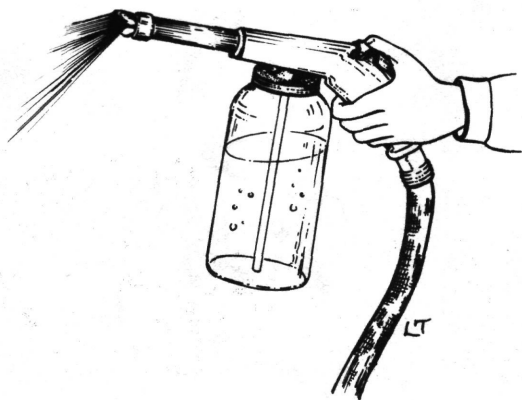

5. *Hand pump sprayers* consist of a push-pull hand pump and a canister of spray material. They are used mainly for household insect control, or for spraying home gardens and shrubs.
6. *Trigger pump sprayers* are small hand-held units useful for spraying houseplants or for other spot treatment applications. Most, like hand pump sprayers, hold 1 quart of chemical.
7. *Aerosols* may be sealed containers of compressed gas and pesticides. They are usually of less than 1 quart capacity and are generally too expensive to be practical for any uses other than home and garden.

The advantages of all of these small sprayers are their relatively low cost, simplicity, and maneuverability which make them easy to use, clean, and store.

Limitations of small units include their limited capacity, frequent lack of good agitation and screening for wettable powders, and variability in application rate, which is due to direct reliance on the operator for the rate of movement over the target.

Large-capacity sprayers: are used for farm operations, for turf and forest pest control, orchards, aquatic pest control, and other large-scale operations.

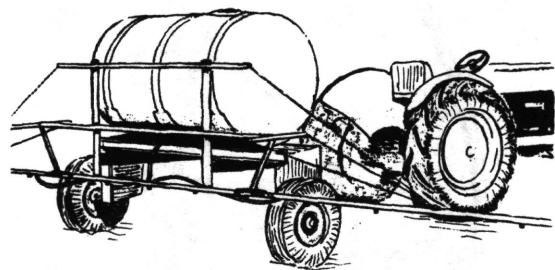

1. *Low-pressure sprayers:* These are primarily boom or boomless broadcast sprayers used for treating field crops, pastures, fence rows, etc., for weed and insect control. Such sprayers also may be used to apply liquid fertilizers or fertilizer-pesticide mixtures.

The advantages of these sprayers are: (1) their high capacity, which is due to the use of low amounts of water or other carrier per acre, medium to large tanks, and speeds of 4 mph and above; (2) their low fixed and

operating costs per acre; and (3) their relatively light-weight, inexpensive, multi-purpose design. High clearance sprayers permit spraying tall rowcrops, and flotation tire equipped sprayers permit spraying during wet field conditions.

Some limitations are: (1) the low gallonage will not permit adequate coverage for some fungicides, insecticides and defoliant; and (2) the limited pressure may reduce penetration of heavy foliage or of heavy coats of hair on livestock.

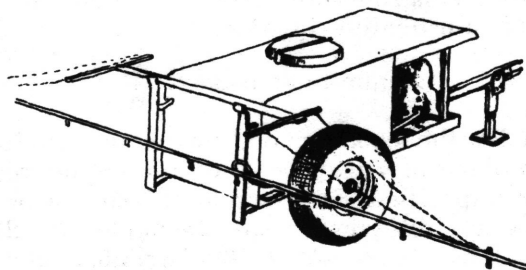

2. *High-pressure sprayers:* Often termed hydraulic sprayers, these machines are used to spray fruits, vegetables and trees for disease and insect control. They are also used for spraying ornamentals and livestock and to wash equipment. When fitted with the proper pressure regulators, they can be used at low pressures. Applications are usually made at high gallonages (100 or more per acre), so even though large tanks are used, they still require frequent filling.

Advantages of these units are that they (1) can do about any type of spray job, (2) are well constructed and long-lived if properly maintained, (3) usually have good mechanical agitation, (4) are designed to last even with use of wettable powder pesticide formulations.

Limitations of high-pressure sprayers are the high initial and operating cost, large amounts of water needed, high power and fuel needs, high tire loads, and high spray pressures which can result in formation of large numbers of small drops subject to drift or in misdirected spray carrying to the wrong targets.

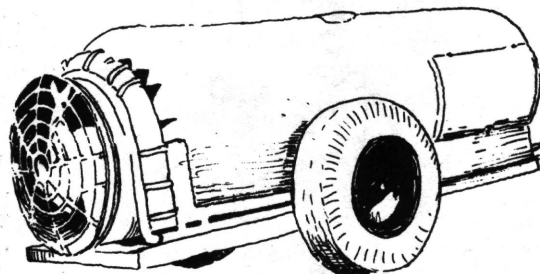

3. *Air blast sprayers:* With these units, a stream of air is used to carry the pesticide spray particles to the target. Although dependent on the nozzles and formulation used, the high-velocity air stream usually breaks for nozzle output into the fine drops which move with the air. The air is directed into the trees of the orchard or across the field crops such as vegeta-

bles to either one or both sides as the sprayer moves forward. Rates of application are low (often called concentrate spraying).

Advantages, in addition to spraying many acres per tankful, are: (1) good coverage and penetration, (2) high work capacities, (3) lighter weight units, lower pump pressures, and greater ease of operation than the high-pressure sprayers.

Limitations are (1) the hazards of drift and poor patterns under windy conditions, (2) chance of overdosages, (3) the addition of a blower increases the complexity of the unit and raises the power and fuel requirements and the initial cost, and (4) that it is very difficult to treat small areas without contaminating surrounding areas.

4. *Mist blowers*: These sprayers are really specialized air blast sprayers with higher air velocity and lower air volume than regular air blast sprayers. As a result, the spray is finer and the application rate is lower. They are used not only on fruits and vegetables, but also for shade tree spraying, space spraying and mosquito control. They use even less water, so operating costs can be kept low.

Limitations are the increased problems from drift and pattern breakup in windy conditions, difficulty in getting good coverage and proper swath widths, and the need for more careful calibration.

5. *Ultra-low-volume sprayers*: Spraying the undiluted pesticide at rates of $\frac{1}{2}$ gallon per acre or less is called ULV spraying. ULV spraying may be done by aircraft or ground rigs. If done by ground, air streams may be used to help break up and direct the spray. The advantages are the high capacities and lower cost made possible by eliminating all water. The disadvantages are the increased risk of drift and overdosage and the limited number of pesticides judged suitable for such application.

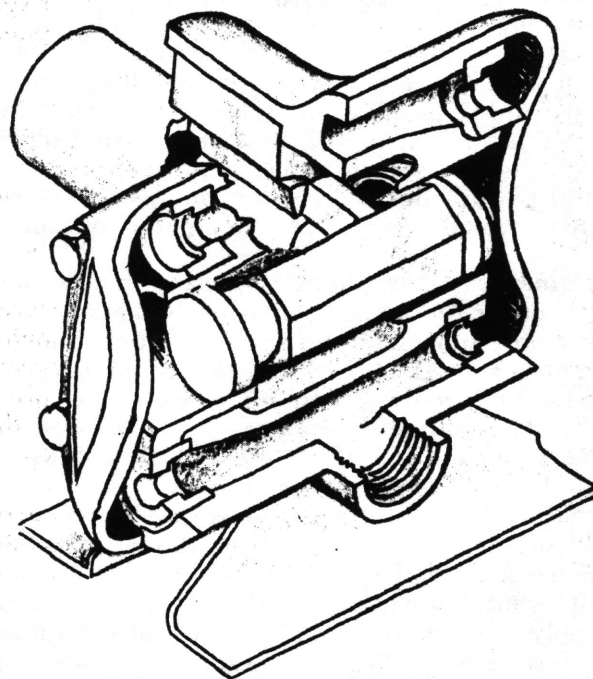
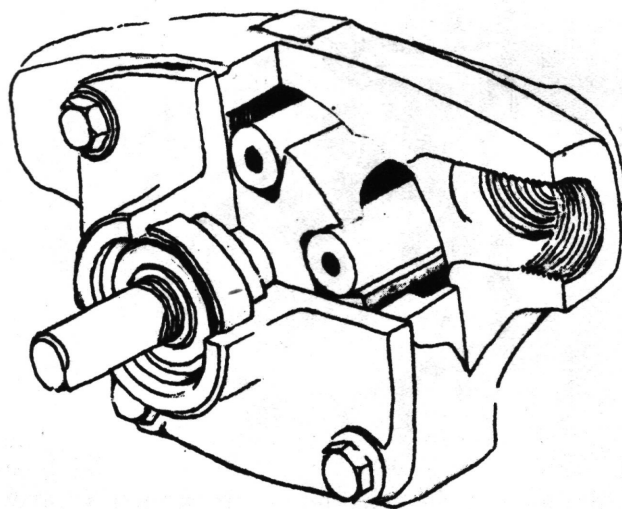

Components of Sprayers and Their Maintenance

Tanks: Tanks of any capacity should have large filling openings for easy filling and cleaning. Straining during filling, and mechanical or hydraulic agitation should be provided. The tank should be corrosion resistant either by being of stainless steel, plastic or glass-reinforced plastic, or by having a protective lining or coating. It should have a good drain and outlets sized to the pump capacity. If dual tanks are used, make sure plumbing is designed to permit agitation and adequate withdrawal rates from each tank. The tank should have a liquid level gage to permit checking rate of use and indicate when refilling is necessary.

Pumps: The pump must provide enough flow over the range of spraying pressures to supply all nozzles, hydraulic agitation if used, plus a reserve to allow for loss of flow due to wear. All pumps should be corrosion resistant. For low-pressure

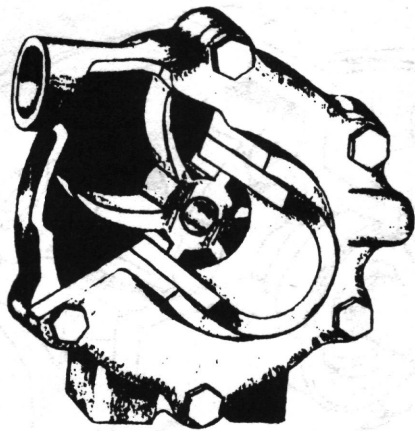

field sprayers, the maximum output should be at least 0.3 gallon per minute per foot of swath exclusive of agitation requirements. (See agitation section below.) Centrifugal pumps are becoming more popular because they provide enough additional flow at fairly low cost for good agitation of 200-gallon and larger tanks. Piston and diaphragm pumps are self-priming, and roller and gear pumps are self-priming at low suction heads; centrifugal pumps are not self-priming. If pressures above 75-100 psi are desired, piston pumps are more likely to provide them over a long period of time.

Strainers: Proper filtering of the pesticide not only protects the working parts of the sprayer but also avoids time loss and misapplication due to clogging of nozzle tips. Filtering should be progressive with the finest filtering nearest the nozzles. A 12 to 20 mesh strainer should be used in the tank opening and a 25 to 40 mesh strainer used in the suction line to the pump if it is not a centrifugal pump. Centrifugal pumps should not have a suction line strainer. Use a line strainer of 40 to 50 mesh with wettable powders and of 80 to 100 mesh for other mixtures. Smaller nozzle sizes used to apply low volumes per acre may also require nozzle screens of 80 to 100 mesh. Nozzle sizes so small that 200 mesh screens are needed are not recommended.



Hoses: Select synthetic rubber or plastic hoses that have burst strength greater than the peak operating pressures, resist oil and solvents present in pesticides, and are weather-resistant. Suction

hoses should resist collapse and be larger than pressure hoses. (See Table 1.) All fittings on suction lines should also be large.

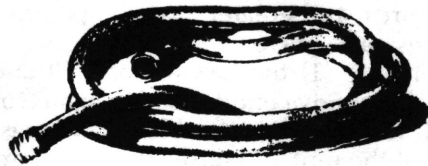
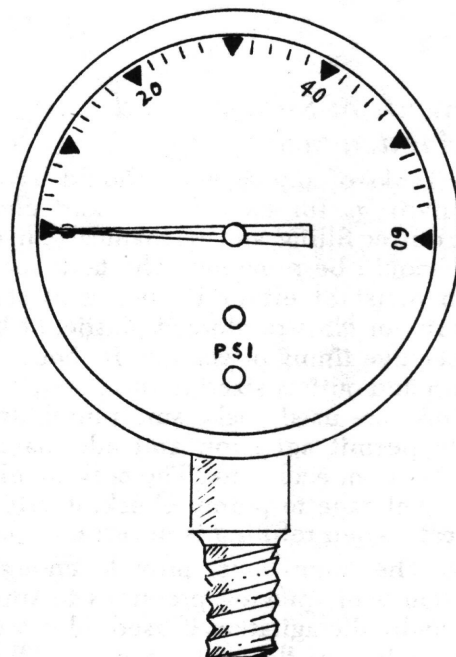

TABLE 1. Typical Hose Sizes for Various Flow Rates

Hose Type	Flow Rate in gallons per minute						
	4	8	12	20	40	60	120
Pressure Hose Size (Inches)	½	¾	¾	1	1¼	1½	2
Suction Hose Size (Inches)	¾	¾	1	1¼	1½	2	2½

Pressure gages: These serve as the monitor of your spraying operation. They should be accurate and have only the range needed for your operation. For example, 0-60 psi with 2 pound gradations would be enough for most low pressure sprayers. Any unindicated pressure change results in misapplication, so place at least one gage where it reads boom pressure and is protected from surges when valves are closed.



Pressure regulators: As with pressure gages, select a regulator whose range compares well with the range of operating pressure you plan to use. Make sure it is large enough to handle the bypass flow expected when the spray lines are closed and to prevent pressure from being too high when low nozzle pressures are desired.

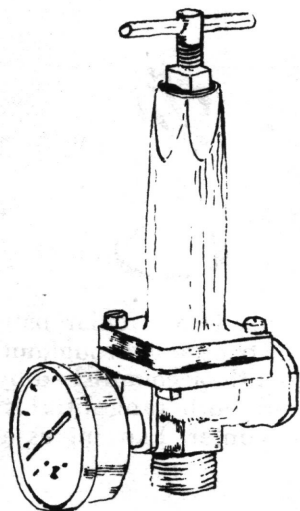

Agitation: Make sure your sprayer has adequate agitation or your actual pesticide application rate may vary greatly as the tank is emptied. Mechanical agitation is the surest means of getting good agitation but is expensive initially and harder to maintain. Bypass agitation may be sufficient for solutions and emulsions but for wettable powders a separate jet agitator should be used. The bypass type of hydraulic agitation uses the return flow from the pressure relief valve to agitate the liquid in the bottom of the sprayer tank. The jet agitator type is attached to the pressure side of the pump to operate at nozzle pressure or above which gives it much more energy for agitation. The jet outlets are fixed on a pipe in the bottom of the tank to discharge horizontally across the bottom of the tank. The jet agitator size must be selected to leave enough flow for the nozzles and a reserve for wear. For tanks holding 200 gallons or more multiple jet agitators or a pipe with holes drilled every foot should be used.

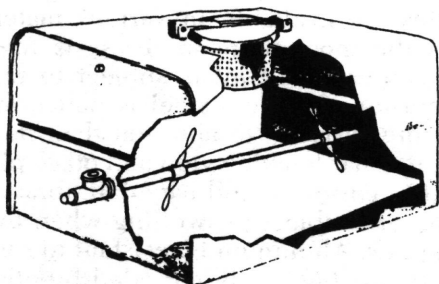

If bypass agitation is used, bypass flow equal to 25 percent of tank capacity is needed to mix wettable powders adequately. Jet agitators can do the job at 5-10 percent of tank capacity.

Control valves: These should be large enough to restrict flow and should be accessible to the operator. On-off action should be quick and positive with the capability of cutting off all flow or flow to any section.

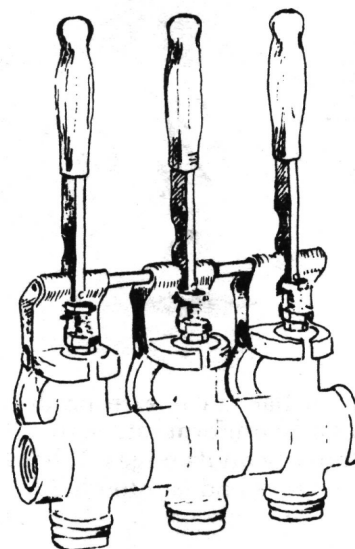

Safety: Valves, hoses and fittings should be located and/or shielded so operator is not likely to be hit by liquid if bursts or leaks occur.

Nozzles: The nozzle helps control the rate, uniformity, distribution and safety of application. This is accomplished by the nozzle design or type, its operating pressure, its orifice size, its fan angle and its distance from the target.

There are essentially four basic nozzle spray patterns. All other patterns are variations. These are:

1. **Solid stream.** A compact jet often used in hand-guns to spray a distant target or used in nozzles

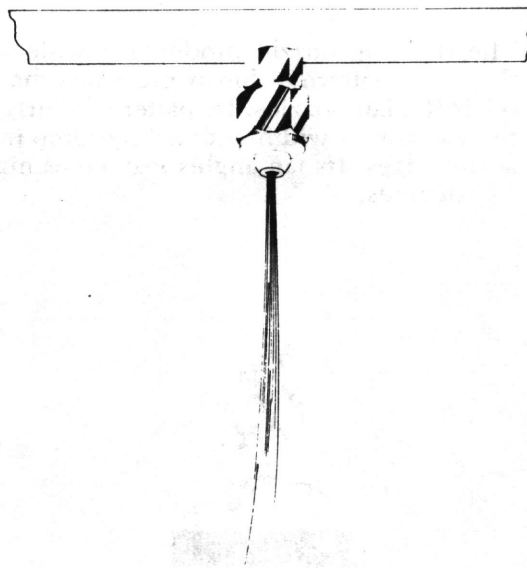

to apply a narrow band or barrier or to inject into the soil.

2. *Flat fan.* This pattern is produced by three nozzle types:

- The regular flat fan nozzle produces a narrow oval pattern having lighter edges for broadcast spraying. It has fan angles of 60-110 degrees and should be overlapped 30-50 percent for even distribution.

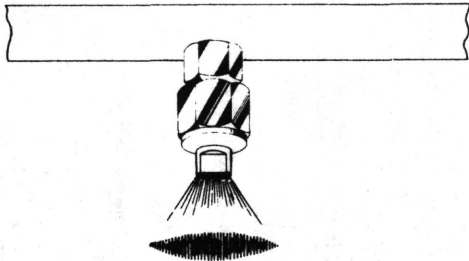

- The even flat fan nozzle produces a pattern with a fairly uniform rate across its width that drops rapidly on its edges. It has fan angles of 80-95 degrees and is intended for band spraying.

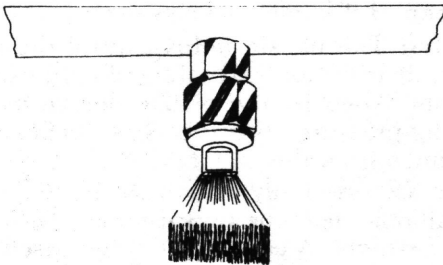

- The flooding nozzle produces a wide angle flat spray pattern at lower pressures than the other flat fan nozzles. Its pattern is fairly uniform across its width with a rapid drop in rate at the edges. Its fan angles may be as high as 145 degrees.

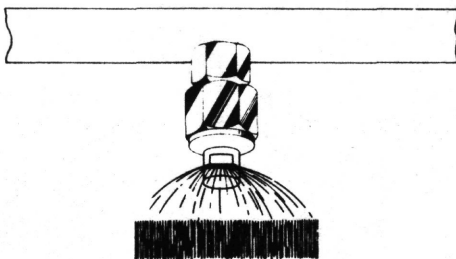

3. *Hollow cone.* This pattern is a circular one with tapered edges and little or no spray in the center. The core and disc type produces fan angles of 50 degrees to 110 degrees by the use of a core or whirl plate ahead of a disc with orifice. The whirl chamber provides angles up to 130 degrees using a tangential entry to a whirl chamber above a conical outlet.

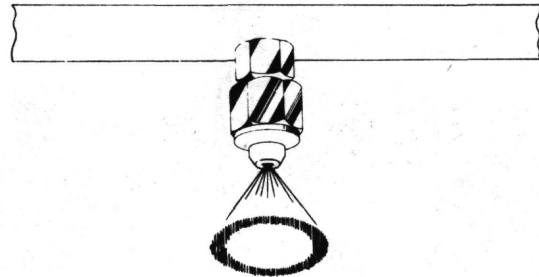

4. *Full cone.* This is a circular pattern with the spray well-distributed throughout the pattern. This is frequently accomplished by using a disc and core and both tangential slots plus an orifice in its center. Fan angles are up to 110 degrees.

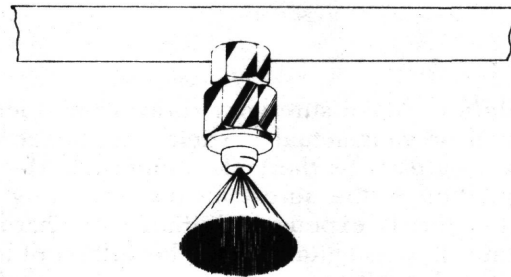

There are choices of more than one nozzle type or pattern for many spraying jobs. In general, the regular flat fan nozzle, flooding fan nozzle, and whirl chamber hollow cone nozzles are preferred for weed control. Where herbicide drift control is most essential the flooding nozzles and whirl chamber nozzles provide larger drops and adequate patterns at lower pressures. They also have the added benefit of less nozzle clogging. For chewing type insects these nozzles or the hollow cone nozzles can be used in field crops. For other insects and for disease control, hollow cone nozzles should be used.

Nozzles are available in various materials, but brass is the most common. Brass is inexpensive and machines well, but is subject to rapid wear from abrasion. Stainless steel is noncorrosive and much more resistant to abrasion than brass, especially if it is hardened. Nylon and other plastics are resistant to corrosion and have fair abrasion resistance, but are subject to swelling when exposed to some liquids. Aluminum is resistant to some corrosive materials but easily corroded by others, such

as some nitrogen fertilizers. Tungsten carbide is highly resistant to abrasion and corrosion but is available only in disc type hollow cone nozzles and is expensive. For limited use, brass tips are probably best. As more use is planned, especially of corrosive or abrasive pesticides, other materials should be considered.

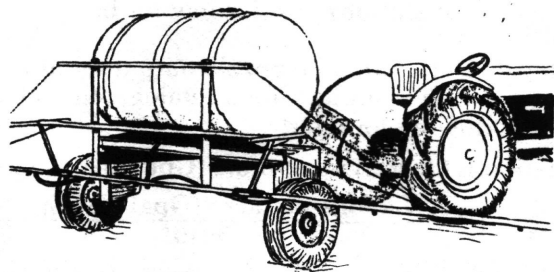

Use and Maintenance of Ground Sprayers

General: These comments are based on use of low-pressure field sprayers. Other sprayers would be similar in use and maintenance.

Before spraying, rinse out the entire system and remove and clean nozzles, nozzle screens, and strainers. Make sure strainers and nozzle screens are 50 mesh or larger if wettable powders will be used. Make sure nozzles are all the same type, size and fan angle. Nozzle caps should not be cracked or overtightened, especially if plastic. Check lines, valves, seals and tank after filling with water and during running to determine that there are no leaks.

Adjust nozzle height and spacing as suggested by the manufacturer and pesticide label and as required for crop or pest. Allow for crop or weed height if necessary. If spraying soil surface, a good check is to spray on asphalt pavement and watch for streaks as you increase speed or as spray dries. Check each nozzle for uniform flow using water and a jar marked in ounces. Replace any having flows 5 percent more or less than the average. While doing this, check patterns and replace any nozzles having heavy or light streaks.

Tanks: Flush out the tank, pump, lines and nozzles after each day's use and at the end of each separate pesticide use. If switching to another pesticide where contamination must be prevented, wash out with detergent and water two or three times and then flush with water. Phenoxy herbicides such as 2,4-D are hard to remove. After their use, either follow the special cleaning procedures noted on the pesticide label or avoid using the same sprayer for any other product. Keep tank clean inside and out. Tighten or repair all leaky tank seals or fittings. Make sure sight gages can be read.

Pumps: Do not operate dry or with a restricted inlet as pump damage will occur. Do not store with water in the pump, but fill or coat with light oil.

Mountings on tractor PTO shafts should be restrained from turning by chains or torque bars not bolted down. Do not operate at speeds or pressures higher than the manufacturer recommends. Keep all shields in place.

Hoses and fittings: Keep hoses from kinking or being abraded. Rinse off often to prolong life. Remove and store hoses during off season, or at least store unit out of sun. Replace at the first sign of deterioration, because weak hoses are unsafe.

Pressure gages: Check frequently for accuracy against an accurate gage and prevent overpressure. Keep glass faces clean and intact. If gages fail to last, use gage protectors to protect against corrosive pesticides and pressure surges.

Strainers: Clogged line strainers can cause undetected low pressures if boom pressure gages are not used, and clogged nozzle screens can always cause such an effect. Clean strainers frequently and replace them if deterioration begins. They are your best defense against nozzle and pump wear and nozzle clogging. Use nozzle screens as large as nozzle sizes permit, but screen opening should be less than nozzle opening.

Nozzles: Select the proper nozzle type and size for the pest control needed and pesticide used. Clean and unclog nozzles only with a toothbrush or toothpick, never with metal objects such as wires and knives. Remove for off-season storage and when not in use store in unused oil or diesel fuel.

If you need to emphasize drift control, consider the advantages of the flooding flat fan nozzles used at low pressures. Don't forget also that with any nozzle lower pressures and larger outputs result in few fine drops to drift. Spray adjuvants to increase viscosity and increase drop size to reduce drift should also be considered. Keeping the nozzles low by spraying back to an angle from vertical and by using wide fan angles also helps because the wind decreases rapidly with decreased height.

Operation: During spraying do not use speeds too high for ground conditions. Booms bouncing up and down or back and forth can cause application rates to vary by 50 percent. Uneven ground causing the boom's ends to be too near and too far from the ground can cause uneven patterns; also some boom widths may have to be narrowed, separate boom sections adjusted on the go, or outrigger devices used. Outrigger devices extend out from each side and help stabilize the boom.

If nozzles clog or other trouble occurs in the field and the spray material is toxic, shut off the sprayer and move forward into the unsprayed area before dismounting and working on the sprayer. Be alert for nozzle clogging, changes in nozzle patterns, and the location of sensitive crops, waterways, people, pets, etc. Do everything you can to keep the spray on the target.

Filling and draining: Pick an area for filling your sprayer and draining and rinsing that will not contaminate any water supply and where other humans and pets are not likely to be present. Before opening the container and adding any pesticides, completely read the label and follow its directions for protective gear, actions, equipment operation, and selection. Follow the label's advice for mixing and adding pesticide to the tank. Do not mix more pesticide than you plan to use. It is better to apply all of it than have an excess for disposal. It is desirable to remove all pesticides, especially wettable powders, from the sprayer immediately after spraying is completed.

Storage: Before storage at the end of a season and after rinsing as suggested previously in the general section, almost refill tank with clean water. Then add a gallon or two of new light oil to the tank. Pump tank contents out through nozzles and handgun if present, thus coating the system. Drain pump and plug its openings. Remove nozzles and nozzle screens and store in oil.

Calibration of Sprayers

General: Performance of any pesticide depends on the correct amount of chemical being applied properly. The purpose of calibration is to adjust the equipment to apply a specified amount of material uniformly over a given area. The volume of spray applied depends on the following three variables:

1. **Nozzle flow rate.** Nozzle flow rate varies with the orifice size of the nozzle, the nature of the fluid and the pressure on the fluid. Flow rate is generally proportional to the square root of the pressure at the orifice.
2. **Ground speed of the sprayer.** Increasing the ground speed decreases the spray volume in proportion. It is the easiest factor to change for minor corrections in application volume.
3. **Sprayed width per nozzle.** Increasing the sprayed width per nozzle (nozzle spacing) decreases the spray volume.

Equipment needed: You will need calibrated containers of proper size (1 pint or quart for low gallonages, 1 gallon for large gallonages per acre), a 100-foot tape, a watch with sweep second hand, stakes to mark distances and an accurate pressure gage on the sprayer.

Nozzle tip selection: Selecting the proper nozzle tip is the most important step in sprayer calibration.

Step 1. Determine the suggested sprayer application volume in gallons per acre (**Gpa**) from the pesticide label or printed recommendations. Application volume is the gallons of carrier (water, fertilizer, etc.) plus pesticide applied per treated acre.

Step 2. Select an appropriate ground speed in miles per hour (**Mph**) according to existing field condition.

Step 3. Determine the spray width per nozzle (**W**) in inches.

For boom spraying, **W** = nozzle spacing

For band spraying, **W** = band width

For row crop applications such as drop spraying or directed spraying,

$$W = \frac{\text{row spacing (or band width)}}{\text{no. of nozzles per row (or band)}}$$

Step 4. Determine the nozzle output required by using a nozzle manufacturer's catalog, other charts, or the following formula:

$$\text{Equation 1. Gallons per minute (Gpm) per nozzle} = \frac{\text{Gallons per acre (Gpa)} \times \text{Mph} \times \text{W}}{5940^*}$$

where **Gpa**, **Mph**, and **W** are from Steps 1-3

(5940 is a constant that will convert gallons per hour per acre to gallons per minute per square inch.)

Step 5. Select a nozzle that will give the output determined in Step 4 when operating within the recommended pressure range. At this point you may decide to use another operating speed in order to use nozzles you already have.

Precalibration check: If not done in last 50 hours of use, check all nozzles at operating pressure using water for uniform output, equal fan angle, and uniform appearance of spray pattern. Replace any nozzle having flow 5 percent more or less than average or having obviously different fan angles or patterns.

The use of water alone for calibration is highly desirable, but if the diluent is other than water, or the pesticide or additives change the mixture considerably, check to see if there is a difference in flow rates between the spray mixture and water. If this difference is more than 5 percent, use the actual mixture and avoid any contact with spray. Also try to avoid contaminating the area around the calibration area.

Calibration: Calibration manuals usually come with the sprayers. If a manual is not available, the equipment can be calibrated to deliver the amount of spray desired by:

1. Measure the distance traveled, in feet, in one minute at the speed you will use in applying the pesticide; use this value for **L** in the calculations below.
2. Measure the width, in feet, of the swath that will be covered by the pesticide (measure the width from end to end even though the pesticide will only be applied in narrow bands across this width); use this value for **W** in the calculations below.
3. Count the number of nozzles that will be used; use this value for **N** in the calculations below.

*Using 6000 instead of 5940 makes calculation easier and results in only 1 percent error.

4. Collect and measure the spray, in liquid ounces, delivered in one minute from several nozzles at the approximate settings that you will use, or use equation 1 to determine this. Determine the average amount delivered in one minute from these nozzles and use this value for A in the calculations below.
5. Determine the gallons per acre delivered by a sprayer using the following equation:

$$\text{Equation 2. Gallons per acre} = \frac{340 NA}{WL}$$

(340 is a constant that will convert ounces per square foot to gallons per acre.)

Example:

Tractor speed (L) is 176 feet per minute
 Eight 36 inch rows covered (W = 24 feet)
 Eight nozzles used (N = 8)
 Twenty liquid ounces of spray per nozzle per minute (A = 20)

$$\text{Gallons per acre} = \frac{340 \times 8 \times 20}{24 \times 176} = 12.88$$

Dusters

Hand dusters: Like hand sprayers, hand dusters are used primarily for small areas such as homes and gardens. They may consist of just a squeeze tube or shaker, a sliding tube or a fan powered by a hand crank. They have the advantage that the pesticide is already diluted and ready to apply so they are fast and easy to use on small areas or for spot treatment. Their limitations are: (1) pesticide is more expensive; (2) it is difficult to get good coverage; and (3) dust is much more subject to drifting.

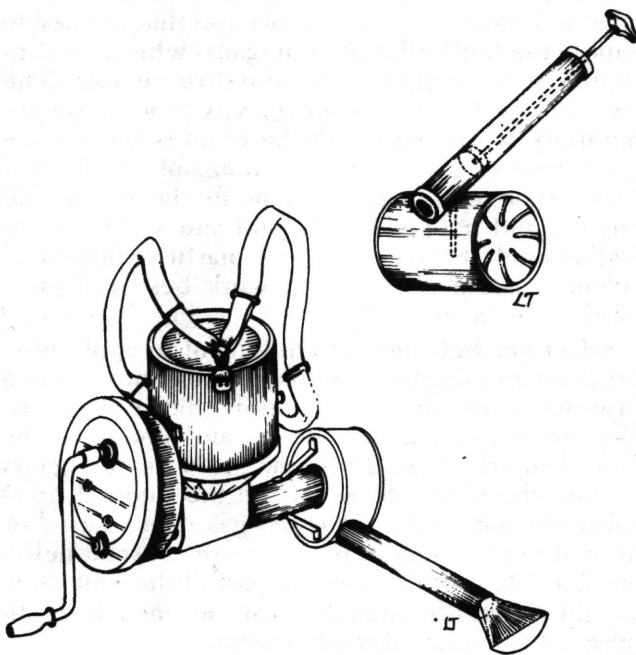

Power dusters: Ground-rig power dusters utilize a powered fan or blower to propel the dust to the target. They range from knapsack or backpack types to tractor-mounted or pulled. Their capacity in acres per hour compares favorably with most sprayers, they are simply constructed, easy to maintain, and low in application cost exclusive of pesticide cost. However, the increased hazards from drift and restrictions on time of use have caused their use to decrease.



Selection: Before selecting a duster you should decide if you will be able to use it with enough pesticides to justify its purchase. You are more likely to be able to justify hand dusters than power dusters due to their convenience and the availability of low toxicity pesticides in dust form for small area use.

In selecting power dusters, look for models that are easy to clean and that give uniform distribution across the swath and uniform application rate as the tank is emptied. For both hand and power dusters also look for those that keep the dust cloud well away from the operator.

Granular Applicators

These range from crank-operated, spinning-disc, knapsack types for broadcast coverage to those applying bands over the row in row crops to powered applicators covering 20-foot widths or more ahead of incorporating tools. Granules, like dusts, already are diluted so there is no need for mixing.

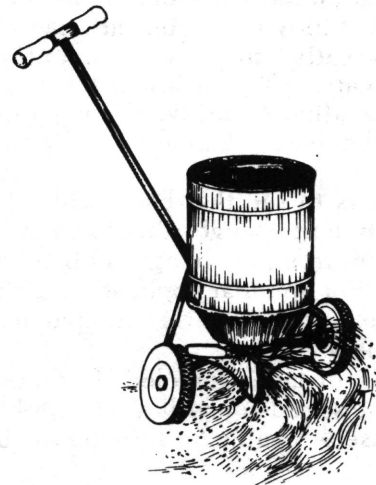

Advantages are the elimination of mixing, the relatively simple, low-cost, trouble-free equipment, and the control of drift. Limitations are: (1) higher cost for pesticide, (2) use on some pests is limited because granules won't stick to targets such as plants, (3) must calibrate for each granular formulation and applicator, and (4) lateral distribution can be poor, especially on side slopes.

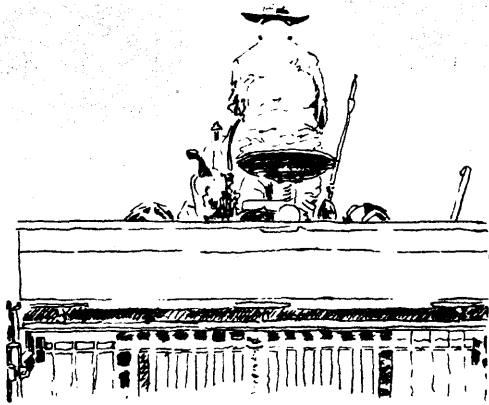

Selection: In selecting granular applicators, whether they will be used for broadcasting or banding, choose ones that are easy to clean and fill.

Check to see that they have good *agitation* over the outlet holes to prevent bridging and keep flow rate constant. If you are looking at a band applicator, the run from hopper to bander should not be long and shallow. Banders should spread band evenly even upon side slopes of 10 to 15 percent. Chain drives should use sprockets of eight teeth or more to keep drive speed uniform. Design should be such that application stops when drive stops even if outlets aren't closed. The drive should be strong enough to turn and not break after road travel with tank filled with granules.

Use and maintenance: Both dusters and granular applicators are speed sensitive so try to maintain uniform speed. Do not travel too fast for conditions, as bouncing applicators will have a widely varying application rate. Stay out of any drift cloud that may form. Windy conditions are bad for dusters and can greatly affect the distribution from granular applicators. Try to finish the day or job with each box almost empty. Clean equipment well at the end of each job as advised by operator's manual.

Watch banders to see that band width is maintained. Small height changes due to changing soil conditions result in rapid changes in band width.

Calibration: For granular application calibration, the procedure below, similar to that used for sprayers, can be used:

1. Measure the distance traveled, in feet, in one minute at the speed you will use in applying the pesticide; use this value for L in the calculations below.

2. Measure the width, in feet, of the swath that will be covered by the pesticide (measure the width from end to end even though the pesticide will only be applied in narrow bands across this width); use this value for W in the calculations below.
3. Count the number of nozzles that will be used; use this value for N in the calculations below.
4. Collect and weigh the granules, in ounces, delivered in one minute from several nozzles at the approximate settings that you will use. Determine the average amount delivered in one minute from these nozzles and use this value for A in the calculations below.
5. Determine the pounds per acre delivered by a granular applicator using the equation:

$$\text{Equation 3. Pounds per acre} = \frac{2723 \text{ NA}}{\text{WL}}$$

(2723 is a constant that will convert ounces per square foot to pounds per acre.)

Example: Tractor speed (L) is 176 feet per minute
 Eight 36 inch rows covered (W = 24 feet)
 Eight nozzles used (N = 8)
 Two ounces of granules per nozzle per minute (A = 2)

$$\text{Pounds per acre} = \frac{2723 \times 8 \times 2}{24 \times 176} = 10.31$$

Fumigators and Injectors

Equipment is of two types — that needed to handle low-volatility fumigants and that needed to handle the high-volatility fumigants which are kept liquid only by storage in pressure vessels. The low-volatile fumigators are gravity-flow or pumped units, while the high-volatile units usually use a compressed gas to force the fumigant into the soil or space being fumigated. Some fumigants are safe enough and trapped by the soil and soil moisture well enough that covering with plastic or other seal is not necessary. But most work best and most safely if seals are used.

Selection: Selection of equipment to apply non-pressure fumigants is similar to selecting a good low-pressure sprayer except that corrosion-resistant pumps, tanks, fittings and lines may be more important. In addition, pressure fumigants require the ability to withstand the internal pressures created by the liquefied gas when stored or used at high temperatures to assure constant delivery rates. If soil injectors are part of the unit, they should be sturdy enough to run at enough depth for good retention of the fumigant.

Use and maintenance: All the units, but especially the pressurized ones, should be kept in good repair. Make sure there are no leaks and that hoses and fittings are replaced as soon as signs of deterioration occur. Lines and fittings should not be located near the operator. All lines should be emptied except when actually applying fumigants. All precautions suggested by the fumigant label should be carefully observed. To avoid cross-contamination and corrosion, properly flush the units after use following directions on the label.

Calibration:

1. *Calibration of nonpressure fumigators* is done as described under calibration of field sprayers.
2. *Calibration of pressure fumigators.* Since the fumigant vaporizes when released from pressure and is usually toxic, catching it in a calibrated container is not practical. Instead, one can usually come close to the right rate by the use of manuals and label information to select an operating pressure and outlet orifice size to give a certain flow rate. This, along with outlet spacing and travel speed, can be varied to give the desired application rate.

By starting with a known amount of fumigant and checking the amount used on a known area, one can check with application rate using Equation 2. The results should be close enough that changes in speed and operating pressure can be made to get the correct rate.

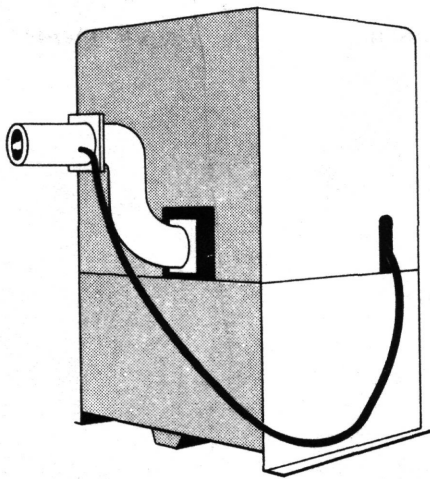

Aerosol Generators and Foggers

Aerosols are droplets that are so small that they literally float in the air. Many of the droplets are so small that they penetrate into hard-to-reach areas

such as heavy vegetation and recesses in buildings, exposing the entire volume to pesticide. However, this characteristic makes them extremely likely to drift. Hence only a few pesticides and formulations are suitable for use. Aerosols are generated by air atomizers or pneumatic nozzles, spinning discs, small nozzles at high pressure, and aerosol spray cans. Fogs are usually generated by thermal generators using heated surfaces. Fog particles are so small that they settle out even less than aerosols. Both aerosols and fogs are widely used as space sprays giving good but temporary control since residual action is minimal.

Selection: Your selection of a machine for producing aerosols is governed by the droplet size you wish to produce: Keep in mind that the finer the aerosol drops produced the more restricted you will be by the weather conditions when using the unit in open air. For inside use you may wish to produce an extremely fine fog, so your basic choice may be primarily on type of use, inside or out. For coarse aerosols you can choose among: (1) hydraulic spray nozzles at 250 psi and above, (2) spinning discs or screens with peripheral speeds above 15000 fpm, or (3) air-shear using hydraulic nozzles in an airstream having relative velocities between the two fluids of 250 or 300 PMH.

For fine aerosols and fogs the following systems are available: (1) Bifluid nozzles either air-liquid or biliquid resulting in very high relative fluid velocities, (2) liquid flashing where a highly evaporative carrier is stored under pressure and the liquid pesticides are released at high velocity through a small orifice forming a fine spray which further reduces to aerosol drops as the carrier flashes or evaporates, and (3) thermal foggers which flash the liquid pesticide by contact with a hot surface or by mixing with steam.

Only the coarse aerosols should be considered for aerial use. Of the fine aerosol generators, the thermal fogger produces the finest drops and also tends to produce a dense fog which obscures the operator's view and tends to be dangerous if it gets carried across vehicular traffic.

Use and maintenance: The suggestions made under sprayers apply here. In addition, some words of caution are advisable. These machines produce a spray cloud that is extremely mobile. You must make sure that the pesticides used in them are cleared for such use and then when used are kept on the target. This means you must be sure of the weather conditions not only when spraying but for a period afterward. Regardless of inside or outside use, the operator, other people, pets, etc., must be kept out of the spray cloud or be properly protected.

Self-Help Questions on Section 4 – Spray Equipment

Now that you have studied Section 4, answer the following questions. Write the answers in pencil without referring back to the text. When you are satisfied with your written answers, see if they are correct by checking them with the text. * If your first answer is wrong, erase it and write in the correct answer. Note that these questions are not necessarily those that are used in the certification examination.

1. What are crack and crevice treatments used for? **Type** **Advantages** **Disadvantages**

High pressure

2. How do furrow applications differ from soil band applications?

Air blast

3. Can ULV materials be applied aerially?

Mist blowers

4. What are the two things you must know to calculate the amount of formulation to be used?

7. List the requirements of the following sprayer components:

5. How can you calculate the amount of pesticide to be used in some volume of water other than the volume of water specified on the label?

Component **Requirements**

Tanks

Pumps

Strainers

Hoses

Pressure gages

Pressure regulators

Agitators

Control valves

6. List the advantages and disadvantages of the following types of sprayers:

Type
Small capacity

Advantages

Disadvantages

Low pressure field

*The questions are arranged in the order that they appear in the text.

8. *List the basic types of spray patterns and give a description of each.*
9. *Spray nozzles are made from a number of materials. List five and give the advantages and disadvantages of each.*
10. *Describe the proper steps in daily maintenance of the sprayer tank.*
11. *List the three variables that must be taken into consideration when calibrating sprayers.*
12. *What is the single most important step in sprayer calibration?*
13. *Describe the procedure for calibrating a sprayer.*
14. *List 3 limitations of hand dusters.*
15. *What should you look for in selecting a power duster?*
16. *What are the advantages of granular applicators?*
17. *Describe the procedure for calibrating a granular applicator.*
18. *Explain the differences in the two types of fumigation equipment.*
19. *What factors must be considered in selection of an aerosol generator or fogger?*

SECTION 5: Pesticide Safety

PESTICIDE TOXICITY AND HAZARDS TO MAN



When a chemical has ingredients that can cause injury, we say that it is *toxic*, or poisonous. Manufacturers find out how toxic a pesticide is by testing it on laboratory animals. Results of these tests help determine the *hazards* of using the product — that is, the chances that injury will occur under certain circumstances.

Any pesticide can cause severe illness, or even death, if misused badly enough. On the other hand, every registered pesticide can be used safely if enough care is taken. You have a responsibility to help prevent *all* accidents with pesticides:

- by using and storing all pesticide materials so that children and other untrained persons cannot get to them, and
- by taking special care when working with a pesticide whose label says it could make you ill if you were overexposed to it. Most products for restricted use need this special care. In some cases, though, a product is restricted because of danger to the environment rather than danger to workers. The label is your best guide to proper use and proper precautions.

HOW MOST PESTICIDE POISONINGS HAPPEN



Children under 10 years old are the victims of at least half of the accidental deaths caused by pesticides in this country. If pesticides were always cared for properly none of these children would ever come in contact with them.

Nearly all accidental pesticide deaths, in both children and adults, are caused by eating or drinking the product. Some pesticide applicators, though, are killed when they breathe a pesticide or get it on their skin.

Most pesticides can be absorbed into the body through the skin. This happens slowly, but because so much pesticide is likely to get on the skin, you may get more into your body this way than by eating or breathing it.

We know that skin contact alone can cause death. It is possible to kill laboratory animals by applying a pesticide to their skins in such a way that they cannot eat or breathe it. People are known to have been poisoned by many different pesticides after contacting them only with their skin.

The organophosphates cause more cases of occupational poisoning and also more deaths than any other single group of pesticides. However, deaths from occupational exposure now are unusual. The next most important cause of deaths is arsenic, which formerly was the leading cause of fatal accidental poisoning associated with pesticides. Arsenic poisoning among applicators is rare.

SYMPTOMS OF PESTICIDE POISONING

You should know something about the kinds of sickness caused by the poisons you use and about the conditions under which each pesticide is likely to make a person sick.

Each pesticide or each group of pesticides that act the same way produces the same kind of sickness. This sickness may be so mild you can hardly detect it, or it may be increasingly severe depending on the dose absorbed. However, regardless of the severity, the pattern of illness produced by one pesticide or group of pesticides is similar. On the other hand, one or more symptoms may be common to many kinds of sickness, whether they are caused by poisons, germs, or whatever. Headaches and a feeling of being unwell, for example, may be the start of many kinds of illness. It is not one or two single symptoms but the pattern of symptoms that makes it possible to tell one kind of sickness from another.

Some clues to pesticide poisoning are feelings that only the person who has been poisoned can notice — such as nausea or headache. Others, like an ashen skin color, can be noted by someone else. So you should know not only what your own feelings might mean, but also what signs of poisoning to look for in your co-workers.



Get medical advice quickly if you or any of your fellow workers have unusual or unexplained symptoms beginning while at work or (in a few instances) later the same day. Do not let yourself or anyone else get dangerously sick before calling your doctor or going to a hospital. It is better to be too cautious than too late. If you think you may be poisoned, take the container (or the label) of the pesticide to the doctor.

Organophosphates

Symptoms of poisoning by organophosphates progress through several stages, for the most part reflecting interference with the enzyme cholinesterase in the central nervous system. The usual sequence of symptoms is as follows.

Mild poisoning:

- fatigue
- headache
- dizziness
- numbness in arms or legs
- nausea and vomiting
- excessive sweating and salivation
- abdominal cramps or diarrhea

Moderate poisoning:

- unable to walk
- generalized weakness
- muscular twitches
- contraction of pupil of the eye
- symptoms listed under "mild poisoning" become more severe.

Severe poisoning:

- unconsciousness
- contraction of pupil of eye severe
- muscular twitches
- respiratory difficulty
- death if not treated.

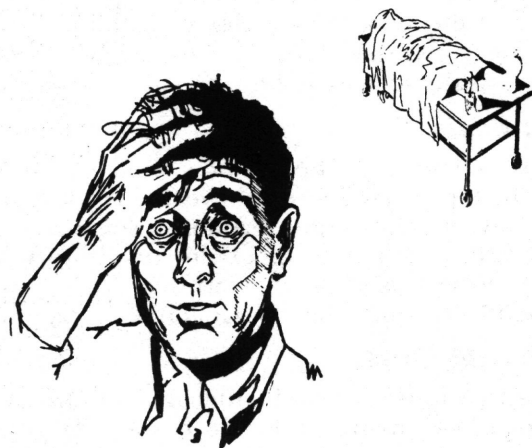

Illness frequently is delayed several hours so that you may first become sick at home after supper. But, if symptoms begin more than 12 hours after the last known exposure to the pesticide, illness is probably due to some other cause.

Carbamates

The only carbamates likely to cause illness through occupational exposure act in almost exactly the same way as the organophosphates. They produce the same symptoms if you are poisoned by them. The illness caused by carbamates is not as severe, however, so they are safer than the highly toxic organophosphates.

Organochlorines

Only a few organochlorines have produced occupational poisoning, but several of them are regularly stored in considerably higher concentrations in persons who use them than in the general population.

Early symptoms of poisoning include headache, nausea, vomiting, general discomfort, and dizziness. With more severe poisoning, convulsions follow, or they may appear without the warning symptoms just mentioned. Coma may follow the convulsions. Hyperexcitability and hyperirritability are common findings.

Nitrophenols and Pentachlorophenol

The symptoms of poisoning by one or a few relatively large doses of DNOC include headache, nausea, gastric distress, restlessness, a sensation of heat, flushed skin, sweating, deep and rapid respiration, fast beating of the heart, fever, ashen color, collapse and coma. Acute poisoning with DNOC usually runs a rapid course; death or almost complete recovery within 24 to 48 hours is the general rule.

Metals and Metalloids

The only metallic pesticides that cause many poisonings in this country are those containing arsenic. Large single doses of most heavy metal pesticides cause vomiting and stomach pain. The exact nature of the symptoms varies with the metal, but in all instances the illness is chronic and similar in many ways to diseases of totally different causes.

Botanicals

Most botanical pesticides now used are not very toxic in the usual sense. However, crude pyrethrum may cause allergic reactions. Some rotenone dusts are very irritating to the respiratory tract which serves as its own warning. Nicotine is a fast-acting poison about as dangerous as parathion.

Anticoagulants

The injurious effects of anticoagulants are due to loss of blood, mainly into the tissues. The initial symptoms in chronic warfarin poisoning are back pain and abdominal pain.

Fumigants and Solvents

Symptoms of excessive exposure to the less toxic compounds are those of drunkenness: poor coordination, confusion, and sleep. Rapid removal to fresh air is important. Methyl bromide is extremely

dangerous, because a toxic or even fatal dose can be absorbed before symptoms appear.

Bipyridyliums

These herbicides (paraquat, for example) may be fatal if swallowed and harmful if inhaled or absorbed through the skin. Lung fibrosis may develop if paraquat is taken by mouth or inhaled. Symptoms of injury may be delayed. Prolonged skin contact will cause severe irritation.

FIRST AID PROCEDURES FOR USE BY PESTICIDE APPLICATORS

Removal of Poison

The most generally useful first aid measure in most work situations is removal of the poison. This is especially true when there has been a splash or spill onto the skin. Prompt washing may prevent sickness even when the exposure is very dangerous.

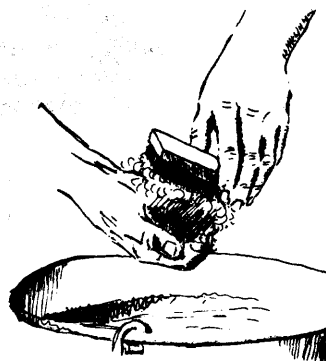

Water-wettable powders or suspensions are easy to remove with plain water. The same is largely true of emulsion concentrates and emulsions. Technical products or solutions of them in petroleum oil or other solvents are more difficult to remove without soap or a detergent. Detergents are more effective. Detergent bars rather than plain soap ought to be provided in washrooms and as part of emergency field washing facilities.

Remove all contaminated clothing. Wash the hair if it is contaminated. Move quickly.

If exposure has been by the respiratory tract, the sick person must go or be taken to fresh air as quickly as possible.

If pesticides are splashed into the mouth, rinse it out with plenty of water and go to the doctor immediately. If a pesticide is swallowed, it can be dangerous to induce vomiting; *check the label*. If label directions indicate vomiting, give one tablespoon ($\frac{1}{2}$ ounce) of syrup of ipecac. Do not wait for vomiting, but go *immediately* to a doctor. If you do not have syrup of ipecac, use one tablespoon of salt in a half glass of water. Do not wait for vomiting and *do not give any more salt water*. Go *immediately* to a doctor.



Artificial Respiration

The most critical first aid measure is artificial respiration. It is not needed often in poisoning, but if a poisoned or drowned person stops breathing, he must receive help at once.

PROTECTIVE CLOTHING AND OTHER SAFETY DEVICES

Pesticides can enter the body through many routes. To stop them, the applicator must wear a protective barrier. No safety recommendations can cover all situations. Your common sense should tell you to use better protective clothing and devices as the hazard increases. *Always read the pesticide label for recommendations on the use of protective clothing or devices.*

Gloves

When you handle concentrated or highly toxic pesticides, wear liquid-proof gloves (such as rubber or neoprene). They should be long enough to protect the wrist not normally covered by the sleeves. Gloves should not be lined with a fabric, since this is hard to clean if it gets a chemical on it. Never use cotton or leather gloves. They absorb



pesticides and do not give good enough protection. Sleeves usually should be *outside* of the gloves to keep pesticides from running down the sleeves and into the gloves.

Body and Waterproof Covering

You should wear at least a long-sleeved shirt and long-legged trousers or a coverall type garment (all of closely woven fabric) any time you handle pesticides. When handling pesticide concentrates or very toxic materials, you should also wear a light-weight raincoat or rubber apron. Trousers should be worn *outside* of the boots to prevent pesticides from getting inside.



Hat

Always wear something to protect your head. Where there is downward drift, wear a wide-brimmed waterproof hat to protect your neck, eyes, mouth and face. These should not have a cloth or leather sweatband since these are hard to clean if they get chemicals on them.



Boots

Wear lightweight, rubber boots when you handle or spray pesticides. Both leather and canvas boots absorb chemicals and are hard to clean.



Wash goggles or face shields at least once a day. Fabric headbands often absorb pesticides, and are difficult to clean. Have several spares so you can replace them often.

Goggles or Face Shield

Wear goggles or a face shield when there is any chance of getting pesticides in your eyes. The eyes will absorb many pesticides which may affect vision. Goggles can be worn separately or with a respirator.

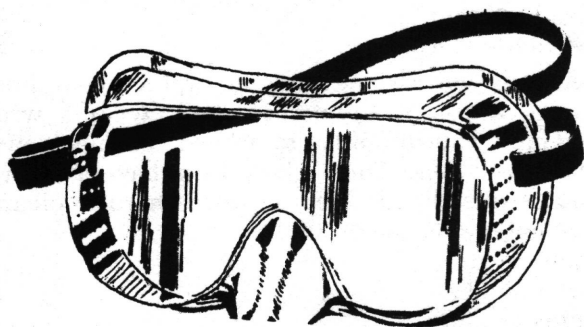

Respiratory Protective Devices

The respiratory tract — the lungs and other parts of the breathing system — is much more absorbent than the skin. You *must* wear an approved respiratory device any time you might inhale toxic pesticides. Follow carefully the label instructions on respiratory protection. You probably will need a respirator:

- if you will be exposed to a pesticide for a long period,
- if the pesticide you are using is highly toxic, or
- if you are working in an enclosed area.

Chemical cartridge respirator: Inhaled air comes through both a filter pad and a cartridge of activated charcoal. Most harmful vapors, gases and particles are removed. These half-face masks cover the mouth and nose. To cover the eyes also, use a combination cartridge respirator and goggles.



Care of Clothing and Devices

A clean set of clothing should be worn daily. If fabrics get wet with a dilute spray during the day, they should be changed. If clothes get wet with liquid concentrates of highly toxic pesticides, throw them away. They are hard to get clean enough by normal methods. Do not store or wash contaminated clothing with the family laundry. Wash gloves and boots daily, and test gloves for leaks by filling them with water and gently squeezing.

Chemical canister respirator or gas mask: Gas mask canisters contain more and longer-lasting absorbing material and filters than cartridge respirators. You should wear one when you mix or apply toxic pesticides in close or poorly ventilated spaces. Gas masks usually protect the face better than cartridge types, and may leak less because they fit tighter. A chemical respirator will not protect you when the oxygen supply is low, as in a silo.



Supplied air respirator: You should wear this type of respirator when the oxygen supply is low, or when you are exposed to high concentrations of very toxic pesticides in enclosed areas. Fresh air is pumped through a hose to the face mask.

Self-contained breathing apparatus: This respirator does about the same thing as the supplied air respirator. The difference is that you carry the oxygen supply with you, usually in a cylinder on your back. This lets you move more freely than you can with a supplied air respirator.

Care and maintenance. Specific types of cartridges and canisters protect against specific chemical gases and vapors. Be sure you choose a type made to protect against pesticides.

The respirator must fit the face well to insure a good seal. Long sideburns, a beard, or glasses may prevent a good seal.

During heavy spraying, the filters in chemical cartridge respirators should be changed twice a day, or more often if breathing becomes difficult. Cartridges should be changed after eight hours' use, or sooner if you smell pesticides. Remove filters and cartridges after use. Wash the face piece with soap and water, rinse it, dry it with a clean cloth, and store it in a clean, dry place away from pesticides.

The useful life of a cartridge or canister depends on:

- the type and amount of chemical fill,
- the concentration of contaminants in the air,
- the breathing rate of the wearer, and
- the temperature and humidity.

Read carefully the manufacturer's instructions on the use and care of any respirator and its parts before you use it. Only respirators approved by the National Institute for Occupational Safety and Health (NIOSH), or the U.S. Bureau of Mines should be used. The U.S. Department of Agriculture no longer approves respirators, but old lists can still be used for guidance.

Wearing a respirator does not replace the need for protective clothing on other parts of the body.

SAFE USE PRECAUTIONS

Exposure to pesticides occurs under many different conditions, including: moving pesticides from one location to another, storage, mixing, checking application equipment before use, loading, applying, working in pesticide-treated crops, cleaning application equipment after use, disposal of unwanted pesticides and empty containers, cleanup of pesticide spills, and cleaning of personal protective clothing and other protective equipment.

Some of these operations take place indoors; many occur outdoors. Each operation requires some safety practices to prevent contamination of people, animals and plants as well as soil and water not intended to be treated.

You can prevent exposure to a pesticide if you use common sense and follow safety precautions. Here are the minimum safety procedures needed for each step of a typical operation, from the time of pesticide selection until completion of all cleaning.

Before You Buy a Pesticide

The first and most important step in choosing a pesticide is to know — without any doubt — the specific pest you need to control. Then find out which pesticides will control that pest. You may have a choice of several. You can get many publications to guide you. Common sources of information are the U.S. Department of Agriculture, most agricultural schools, and pesticide manufacturers and dealers.

At the Time of Purchase

Read the label of the pesticide you intend to buy to find out:

- if this is the best chemical for your job,
- if the product can be used safely under your conditions,
- if the formulation and amount of active ingredient are right for your job, and
- if you have the right equipment to apply the pesticide.



Before You Apply the Pesticide

Read the label again to determine:

- the protective equipment needed to handle the pesticide,
- the specific warnings and first aid measures,
- what it can be mixed with,
- how to mix it,
- how much to use,



- safety measures for the applicator,
- when to apply (check harvest waiting periods),
- how to apply,
- the rate of application,
- restrictions on use, and
- special instructions.

Transportation of Pesticides

You are legally responsible for the safe transport of your pesticide.

1. The safest way to carry pesticides is in the back of a truck. Fasten down all containers to prevent *spillage*. If you use a flatbed truck, you need side and tail racks on it.

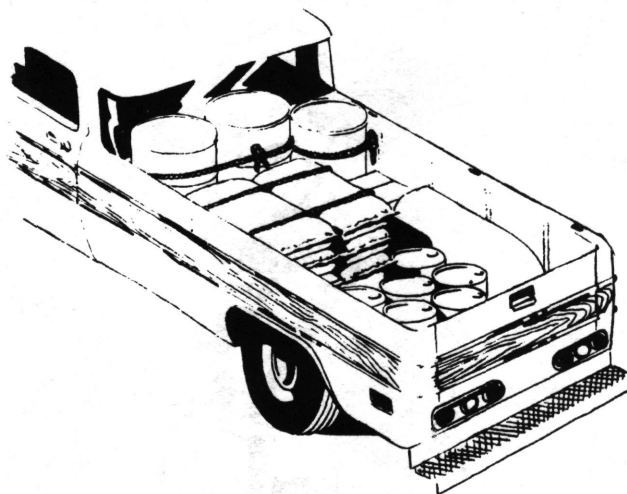

2. Never haul pesticides in the same compartment with food or feed or in the passenger compartment of any vehicle.
3. Pesticides should be packaged in the manufacturer's original container. Protect containers made of paper, cardboard, or similar materials from moisture.
4. Check with the chemical supplier to find out if you must have signs on the sides of your vehicle (placards) to indicate that you are hauling pesticides. These signs can be obtained from the manufacturer.
5. If any pesticide is spilled in or from the vehicle, immediately clean up the spillage.
6. Do not leave pesticides unattended when you get them to your property. You are responsible if accidents occur because pesticides have been left unattended.

Pesticide Storage

Read the label directions for correct storage procedure.

As soon as pesticides are delivered to your property, correctly store them in a locked and posted facility where children and other untrained persons cannot get to them.

The storage place should keep the pesticides dry, cool and out of direct sunlight. It should have enough insulation to keep the chemicals from freezing or overheating.

It is a good idea for the storage to have fire-resistant construction, including a cement floor, an exhaust fan, good lighting and a lock on the door. Keep the door locked whenever the facility is not in use.

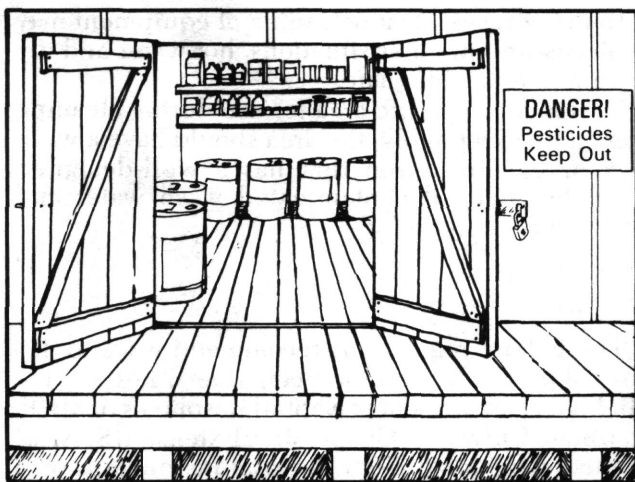

Locate storage facilities away from human and livestock habitations to avoid or minimize contamination in case of fire.

Do not store fertilizers and pesticides in the same building; pesticide fires must be handled differently than fertilizer fires.

Store all pesticides in the original containers. Never put pesticides in any other container.

Do not store pesticides near food, feed or seed.

Never store hormone-type herbicides with other pesticides. This kind of herbicide can contaminate other pesticides, causing severe damage to crops.

Periodically check every pesticide container for leaks or breaks. If you find a damaged container, immediately transfer the contents to a container with an *identical label* – a container that has held exactly the same formulation and concentration of the same chemical. Clean up any spilled material.

Mixing and Loading Pesticides

Before handling a pesticide container, put on the correct protective clothing and other necessary protective equipment.



Each time you use a pesticide, carefully read the directions for mixing before you remove the material from the container. This precaution is essential since directions, including amounts and methods, are changed from time to time.

Mix pesticides out-of-doors in a place where there is good light and ventilation. If you must mix or load pesticides indoors or at night, work where there is good lighting and air circulation.

When mixing pesticides, measure accurately. Use only the amount specified on the label.

When removing a pesticide from the container, keep the container below eye level to avoid a splash or spill on your goggles or protective clothing. Follow the same practice when pouring or dumping any concentrated pesticide.

If you splash or spill a pesticide while mixing or loading, stop immediately, remove contaminated clothing, and wash thoroughly with soap and water. *Speed is essential.*



Use a sharp knife to open paper containers; do not tear them open.

When loading pesticides, stand upwind to avoid contaminating yourself.

To prevent spills, be sure to replace all pour caps and close bags and other containers after use.

Do not work alone, especially at night.

Keep all mixing, loading and application equipment in a place where unauthorized persons cannot come in contact with it.

If mixing, loading or application equipment must be repaired before it is completely decontaminated, warn any persons of the possible hazards of exposure to chemical residues before the repairs are begun.

Pesticide Application

Thoroughly check all application equipment for leaking hoses or connections, plugged or worn nozzles, and good seals for filler openings to prevent spillage of chemicals.

Use water to correctly *calibrate* the equipment before use.

Never apply a pesticide if winds can cause substantial drift of the chemical out of the target area. If winds come up during the operation, immediately stop the application. Do not resume the application until conditions improve.

Before beginning an application, clear all livestock and humans from the area to be treated.

Cleaning of Mixing, Loading and Application Equipment

Immediately after use, have trained personnel thoroughly clean — inside and outside — mixing, loading and application equipment. Persons who clean contaminated equipment should wear correct protective clothing, including rubber boots, goggles, apron and gloves.

Use the correct rinse procedure:

1. Empty the container into the tank; let the container drain an extra 30 seconds.
2. Add the correct amount of water for thorough rinsing.
3. Replace the closure and rotate, upending the container so the rinse reaches all the interior surfaces.
4. Drain the rinse solution from the container into the mix tank. Allow the container to drain for 30 seconds after emptying.
5. Repeat this same procedure at least two more times for a total of three rinses. Remember: It is important to empty each rinse solution into the mix tank so the pesticide goes on the crop or area for which it is intended.

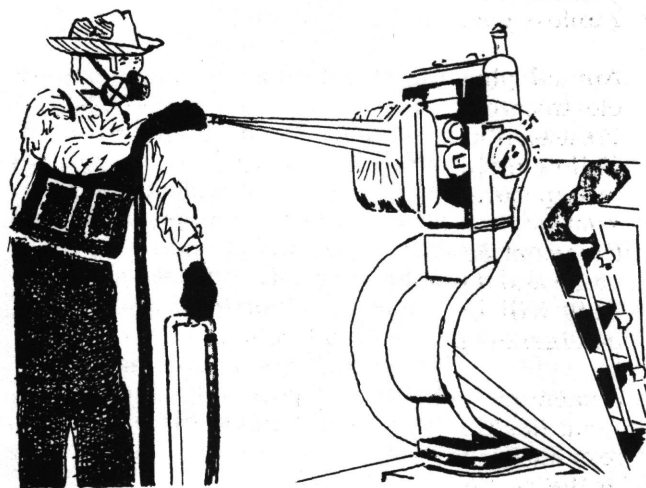

In many cases, steam cleaning of equipment may be necessary; in other situations, hot water and detergent may be adequate.

Designate a specific area for use during cleaning operations. Preferably, the area should have a wash rack or cement apron that has a well-designed sump to catch all contaminated wash water and pesticides.

Disposal

The federal regulations recommend ways to dispose of pesticides and their containers. Refer to the Michigan Department of Natural Resources or Michigan State University Cooperative Extension Service, or the pesticide label for disposal instructions on a specific pesticide. Residues and rinse liquids should be disposed of in the manner prescribed for each pesticide.

Cleanup and Decontamination of Pesticide Spills

Minor spills: Do not permit any unauthorized person to get into or near any spilled chemical. Rope off the area or flag it to warn all persons of possible danger. Do not leave the area unless someone is there to take the necessary measures.



If anyone was contaminated when the spill occurred, give first aid appropriate to the chemical involved.

Confine spilled chemicals. If the chemical starts to spread, contain it by diking it up with sand or dirt.

Use an absorbent material, such as fine sawdust or other specially designed material, to absorb (soak up) the pesticide. Shovel all contaminated material into a leakproof barrel for disposal. Do not hose down the area; this spreads the chemical.

Decontaminate the area. You may be able to use common household bleach, a solution of lye, ammonia, or even strong detergent and water to clean up an area. If you are not sure what material to use for clean up, call the chemical manufacturer for instructions.

Do not permit anyone to enter the area until it is thoroughly decontaminated.

Major spills: If the clean-up (decontamination) job appears too big for you to handle or if there is any doubt in your mind about the correct procedure, follow the first three steps under minor spills. Then call the pesticide manufacturer for assistance.

If a major pesticide spill occurs on a highway, have someone call the highway patrol or the local sheriff for assistance. (You should always carry these telephone numbers with you.) Do not leave the area until responsible assistance arrives.

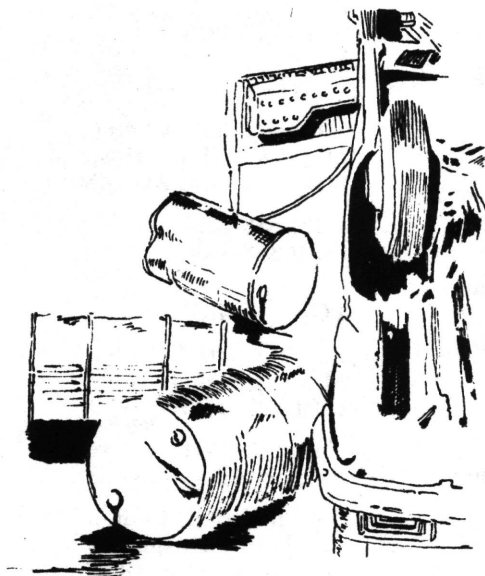

The National Agricultural Chemicals Association has a Pesticide Safety Team Network. This network can tell you the correct decontamination procedures to use or can send a local safety team to clean up the spill. You can call them collect any time at (513) 961-4300.

Report all major spills by telephone to Pesticide Safety Team Network (513) 961-4300. You also may need to notify other authorities:

- If a state highway is the site of a spill, notify the highway patrol and the state highway department.
- If a county roadway or a city street is the site of a spill, notify the county sheriff or city police.

- If food is contaminated, notify state or federal food and drug authorities and city, county, or state health officials.
- If water is contaminated, notify public health authorities; regional, state, or federal water quality or water pollution authorities; and the state fish and game agency.

Safe-entry times: It is dangerous for workers to enter an area after pesticides have been used. The time that must pass before the area is safe again is called a safe-entry time, or re-entry period. This time is given on each pesticide label and varies according to the pesticide applied and the site treated. These safe-entry times have been set to allow pesticide residues to break down to low levels or to disappear completely.



Personal Health

In addition to the already mentioned precautions, all persons working with pesticides should be involved in a regular health surveillance program. This should be established with your family or company physician and should minimally include the following unless your physician determines otherwise.

- Annual physical examination with chest x-ray, electrocardiogram, and electroencephalogram.
- Preseason blood cholinesterase test.
- Follow-up blood cholinesterase tests as indicated by exposure to organophosphate pesticides.
- Your physician and local poison control or poison treatment center should be furnished with your name and a list of the specific materials you use. This will be of considerable assistance in an emergency, particularly if you are unconscious.

Remember, pesticides can have long-term effects on your health. Sometimes, symptoms of overexposure or misuse of chemicals do not show up until long after the pesticide was used.

Poison Treatment Centers

In case of emergencies, the following list of poison treatment centers in Michigan will help you contact the nearest source of help that specializes in the treatment of poisoning. *Toll-free numbers are available in Detroit, Grand Rapids, Kalamazoo, and Marquette.*

ADRIAN

Poison Control Center
Emma L. Bixby Hospital
818 Riverside Ave. 49221
(517) 263-2412

ANN ARBOR

Poison Control Center
University of Michigan
Medical Center
1405 E. Ann St. 48109
(313) 764-5102

BATTLE CREEK

Poison Control Center
Community Hospital
183 West 49016
(616) 963-5521

BAY CITY

Poison Control Center
Bay Medical Center
100 15th St. 48706
(517) 894-3131

COLDWATER

Poison Control Center
Community Health Center
of Branch County
274 E. Chicago St. 49036
(517) 278-7361 ext. 342

DETROIT

Poison Control Center
Children's Hospital
of Michigan
3901 Beaubien Blvd. 48201
(313) 494-5711

1-800-462-6642
(within 313 area code)

Poison Control Center
Mount Carmel Mercy Hospital
6071 W. Outer Dr. 48235
(313) 927-7700

ELOISE

Poison Control Center
Wayne County General Hospital
Maryland Rd. 48132
(313) 722-3748

GRAND RAPIDS

West Michigan Poison Center
Blodgett Memorial
Medical Center
1840 Wealthy, S.E. 49506
1-800-442-4571
(within 616 area code)
1-800-632-2727
(out of 616 area code)

HOLLAND

Poison Control Center
Holland Community Hospital
602 Michigan Ave. 49423
(616) 392-5141

JACKSON

Poison Control Center
W.A. Foote Memorial Hospital
205 N. East Ave. 49201
(517) 788-4816

KALAMAZOO

Midwest Poison Control Center
1521 Gull Rd. 49001
(616) 383-7070

Great Lakes Regional Poison
Control Center
Bronson Methodist Hospital
252 E. Lovell St. 49006
(616) 383-6409
1-800-442-4112

LANSING

Poison Control Center
St. Lawrence Hospital
1210 W. Saginaw St. 48914
(517) 372-5112

MARQUETTE

Poison Control Center
Marquette General Hospital
420 W. Magnetic St. 49855
(906) 228-9440
1-800-562-9781

MIDLAND

Poison Control Center
Midland Hospital
4005 Orchard Dr. 48640
(517) 631-8100

PETOSKEY

Poison Control Center
Northern Michigan Hospitals, Inc.
415 Connable Ave. 49770
(616) 347-7373

PONTIAC

Poison Control Center
St. Joseph Mercy Hospital
900 Woodward Ave. 48053
(313) 858-7373
(313) 858-3000

PORT HURON

Poison Control Center
Mercy Hospital
2601 Electric Ave. 48060
(313) 985-9531

Poison Control Center
Port Huron Hospital
1001 Kearney St. 48060
(313) 987-5555

SAGINAW

Poison Control Center
Saginaw General Hospital
1447 N. Harrison Rd. 48602
(517) 755-1111

TRAVERSE CITY

Poison Control Center
Munson Medical Center
Sixth and Madison 49684
(616) 941-1131
(616) 947-6140 ext. 300

Self-Help Questions on Section 5 – Pesticide Safety

Now that you have studied Section 5, answer the following questions. Write the answers with pencil without referring back to the text. When you are satisfied with your written answers, see if they are correct by checking them with the text.* Erase your answer and write in the correct answer if your first answer is wrong. Note that these questions are not necessarily those that are used in the certification examination.

1. As an applicator of pesticides you have two major responsibilities in preventing accidents with pesticides. What are they?
2. Children under 10 years old are victims of at least half of the accidental deaths due to pesticides in this country. True or false.
3. How many symptoms are necessary to detect if a person has been poisoned?
4. List at least four symptoms of a "mild" organophosphate poisoning case.
5. Describe the symptoms of a "severe" case of organophosphate poisoning.
6. How are organophosphates and carbamates related in respect to poisonings?
7. Explain in detail the correct procedures for first aid in the case of a person who has swallowed a pesticide.
8. Describe the type of gloves one would wear if handling highly toxic pesticides.
9. How often should clothing, goggles and face shields be washed?
10. List three instances when a respirator is needed.
11. List the four types of respirators and when each should be used.
12. The cartridge or canister of a respirator is probably the single most important part. Its useful life depends on _____ (list).
13. What factors must one consider before buying a pesticide?
14. Reading the label of the pesticide container before you apply the material tells you _____ (list).

* The questions are arranged in the order that they appear in the text.

15. When transporting pesticides what type of vehicle is the safest?

16. Describe a safe pesticide storage area.

17. Before mixing or loading pesticides, certain factors must be taken into consideration, they are _____ (list).

18. Describe in detail the correct method for rinsing out spraying equipment.

19. Outline the procedures in cleaning up a minor spill.

20. If you accidentally spill pesticides into a water source, who should be notified?

21. Define a safe reentry time.

SECTION 6: Pesticides in the Environment

Environment means our surroundings and their many forms of life. Every plant or animal in its environment is affected by some other plants or animals there. Physical factors such as rain, temperature and wind also are a part of the environment. We cannot do much about them. Other things like waste disposal; house developments; highways; and agricultural practices, including the proper use of pesticides, can be controlled or changed.

PESTICIDES AS ENVIRONMENTAL PROBLEMS

Many people consider pesticides a tool for preserving or improving the environment. Others feel that pesticides are pollutants. Sometimes it is hard to tell which is correct. As a weed is considered "a plant out of place," a pesticide pollutant can be considered a "tool out of place."

HOW PESTICIDES HARM THE ENVIRONMENT

Applying pesticides that are not labeled for that use can cause plant injury, illegal residues or environmental damage. Even properly labeled pesticides can harm people, animals or the environment if not carefully used.

Direct Kill of Nontarget Organisms

Pesticides can injure or kill nontarget organisms by direct contact. Bees and other pollinators can be killed if a crop is treated while they are working in a field. Herbicides applied to roadside brush can drift out of the area and kill crops or ornamentals. Runoff from a recently sprayed field can kill fish in the stream or pond below the field. Aquatic life in streams can be wiped out by careless tank filling and poor container disposal. These kills can result in lawsuits, fines and loss of certification.

Persistence, Accumulation and Biological Magnification

Different pesticides act in different ways after you apply them. Most pesticides fall in one of these four categories:

1. **Pesticides that break down rapidly:** These pesticides remain on the target or in the environment only a short time before being changed into harmless products. Some are highly toxic and others are relatively harmless. All of them can be safe for the environment if used properly.

2. **Accumulative pesticides:** These are pesticides that can build up (accumulate) in the bodies of animals (including man). They may build up until they are harmful to the individual organism or to the meat eater that feeds on them.

3. **Pesticides that break down slowly:** These are called persistent pesticides. They stay in the environment without change for a long time. Often this is good, because you get long-term control. Usually these pesticides:

- do not react easily with sunlight, oxygen, or heat,
- are not broken down easily by microorganisms,
- are only slightly soluble in water, and
- can remain in the environment for many years.

Persistent pesticides do not always accumulate. Some pesticides stay in the soil but do not seem to build up in the bodies of animals. They can injure sensitive crops planted on the same soil the next year, but seem to be of little hazard to the environment outside the treated area.

4. **Pesticides that are both persistent and accumulative:** These can be hazardous if you let them escape from the target area. If persistent, they may stay in the soil, water or on the target long enough so that plants or animals are exposed to them. Even if one organism that accumulates a pesticide is not hurt by it, another animal in the *food chain* may be harmed.

"Food chain" is a term describing how all organisms depend on each other. Each animal's place in the chain depends on the type of food it eats. Animals that eat only plants are at the bottom. Animals feeding on the plant eaters are on the next level. The animals that eat meat are at the top of the chain.

Meat eaters feeding on other animals that have accumulated pesticides may be poisoned without directly contacting the pesticide. Man, as a plant and meat eater, could get high doses of pesticide in this way, although he is usually protected by residue tolerance.

Biological magnification is a term describing the concentration of pesticides at the top of the food chain. It also describes the much higher concentration of pesticides in the bodies of organisms living in an environment, usually water, that carries a very low concentration of the pesticide.

Pesticide Movement in the Environment

Pesticides become problems when they move off target. This may mean drifting out of the target area, moving on soil through runoff or erosion,

leaching through the soil, or being carried out as residues. Be careful not to let pesticides move out of the field. Apply them in a manner and at a time when they will do the least damage to beneficial organisms that use the treated area.

SOIL AND PESTICIDES

Soil gets more important as the need for food increases. Large acreages of good agricultural soil are lost to highways, housing developments, and shopping centers. We must keep the remaining agricultural land fertile and healthy. Poor soil practices and misuse cause poor yield and second-class crops, especially if root vegetables or forage crops are planted.

Overdoses of pesticides may result in sterile soil. Pesticides which remain in the soil for a long time may limit planting to only a few crops which will not be harmed by the chemicals. The whole crop rotation should be considered when a pesticide is selected.

Even pesticides deposited on the target crop move to the soil. They may be washed or brushed off, incorporated in soil with dead plant parts or eaten with plant materials by farm animals and later excreted to become pollutants.

If pesticide-treated soil stayed in place, it would be relatively unimportant as a way for pesticides to move out from the target. But poor agricultural practices may allow soil erosion. Pesticides can move out as a result of heavy rains or flash floods immediately after cultivation. Plowing under sodded areas allows for movement of pesticides on eroding soil both in water and air. Every effort should be made to prevent such soil movement.

AIR AND PESTICIDES

Air is necessary for any plant or animal to live. It is the source of oxygen for breathing and receives carbon dioxide waste. It also receives other substances and can carry them for long distances. Some of these, such as moisture that results in rain, are essential; others, such as auto exhausts, bad odors, or pesticide dusts and vapors, are disagreeable and dangerous.

Pesticide drift can cause serious environmental contamination. Pesticides in the air cannot be controlled. They can settle into waterways, neighboring crops, wooded areas, houses, or barnyards. Pesticides have been known to move across several states on prevailing winds to contaminate rainwater and soil. Even gentle breezes can carry herbicides from the target to kill or damage a sensitive crop. Air can carry the herbicide as a fine droplet that drifts a long way, or it can carry volatile formulations in the form of a gas which will drift even further. Insecticides or fungicides can be carried by drift to neighboring crops and may result in illegal residues and loss of the crop. Pesticides can drift into waterways and cause serious damage to aquatic life. The careful applicator must always be aware of the wind speed and direction and must plan his pesticide application accordingly. He must consider use of low volatile pesticide formulations and low-risk methods of application.

WATER AND PESTICIDES

Water is necessary for all life. While polluted water can be used for many of our needs, we cannot drink it or bathe in it. Most fish and other marine life can survive only slight changes in their water environment.

Even tiny amounts of many pesticides can harm fish and other marine life. Marine life can be killed outright by pesticides in water, or there may be chronic effects. The behavior of the affected organism can be changed so that predators can more easily catch and kill it. Pesticide-contaminated eggs may not hatch or young organisms may not survive after hatching.

Polluted irrigation water may stunt or kill crops, result in illegal residues, or otherwise make the soil unfit for use. It can harm or kill livestock or taint milk or meat so that it cannot be used.

Most pesticide movement through air or soil ends up in water. Most of the residue problems affecting wildlife have been caused by pesticides in water. Avoiding pesticide contamination of water is particularly important in avoiding accumulation and biological magnification, as well as in preventing serious fish kills.

Water can be contaminated by pesticides in many different ways. Pesticides are applied directly to water when controlling pests such as mosquito and blackfly larvae, aquatic weeds and trash fish. This can be done fairly safely if you choose the pesticides carefully, check to be sure they are registered for the use intended and apply them carefully. But water can be grossly contaminated if the wrong pesticide is carelessly applied. You must check to see if permits are required to apply pesticides to water in your state.

Pesticides also can be applied directly to water through carelessness. Drift, spills, back-siphoning

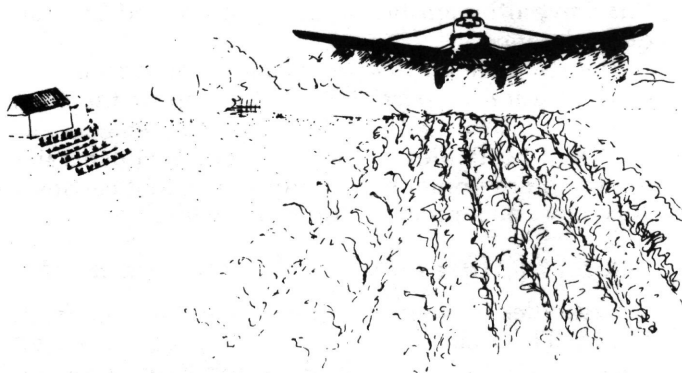

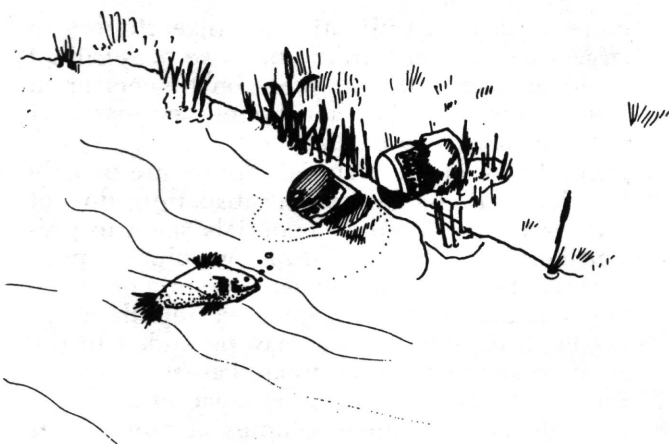

from sprayers, and poor disposal of containers and surplus pesticides all contribute to direct water contamination. Often the tank filling station for the sprayer is on the bank of a stream or pond where spills from an overfilled tank can run directly back into the water. The sprayer should never be left unattended while the tank is being filled. The tank filler also should be equipped with some kind of antisiphoning device to prevent backward flow of spray materials into the water source. "Empty" pesticide containers that are not completely empty must be accounted for and returned to storage for disposal. Otherwise they and the pesticide within them are likely to end up in the water. Leftover spray should never be emptied down the storm sewer. This is a direct path to water.

Erosion — both by water and wind — leaching and runoff are means by which pesticides reach water indirectly. Pesticides often stick tightly to the soil. As long as the soil stays in place, the pesticide stays in place. But poor agricultural practices that lead to erosion lead to pesticide movement into water.

Heavy rains or flooding just after a pesticide application can wash pesticides from the target and into the water. One should not apply just before or during heavy rains. Pesticides also may reach water by leaching down through the soil, but this is not a major source of contamination.

SENSITIVE AREAS

Sensitive areas are those such as parks, playgrounds, bird sanctuaries, ponds and streams, water supplies, barnyards and feed lots, pastures, bee yards, school, homes or any other areas where out-of-place pesticides might cause damage. The pesticide applicator must be sure that the dose does not expose and pollute these areas when applying pesticides nearby.

Water

Water of any kind represents a sensitive area. You must be very careful not to contaminate it, whether it is used for drinking, bathing, irrigation, fishing or as a wildlife habitat.

Wildlife

Wildlife, such as fish, birds and mammals, is an asset to man. Take care to protect nearby wooded areas and waterways when applying any pesticide. If pesticides are improperly used or allowed to move out of the treated area, hunting and fishing could disappear. Improper use could lead to high levels of pesticides in the bodies of some of these animals, making their meat unfit and illegal to eat.

Large area pesticide control programs for such things as mosquito abatement, forest insects and roadside brush and weeds may harm many non-target organisms within the treated area. Such projects must be very carefully planned.

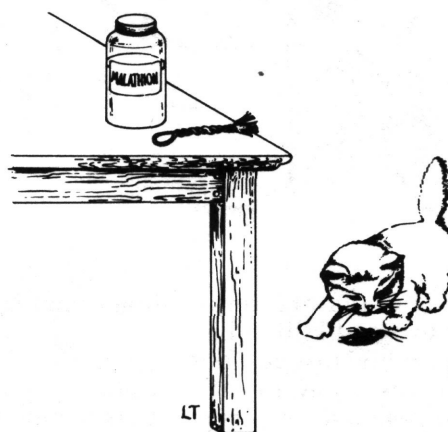

Barnyards, Feed Lots and Pastures

Barnyards, feed lots and pastures where domestic animals drink or graze can lead to problems with pesticides. Some farm animals have been killed outright by eating contaminated feed or forage or drinking contaminated water. Meat and milk from others has been made unsalable by the residues from careless pesticide use which exceeded legal tolerance.

PESTICIDES AND BEES

Michigan's bees produce 8 to 10 million pounds of honey a year, worth about \$1.5 million. The total value of commercial and "backyard" crops pollinated by bees in Michigan is about \$100 million.

For most of the crops, commercial production without bee pollination would be impossible.

Pesticide damage to bees takes many forms. Colonies may be completely destroyed, but most commonly, only field bees are killed. Loss of field bees can be serious because the factor contributing most to a beekeeper's success in honey production or pollination is his ability to build up colonies that are strong in numbers of bees. If the field force is destroyed by pesticides, the whole colony will be weakened and may remain weak for some time.

The present challenge is to determine how and when to use pesticides, and which pesticides and

supplementary control measures to use, so that pests may be most adequately controlled without killing bees.

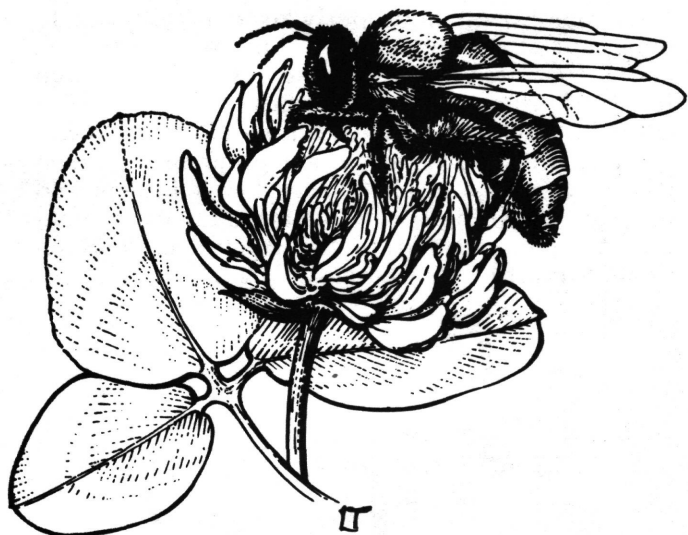

Following is a brief interpretation of precautions necessary to avoid killing bees:

1. Not applying insecticides to crops in bloom. Don't allow spray to drift to plants in bloom. Drift to nontarget plants accounts for most bee-kill.
2. Timing the application of insecticides. Ideally, pesticides should be applied when there is no wind and bees are not "working" plants in the area. Little damage will result if the crop is sprayed late in the afternoon with a spray that breaks down in a few hours. In general, evening applications are least harmful to bees.
3. Variable toxicity of insecticides. Nearly all agricultural pesticides have been laboratory tested and rated for their toxicity to bees. A list of insecticides, rated according to their toxicity, is included at the end of MSU Cooperative Extension Bulletin E-678. When there is a choice of pesticides, use those least toxic to bees. In general, granular applications are not harmful to bees.
4. Puddles of spray and spray in the water supply. Bees gather water to drink and to regulate temperature and humidity within the hive. Care should be taken not to let spray drip and form puddles, accumulate in wheel tracks or to be exposed in any way.
5. Air vs. ground application. Air application of insecticides is more dangerous to bees than ground application, chiefly because the material drifts greater distances and is applied much

more rapidly. Application of insecticides to large areas may be harmful because bees cannot avoid contact with the spray on flowers or in water. Total wild bee and honey bee loss over the large area may be sizable.

6. Formulation of the material. Sprays are usually less harmful than dusts because they do not drift as much. Granular materials seem to present very little hazard. Ultra-low-volume applications of some materials have been more toxic than regular sprays. No effective repellent has yet been developed that may be added to the spray to keep bees from treated areas.
7. Follow official spray recommendations.
8. It is not easy to move colonies of honey bees from an established apiary. Beekeepers should not be expected to move colonies and suffer honey production loss unless there is no alternative.

SCHOOLS, PLAYGROUNDS, HOMEGROUNDS AND PARKS

Schools, playgrounds, homegrounds, and parks and other such areas should always be considered as places requiring special caution. Pet dishes, sandboxes, playground equipment and toys can receive a dangerous amount of off-target pesticide. Pesticides used in or around such areas should be the safest ones available that are effective.

BENEFITS OF CAREFUL USE

Pesticides help the environment when they are used carefully and wisely. Even in sensitive areas the careful choice and expert application of a pesticide may do little harm to the environment. When properly used, pesticides can help produce better quality and high yields of food by reducing damage from insects, diseases and weeds. Thus, more land is left free for recreation and wildlife.

Pesticides can improve the enjoyment of recreation areas through control of annoying pests. They can improve the quantity and quality of livestock products. They can control runaway epidemics of newly introduced insects and diseases. And they can be harmless to plants and wildlife when properly used.

Weigh carefully the advantages and disadvantages of each pesticide use. Choose the pesticide that will do the least damage to nontarget organisms while giving good control. Finally, plan each part of the job carefully from beginning to end.

Self-Help Questions on Section 6 – Pesticides in the Environment

Now that you have studied Section 6, answer the following questions. Write the answers with pencil without referring back to the text. When you are satisfied with your written answers, see if they are correct by checking them with the text. Erase your answer and write in the correct answer if your first answer is wrong. Note that these questions are not necessarily those that are used in the certification examination.*

1. *Define the word environment.*
2. *What are some characteristics of persistent pesticides?*
3. *What is a "food chain"?*
4. *Describe the relation between the air and the pesticide.*
5. *How do pesticides affect a water source?*
6. *Define a "sensitive area."*
7. *When should one apply pesticides if honeybees are in the area?*
8. *What precautions should be taken to protect wildlife in a spray area?*
9. *What formulations of pesticides are the safest to use around honeybees?*

*The questions are arranged in the order that they appear in the text.

SECTION 7: Pests

INSECTS, SPIDERS, MITES AND TICKS



Insect Characteristics

Insects thrive in more environments than any other group of animals. They live not only on the earth's surface but within the earth, in the air, and in water. They are at home in deserts, rain forests, hot springs, snow fields, and dark caves. They eat the choicest food of man's table and can even eat the table.

There are about 30 orders (groups) of insects, but for our purpose, we will consider only the 13 orders containing the majority of pest species.

The most important parts of an insect to consider in classifying it are its wings and mouthparts. Insects with chewing mouthparts have mandibles. These are toothed "jaws" that bite and tear the food. Insects with piercing-sucking mouthparts usually have an elongated beak that contains a tubelike organ which is forced into a plant or animal to suck out fluids.

Many insects (such as moths, butterflies, beetles, flies, bees, wasps, and ants) differ in appearance throughout their development. The larval stage is usually a grub, caterpillar, or wormlike creature. This is the stage in which most of their growth occurs and often most damage is done. The adult stage usually has wings and always has six jointed legs. Between the young and adult stages is an inactive pupal stage in which the young transforms to the adult.

Insect Damage

Insects cause damage to plants by chewing off foliage; by tunneling or boring in stems, stalks, and branches; by pruning off and tunneling in roots; by sucking the sap from leaves, stems, roots, flowers, and fruits; by transmitting plant diseases. These activities result in killed, weakened, and/or disfigured plants which in turn cause reduced yields, lowered quality, and unmarketable plants or plant products. Even after harvest, insects continue their damage in stored or processed commodities.

Insects also feed on and in man and other animals. Some of these pests carry diseases which cause millions of deaths each year. One example is the mosquito that transmits dog heartworm. Some insects, like deerflies, inflict painful bites. Others, such as houseflies, do not feed on man or animals but may cause considerable annoyance.

Great quantities of food are consumed and/or contaminated by insects each year. Who has not thrown away food because it contained an insect?

Even the houses we live in and the clothes we wear may be attacked by insects. Termites are a well-known example of wood destroyers, but there are also insects that can chew through such things as plastic, cinder blocks, and even lead. Clothes put away for the season may be destroyed if proper precautions are not taken.

Identification of Major Insect Groups

Most applicators learn to recognize the most important insect pests associated with their job. Occasionally, unfamiliar, or new pests, may appear. Identification aids, publications and pictures are available to help identify unknown pests. But the best thing to do is to call on local experts such as the Cooperative Extension Service or competent consultants for accurate identification.

Applicators should be familiar with representatives of the major insect groups of economic or medical importance and the type of damage typically done by each group.

Bristletails: Wings always absent; mouthparts chewing; usually with long tails; young and adult

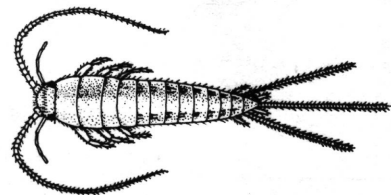

similar in appearance. Usually found in houses, cement and cinderblock buildings, they feed on all sorts of substances such as book bindings, wallpaper, and labels. Firebrats and silverfish also belong in this insect order.



Chewing lice: Wings always absent; mouthparts chewing; head broad; young and adult similar in appearance. They attack almost every kind of wild or domesticated bird. On poultry, they cause weight loss and reduced egg production.

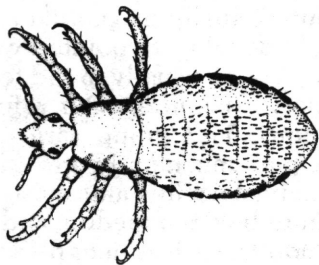

Sucking lice: Wings always absent; mouthparts piercing-sucking; head narrow; young and adults similar in appearance. Usually found feeding on cows and hogs. Human body and head lice and the pubic louse (crab) also being in this order. Body lice can transmit several very serious human diseases. Their bites are painful to man and animals.

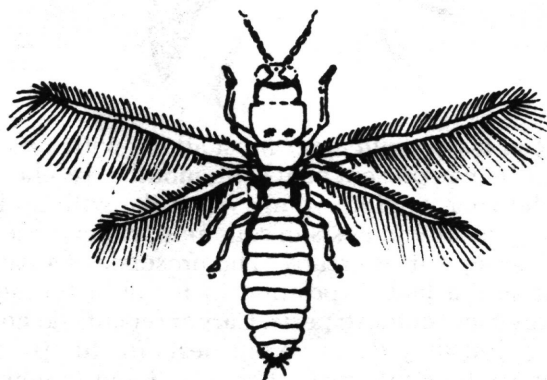

Thrips: Wings absent or present (when present, they have long fringe); mouthparts rasping-sucking; young and adults similar in appearance; small insects. Usually found in flowers or buds of plants. Misshapen or poorly developed flowers or buds may result.

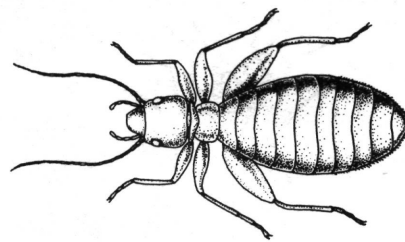

Termites: Wings absent or present (when present, the four wings are about equal in size and shape) mouthparts chewing; young and adults similar in appearance; look somewhat like white ants. Usually found feeding on dead trees or wood products that touch or are near the soil, such as fence posts, timbers, and flooring. Heavy damage to the wood in homes and other structures is common in many states.

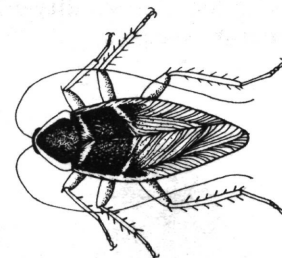

Grasshoppers, crickets, and cockroaches: Wings absent or present (when present, top pair leathery); mouthparts chewing; young and adults similar in appearance. Grasshoppers and crickets are usually found in the field feeding on plants and may cause heavy damage to leaf surfaces and reduction in crop yields. Roaches frequently occur indoors (kitchens, bathrooms, restaurants, offices, stores). They are unsightly and may spoil stored food.

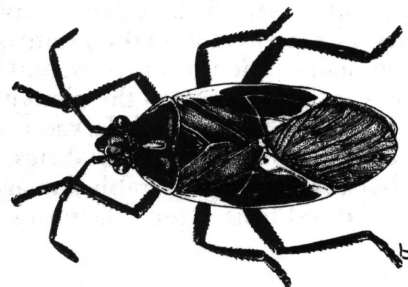

True bugs: Wings absent or present (when present, top pair part leathery and part membranous); mouthparts piercing-sucking; young and adults similar in appearance. Usually found sucking the juice from plants. They may reduce the vitality and yield of the plant and carry plant diseases. Boxelder bugs, stink bugs, and chinch bugs belong in this order. Bed bugs, which may be found in houses, hotels, and other living quarters sucking blood from man and other animals, are also true bugs.

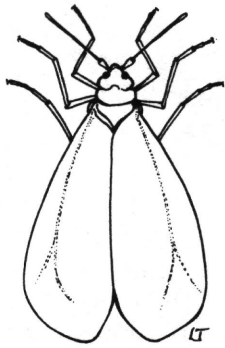

Aphids, whiteflies, leafhoppers, spittlebugs, and scale insects: Wings absent or present; mouthparts piercing-sucking; young of aphids, whiteflies, leafhoppers, and spittlebugs are similar to the adults; young of scale insect looks like typical insect, but adult females are stationary and are covered with a convex shell. Usually found sucking the juices from plants. They may reduce the vitality and yield of the plant and carry plant diseases.



Moths and butterflies: Adults usually with large wings that have many scales that rub off easily; mouthparts of adults siphoning (coiled tube); young are wormlike, usually with three pairs of jointed legs and five pairs of soft, fleshy legs; larvae have chewing mouthparts. The larval stage of this group is an important pest on many agricultural crops, and damage to leaf surfaces and other parts of the plant may greatly reduce the yield. Clothes moth larvae ruin clothes, upholstered furniture, and other fabrics. Larvae of other moths can cause considerable damage in stored grains, nuts, dried fruits, candy factories, etc.

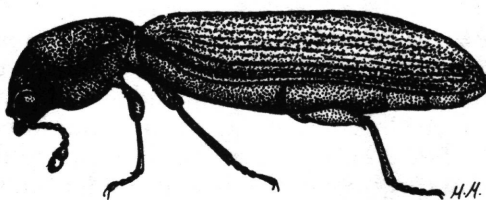

Beetles: Adults with top pair of wings usually hard; mouthparts chewing; young grub or wormlike, legless or with six legs, and have chewing mouthparts.

There are many different types of beetles and the group has a wide host range. They attack crops, wood, fabrics, stored products, and foods. Both adults and larvae can cause damage. Powder post beetles, the boll weevil, lightning bugs, rose chafers, and granary weevils are just a few members of this large group.

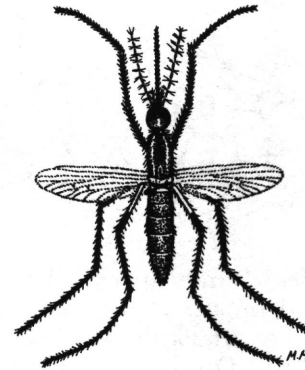

Flies and mosquitoes: Adults with only one pair of wings (winged insects of other groups have two pairs); adult mouthparts are sponging or piercing-sucking; young usually maggotlike; head of young usually poorly developed, pointed with small, dark mouth hooks. Young usually found feeding on plant seedlings, roots, in manure, water, refuse, and various damp situations. This group varies greatly. Some adults with piercing mouthparts carry disease to plants and animals. Flies and mosquitoes in large numbers can reduce the feeding and weight of animals. Some adults, such as deer flies and black flies, have painful bites. Midges and gnats are also members of this group.

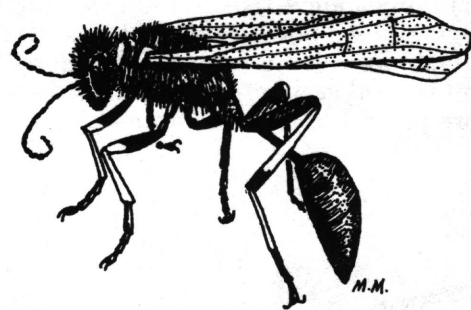

Bees, wasps, and ants: Most adults with a narrow waist; wings present or absent; mouthparts chewing or chewing-lapping; young wormlike with no legs. Young usually in nests in soil, mud, paper, wax, etc. This group varies greatly. The presence of a painful sting and a bad disposition in many of the adults makes some of these pests. Carpenter ants do not eat wood, but they do carve out nests in stumps, telephone poles, building timbers, etc. Some members of this group, especially bees, are important plant pollinators.

Fleas: Wings absent; mouthparts sucking; adults laterally flattened; larvae whitish and legless. Adults

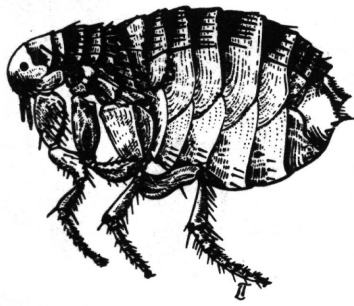

usually found sucking blood from birds or mammals. Some fleas can transmit diseases such as bubonic plague or endemic typhus.

Identification of Spiders, Mites, and Ticks

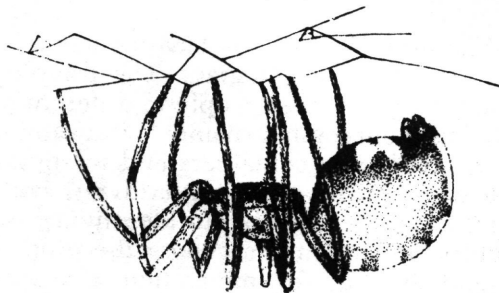

Spiders: Spiders are a diverse group of animals with eight jointed legs. Mouthparts are sucking. Spiders vary in size from a fraction of an inch to five or six inches. Two species dangerous to man are the black widow and the brown recluse. Spiders are useful to man because they feed on insects, but their webs and excretions may be a nuisance.

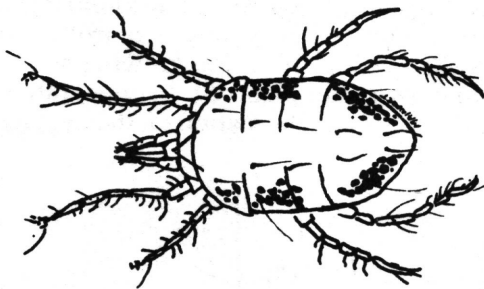

Mites: Mites are spiderlike animals, usually with eight jointed legs as adults. They are always very small. Wings absent; mouthparts sucking; body soft; young and adults similar in appearance.

Because mites are so small, the plant injury they cause usually is found before the mites are noticed. When mites are present in large numbers, their feeding turns foliage and buds whitish, reddish, or brown. Some kinds when numerous produce thin webs on plants. Other mites are pests of livestock, poultry, and dogs. Their bites are an annoyance factor that can result in a loss of productivity. Chiggers (or jiggers) and red bugs that attack man are also mites.

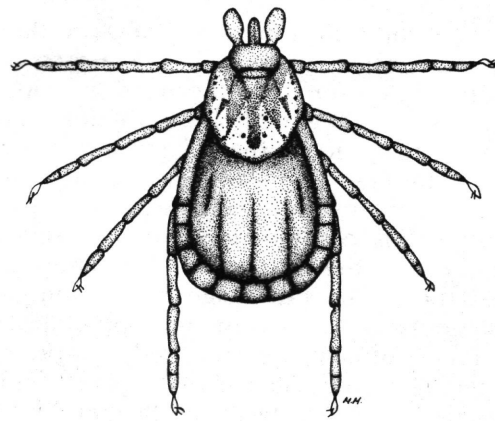

Ticks: Ticks are spiderlike animals with eight jointed legs as an adult. They are all parasitic on animals and must have a blood meal to complete their life cycle. Ticks have a leathery, colored body without a distinct head; with well-developed mouthparts they firmly attach themselves to the host animal. Some ticks carry disease to man and animals.

Principles in Controlling Insects, Spiders, Mites, and Ticks

Effective control is based on knowledge of the pest's growth habits.

Pests are subjected to limiting factors, or hazards, during their lives. These forces may hold the numbers of a pest below the level where serious damage occurs. But when natural events, farming methods or other human activities reduce the effects of these limiting factors, pest numbers may rise to the level where damage may occur. The challenge lies in our ability both to manage plants and animals so that injury caused by pests is held to a minimum, and to recognize when more direct action, such as pesticide application, is necessary.

The control of insect pests or the damage they do can be considered from two viewpoints. One is a short-term, direct sort of action. The other is a long-range, damage prevention program. Either type may be needed, depending on the circumstances. As needed information becomes available, we should strive toward management systems which will approach the idea of damage prevention.

Whether short- or long-term, an effective pest control program should follow some logical procedure.

Detection: Too often, controls are attempted after the damage is done. It is important to develop and maintain a survey or detection plan to give early warning of pest populations. Some of this warning is made available by the Cooperative Economic Insect Survey operation in most states. Regular termite inspections, pest management projects, scouting programs, and individual grower vigilance are other techniques.

Damage can show up before the pest responsible is noticed. In these cases, it is necessary to make a

diagnosis to determine if the symptoms are due to insects or some other cause.

Economic evaluation: Just because a properly identified insect is chewing holes in the leaves of a plant doesn't always mean that a loss in quantity or quality will follow. An applicator may spend more to buy a pesticide than would have been lost through insect damage. It is therefore necessary to determine the significance of the infestation. This is done by considering the numbers and stage of development of the pest, stage of growth and economic potential of the plants, numbers of parasites and predators present, weather conditions, ultimate use of the plants, and all the other many factors that may affect the impact of the pest. In many cases, economic thresholds have been determined. In these instances, the crop or commodity should be surveyed by the grower, scout, or inspector to accurately determine the pest population. This then becomes one of the important pieces of information to use in making a decision.

Knowledge of life habits of pests: If the pest found is new to the area, research or observation of it may be needed in order to develop control methods. This process may range all the way from making a few observations to a long-range, complex research project.

Development and improvement of control methods: Accurate information about the habits and economic importance of a pest will help you select the best combination of practices to minimize damage. With experience, you will find which techniques work best for the specific location and situation. This process also may be very simple, or it may be highly complicated and take many years.

Prescription or recommendation: Ultimately, a decision must be made based on all the information available. This may be a recommendation to a farmer by a professional advisor or consultant, a legal type of order by a government official, or simply a decision made by a homeowner after making observations in his house or garden. The decision may involve a long-range management program or the selection of a certain rate of pesticide. When the use of a pesticide is decided to be necessary, it is essential to apply the right pesticide at the right time in the right place at the right rate. If any part of a total management program is missed, the whole job may fail.

WEEDS

Characteristics

A weed is most simply defined as "a plant out of place." Weeds are responsible for huge expenditures of energy and money every year. Estimates of annual costs range above \$5 billion.

Weeds are a problem because:

- land use is less efficient
- product quality is reduced
- crop yields are reduced

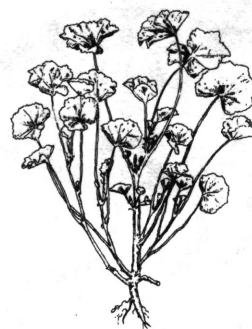

- the beauty of turf and ornamental plants is destroyed
- they obstruct right-of-way areas, and
- enjoyment of outdoor recreation is diminished.

Identification of Weeds

Weed names: Most weeds have common names such as cocklebur or crabgrass. The trouble with "common names" is that people in different places often use different common names for the same plant. Labels on herbicide containers and in supporting literature generally use standardized common names. You need to be able to identify a weed by common name so you can choose the proper herbicide and find control information in supporting publications.

Life cycles: Before you can control weeds, you need to know something about how they grow. One way to identify plants is on the basis of the length of their cycle.

1. *Plants with a one-year life cycle - annuals.*

These plants grow from seed, mature, and produce seed for the next generation in one year or less. Whether they are grasslike (crabgrass and foxtail) or broad-leaved (pigweed and cocklebur), they are easy to control when young. Control measures should be used early in the growing season not only to destroy the plants of that generation, but also to prevent seed formation for the next generation.



Summer annuals are plants that result from seeds that germinate in the spring, grow, mature, produce seed and die before winter of each year.

Examples include crabgrass, foxtail, cocklebur, pigweed and lambsquarters.



Winter annuals are plants that grow from seeds that germinate in the fall, grow, mature, produce seed and die before summer of each year. Examples include henbit, sticktight, pennycress (stinkweed), and common chickweed.



2. *Plants with a two-year life cycle – biennials.*

These plants require two years to complete their life cycle. They grow from seed that germinates in the spring. They develop a heavy root and a compact rosette or cluster of leaves the first summer. Biennials remain dormant through the first winter and in the second summer they mature, produce seed and die before winter. Examples include mullen, burdock, bull thistle, Queen Anne's lace (wild carrot), teasel, and wild parsnip.



3. *Plants which live more than two years and may live indefinitely – perennials.*

These plants may grow from seed, but many produce tubers, bulbs, rhizomes and stolons. The aboveground portions of these plants may die back each winter, but they develop new aboveground parts each spring. Examples include Johnsongrass, field bindweed, dandelion, hawkweed, plantain, goldenrod, and poison ivy.

Perennial plants also can be further grouped as follows:

Creeping perennials produce seeds but also produce rhizomes (belowground stems) and stolons (aboveground stems). Examples include Bermuda grass, Johnsongrass, field bindweed, and ground ivy.



Simple perennials produce seeds each year as the normal means of reproduction, but in some instances root pieces may produce new plants following mechanical injury during cultivation. Examples include dandelions and plantain.

Bulbous perennials produce seed and bulbs which can form aboveground bulbs like wild garlic or belowground bulbs like wild onions.

Principles of Weed Control

Here are some common terms you should know before planning weed control:

Selective herbicide: an herbicide that is more toxic to some kinds of plants than to others. The degree of selectivity is affected by plant age, rate of growth, form of the plant, and physiology.

Nonselective herbicide: an herbicide that is toxic to all plants. Some nonselective herbicides may be made selective to some plants by varying the dosage, by directing the spray to a specific site, or by the choice of spray additives such as wetting agents. Selective herbicides may be made nonselective by manipulating the same factors.

Contact herbicide: an herbicide that is directly toxic to living cells upon contact. These herbicides destroy only the aboveground parts of plants and are effective against any annual weeds.

Translocated herbicide: an herbicide which may be absorbed by leaves and stems and/or roots and be moved throughout the plant. Root absorption and translocation occurs in the water-conducting tissues (xylem). Leaf or stem absorption and translocation occurs primarily in the food-conducting tissues (phloem).

Soil sterilant herbicide: A nonselective herbicide that kills all plants and prevents re-establishment of weeds for a relatively long period of time.

The following terms concern the time of application of herbicides.

Pre-emergence: applied to the soil before crops and weeds emerge. May also refer to applications after

crops emerge or are established but before weeds emerge.

Preplant: applied to the soil before the crop is planted and before weeds emerge.

Postemergence: applied after the crop and weeds emerge.

PLANT DISEASES

Characteristics

A plant disease is any condition in which a plant is different from a normal (healthy) plant in either structure or function. The diseased plant may be shorter or have more branches or fewer leaves than normal — it differs in structure. It may wilt and die prematurely, or not produce flowers or fruit — it differs in function.

To be a plant disease, the condition must have four main features. Disease is a *process*. It does not occur instantly as does an injury. It is *physiological*, affecting all or part of the functions of the plant. It is *abnormal* to the plant. It is *harmful* in some way, even though this is not always immediately detected.

Three ingredients must be present for a disease to develop:

- a susceptible host plant,
- a disease-producing agent (the pathogen), which may be living or nonliving,
- an environment favorable to disease development.

Causes of Plant Diseases

The definition of plant disease is very broad and includes all possible causal agents, including insects, as long as the four criteria cited above are satisfied. For example, insects that produce galls on plant parts are true causal agents of disease. Insects, however, are generally omitted from the area of plant disease and covered in the field of entomology.

Plant diseases are divided into two broad groups based on their cause.

1. *Nonparasitic diseases* are caused by some nonliving agent such as nutrient deficiency, extreme cold or heat, toxic chemicals (air pollutants, weed killers, too much fertilizer), mechanical damage, lack of water, adverse genetic changes, and many others. These diseases cannot be passed from one plant to another. Their control depends solely on correcting the condition (usually something in the environment) causing the disease.
2. *Parasitic diseases* are caused by living organisms which live and feed on plants. The most common causes of parasitic diseases are fungi, bacteria, viruses, and nematodes. A few seed-producing plants such as the mistletoes also can cause plant diseases.

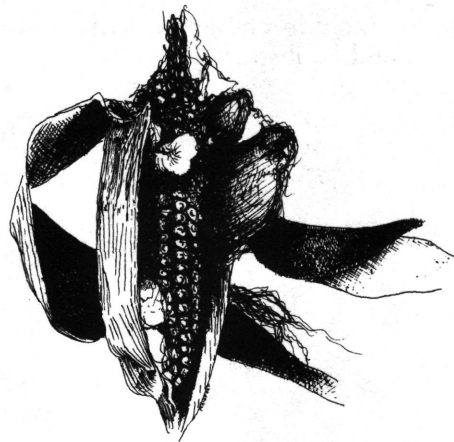

Fungi: are plants that lack the green coloring (chlorophyll) found in seed-producing plants, so they cannot make their own food. There are more than 100,000 kinds of fungi of many types and sizes. Not all are harmful, and many are helpful to man. Most are microscopic, but some, such as the mushroom, are quite large.

Most fungi reproduce by spores, which vary greatly in size and shape. Some fungi produce more than one kind of spore, and a few fungi have no known spore stage. Most live on dead organic matter which they help to decompose. Fungi that attack wood products fall into this category, and they can be serious pests. Several species can cause diseases, mainly of the skin, in man and animals. All plants may be attacked by some kind of fungi. Powdery mildew, anthracnose, dry rot, damping-off, and Dutch elm disease are all caused by fungi.



Bacteria: are very small, one-celled plants that reproduce by simply dividing into two equal halves. Each half becomes a fully developed bacterium. This type of reproduction may lead to rapid buildup of a population under ideal conditions. Some bacteria, for example, can divide every 30 minutes. In 24 hours, a single cell could produce 281,474,956,710,656 offspring. Fire blight and some soft rots of vegetables are caused by bacteria.



Viruses: are so small that they cannot be seen with an ordinary microscope. They are generally studied and identified by their effects on selected “indicator” plants. Many viruses that cause plant diseases are carried from one plant to another by insects, usually aphids or leafhoppers. Viruses cause serious problems in plants that are propagated by bulbs, roots, and cuttings because the virus is easily carried along in the propagating material. Some viruses are easily transmitted by rubbing leaves of healthy plants with juice from diseased plants. This may often occur in greenhouses when an operator touches an infected plant and then handles others. A few viruses are transmitted in pollen. Big vein virus of lettuce is transmitted by a soil-borne fungus, and a few viruses are transmitted by nematodes. Tobacco mosaic, cucumber mosaic, and necrotic ring spot of stone fruits are viral diseases of plants.



Nematodes: are small, usually microscopic, wormlike creatures that reproduce by eggs. Their rate of reproduction depends largely on soil temperature, so nematodes are usually more of a problem in warmer areas. They usually do not kill plants, but reduce growth and plant health.

All nematodes on plants have a hollow spear which they use to puncture plant cells and feed on the cell's

contents. Nematodes may develop and feed either inside or outside of a plant. A complete life cycle involves egg, four larval stages and adult. The larvae usually look like the adults, but are smaller. The root knot nematode deposits its eggs in a mass outside of its body. The cyst nematode keeps part of its eggs inside its body, where they may survive for many years.

Some nematodes attack man and animals. Examples of these are dog heartworm, pinworm, and hookworm.

Development of Plant Diseases

Parasitic diseases depend on the life cycle of the parasite. This cycle is greatly influenced by environmental conditions, especially temperature and moisture. They not only influence the activities of the disease organism but also affect the ease with which a plant becomes diseased and the way the disease develops.

The life cycle of a pathogen begins with the arrival of some portion of it (fungus spore, nematode egg, bacterial cell, virus particle) at a part of the plant where infection can occur. This step is called *inoculation*. If environmental conditions are favorable, the parasite will begin to develop. This stage is called *incubation*. If the parasite can get into the plant, the stage called *infection* starts. The stage in which the disease spreads more or less extensively into the tissues of the host is called *invasion*. The plant is diseased when it responds to the invasion of the pathogen in some way.

A diseased plant—like a person—generally shows some symptoms. A disease often gets its name from the plant's symptoms. The three general types of symptoms are:

- overdevelopment of tissue such as galls, swellings or leaf curls.
- underdevelopment of tissue, such as stunting, lack of chlorophyll or incomplete development of organs.
- death of tissue such as blights, leaf spots, wilting and cankers.

Identifying Plant Diseases

You cannot always identify a plant disease from the symptoms alone. Because several different diseases may cause the same symptoms, other evidence is needed. Looking at the signs — the structures of the pest — is a better way to identify the disease. Signs include such things as fungus spores, nematodes or their eggs, and bacterial ooze. You usually need a microscope or magnifying lens to see the signs. You need more training to find and identify signs than you need to observe symptoms.

Principles of Control

To control plant disease, you must first consider the three items involved in the disease.

1. the host plant,
2. the pathogen, and
3. the environment.

In addition, you must also consider the cost.

Not all control measures work for all kinds of pathogens. Some hosts will not tolerate some controls, and the environment limits the kind of control measure and the time it may be used.

One system of categorizing methods of plant disease control is as follows:

- avoidance of the pathogen,
- exclusion of the pathogen,
- eradication of the pathogen (and its vectors), and
- protection of the host from the pathogen.

Avoidance and protection are both aimed at helping the plant keep the pathogen away. Exclusion and eradication are directed at the pathogen itself by either killing or preventing it from reaching a host.

VERTEBRATES

Characteristics

All vertebrate animals have a jointed spinal (vertebral) column. These "higher" animals include fish, snakes, turtles, alligators, lizards, frogs, toads, salamanders, birds and mammals. As there is a closer relationship between man and the other vertebrate species, the general public is more reluctant to kill members of this group than the lower life forms like plants and insects. What may be a pest under some circumstances may be a highly desirable form under others.

Damage Recognition

Fish: Most of our fish problems are man-induced as we have attempted to put various species in places where they would not have occurred normally. Some kinds of fish are considered undesirable because they are not useful for sport or for food, or because they are harmful to more desirable species. Fish that serve as intermediate hosts for some parasites of man may cause human health hazards.

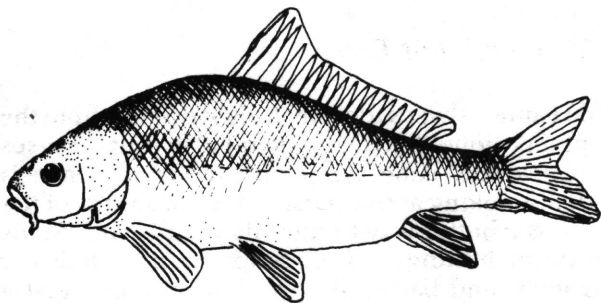

Reptiles and amphibians: Reptiles (snakes, lizards, turtles and alligators) and amphibians (frogs, toads and salamanders) may cause local

problems. The reaction against these animals is more psychological than economic. However, poisonous snakes and turtles in fish hatcheries or waterfowl production areas can be a real problem.

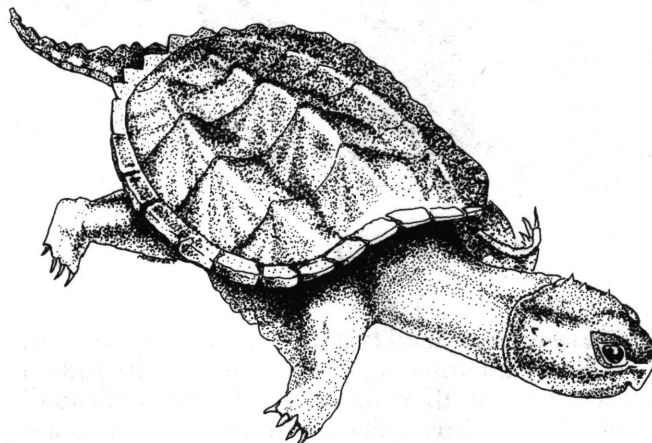

Birds: Damage can be quite varied, including structural damage by woodpeckers; killing of fish, livestock, poultry, or game species; or destruction of fruit, nut, grain, timber, and vegetable crops; and hazards to animal and human health. Peck marks, location of damage, tracks, feathers, droppings and a general lack of sign as the item has been carried away form the bases for determination of bird depredation.

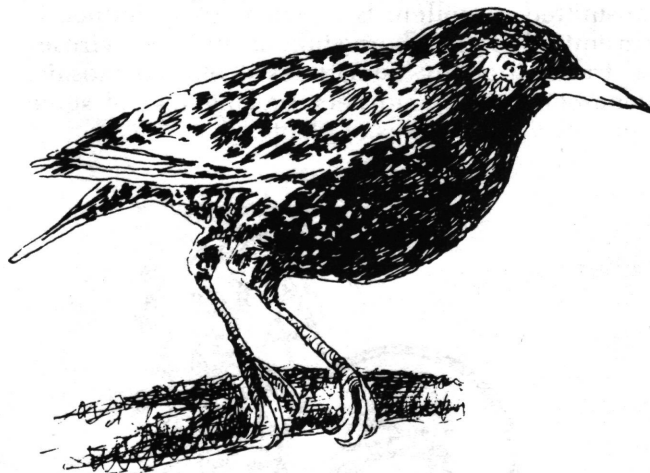

Mammals: Damage by mammals is as varied as that done by birds. Livestock and human health problems are even more important. Diseases that mammals transmit to man include rabies, plague, typhus, food poisoning, leptospirosis, and tularemia. Killing of other animals by mammals is costly, particularly on larger livestock. Mammals



also do significant damage to fruit, vegetable, nut, grain, range and tree crops. Their interference with water-retaining structures and flooding of areas can be of extreme economic concern. They damage such things as lawns, clothing, furniture and buildings by gnawing and burrowing.

How do you tell which kind of mammal was responsible for a particular type of damage? You can eliminate some suspects if you know which animals are found in your part of the country, what kinds of places they live in, and what their habits are. Animal signs (tracks, droppings, toothmarks, diggings, burrows, hair and scent) plus the type of damage will give you further clues to the culprit.

Principles of Control

To solve vertebrate pest problems, the applicator must:

- recognize damage patterns and the species of animal responsible,
- know the physical characteristics of life habits of most animal species present in a given situation,
- be aware of the control measures available that would be effective, selective, humane, and cause the least possible environmental damage,
- know the local, state and federal regulations that apply to the situation, and
- realistically evaluate the risks and benefits of the available control measures.

PLANT GROWTH REGULATORS, DESICCANTS AND DEFOLIANTS

Principles in Use

Plant growth regulators, desiccants and defoliants are not used to control insects, disease organisms or weeds in the ordinary sense. But because of their chemical nature, they are classified as pesticides by federal law.

Plant growth regulators are chemicals that in small amounts promote, inhibit, or otherwise modify either or both the vegetative or reproductive processes of plant growth. For example, these organic chemical compounds are used to control the height of plants, stimulate the rooting of cuttings, decrease preharvest drop of fruits, control suckering of plants, prevent or delay sprouting of tubers and promote dense growth of ornamental plants.

Desiccants are chemicals that dry up and kill the leaves and stems of plants. Usually, desiccants are used to remove foliage to facilitate the harvesting of crops such as cotton and potatoes.

Defoliants are chemicals that cause leaves of plants to drop without immediately killing the entire plant. Like desiccants, defoliants are used to remove foliage to make the harvesting of crops such as cotton and soybeans easier.

Antitranspirants are chemicals used to coat the leaves of plants to cut down on water loss (transpiration). They also are used to prevent winter damage, maintain color in evergreens and protect against salt damage.

Mode of Action

Most plants are composed of roots, stems, leaves, flowers and fruits. These plant parts are made of tiny cells which continually multiply and grow during the life of the plant. Plant growth regulators speed up or slow down the multiplication and growth of these cells. In this way, they change the vegetative and reproductive processes. For example:

- Standard chrysanthemums often have an elongated stem just below the flower. This causes flowers to break off. Plant growth regulators applied to the proper stage of growth will slow down cell division and elongation causing the stem to be shorter.
- Plant growth regulators are used on apples to decrease preharvest drop, increase fruit firmness, reduce scald, delay water core (water-soaked area around core of fruit), increase red color, thin fruit, increase flowering, reduce fruit cracking and promote uniform bearing of fruit.
- To increase both the quality and yield of tobacco, the top of the stem is removed. This practice (called topping) causes suckers (lateral stems or branches) to begin to grow. If these suckers remain on the plants, both quality and yield will be reduced. Therefore, they must be removed by hand or by use of plant regulators.
- Turfgrass growth in hard-to-mow areas, such as under fences, around posts and on steep banks, are treated with plant growth regulators to reduce growth.

Desiccants and defoliants often are called harvest-aid chemicals, because they help the farmer harvest his crop. Desiccants kill or dry up the leaves and stems of plants. Defoliants are absorbed by plant leaves and cause them to drop while they are still green without immediate killing of the plant. Both desiccants and defoliants are used to eliminate leaves, stems and weeds in cotton, soybeans and potatoes.

Hazards

The *rate* and *time* of application of plant growth regulators are critical. They are effective at very low concentrations. Used at excessive rates, they usually damage plants severely or even kill them. Plant growth regulators work best when applied to plants during a specific stage of plant growth. Applying the chemical before or after the proper stage reduces or even eliminates its effectiveness.

Since growth regulators, desiccants, and defoliants are effective in small quantities, be careful to treat only target plants. Avoid accidental treatment of other plants due to drifts and residue in spray equipment and soil.

Self-Help Questions on Section 7 – Pests

Now that you have studied Section 7, answer the following questions. Write the answers with pencil without referring back to the text. When you are satisfied with your written answers, see if they are correct by checking them with the text. * Erase your answer and write in the correct answer if your first answer is wrong. Note that these questions are not necessarily those that are used in the certification examination.

1. What parts of an insect are most important in classifying it?
2. If you cannot identify a pest, where should you go to seek help?
3. List the 13 major groups of insects of economic and/or medical importance.
4. How do spiders, mites and ticks differ from insects?
5. What are the two viewpoints of insect control?
6. What are some techniques for early detection of pests?
7. List 5 factors to consider in determining the economic importance of an insect.
8. Define a "weed".
9. List the 3 major life cycles of weeds and describe how they differ.
10. What is a "bulbous perennial"?
11. Define the following terms:
 - a. Selective herbicide
 - b. Translocated herbicide
 - c. Pre-emergence
12. What are the 4 main features of a plant disease?
13. List 5 nonparasitic disease agents.
14. Why do viruses cause serious problems in plants that are propagated by bulbs and roots?
15. What is a nematode?
16. List the 4 steps involved in the development of a plant disease.
17. List the main recognition features of the following classes of vertebrates and the kind of damage caused by each.

Animal	Recognition	Damage
Fish		
Reptiles		
Birds		
Mammals		
18. Define the following terms:
 - a. Plant growth regulator
 - b. Desiccant
 - c. Defoliant

*The questions are arranged in the order that they appear in the text.

SECTION 8: Pest Management



We often talk about the “war” against insects, or diseases, or weeds, or rats. In a war between countries, would a general use only the army against his enemy? Would he not also think about navy to blockade, the air force to destroy sources of munition, propaganda to reduce the enemy’s will to fight, etc? If he would consider nuclear weapons, he would also consider the consequences of dangerous fallout.

Yet, in our “war” against pests, how often do we use the handiest or cheapest pesticide without thinking of a better combination of methods or of consequences to the environment? Possibly, it is too often.

Pest management, or integrated pest management, is a modern philosophy of pest control that says we should employ all useful tactics to keep pests below economically harmful levels with a minimum harmful impact to the environment. Let us look at some examples.

EXAMPLES OF INTEGRATED PEST MANAGEMENT

Preventing Termites in a New House

Suppose a new house is to be built on a lot where termites are plentiful and potentially destructive. Do we treat the entire property with an insecticide to kill all termites and repeat the operation as often as needed? Alternatives are to treat only the house foundation area, keep wood out of contact with the ground, and use barriers to keep termites from getting into wooden members of the house. This is an obvious example of sound pest management.

Club Root of Cabbage

Cabbage and other cole crops have been grown for several years on a farm. The club root disease organism is so plentiful that cabbage production is no longer profitable. One solution would be to kill the pathogen with a suitable soil pesticide and repeat as often as required. Good pest management, on the other hand, would have prevented the buildup of the disease by using disease-free transplants and rotating the crop.

These are simple and rather obvious examples of pest management. Others could be cited on many different crops, including cotton, soybeans, citrus and apples. Some of these are complex, involving several control strategies.

Many of the tactics and principles of pest management have been known and used for many years. But the concept as such, the terms, and some of the methods are relatively new.

Our environment includes many kinds of plants and animals. These interact with one another and with the physical world of soil, water and air. In undisturbed “nature” there is a balance and considerable stability but this situation does not provide us with adequate food and fiber. To provide these, we have cut our forests, plowed our prairies, and planted crops. In so doing, we have favored certain plants and animals. But in so doing we have also provided abundant food and shelter for other plants and animals that are harmful to our crops and animals, or annoying to us. These other plants and animals — weeds, disease organisms, insects, rodents, and birds — we call pests.

Thus we see that when we change our environment, we change the interactions among plants and animals — sometimes in our favor and sometimes not. Our problem, then, is to make the environment less favorable for pests but still favorable for our crops. How can we do this?

The methods we use to reduce pest numbers we can call “tactics.” Some of these follow.

TACTICS OF PEST MANAGEMENT

Resistant Varieties

Crops and animals vary widely in their resistance to pests. By using resistant types, we make the environment less favorable for pests and easier for us to keep them below harmful levels. Examples: resistant strains of St. Augustine grass being developed to combat St. Augustine Decline (SAD); crabapple vari-

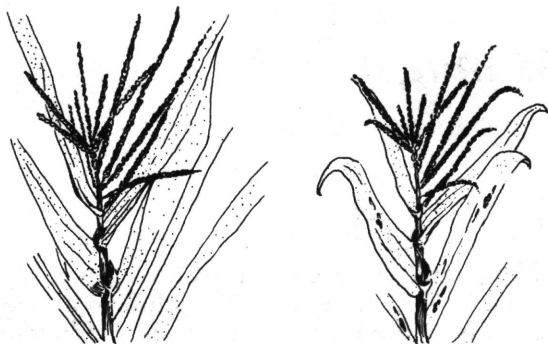

eties with resistance to fire blight; strawberry varieties resistant to leaf spot and verticillium wilt; alfalfa varieties resistant to alfalfa weevil; varieties of Brussels sprouts resistant to cabbage aphid; and varieties of Scots pine resistant to pine grosbeak.

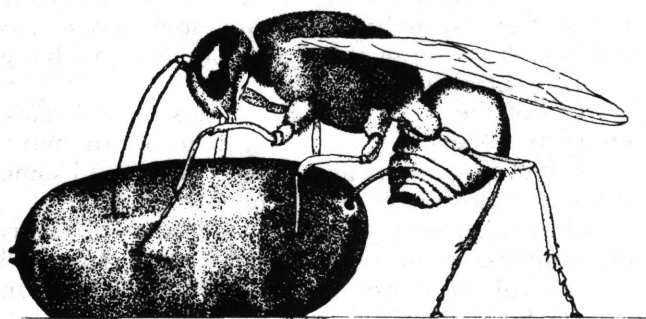

Biological Control

Many of our pests are introduced from other countries. Finding and introducing their natural parasites, predators, and disease organisms will often control or help to reduce such pests. Biological control is most common for insects, mites and some weeds. Examples: hymenopterous parasites of alfalfa weevil; ladybird beetles to suppress scale insects; a seed fly to help combat tansy ragwort; and *Bacillus thuringiensis* (BT or Dipel), a bacterium, to control various insect pests on vegetables and ornamentals.

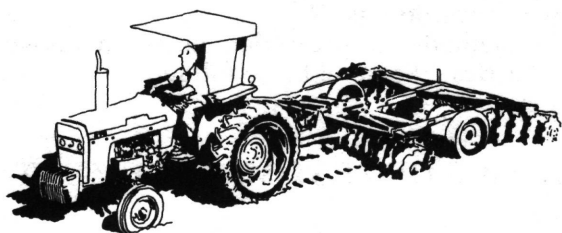

Cultural Control

Planting, growing, harvesting, and tillage practices may be favorable or unfavorable to pests. Plowing and cultivating, for example, are harmful to some weeds, insects, and disease organisms. But the same prac-

tices may help to spread other weeds and disease organisms and nematodes. Other cultural processes such as fertilization, crop rotation, and time of planting all influence pests. Using cultural processes that reduce pest numbers and avoiding those that favor pests will help protect crops. On some crops, this may be the only control you need. Examples of cultural control: changing watering and ventilation patterns to prevent moss and algae from growing in greenhouses; frequent watering and fertilizing of birch trees to help them withstand bronze birch borer attack; late planting of wheat to avoid Hessian fly infestation; early cutting of alfalfa to eliminate the need for a spray for alfalfa weevil; using a roto-tiller to kill weeds between the rows of a vegetable garden.

Sanitation

Removing food, water, or shelter for the pest or making the site inaccessible is very important in the control of some pests. In fact, for some pests, effective control cannot be maintained without good sanitation practices. Examples of sanitation: removal of food, garbage, or filth to prevent roaches, rats, and flies; removal and burning of tent caterpillar nests; pruning out fruit tree limbs infested with black knot.

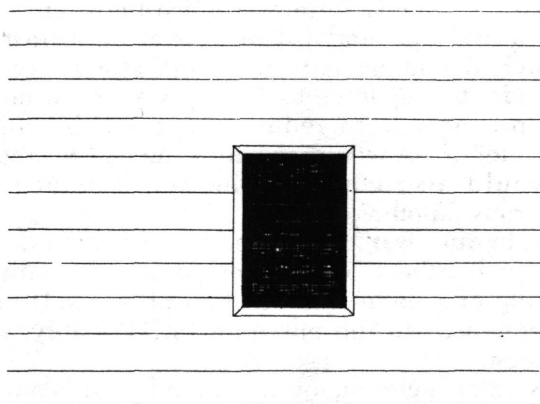

Mechanical-Physical Control

The use of traps, barriers, light, sound, heat, cold, nuclear radiation and electrocution are some physical methods. These have very limited potential for crop insect control, but are often very effective for other sites. Examples: screens to exclude mosquitoes; rodent-proofing barriers; termite exclusion barriers; sticky bands around tree trunks to trap various insects which crawl up the trees; flypaper; mousetraps. Some of these, such as sticky traps and black light traps, may have more usefulness as methods of detecting the beginning of an infestation.

Legal Control

Quarantines, inspections, embargoes, compulsory crop or product destruction, and similar actions taken under the provisions of federal, state, or local laws and



regulations are legal control measures. Examples: mandatory destruction of abandoned cherry orchards; mandatory treatment of Christmas trees being shipped out of Michigan to control cereal leaf beetle; the gypsy moth control program; inspection of nursery stock for clover root curculio.

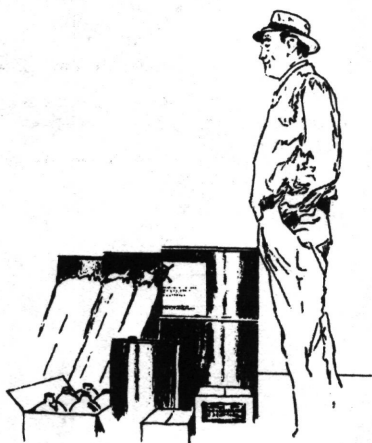

Chemical Control (Pesticides)

Chemicals may be used to kill, repel, attract, sterilize, or otherwise interfere with the normal behavior of pests. Pesticides must be used in many situations where other tactics cannot prevent harmful pest levels. Limited use is made of sterilants, repel-

lents, and attractants at present. Examples of chemical control: pentachlorophenol to protect telephone poles from wood-damaging pests; mothballs to repel clothes moths; sex pheromone of the gypsy moth to reduce mating incidence; 2, 4-D to kill weeds; captan to control diseases; malathion to kill insects.

Integrated Control

This is the use of a combination of two or more practices that fit into an effective program of pest reduction. An integrated program may involve the selection of planting and harvest dates, resistant varieties, use of pest-specific pesticides, and the encouragement or distribution of biological control agents. It usually includes elements of pest management so that pesticides are applied only when economic threshold numbers of pests are observed.

An example will help to show this. The cotton boll weevil is so serious that it must be controlled by pesticides to produce a profitable crop. But insecticides applied during the regular season also kill parasites and predators that normally control cotton boll worm, white flies, and other potential pests. The integrated pest management system for cotton helps avoid this problem:

- destroying cotton stubble in the fall soon after harvest to reduce the weevil food supply,
- killing weevils before they hibernate by applying insecticides in the late summer and fall when they do not interfere with biological control of other pests, and
- planting trap crops in the spring and treating them with insecticides.

This integrated system operated along with careful monitoring for outbreaks of pests provides satisfactory pest control with a minimum of pesticides.

A new way to predict if and when pests will reach economically damaging levels (economic thresholds) is being developed. It uses monitoring, sampling and computer analysis.

You should know about pest management programs in progress in your area so you can work with them to provide the best possible pest protection.

Self-Help Questions on Section 8 – Pest Management

Now that you have studied Section 8, answer the following questions. Write the answer with pencil without referring back to the text. When you are satisfied with your written answers, see if they are correct by checking them with the text. Erase your answer and write in the correct answer if your first answer is wrong. Note that these questions are not necessarily those that are used in the certification examination.*

- 1. Define integrated pest management.*

- 2. How do resistant varieties protect against pests?*

- 3. Give 4 examples of cultural practices that may affect pests.*

- 4. A mousetrap is an example of what kind of control?*

- 5. Are chemicals used only to kill pests?*

- 6. In an integrated control program, when are pesticides used?*

**The questions are arranged in the order that they appear in the text.*

Glossary

Definitions included serve as a reference for using the terms as they pertain to pesticides.

Abscission: The formation of a layer of cells which result in fruit, leaf or stem drop from a plant.

Absorption: The uptake of substances by the skin, respiratory tract and gastrointestinal tract; also refers to the uptake of substances by plant parts or organs.

Acaricide: A pesticide used to control mites and ticks. Same as miticide.

Acid equivalent: The theoretical yield of parent acid from an ester or salt such as esters of 2, 4-D or the amine salt of 2, 4-D.

Activator: A material added to a pesticide to increase, either directly or indirectly, its toxicity.

Active Ingredient: The chemical or chemicals in a product responsible for the desired effects, which are capable, in themselves, of preventing, destroying, repelling or mitigating insects, fungi, rodents, weeds or other pests.

Acute Toxicity: Ability to cause injury or death from a single or limited exposure.

Adherence: The property of a substance to adhere or stick to a given surface.

Adjuvant: Any component of a formulation which modifies the mixture beneficially.

Adsorption: The process by which materials are held or bound to the surface in such a manner that the chemical is only slowly available. Clay and high organic soils tend to adsorb pesticides in many instances.

Adulterated: By law, applies to any pesticide if its strength or purity falls below the professed standard of quality as expressed on its labeling or under which it is sold or if any substance has been substituted wholly or in part for the article or if any valuable constituent of the article has been wholly or in part abstracted. May also apply to illegal residues in food.

Aerobic: Living or functioning in air or free oxygen. The opposite of *anaerobic*.

Aerosol: An extremely fine mist produced when the pesticide dissolved in a liquid gas is released into the air from pressurized container.

Alkaloid: Naturally occurring nitrogenous materials appearing in some plants which are used in preparing the botanically-derived insecticides.

Amphibians: A class of animals of the subphylum Vertebrata. They are intermediate between fish and reptiles. They are cold-blooded with nucleated red blood cells and have a moist skin without scales, feathers or hair.

Anaerobic: Living or functioning in the absence of air or free oxygen. The opposite of *aerobic*.

Animal Sign: The evidences, distinctive for a particular species, that are left indicating an animal's presence in an area.

Anionic Surfactant: A surface-active additive to a pesticide having a negative surface charge. The anionics perform better in cold, soft water. Most wetting agents are of this class.

Annual: A plant that completes its life cycle from seed to seed in one year.

Antagonism: The phenomenon which results in a depression of activity of organisms or compounds when two or more occur in close proximity.

Antibiotic: Substance usually produced by a microorganism which is injurious to other microorganisms (streptomycin, cycloheximide, etc.).

Anticoagulant: A substance which prevents normal blood clotting.

Antidote: A practical treatment, including first aid, used in treatment of poisoning.

Aquatic Weeds: Undesirable plants that grow in water.

Aqueous: Indicating the presence of water in a solution. A solution of a chemical in water.

Arsenicals: Inorganic pesticides containing arsenic.

Aseptic: Free of disease-causing organisms.

Attractants: Substances or devices capable of attracting insects or other pests to areas where they can be trapped or killed.

Avicide: Any chemical used to kill birds.

Bactericide: Any chemical used to kill bacteria.

Bait Shyness: The tendency for rodents, birds or other pests to avoid a poisoned bait.

Band Application: An application to a continuous restricted area such as in or along a crop row rather than over the entire field area.

Basal Treatment: A treatment applied to the stems or trunks of plants at and just above the ground line.

Biennial: A plant that completes its life cycle in two years. The first year it produces leaves and stores food. The second year it produces fruits and seeds.

Biocide: A chemical which has a wide range of toxic properties, usually to members of both the plant and animal kingdoms.

Biological Control: Control of pests by means of predators, parasites and disease-producing organisms.

Birds: A class of animals of the subphylum Vertebrata that differ from their ancestral reptiles by having a covering of feathers. They have a warm-blooded metabolism and the forelimbs are modified into wings.

Botanical Pesticide: A pesticide produced by and extracted from plants. Examples are nicotine, pyrethrum, strychnine and rotenone.

Brand: The name, number, trademark or designation of a pesticide or device made by the manufacturer, distributor, importer or vendor. Each pesticide differing in the ingredient statement, analysis, manufacturer or distributor, name, number or trademark is considered as a distinct and separate brand.

Broadcast Application: An application over an entire area.

- Broadleaf Species:** Botanically — those plants classified as dicotyledons; morphologically — those having broad, rounded or flattened leaves as opposed to the narrow bladelike leaves of the grasses, sedges, rushes and onions.
- Brush Control:** Control of woody plants.
- Carcinogen:** A substance or agent capable of producing cancer.
- Carcinogenic:** The term used to describe the cancer-producing property of a substance or agent.
- Carrier:** The liquid or solid material added to a chemical compound to prepare a proper formulation.
- Causal Organism:** The organism (pathogen) that produces a given disease.
- Centigrade (C):** A thermometer scale in which water freezes at 0 degrees and boils at 100 degrees. To change to degrees Fahrenheit, multiply centigrade by nine-fifths and add 32.
- Chemical Name:** One that indicates the chemical composition of the compound.
- Chemosterilant:** A chemical compound capable of causing reproductive sterilization.
- Chemotherapy:** The treatment of a desired plant or animal with chemicals to destroy or control a pathogen without seriously harming the plant.
- Chlorinated Hydrocarbon:** A chemical compound containing chlorine, carbon and hydrogen. DDT is a chlorinated hydrocarbon.
- Chlorosis:** The yellowing of a plant's normally green tissue because of a partial failure of the chlorophyll to develop.
- Cholinesterase:** A chemical catalyst (enzyme) found in animals that helps limit the activity of nerve impulses. Some pesticides — phosphates and carbamates, for example — can inhibit this enzyme and are called cholinesterase inhibitors.
- Chronic Toxicity:** Ability to cause injury or death from prolonged exposure.
- Common Pesticide Name:** A name given to a pesticide by a recognized committee. Many pesticides are known by a number of trade or brand names but have only one recognized common name. Example: the common name for Karathane, Arathane, Isocthane, and Mildex is dinocap.
- Compatible:** Two compounds are said to be compatible when they can be mixed without affecting each other's properties.
- Concentration:** Refers to the amount of active ingredient in a given volume or weight of diluent.
- Contact Herbicide:** A compound that kills primarily by contact with plant tissue rather than as a result of translocation. Only that portion of a plant contacted is directly affected.
- Contact Insecticide:** A compound that causes the death of an insect when it touches its external parts. It does not need to be ingested to be effective.
- Crucifers:** Plants belonging to the mustard family including mustard, cabbage, turnips, radish, etc.
- Cucurbits:** Plants belonging to the gourd family including pumpkins, cucumbers, squash, etc.
- Deciduous Plants:** Those plants that are perennial in habit but lose their leaves during the winter.
- Deflocculating Agent:** A material added to a suspension to prevent settling.
- Defoliant:** A compound which causes the leaves or foliage to drop from a plant.
- Degradation:** The process by which a chemical compound is reduced to a less complex compound.
- Dermal:** Of or pertaining to the skin.
- Dermal Toxicity:** Ability of a compound when absorbed through the skin of animals to produce symptoms of poisoning.
- Desiccant:** A compound that promotes drying or removal of moisture from plant tissues. (See *defoliant* for the difference between these two terms.)
- Diluent:** Any liquid or solid material used to dilute or carry an active ingredient.
- Dip Treatment:** The application of a liquid chemical to a plant or animal by momentarily immersing it, wholly or partially under the surface of the liquid, so as to coat the surface with the chemical.
- Directed Application:** An application to a restricted area such as a row, bed or at the base of plants.
- Dispersing Agent:** A material that reduces the cohesive attractive between like particles. Dispersing and suspending agents are added during the preparation of wettable powders to facilitate wetting and suspension of the active ingredient.
- Dormant:** State of inhibited growth of seeds or other plant organs due to internal causes.
- Dose, Dosage:** Quantity of a toxicant applied per unit of plant, soil or other surfaces.
- Drench Treatment:** The application of a liquid concentration to an area until the area is completely soaked.
- Emulsifiable Concentrate:** A formulation produced by dissolving the active ingredient and an emulsifying agent in a solvent. When added to water an emulsion (milky mixture) is formed.
- Emulsifying Agent:** A material which facilitates the suspending of one liquid in another.
- Emulsion:** A mixture in which one liquid is suspended as minute globules in another liquid; e.g., oil in water.
- Eradicant:** A chemical used to eliminate a pest from a plant or a place in the environment. (See also *chemotherapy*.)
- Fahrenheit (F):** A thermometer scale that marks the freezing point of water at 32 degrees and the boiling point at 212 degrees. See *centigrade (C)* also.
- Fish:** A class of animals of the subphylum Vertebrata that are cold-blooded and are restricted to a strictly aquatic environment and breathe by means of gills.
- Fog Treatment:** The application of a pesticide as a fine mist for the control of pests.
- Formulation:** The pesticide product containing the active ingredient, the carrier and other additives required to make it ready for sale.
- Fumigant:** A chemical that forms vapors (gases) and is used to destroy weeds, plant pathogens, insects or other pests.
- Fungi:** All nonchlorophyll-bearing thallophytes (singular: fungus). For example, rusts, smuts, mildews and molds.

- Fungicide:** A chemical that kills or inhibits fungi.
- Fungistatic:** A chemical that inhibits the germination of fungus spores or the development of mycelium while in continued contact with the fungus.
- Granule:** A type of formulation in which the active ingredient is mixed with, adsorbed, absorbed or pressed on an inert carrier forming a small pellet.
- GPM:** Gallons per minute.
- Growth Regulator:** A substance effective in minute amounts for modifying plant processes. (See Section 8 under Plant Growth Regulators for broader definition.)
- Growth Stages of Cereal Crops:** (1) Tillering — when additional shoots are developing from the lower buds. (2) Jointing — when stem internodes begin elongating rapidly. (3) Booting — when upper leaf sheath swells due to the growth of developing spike or panicle. (4) Heading — when seed head is emerging from the upper sheath.
- Hard (water):** Water containing soluble salts of calcium and magnesium and sometimes iron.
- Hazard:** The probability that injury will result from use of a substance in a proposed quantity and manner. The sum of the toxicity plus the exposure to a pesticide.
- Herbaceous Plant:** A vascular plant that does not develop woody tissue.
- Herbicide:** A pesticide used for killing or inhibiting plant growth. A weed or grass killer.
- Hydrogen-Ion Concentration:** A measure of the acidity. The hydrogen-ion concentration is expressed in terms of the pH of the solution. For example, a pH of 7 is neutral, from 1 to 7 is acid, and from 7 to 14 is alkaline.
- Impermeable:** Not capable of being penetrated. Semipermeable means permeable to some substances but not to others.
- Inert Ingredient:** Ingredients in a product which do not contribute to the activity of the active ingredient.
- In-Furrow Treatment:** The application of a chemical in a furrow.
- Ingredients:** The simplest constituents of the pesticide which can reasonably be determined and reported. Ingredients may be active or inert.
- Insect:** Any of the numerous small invertebrate animals generally having segmented bodies and for the most part belonging to the class Insecta, comprising six-legged, usually winged forms.
- Insecticide:** A substance or mixture of substances intended to prevent or destroy any insects which may be present in any environment.
- Label:** All written, printed or graphic matter on or attached to or accompanying the pesticide or the immediate container.
- Lactation:** The period during which an animal is producing milk.
- LC50:** The concentration of a compound which is expected to cause death in 50 percent of the test animals so treated. A means of expressing the toxicity of a compound present in air as dust, mist, gas or vapor. It is generally expressed as micrograms per liter as a dust or mist but in the case of a gas or vapor as parts per million.
- LD50:** By law, the dose which is expected to cause death within 14 days in 50 percent of the test animals so treated. If a compound has an LD50 of 10 mg/kg it is more toxic than one having an LD50 of 100 mg/kg.
- Low Volatile Ester:** An ester with a high molecular weight and a low vapor pressure capable of changing from a liquid to a gas.
- Mammals:** A class of animals of the subphylum Vertebrata which are warm-blooded and nourish the young with milk. The skin is more or less covered with hair.
- Metamorphosis:** Any change in form or structure of an insect during the growing period.
- Miscible Liquids:** Two or more liquids capable of being mixed and which will remain mixed under normal conditions.
- Molluscicide:** A chemical which kills slugs and snails.
- Mutagenic:** Capable of producing genetic change.
- Necrosis:** Localized death of living tissue, i.e., death of a certain area of a leaf or of a certain area of an organ.
- Necrotic:** A term used to describe tissues exhibiting varying degrees of dead areas or spots.
- Nematicide:** A material that will kill nematodes. (Nematicide is more acceptable than Nematocide.)
- Nonselective:** A chemical that is generally toxic to plants or animals without regard to species. A nonselective herbicide may kill or harm all plants.
- Noxious Weed:** A plant defined by law as being especially undesirable, troublesome and difficult to control.
- Oral Toxicity:** Ability to cause injury when taken by mouth.
- Organic Compounds:** A large group of chemical compounds that contain carbon. See also organochlorine and organophosphate.
- Organochlorine:** Same as chlorinated hydrocarbon.
- Organophosphate:** An organic compound containing phosphorus; parathion and malathion are two examples.
- Ovicide:** A substance that destroys eggs.
- Pathogen:** Any disease-producing organism or virus.
- Perennial:** A plant that lives for more than two years.
- Pest:** Forms of plant and animal life or viruses that exist under circumstances that make them injurious to plants, man, domestic animals or other animals, articles or substances.
- Pesticide:** A chemical substance used to kill pests. The pests may be weeds, insects, rats and mice, algae, nematodes and other destructive forms of life.
- Phytotoxic:** Injurious to plants.
- Plant Growth Regulators:** A substance that alters the growth of plants. The term does not include substances intended solely for use as plant nutrients or fertilizers.
- Postemergence:** After the appearance of a specified weed or crop.
- PPB:** Parts per billion. A way of expressing amounts of chemicals in foods, plants, animals, etc. One part per billion equals 1 lb. in 500,000 tons.
- PPM:** Parts per million. A way of expressing amounts of chemicals in foods, plants, animals, etc. One part per million equals 1 lb. in 500 tons.

- Predator:** An animal that preys on, destroys or devours other animals. Even though most animals prey on smaller forms, this term is usually restricted to members of the order Carnivora (dog, cat, weasel, etc. families) plus a few meat-eaters from other mammalian groups, such as opossums and seals. Raptorial birds, i.e., hawks, owls and eagles are included, sometimes with fish-eaters like herons and kingfishers. Some fish and reptiles may also be included.
- Preemergence:** Prior to emergence of the specified weed or crop.
- Preplant:** Application of a pesticide prior to planting a crop.
- Propellant:** Agent in self-pressurized pesticide products that produces the force required to dispense the active ingredient from the container.
- Protectant:** A chemical applied to the plant or animal surface in advance of the pest (or pathogen) to prevent infection or injury by the pest.
- PSI:** Pounds per square inch.
- Pubescent:** Hairy. It affects ease of wetting of foliage; also retention of spray on foliage.
- Repellent:** A compound that is annoying to a certain animal or other organism, causing it to avoid the area in which it is placed.
- Reptiles:** A class of animals of the subphylum Vertebrata that are air-breathing and cold-blooded. They lack hair or feathers on the skin, which is more or less covered with horny epidermal plates or scales.
- Residue:** The amount of chemical that remains on the harvested crop.
- Rhizome:** Underground rootlike stem that produces roots and leafy shoots. Examples: The white underground parts of Johnson grass and horse nettle; the black parts of Russian knapweed.
- Rodent:** All animals of the order Rodentia, such as rats, mice, gophers, woodchucks or squirrels.
- Rodenticide:** A substance or mixture of substances intended to prevent, destroy, repel or mitigate rodents.
- RPM:** Revolutions per minute.
- Safener:** A material added to a pesticide to eliminate or reduce phytotoxic effects to certain species.
- Seed Protectant:** A chemical applied to seed before planting to prevent disease and insect attack on seeds and new seedlings.
- Selective Pesticide:** A chemical that is more toxic to some species (plant, insect, animal, microorganisms) than to others.
- Slurry:** A thick suspension of slightly soluble to insoluble pesticides in a liquid medium (usually water being the main liquid). Particles will settle out of a slurry fairly rapidly upon standing if not kept under agitation. See *suspension*.
- Soil Application:** Application of a chemical to the soil rather than to vegetation.
- Soil Incorporation:** Mechanical mixing of the pesticide with the soil.
- Soil Injection:** Mechanical placement of the pesticide beneath the soil surface with a minimum of mixing or stirring. Common method of applying liquids that change into gases.
- Soil Sterilant:** A chemical that prevents the growth of plants, microorganisms, etc., when present in soil. Soil sterilization may be temporary or relatively permanent, depending on the nature of the chemical being applied.
- Solution:** Mixture of one or more substances in another in which all the ingredients are truly and completely dissolved in the molecular state.
- Solvent:** A liquid which will dissolve a substance forming a true solution (liquid in molecular dispersion).
- Spot Treatment:** The application of a pesticide to selected individual plants, animals or soil.
- Spray Drift:** The movement of airborne spray particles away from the intended application area.
- Spreader:** A substance which increases the area that a given volume of liquid will cover on a solid or on another liquid.
- Sticker:** A material added to a pesticide to increase its persistence or adherence rather than to increase initial deposit.
- Stolon:** Above ground runners or slender stems that develop roots, shoots and new plants at the tip of nodes as in the strawberry plant or Bermuda grass.
- Stomach Poison:** A pesticide that must be eaten by an insect or other animal in order to kill the animal.
- Supplement:** Same as adjuvant. Substance added to a pesticide to improve its physical or chemical properties. May be a sticker, spreader, wetting agent, safener, etc., but usually not a diluent.
- Surfactant:** A material which increases the emulsifying, dispersing, spreading, wetting or other surface-mollifying properties of a pesticide formulation.
- Susceptible Species:** A plant or animal that is affected by moderate amounts of a pesticide.
- Suspension:** A system consisting of very finely divided solid particles dispersed in a liquid.
- Synergism:** The joint action of two or more pesticides that is greater than the sum of the pesticides when used alone.
- Systemic Pesticide:** A chemical which is translocated within the plant. For example, a systemic insecticide can be applied to the soil, enter the roots of the plant, travel to the leaves and kill insects feeding on the leaves.
- Tolerance:** (1) By law, a regulation that establishes the maximum amount of a pesticide chemical that may remain on a raw agricultural commodity. (2) The ability of a living organism to withstand to a degree a disease, insect attack, dry weather, etc.
- Toxicant:** Any poison or poisonous substance. The active ingredient, for example, in a herbicide or insecticide, is the toxicant. However, the active ingredient in a plant growth regulator may not poison the plant and, therefore, is not a toxicant. All active ingredient compounds are not toxicants.
- Toxicity:** The natural capacity of a substance to produce injury. Toxicity is measured by oral, dermal and inhalation on test animals.
- Trade Name:** Same as brand name.
- Translocated Pesticide:** One that is moved within the plant from the site of entry. Systemic pesticides are translocated.

ULV: Ultra low volume; no water applied with the pesticide formulation.

Vapor Drift: The movement of vapors of a volatile chemical from the area of application.

Vapor Pressure: The property which causes a chemical compound to evaporate. The lower the vapor pressure, the more volatile the compound.

Vector: A carrier such as an insect that carries and transmits a pathogen. Example: Some virus diseases of plants can only be carried by certain insects.

Vertebrate Animals: A major category of animals that are distinctive by their possession of a segmented spinal column.

Viscosity: A property of liquids that resists flow. Viscosity of liquids usually increases with a decrease in temperature.

Volatile: A compound is said to be volatile when it evaporates (changes from a liquid to a gas) at ordinary temperatures on exposure to air.

Weed: A plant that is undesirable due to certain characteristics or its presence in certain areas. A plant growing in a place where it is not wanted.

Wettable Powder: A coil (powder) formulation which, on addition to water, forms a suspension used for spraying. It is prepared by adding water-soluble agents to the formulation.

Wetting Agent: A compound that reduces surface tension and causes a liquid to contact plant surfaces more thoroughly.

Winter Annual: Plants which germinate in the fall and complete their life cycle by early summer.

Zero Tolerance: By law, no detectable amount of the pesticide may remain on the raw agricultural commodity when it is offered for shipment. Zero tolerances are no longer allowed.

Other Terms Used in Pest Control

Some of these words have several meanings. Those given here are the ones that relate to pest control.

- Abrasion:** The process of wearing away by rubbing.
- Abscission:** The separation of fruit, leaves or stems from a plant.
- Absorption:** The process by which a chemical is taken into plants, animals or minerals. Compare with adsorption.
- Activator:** A chemical added to a pesticide to increase its activity.
- Adherence:** Sticking to a surface.
- Adjuvant:** Inert ingredient added to a pesticide formulation to make it work better.
- Adsorption:** The process by which chemicals are held on the surface of a mineral or soil particle. Compare with absorption.
- Adulterated:** Any pesticide whose strength or purity falls below the quality stated on its label. Also, a food, feed or product that contains illegal pesticide residues.
- Aerobic:** Living in air. The opposite of anaerobic.
- Aerosol:** An extremely fine mist of fog consisting of solid or liquid particles suspended in air. Also, certain formulations used to produce a fine mist.
- Agitation:** The process of stirring or mixing in a sprayer.
- Alkaloids:** Chemicals present in some plants. Some are used as pesticides.
- Anaerobic:** Living in the absence of air. The opposite of aerobic.
- Animal sign:** The evidence of an animal's presence in an area.
- Antagonism:** The loss of activity of a chemical when exposed to another chemical.
- Antibiotic:** A substance which is used to control pest microorganisms.
- Antidote:** A practical treatment for poisoning, including first aid.
- Aqueous:** A term used to indicate the presence of water in a solution.
- Arsenicals:** Pesticides containing arsenic.
- Aseptic:** Free of disease-causing organisms.
- Bait shyness:** The tendency for rodents, birds or other pests to avoid a poisoned bait.
- Bipyridyliums:** A group of synthetic organic pesticides which includes the herbicide paraquat.
- Botanical pesticide:** A pesticide made from plants. Also called a plant-derived pesticide.
- Broadleaf weeds:** Plants with broad, rounded, or flattened leaves.
- Brush control:** Control of woody plants.
- Carbamate:** A synthetic organic pesticide containing carbon, hydrogen, nitrogen and sulfur.
- Carcinogenic:** Can cause cancer.
- Carrier:** The inert liquid or solid material added to an active ingredient to prepare a pesticide formulation.
- Causal organism:** The organism (pathogen) that produces a specific disease.
- Chemosterilant:** A chemical that can prevent reproduction.
- Chlorinated hydrocarbon:** A synthetic organic pesticide that contains chlorine, carbon, and hydrogen. Same as organochlorine.
- Chlorosis:** The yellowing of a plant's green tissue.
- Cholinesterase:** A chemical catalyst (enzyme) found in animals that helps regulate the activity of nerve impulses.
- Compatible:** When two or more chemicals can be mixed without affecting each other's properties, they are said to be compatible.
- Concentration:** The amount of active ingredient in a given volume or weight of formulation.
- Contaminate:** To make impure or to pollute.
- Corrosion:** The process of wearing away by chemical means.
- Crucifers:** Plants belonging to the mustard family, such as mustard, cabbage, turnip and radish.
- Cucurbits:** Plants belonging to the gourd family, such as pumpkin, cucumber and squash.
- Deciduous plants:** Perennial plants that lose their leaves during the winter.
- Deflocculating agent:** A material added to a suspension to prevent settling.
- Degradation:** The process by which a chemical is reduced to a less complex form.
- Dermal:** Of the skin; through or by the skin.
- Dermal toxicity:** Ability of a chemical to cause injury when absorbed through the skin.
- Diluent:** Any liquid or solid material used to dilute or carry an active ingredient.
- Dilute:** To make thinner by adding water, another liquid or a solid.
- Dispersing agent:** A material that reduces the attraction between particles.
- Dormant:** State in which growth of seeds or other plant organs stops temporarily.
- Dose, dosage:** Quantity of a pesticide applied.
- Emulsifier:** A chemical which aids in suspending one liquid in another.
- Emulsion:** A mixture in which one liquid is suspended as tiny drops in another liquid, such as oil in water.
- Fungistat:** A chemical that keeps fungi from growing.
- GPA:** Gallons per acre.
- GPM:** Gallons per minute.
- Growth stages of cereal crops:** (1) tillering — when additional shoots are developing from the flower buds; (2) jointing — when stem internodes begin elongating rapidly; (3) booting — when upper leaf sheath swells due to the growth of developing spike or panicle; (4) heading — when seed head is emerging from the upper leaf sheath.
- Hard water:** Water containing soluble salts of calcium and magnesium and sometimes iron.
- Herbaceous plant:** A plant that does not develop woody tissue.
- Hydrogen-Ion concentration:** A measure of acidity or alkalinity, expressed in terms of the pH of the solution. For example, a pH of 7 is neutral, from 1 to 7 is acid, and from 7 to 14 is alkaline.
- Immune:** Not susceptible to a disease or poison.

Impermeable: Cannot be penetrated. Semipermeable means that some substances can pass through and others cannot.

Incompatible: When two or more chemicals in a mixture affect each other's properties, they are said to be incompatible.

Lactation: The production of milk by an animal, or the period during which an animal is producing milk.

LC₅₀: The concentration of an active ingredient in air which is expected to cause death in 50 percent of the test animals so treated. A means of expressing the toxicity of a compound present in air as dust, mist, gas or vapor. It is generally expressed as micrograms per liter as a dust or mist but in the case of a gas or vapor as parts per million (ppm).

LD₅₀: The dose of an active ingredient taken by mouth or absorbed by the skin which is expected to cause death in 50 percent of the test animals so treated. If a chemical has an LD₅₀ of 10 milligrams per kilogram (mg/kg) it is more toxic than one having an LD₅₀ of 100 mg/kg.

Leaching: Movement of a substance downward or out of the soil as the result of water movement.

Mammals: Warm-blooded animals that nourish their young with milk. Their skin is more or less covered with hair.

Miscible liquids: Two or more liquids that can be mixed and will remain mixed under normal conditions.

MPH: Miles per hour.

Mutagenic: Can produce genetic change.

Necrosis: Localized death of living tissue such as the death of a certain area of a leaf.

Necrotic: Showing varying degrees of dead areas or spots.

Nitrophenols: Synthetic organic pesticides containing carbon, hydrogen, nitrogen and oxygen.

Noxious weed: A plant defined as being especially undesirable or troublesome.

Oral: Of the mouth; through or by the mouth.

Oral toxicity: Ability of a pesticide to cause injury when taken by mouth.

Organic compounds: Chemicals that contain carbon.

Organochlorine: Same as chlorinated hydrocarbon.

Organophosphate: A synthetic organic pesticide containing carbon, hydrogen and phosphorus; parathion and malathion are two examples.

Ovicide: A chemical that destroys eggs.

Parasite (or parasitoid): An animal, usually smaller than its host, which feeds in or on another animal.

Pathogen: Any disease-producing organism.

Penetration: The act of entering or ability to enter.

Phytotoxic: Harmful to plants.

Pollutant: An agent or chemical that makes something impure or dirty.

PPB: Parts per billion. A way to express the concentration of chemicals in foods, plants, and animals. One part per billion equals 1 pound in 500,000 tons.

PPM: Parts per million. A way to express the concentration of chemicals in foods, plants, and animals. One part per million equals 1 pound in 500 tons.

Predator: An animal that destroys or eats other animals.

Propellant: Liquid in self-pressurized pesticide products that forces the active ingredient from the container.

PSI: Pounds per square inch.

Pubescent: Having hairy leaves or stems.

RPM: Revolutions per minute.

Safener: A chemical added to a pesticide to keep it from injuring plants.

Seed protectant: A chemical applied to seed before planting to protect seeds and new seedlings from disease and insects.

Soil sterilant: A chemical that prevents the growth of all plants and animals in the soil. Soil sterilization may be temporary or permanent, depending on the chemical.

Soluble: Will dissolve in a liquid.

Solution: Mixture of one or more substances in another in which all ingredients are completely dissolved.

Solvent: A liquid which will dissolve a substance to form a solution.

Spreader: A chemical which increases the area that a given volume of liquid will cover on a solid or on another liquid.

Sticker: A material added to a pesticide to increase its adherence.

Surfactant: A chemical which increases the emulsifying, dispersing, spreading and wetting properties of a pesticide product.

Susceptible: Capable of being diseased or poisoned; not immune.

Susceptible species: A plant or animal that is poisoned by moderate amounts of a pesticide.

Suspension: Finely divided solid particles mixed in a liquid.

Synergism: The joint action of two or more pesticides that is greater than the sum of their activity when used alone.

Tank mix: The addition of two or more separate pesticide formulations in the same container for application at the same time.

Target pest: The pest at which a particular pesticide or other control method is directed.

Tolerance: (1) The ability of a living thing to withstand adverse conditions such as pest attacks, weather extremes, or pesticides. (2) The amount of pesticide that may safely remain in or on raw farm products at time of sale.

Toxicant: A poisonous chemical.

Trade name: Same as brand name.

Vapor pressure: The property which causes a chemical to evaporate. The lower the vapor pressure, the more easily it will evaporate.

Vector: A carrier, such as an insect, that transmits a pathogen.

Viscosity: A property of liquids that determines whether they flow readily. Viscosity usually decreases when temperature decreases.

Volatile: Evaporates at ordinary temperatures when exposed to air.

Wetting agent: A chemical which causes a liquid to contact surface areas more thoroughly.

MICHIGAN STATE UNIVERSITY

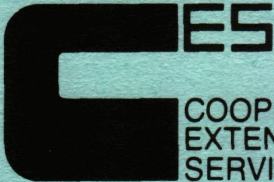

COOPERATIVE
EXTENSION
SERVICE

MSU is an Affirmative Action/Equal Opportunity Institution. Cooperative Extension Service programs are open to all without regard to race, color, national origin, sex, or handicap.

Issued in furtherance of cooperative extension work in agriculture and home economics, acts of May 8, and June 30, 1914, in cooperation with the U.S. Department of Agriculture. Gordon E. Guyer, Director, Cooperative Extension Service, Michigan State University, E. Lansing, MI 48824.

This information is for educational purposes only. Reference to commercial products or trade names does not imply endorsement by the Cooperative Extension Service or bias against those not mentioned. This bulletin becomes public property upon publication and may be reprinted verbatim as a separate or within another publication with credit to MSU. Reprinting cannot be used to endorse or advertise a commercial product or company.