

FILE COPY
DO NOT REMOVE

Managing Michigan

Ponds

For Sport Fishing

Second Edition



Acknowledgements

This bulletin was developed jointly by the Michigan Department of Natural Resources, the U.S. Department of Agriculture Soil Conservation Service, and the Michigan State University Cooperative Extension Service. Senior author John Schrouder was responsible for the parts dealing with fishery management: Chapters 5, 6, 7, 8, 9 and 12. Charles Smith wrote Chapters 3, 11 and 14. Patrick Ruzs did masters degree research at Michigan State University, resulting in the key find-

ing that pond depth of 15 feet or more is needed for maintaining satisfactory fish populations, and he worked on a preliminary draft of the bulletin. Ray White wrote Chapters 1, 2, 4, 10 and 13 and coordinated editing of the bulletin throughout.

William McClay of Michigan DNR was particularly helpful in reviewing the manuscript and suggesting alterations, as were Ned E. Fogle and David P. Borgeson, also of that Department. Glenn R. Dud-

derar, Extension Wildlife Specialist in the MSU Department of Fisheries and Wildlife, aided in developing Chapter 11.

The Pennsylvania State University Cooperative Extension Service at University Park provided the drawings of aquatic plants by Rae Chambers for Chapter 10. The Wisconsin Department of Natural Resources supplied drawings of fishes for Chapter 5. Other illustrations were by Michael Smith and Ray White.

Managing Michigan Ponds For Sport Fishing

Second Edition

by

John D. Schrouder

Fisheries Division, Michigan Department of Natural Resources

Charles M. Smith¹

Michigan Office, U.S. Department of Agriculture
Soil Conservation Service

Patrick J. Rusz²

Ray J. White³

Donald L. Garling*

Department of Fisheries and Wildlife, Michigan State University

¹Retired

²Michigan Wildlife Habitat Foundation, 6425 S. Pennsylvania, Lansing, MI 48911

³Dept. Fisheries and Wildlife, Montana State University, Bozeman, MT 59717

*Reviewed by

COPIES AVAILABLE FOR \$2.50 FROM:

MSU Bulletin Office
Cooperative Extension Service
10B Agriculture Hall
East Lansing, MI 48824-1039

Managing Michigan Ponds for Sport Fishing

Table of Contents

Chapter	Page
1. INTRODUCTION	1
The Resource	1
What Is Successful Management?	1
Caution! Are You Sure You Want a Pond?	2
Natural Ponds and Artificial Ponds	2
2. GENERAL CONSIDERATIONS	3
Goals	3
Investigation and Planning	4
Management Overview	4
Don't Plan on Financial Profit	4
Meeting State Environmental Regulations	5
3. BUILDING FISH PONDS	7
Pond Depth	7
Water Supply	9
Designing for Control of Aquatic Plants	9
Surface Area	10
Landscaping and Erosion Control in the Pond's Surroundings	10
Excavated or Dug Ponds	10
Impoundments	11
4. PONDS AS PLACES FOR FISH TO LIVE	13
Basic Pond Characteristics for Natural Production of Fish	13
The Pond Ecosystem	13
Consequences of Overenrichment	16
Facts About Water and Chemicals Dissolved in It	18
Pond Breathing, Circulation and Stratification	19
Investigating Pond Suitability for Fish	20
5. KINDS OF FISH TO USE IN PONDS	23
Coldwater Fishes	23
Rainbow Trout	24
Brook Trout	24
Brown Trout	24
Hybrid Trout	24
Warmwater Fishes	24
Largemouth Bass	24
Smallmouth Bass	25
Bluegill	25
Hybrid Sunfish	26
Channel Catfish	26
Forage Fishes	26
Fishes Not Recommended for Pond Management	27
6. HOW AND WHERE TO GET FISH FOR STOCKING	29
7. MANAGING WARMWATER PONDS FOR FISHING	31
Determining If a Pond Is Suitable for Warmwater Fish	31
Stocking	31
Angling Harvest	32

Higher Stocking Levels and Fish Feeding Not Recommended	34
Pond Fertilization and Liming	34
Emergency Aeration of the Pond	34
8. MANAGING COLDWATER PONDS FOR FISHING	35
General Considerations	35
Determining If a Pond Can Support Trout	35
Stocking	36
Preparing the Pond for Stocking	36
When to Stock	36
Number and Size of Trout to Stock	36
Transporting and Planting the Trout	37
When to Start Fishing and How Much to Harvest	37
Artificial Feeding	38
Special Aquatic Plant Control in Trout Ponds	38
Artificially Circulating the Pond Water	38
9. FISH POPULATION CONTROL	39
Intensive Angling	39
Predator Stocking	39
Spawning Bed Destruction	39
Cover Reduction	39
Water Level Drawdown	40
Seining	40
Live-Trapping	41
Fish Toxicants	42
10. AQUATIC PLANTS AND THEIR CONTROL	43
Kinds of Plants	43
How Nuisance Growths Occur	48
Vegetation Control by Restricting Phosphorus Supply	48
Materials from Surrounding Land	48
Pond Fertilization	49
Fish Food Application	49
Vegetation Control by Temporary Methods	49
Physical Disruption and Removal	50
Deepening the Pond to Control Vegetation	51
Waterlevel Drawdown	51
Selective Discharge	52
Pond Flushing and Dilution	52
Phosphorus Inactivation/Precipitation	52
Pond Aeration	52
Pondbed Sealing and Blanketing	52
Shading or Coloring the Water	52
Herbicides and Algicides	52
Biological Control	53
11. CONTROLLING ANIMAL NUISANCES	55
Muskrats and Woodchucks	55
Trapping Muskrats	55
Armoring the Shore	56
Repellents and Poisons	56
Moles	56
Birds	56
Turtles	56
Snakes	57
Swimmer's Itch	57
Mosquitoes	57
Leeches (Bloodsuckers)	57

12. FISH PARASITES AND DISEASES	59
13. MANAGING PONDS FOR PROFIT	61
14. POND SAFETY AND LIABILITY	63
15. STATE REGULATIONS ON POND BUILDING AND MANAGEMENT IN MICHIGAN	65
Pond Construction	65
Use of Chemicals to Control Pond Vegetation or Fish	65
Fish Stocking	66
Introducing Exotic Fish	66
Fishing Regulations	66
REFERENCES FOR FURTHER READING	67
APPENDICES	68
District Fisheries Offices of the Michigan Department of Natural Resources	68
Sources of Fish for Stocking	68
Consulting Biologists for Private Pond Investigation and Management	68
Fish Disease Diagnosis and Prescriptions for Control	68
Sources of Equipment and Supplies	69
Measurement Kits for Dissolved Oxygen, Alkalinity and pH	69
Water Thermometers	69
Nets, Netting and Seines	69
Aerators and Air-Lift Pond Circulators	69
Algicides and Aquatic Herbicides	69

Introduction

This bulletin is primarily for the present or prospective owner of a Michigan pond where the main goal is sport fishing—for the owner, his or her family, and a few friends. It should also be useful where the pond is for public fishing, or where the pond has some other primary use such as for waterfowl, swimming or irrigation, and angling is a side benefit.

The emphasis is on pond management under Michigan conditions, but much of the information should apply to other northern U.S. areas. Many other writings on pond fisheries pertain to conditions in states with milder climate and are unsuitable for Michigan.

Our objective is to help owners of existing ponds achieve more satisfactory fishing, as well as to aid aspiring owners in foreseeing pond potentials and problems before building or buying one. How a pond is situated and constructed strongly affects the success of management.

The Resource

Many Michigan land owners want ponds of their own for fishing, although they have free access to fishing in a greater offering of fresh waters than may exist in any other U.S. state: four Great Lakes fronting on some 3,200 miles of shoreline, 9,000 inland lakes, 36,000 miles (58,000 km) of streams, and numerous natural ponds. No person in Michigan is far from a selection of public fishing sites. But one's very own fishing water, close at hand on the farm or vacation property—or even in a suburban setting—may be more convenient, as well as privately controllable, although

not without costs and special responsibilities.

Between 25,000 and 40,000 artificial ponds have been built in Michigan. About 1,000 new ones are created each year. Most of these are primarily for fishing. Other purposes often include swimming, wildlife habitat, livestock watering, irrigation, and scenic enhancement. If a pond is especially designed and managed for one of these other purposes, it shouldn't be expected to provide the same quality of fishing as one designed especially as a fishery. For example, a pond that provides proper duck habitat may be too shallow and plant-choked to maintain enough oxygen for fish during hard winters.

What qualifies as a pond, and how does it differ from a lake? There are no sharp differences. Everyone thinks of a pond as being smaller than a lake, but opinions vary as to how much smaller. This bulletin is intended to deal primarily with water bodies ranging in size from $\frac{1}{4}$ acre to 10 acres (0.2 to 4 hectares).

Regardless of size, ponds typically provide a few years of good fishing when new, or when "renovated" in various ways, then fishing deteriorates as fish populations change. On occasion, ponds may be dismal failures right from the start, usually because of faulty design, improper location, or poor water quality.

What is Successful Management?

When is a pond a "success" or "failure?" **Satisfaction** is the key. The owner's or user's idea of what



constitutes angling quality and satisfaction is the ultimate measure of a pond's success. Much of this bulletin is written to help the many pond owners and users who aren't satisfied with their fishing. But if the fishing in your own pond does satisfy you, enjoy it, and don't pay too much attention to what others say is a more successful kind of pond.

Because satisfactory fishing is so much a matter of personal taste (some people are disappointed at anything less than trophy-sized bass or trout, while others are delighted with catching stunted bluegills or bullheads), we try not to tell owners and users what **the** right kind of pond or pond management is. Instead, we explain principles and describe alternatives from which to choose.

Caution! Are You Sure You Want a Pond?

Creating and managing a pond can require substantial time, effort

and money. There is risk of waste or property damage. Matters of legal liability, such as injuries and drownings are of concern. Another problem is overabundance of aquatic weeds. Trying to prevent or control them can be frustrating, although we'll provide information to ease the job.

Many owners soon discover that having a fishing pond is a bit like having a pet or an automobile. It needs to be well cared for if it is to serve its purpose. Trying to maintain a prime fishing pond is like striving to keep a hunting dog or racing car in good shape. Performance depends on great attention to details. Do you really have time for that?

Natural Ponds and Artificial Ponds

Many naturally-formed ponds exist in the Michigan landscape. They typically have marshy, gradually-sloping edges. Many of them have only a few feet of water at the

deepest point, not enough to maintain good fishing, but fine for wildlife. Natural marshy or swampy ponds can be highly enjoyable just for the sights and sounds, possibly also for the hunting they offer. If such a pond provides some fishing, it's a bonus. If a natural pond is deep enough (about 15 feet or more) to furnish proper habitat for a flourishing fishery, then the owner is fortunate indeed.

This bulletin should help in realizing added fishing from natural ponds, whether they are of low or high potential. However, owners are cautioned that radical management, especially in the form of reshaping the basin or altering plant life to benefit fish, may destroy some wildlife habitat or damage other features which the owner values.

The artificial pond, designed for maximal fish abundance and minimal maintenance, is quite different from most natural ponds. It has steeply-sloping sides and depth greater than 15 feet, no matter what the surface area.

General Considerations

There's more to satisfactory pond fishing than just putting in some fish. Ponds, like gardens, need proper design and management if a substantial crop is to be harvested. Just as in gardening, many questions must be answered before management can be done well. Some of the important questions are:

- What is my goal in having the pond? Fishing? Swimming? Wildlife? Irrigation? Livestock watering? Nature study? Scenery?
- If there are several goals, which is the main one, and how do the others rank in priority?
- What, roughly, is the pond's potential for producing fish in terms of space, water fertility, and other aspects of pond quality?
- What water depth should I build (or rebuild) for?
- What kind(s) of fish should I stock? What sizes? How many? When?
- When can I start fishing the pond?
- How many fish should be harvested each year and at what sizes?
- How can I prevent or remedy overpopulation of fish and stunted growth?
- How can I prevent or control nuisance growths of aquatic weeds and algae?
- Am I willing and able to spend the time and effort needed to achieve the results I desire?

This bulletin provides information to help the owner or manager develop answers that apply to his or her particular pond.

Goals

Lack of a clear goal is often at the root of unsatisfactory pond construction and management. Frequent switching between several goals is also a problem. It is best to decide on and work toward a single primary goal based on careful assessment of pond potential. It's a good idea to write the goal down and keep it in view. Stick to the goal for enough years to see whether it works.

Satisfactory fishing is undoubtedly the primary goal, or at least a secondary one, for people reading this bulletin. We urge you to write the goal down in terms of the kinds of fish desired and also to list what the lesser goals are.

Don't be misled by the "multiple-use" concept. Trying to accomplish too many things with the pond can mean that none works out well. Don't expect swarms of large fish in a clearwater situation with flocks of ducks and geese, a livestock watering area, and large amounts of irrigation water to be provided by the same pond. With effort, you'll be lucky to achieve one major benefit and a few pleasant side effects. For example, a soundly managed bass or trout pond might also offer a little swimming and skating, as well as an emergency water supply and be a scenic asset frequented by songbirds and visited occasionally by migrating ducks.

A reasonable goal for a pond fishery in our region is a moderate amount of angling for small to medium-sized fish. Some angling fun and a meal of fish now and then are reasonable expectations. Michigan ponds can't produce as many



large, fast-growing fish as do the warmer ponds in southern states.

Investigation and Planning

Undertake pond construction and management only after thorough study of the situation. After reading about ponds, examine the pond (or potential pond sites) in as much detail as possible. Several sections of this bulletin suggest characteristics of the pond and its fish population that can be measured and analysed. Consider hiring a professional fishery biologist to analyse the pond and devise a management plan.

Pond design and construction are highly important to the success of the fishery. If you intend to build a pond, see the section on that subject in this bulletin and contact the U.S. Soil Conservation Service office in your county about engineering design services.

Management Overview

After planning carefully, act with moderation. Overmanagement and applying management techniques simply because the manager knows how to do them (or is fascinated by the activity) are common mistakes that may detract from efficiency and success in achieving a desirable fishery. Knowing when to leave things alone is important.

The usual steps in managing a Michigan pond for fishing are:

1. Build or rebuild for best depth and slopes (Chapter 3).
2. Eradicate all fish in the pond (Chapter 9).
3. Stock suitable fish (Chapters 5, 6, 7, and 8).

If it is a trout pond, restocking will generally be done each year. If it is a warmwater pond, the fish (unless hybrids) will almost always reproduce, and no further stocking should be done—except when panfish are used, whereupon overpopulation and stunting usually occur, and the population must be “renovated” by eradication and restocking.

The interrelated ideas of **balance** between predator and food organ-

isms and of the **happy medium** or having the right amounts (rather than too much or little) of certain things in the pond are important to management for sustained quality of fishing. To maintain the pond as a good place for fish to live, water fertility, other chemical characteristics, and temperature must stay within certain limits—and there will be a happy medium for each pond condition where fish will best thrive.

There can be too little water fertility, a range of fertility in which the pond life functions well, or too much fertility. With too little fertility, not enough plant and animal life will grow to feed many fish. With excessive fertility (all too often the case in Michigan), plants clog the pond, organic matter accumulates in great amount, and the pond becomes unstable for fish because organic rotting from time to time reduces dissolved oxygen to insufficient levels. Too much artificial feeding results in the same problem.

Growing fish in a pond is much like growing cattle on a pasture. Both fish and cattle grow well and yield much meat as long as there are enough breeding stock, and the food supply isn't overgrazed. Too many fish or cattle ruin the food supply. Undernourishment and poor growth follow.

For example, if you stock two small, identical ponds with unequal numbers of fish, 1,000 in one and 10,000 in the other, each pond will have about the same total weight of fish a year later. But the fish in the pond stocked with 1,000 will be larger than those in the pond stocked with 10,000. **Don't overstock**, and don't let the fish become too numerous!

In ponds managed as trout or bass fisheries, angling harvest must be carefully restricted if fish are to live long enough to reach large size. On the other hand, where panfish are present, severe cropping of small-sized fish is needed if overpopulation is to be avoided. Keeping panfish populations in check by angling alone is rarely if ever successful in Michigan, however.

For best bass fishing, panfish should be excluded from Michigan ponds. This contrasts with manage-

ment in more southerly states. There, apparently due to warmer water and longer growing seasons, bass prey more heavily on panfish, control their abundance, and maintain a productive predator-prey balance. Bass in Michigan ponds usually don't eat enough bluegills or other panfish to maintain such a balance because bass are overfished. The result of having panfish in a Michigan pond, with or without bass, is a panfish overpopulation and consequent stunted growth of all kinds of fish in the pond. Predation by bass, however, may stave off the panfish overcrowding if bass over 15 inches are protected. Adequate numbers of large bass might need to be present to exert effective control.

Despite the disadvantages of panfish in our climate, they need not be completely disregarded. Various options for their management in Midwestern ponds exist. The pond can be treated with toxicants to eradicate all fish after panfish overpopulation and poor growth have developed and then restocked, but with loss of a year's fishing each time this is done. Sterile hybrid panfish can be used instead of ones that reproduce, but these are expensive, hard to obtain, and there are almost always fertile “mistakes” among the hybrids, which means that eventually a breeding population develops. Another alternative is simply to accept and enjoy fishing for stunted panfish. Such fishing is ideal for small children who like to catch lots of little fish.

Don't Plan on Financial Profit

Some pond owners envision financial profit, either by raising fish to sell or by charging anglers a fee to fish. Both “fish farming” and “fee fishing” are risky ventures in this state, and few such enterprises are successful. Special managerial skills and large investments in facilities are required for success. Michigan trout producers can't compete well in the markets with operators in western states that have larger supplies of water which is the right temperature year round. Warm-

water ponds in Michigan aren't warm enough long enough to raise catfish as well as they can be raised in the South. Down there, catfish grow from fingerling to marketable size in one summer. In Michigan it takes three years and, therefore, isn't profitable.

Meeting State Environmental Regulations

The construction and management of ponds can cause safety and

environmental problems. Therefore, state laws regulate the following matters relating to ponds:

- Damming and diking
- Excavation and dredging within 500 feet of any surface water
- Filling of wetlands and any land within 500 feet of surface water
- Discharge of fish food and wastes into streams or lakes
- Fish stocking
- Cutting of aquatic vegetation
- Use of chemicals as aquatic herbicides (algae or weed killers), fish toxicants, or fertilizers.

There are federal regulations on the use of chemicals to control plants and fish, as well. Before undertaking any of these activities, consult the nearest office of the Department of Natural Resources on how to proceed within the law.

Various permits may be needed. Proper application for a permit may not only spare future grief but result in tips from state officials on the best ways to accomplish your objectives.

Building Fish Ponds

Two general types of fish pond construction are used in Michigan:

Excavated or dug ponds. These are the most common type in Michigan. They are usually rather small ponds in fairly level terrain, made by digging a pit deeper than the groundwater table. The hole then fills with groundwater by seepage, or water flows in from nearby springs. Less commonly, pits are placed to catch runoff water from surrounding land or receive water diverted from a stream. These sources are less desirable than are groundwater springs and seepages.

Impoundments. Usually formed by earthen dams, impoundments are not recommended if construction requires damming a stream. Impoundments need greater land slope and tight soils. If created by damming a stream, they will be a settling basin for silt, sediment, and debris moving downstream and gradually fill in and become less suited for fish. There is also virtually no way to control immigration of undesirable fish from the stream making management all but impossible. If an impoundment is built, it is better for pond quality to impound water from springs rather than from runoff or streams. Damming streams of any size is strictly controlled in Michigan and requires a state permit.

Ponds can also be built by a combination of excavation and damming.

Proper site selection and careful planning of construction play large parts in successful fish pond management. Contact your county's office of the U.S. Soil Conservation Service (SCS) for help in choosing a site and designing the pond. Many mistakes have been made by failure to seek this advice.

When choosing a contractor to build the pond, compare the costs and services of several. Find out the contractor's previous performance by talking with others for whom the firm has built ponds.

A state permit is needed for construction of the pond if any of the following is true:

- It is to be formed by damming any running water.
- It is to be connected to any other running or standing water body.
- It is to be within 500 feet of any other water body.

Contact the nearest DNR office early in the planning stage to find out what restrictions may apply to your situation.

Key considerations in designing a successful fish pond are **water depth, water supply, and forming the basin and its surroundings to avoid overabundance of nutrients and aquatic plants.** Usually of somewhat lesser importance are the size of the pond's surface and landscaping details. All of these design considerations are interrelated, with one often greatly influencing one or more of the others.

Pond Depth

Pond depth is one of the most important factors for achieving satisfactory fishing. Whether the pond is formed by digging or impounding, and no matter how large its surface area, **a better fish population is likely to result from having water depth of 15 feet (5 meters) or more,** where soil conditions permit, throughout as much of the pond as possible. This helps avoid winter and summer



oxygen depletion and resultant stress on fish which can end in poor growth or mass die-off. Michigan ponds with less than 15 feet of water not only are more subject to complete winterkill in especially cold winters, but may, in most years, have disappointing fish populations—fewer fish, smaller fish, and less desirable kinds of fish—owing to near-winterkill conditions.

Lesser depth may suffice where strong flow of well-oxygenated spring water prevents dissolved oxygen depletion. This is the case in trout ponds with large outflow. Even in such ponds, however, depth greater than 15 feet tends to result in superior fishing. This may be a matter of more room for the fish and a

greater range of living conditions for them—and their food organisms—to choose from.

Having depth of 18 to 20 feet is distinctly better than 15 feet, and 25 feet is still better. Beyond that depth, we aren't sure whether further improvement takes place. The recommendations of 10 to 12 feet for pond depth, which one often sees, are based on conditions in more southerly states and are inappropriate for the harsh winter climate of the northern tier of states.

We recognize that there are two problems which sometimes prevent attaining pond depths of at least 15 feet—cost and unfavorable soil conditions. Excavation costs tend to

become disproportionately higher as depth increases. If money isn't available for digging at least 15 feet deep, it would be well to save up until there is enough rather than creating an inadequate pond and a disappointing fishery.

A soil problem which can occur is when the proper depth cannot be dug because doing so would perforate a clay layer, thereby breaking a natural seal, and allowing the pond water to drain away. It depends on the structure of the soils and should be investigated in advance by SCS or other knowledgeable individuals. If natural clay sealing is broken to achieve proper depth, the pond bed can be resealed with clay, but that can be expensive.

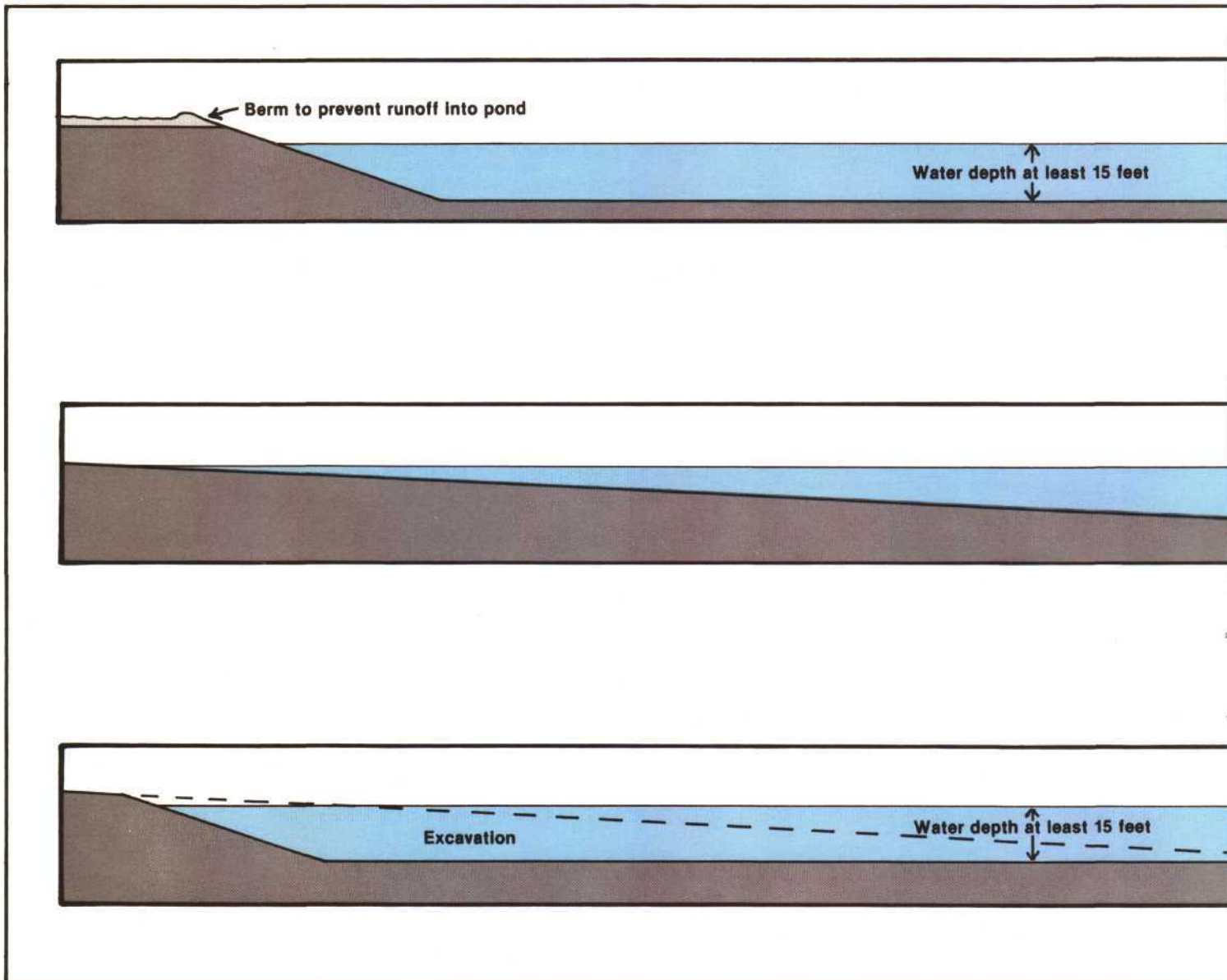

Water Supply

It's advantageous if the pond's water supply is exclusively groundwater, either from wells, springs, or slower seepage, rather than from runoff or stream water. Groundwater tends to be well filtered, whereas runoff and stream water often bring in excessive amounts of nutrient phosphorous and other material. Excessive phosphorous creates the overabundances of plants and other organic matter that cause oxygen problems for fish. Obviously, runoffs from barnyards, pastures, and fertilized or eroding cropland are nutrient sources to be avoided. Fertilized lawns and gardens are other sources. Even

stream water that appears clear and "pure" often carries far more nutrient into a pond—where plants take it up—than it flushes out.

Precautions may also be needed with seepage and spring water. Such water is sometimes too low in dissolved oxygen for fish as it emerges from the ground. It may also be too high in carbon dioxide. Various methods of aeration can alleviate these problems—perhaps at considerable added cost. Excessive amounts of iron and, as it occurs in some places in the Upper Peninsula, copper dissolved in the water can also be unfavorable for fish. Have the water tested before investing in a pond fed by wells, springs or seepage—unless presence

of fish in the same water supply shows its suitability.

Designing for Control of Aquatic Plants

While a moderate amount of rooted aquatic plants may benefit fish in a pond, their overabundance impedes fishing and certain managements. Plant overabundance sooner or later creates unfavorable conditions for fish. Much can be done in design and construction to make a pond less subject to this problem.

Rooted aquatic plants need light and nutrients, and they grow best on rather level pond beds. Therefore, they can be kept in check by structuring the pond so that (1) inflow of

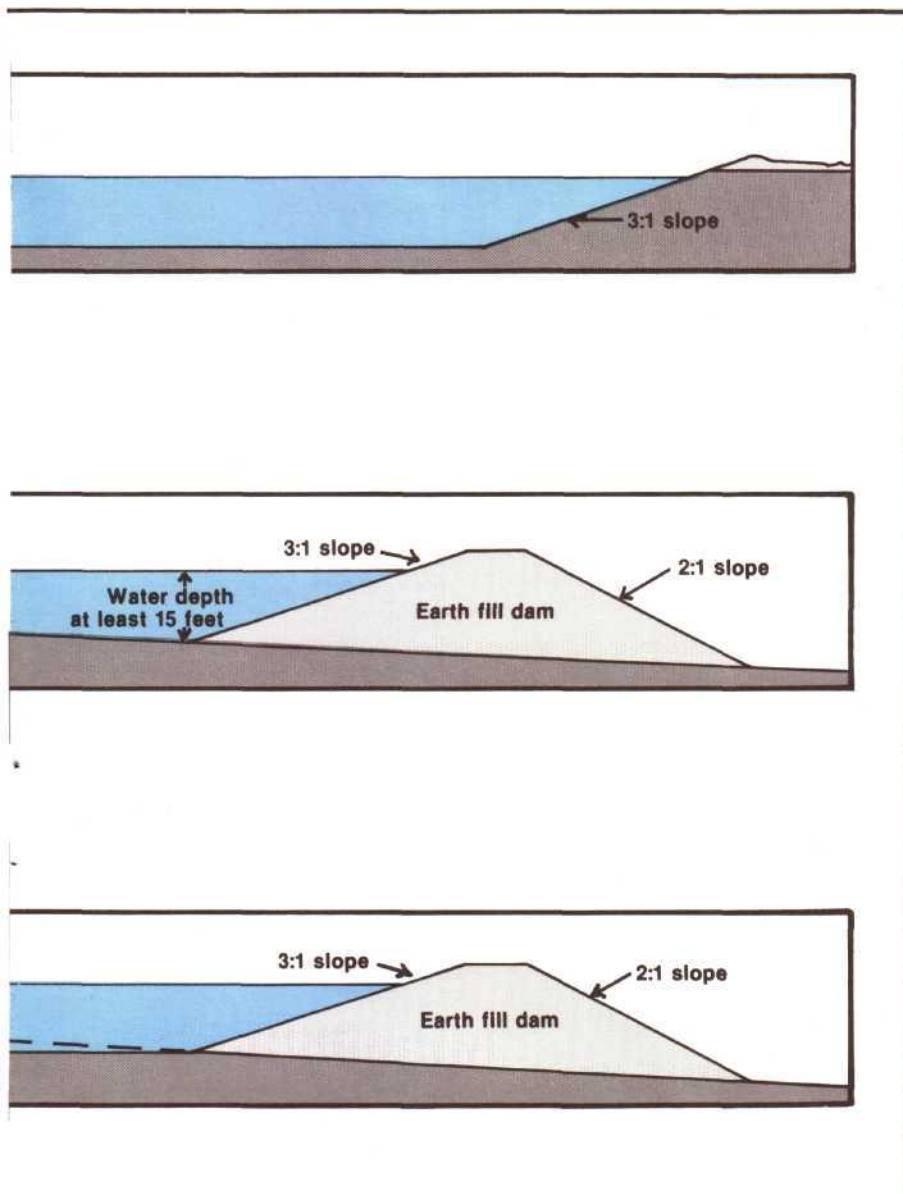

Three types of pond construction.

Excavated or dug pond

Impounded pond

Combination
Impoundment and excavation

nutrients is minimized, (2) much of the bottom is too deep and dark for plants, and (3) the shallow, well-lit side slopes are steeper than plants "like."

One way to minimize nutrient inflow is to locate the pond where little land slopes toward it so little runoff enters. Runoff can also be diverted away from the pond by means of earthen berms, diversions or grassed water-ways. A filter strip of unmowed grass and other low plants along the banks reduces nutrient inflow. Other aspects of erosion control are discussed in the section on landscaping below. If the pond is formed by a dam, an outlet structure that allows discharge from the bottom enables draw-off of nutrient-rich water that accumulates there in summer and winter.

As discussed, making pond depth 15 feet or more keeps much of the bed dark enough to reduce growth of rooted plants.

Submerged side slopes that extend 3 feet into the pond per foot of drop (a 3:1 slope) are sufficiently steep to reduce plant growth while not being so abrupt as to cause unreasonable danger to wading children. If the incline is of fine sand, it is likely to be unstable and slump if steeper than 3:1. Coarse sand, peat, or loam may be stable at a slope of 2 feet horizontal distance per foot of drop, and clay slopes of 1:1 may be stable. If your objectives are plant control and maximum amount of deep water, the steeper the side slopes the better, but a slippery clay incline of 3:1 or greater will be a great hazard to people or animals that might wade or stumble into the pond and be unable to keep their footing.

Surface Area

As a rule, the larger the pond, the more dependable its fish population will be. While trout ponds of only a quarter acre may support passable fishing if they have strong spring flow, most ponds don't provide satisfactory fishing unless they are a half acre or more—preferably much more.

Small ponds may need much more intensive care than large ones. The disadvantages of small ponds may be somewhat alleviated by making them very deep. Pond depth seems even more important to fish populations than pond surface area.

Landscaping and Erosion Control in the Pond's Surroundings

With a little planning, a fish pond and the area around it can be made very attractive. Decide whether you want a natural setting or a more lawn-like one. In a natural landscape, logs, stumps, rocks and uneven ground may be fitting. If much of the area is to be mowed, you may need to smooth the ground and eliminate obstacles during pond construction.

Plant cover should be established quickly on raw areas after construction to prevent erosion. Sod or a heavy stand of grasses and legumes is needed on areas of greatest slope and washing, such as berms, runoff diversion waterways, tops and slopes of dam embankments, emergency spillways, and bank slopes of the pond perimeter. The latter should be quickly vegetated back at least 20 feet from the water.

Deep-rooted plants such as alfalfa, sweet clover, shrubs and trees shouldn't be planted on earthen dams or fill embankments. Deep roots tend to weaken such structures and cause leaks. Some ponds need reinforcement, called "rip-rap," with stone of 8-10 inches (20-25 cm) diameter piled along the shoreline to protect against wave erosion, especially in the case of dam and fill embankments.

Mixed clumps of evergreens and deciduous trees, bordered by shrubs, provide food and cover for wildlife and give the pond surroundings a pleasing appearance. But trees and shrubs shouldn't be planted so near the pond that many leaves fall or blow into the water when shed. Leaves that get into the pond use up oxygen when they rot, and they create layers of litter on the pond bed, as well as furnishing

nutrients for overgrowth of water plants. Keep such vegetation at least as far back from the water's edge as the greatest height the tree or shrub will reach—preferably much farther back than that. It isn't necessary to set evergreens so far back. Trees and shrubs on the shore area may also interfere with fishing.

Fence livestock away from the pond. They destroy vegetation of the pond-bank buffer strip, and their droppings overenrich the water. Grazing and trampling also weaken dams, embankments and spillways. If livestock watering is a purpose of the pond, pipe the water to an area where the animals won't harm the pond.

Excavated or Dug Ponds

Dug ponds are built mostly in rather level areas not suited for ponds formed by dams. Many parts of Michigan are favorable for dug ponds because they are fairly flat, the soils are soft and porous, and groundwater lies close beneath the soil surface. The pond is then fed by water slowly seeping in one side of the pit and out the other. Dug ponds can also be positioned so that springs upwell within the pond or flow into it from a short distance up-slope. Groundwater can be pumped into ponds from nearby wells. Sometimes windmills are used for this. Less desirably (see drawbacks in section on water supply), dug ponds can be catchment pits for overland runoff if soils are clay or other fine material that will hold water—or if clay or other sealants can be obtained to line the pond bed.

Groundwater seepage ponds are the most common in Michigan. They are generally located in sand or sand-gravel soils through which water easily percolates. Such ponds are possible even in many areas with rather non-sandy surface soils because water-bearing sands and gravels lie close beneath, and excavation reaches down into them.

The water level may fluctuate significantly in seepage ponds as the groundwater table rises and falls—higher in wet years and wet seasons,

lower during drought. Plan excavation depth to be more than 15 feet below the lowest level that the groundwater table reaches in a very dry year. Consult an SCS engineer, or other field personnel, for such a determination. Make test borings to find the water table in late summer of a dry year.

When contracting for a dug seepage pond, obtain written agreement from the contractor as to the water depth that will be achieved. Contracting for a certain pit depth will do little good if the water doesn't rise sufficiently in it. Again, 15 feet or more depth during the low point of summer water levels is advisable, if soil conditions permit.

The type of equipment that is best for digging ponds depends largely upon pond size, site characteristics, and depth desired. Draglines or bulldozers are generally used. Bulldozers are more adapted to the dryer pond beds.

The material dug out of the pond, called the "spoil," should be

smoothed back away from the pond edge or piled far enough from the pond that it won't erode back into the water. Using some of the spoil to build a gentle berm around the pond can be helpful in diverting unwanted overland runoff away.

Ponds dug by draglines are seldom wider than about 90 feet but may be much longer. Excavation width is governed by the distance a dragline can move back before it is blocked by its spoil piles—unless the spoil can be moved.

Impoundments

In "embankment" or "fill-type" ponds, water is impounded by an earthen dam containing a core of watertight material. Such ponds are suited to areas where slopes range from gentle to steep. It is best to have a site where a great volume of water can be stored by only a small amount of embankment fill. The ideal location is where the valley is narrow at the damsite, and the pond

area is wide and flat but with steep sides.

For fishing ponds, avoid damming a stream. As described earlier in this chapter, they are collecting basins for silt, sediment, and debris, and undesirable fish species can easily enter the pond. One or more permits may be needed depending on applicable state laws. Also avoid sites where the impoundment dams a river or stream and where there is flooding.

Wave erosion on the dam embankment can be a problem in large ponds. Try to choose a site where the prevailing wind doesn't blow along the length of the pond toward the dam.

A properly designed impoundment will have two outlets for the water—a trickle tube or mechanical spillway and a vegetated earthen emergency spillway. The emergency spillway is for flood flows.

As in the case of dug ponds, it will be best for fish if the water supply is from groundwater rather than from runoff. If, however, the impound-

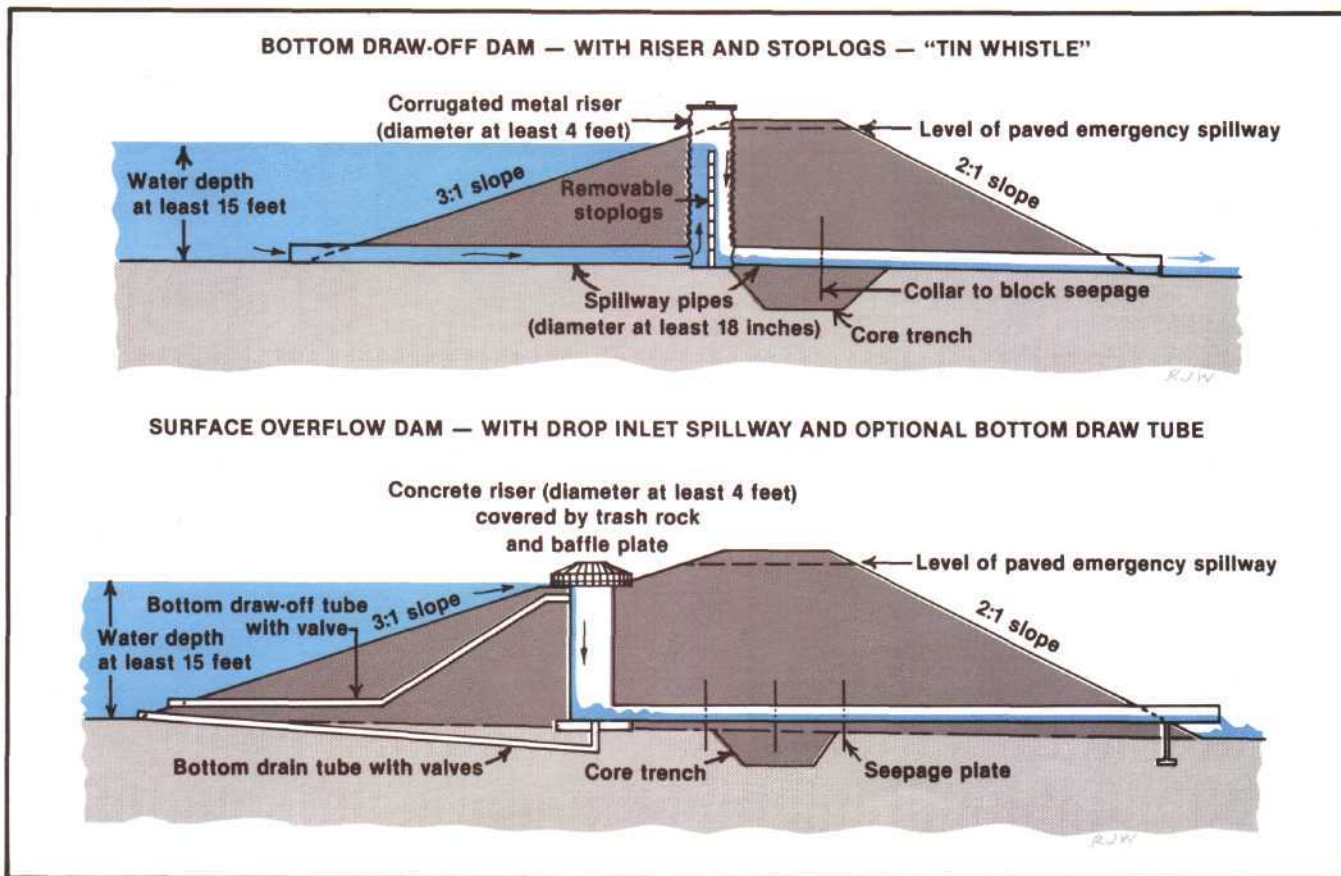

Two common types of outlet structures for dams that form fish ponds. Riser-and-stoplog construction is the simplest design that allows controlled bottom draw-off. A drop-inlet spillway can accommodate greater variation of flow. It is needed where run-off from large land area supplies the pond and where sudden high water is expected.

ment must be designed to catch runoff water, the pond must be located so that its drainage basin is large enough to provide sufficient runoff to fill it—and to maintain it in the face of evaporation and seepage losses. Calculate surface runoff according to the area of land draining into the pond, amount of precipitation, and runoff characteristics involving land slope and porosity, vegetation, and human disturbances of the land. For a Michigan pond that depends entirely on runoff water, 8 to 14 acres of runoff

basin land are needed per acre of pond surface.

Clay and silty clay are good soils for impoundment beds. Sandy clay is suitable only if the cost of extra materials for sealing the pond is acceptable. Sites in some areas of limestone or gypsum are especially unsuitable—even hazardous—for impoundments. There may be crevices allowing water to drain from the pond. A fair clue to the success of building impoundments in such areas is the previous experience of nearby pond owners.

Soils for earthen dams should be about 20% clay by weight and contain a wide range of particle sizes, varying from fine sand to coarse sand or gravel. The earth must be compacted to minimize percolation through the dam. To insure proper compaction, soil moisture must be controlled in certain ways during construction.

For the dam's vegetated spillway, clay, sandy clay and silty clay are suitable. Avoid loose sand and other easily erodible soils.

Ponds As Places For Fish To Live

Basic Pond Characteristics for Natural Production of Fish

The ideal Michigan sportfishing pond has:

- a surface area of one-half acre (one-fifth hectare) or larger,
- steep side slopes (about one foot vertical per three horizontal),
- at least a quarter of the bed 15 to 25 feet deep (5-8 meters),
- a water supply exclusively by seepage of groundwater (rather than stream water or runoff from land—even during the hardest rains and greatest snow-melt),
- 150-250 parts per million dissolved minerals,
- an acidity-alkalinity rating of 7-8 on the pH scale,
- a location in land with fertile soil,
- an inflow of only moderate amounts of nutrient chemicals—amounts such as would enter the pond if the land were covered by natural, undisturbed vegetation (inflow only of groundwater helps avoid excessive nutrient enrichment),
- a moderate amount of rooted plants and algae grown from naturally moderate amounts of nutrients—less than $\frac{1}{4}$ of the pond bed covered by dense plant growths,
- concentrations of dissolved oxygen which seldom fall much below 5 parts per million, even in the deepest water,
- a balance between amount of fish and amount of natural food so that body growth is rapid.

These **ideal** guidelines apply regardless of whether the pond is for warmwater fishes or for trout. A pond can have somewhat different characteristics in any of the categories and still produce worthwhile fishing. In many locations, some of the ideals cannot possibly be met, even with considerable management. For example, regulating the dissolved mineral content of groundwater will usually be infeasible, and one should not hesitate to have a pond just because the water has only 50-100 parts per million.

An ideal coldwater pond for trout will differ from a warmwater pond primarily by having greater seepage of well-oxygenated groundwater (springs), which keeps water temperature lower in summer.

This section of the bulletin briefly explains why the previously mentioned pond characteristics are important to the well-being of fish. The functioning of ponds is complex, but it is understandable and predictable enough that knowledge of it can help us manage for better habitat and food supply for kinds of fish that the owner wants—and thereby to achieve sustained fishing quality.

The Pond Ecosystem

The pond is an organized system of water, soils, dissolved substances and living organisms. We call this the pond ecosystem. Its vast number of parts continually change and interact, driven by energy from the sun, wind and gravity.

Matter and energy enter and leave the pond continuously. Most minerals and organic materials that wash, flow or fall into the pond are trap-



Flow of energy and matter into and out of the pond and its drainage basin.

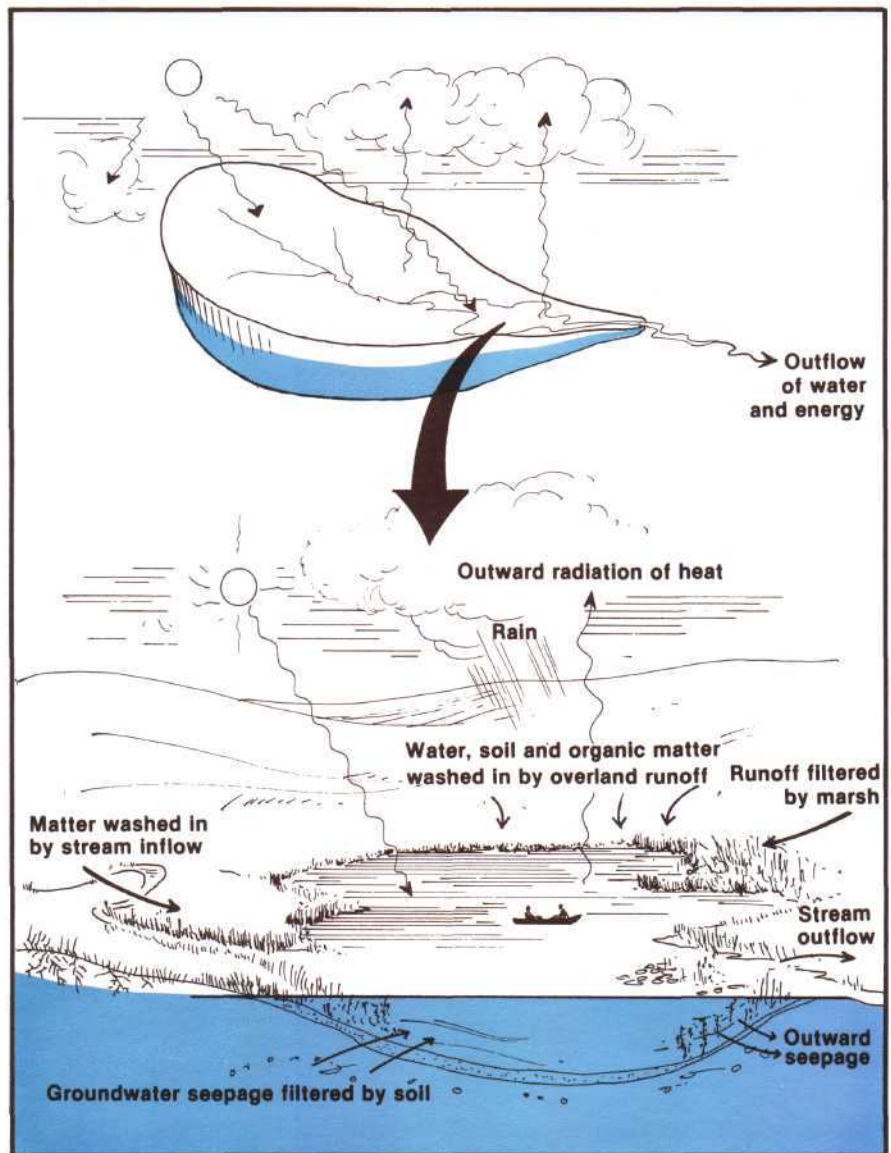

ped and stored there. In contrast, most water and gases that flow in soon flow out again. The pond's energy is always dissipating outward as heat, and pond processes can continue only if it is replenished.

The pond ecosystem is part of the larger land-and-water ecosystem of the area which drains toward it, called the drainage basin. What goes on in the drainage basin greatly affects happenings in the pond. For example, disturbance of vegetation in the drainage basin may increase runoff of rainwater and the amount of soil it washes into the pond.

Some solid mineral and organic matter that reaches the pond settles to the bottom, and some is broken up and dissolved. Much mineral and

organic matter enters in the dissolved state. Plants use the dissolved chemicals as nutrients to make more plant matter.

Some plants are eaten by animals, and some die and fall to the pond bed. Some of the plant-eating animals die and drift downward, too, while others are preyed upon by other animals—which in turn may be eaten by still others. The plant and animal material which animals consume is either stored in their bodies or passes out into the water again as solid or dissolved wastes.

The dead plants, dead animals and wastes undergo at least partial decomposition and redissolving by the action of scavenger animals, microorganisms and chemicals. The

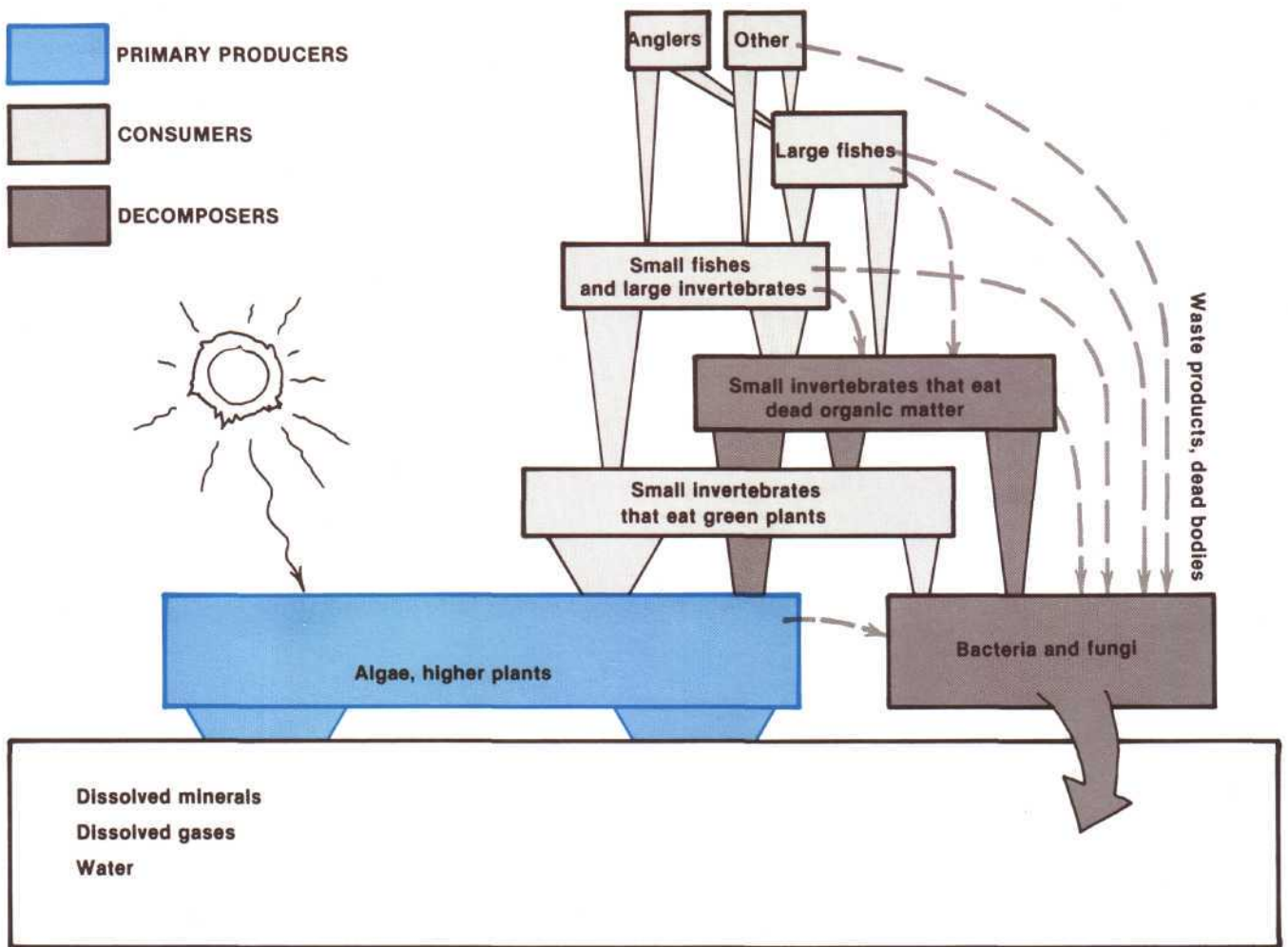

The food pyramid of a pond. The total mass of organisms at any level requires a far greater amount of matter for support in the level below it. Disparity between amounts at each level is far greater than shown.

redissolved material serves as nutrient for further plant growth. Those materials not completely decomposed pile up on the pond bed, forming organic mud.

Thus, little of the mineral and organic matter that comes into a pond leaves it, even if there is outflowing water. Only a bit departs in flights of emerging insects or in fish carried away by natural predators or anglers.

The interlinked food relationships between organisms form a "food web." The web-like structure gives stability to the fishes' food supply and to the pond's living community. When a part of the web breaks, as when a disease kills off one kind of animal, other kinds remain which may substitute in its role as food for some animals and as a consumer of other organisms—until repopulation of the devastated animal can take place.

When we manipulate a pond ecosystem to make it produce especially great amounts of one or several kinds of fish, this often involves a lessening of the kinds of habitats and kinds of organisms in the pond. This removes many links of the food web and may make the living community less stable.

For example, we purposely build ponds to have little diversity of habitat so that only a few kinds of organisms can thrive there—the fishes we particularly want and a few kinds of food organisms for them. We build uniformly steep pond side slopes to discourage plants because they interfere with fishing and allow development of too many young fish. We dredge smooth, deep pond bottoms suited for maximum fish growth and for seining to remove undesired fish. We try to ensure a short, efficient food chain by stocking only one or

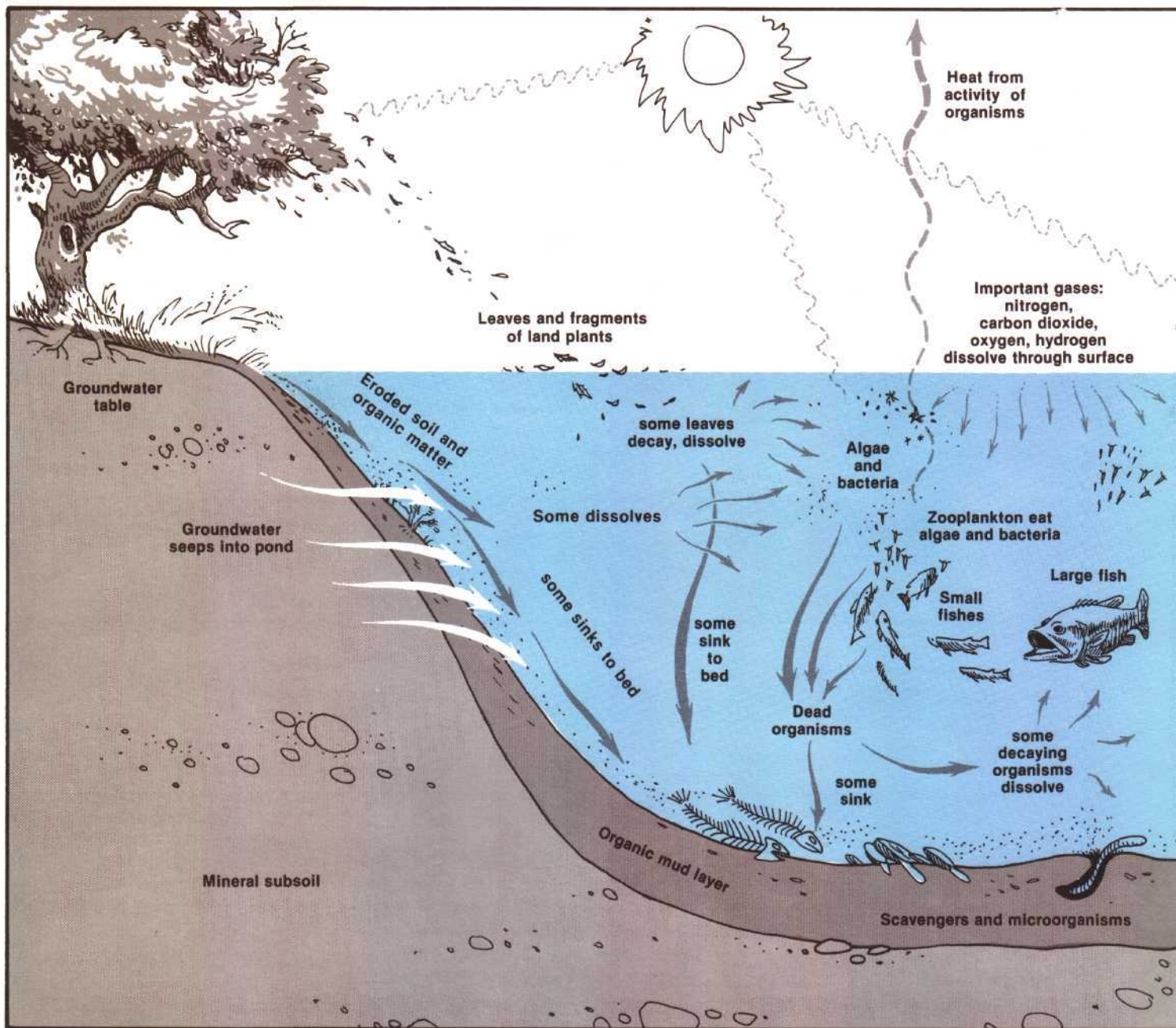

two kinds of fish and by eradicating all others.

Such artificially shortened food webs boost production of the intended kinds of fish. This is usually what the pond owner wants, rather than an “interesting” natural community of fish that doesn’t provide as much angling. But we should realize that the simplified community may be less able to bounce back from occasional catastrophes such as disease, cold snaps, and drought. Substantial and repeated management is often needed to keep an un-

natural pond community the way the owner wants it. There is a saying in pond management that “once you start managing, you have to keep managing like mad.”

Another bothersome kind of imbalance and instability in the pond’s community of living things happens when there is an insufficient number of predator fishes (bass). Then small fish (bluegills, other sunfishes, minnows) may become so abundant that the water flea population is cropped down to numbers that can’t consume much of the algae that are pro-

duced. This leads to an overabundance of algae, which is not only unsightly and foul smelling but also reduces dissolved oxygen in the pond depths.

Consequences of Overenrichment

A pond’s suitability for fish can deteriorate severely if its supply of nutrient phosphorus becomes great, as when topsoil, leaves, fertilizers, or human and livestock wastes flow

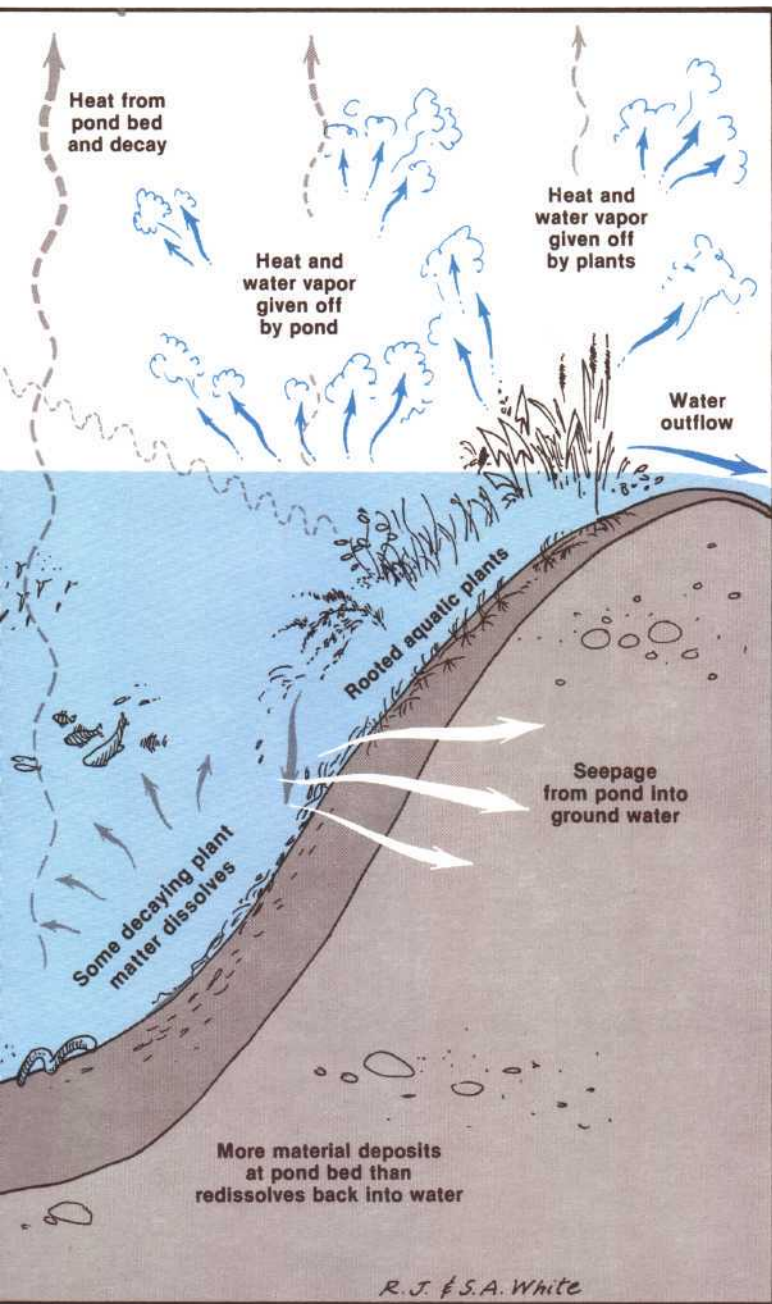

Inner workings of the pond in rough outline. This sketch of movement of energy and matter looks complicated, but the actual situation is far more complex. Most mineral and organic matter entering the pond becomes trapped in it and is to some extent recycled. Most energy that enters from the sun leaves again rather soon. Water also flows through.

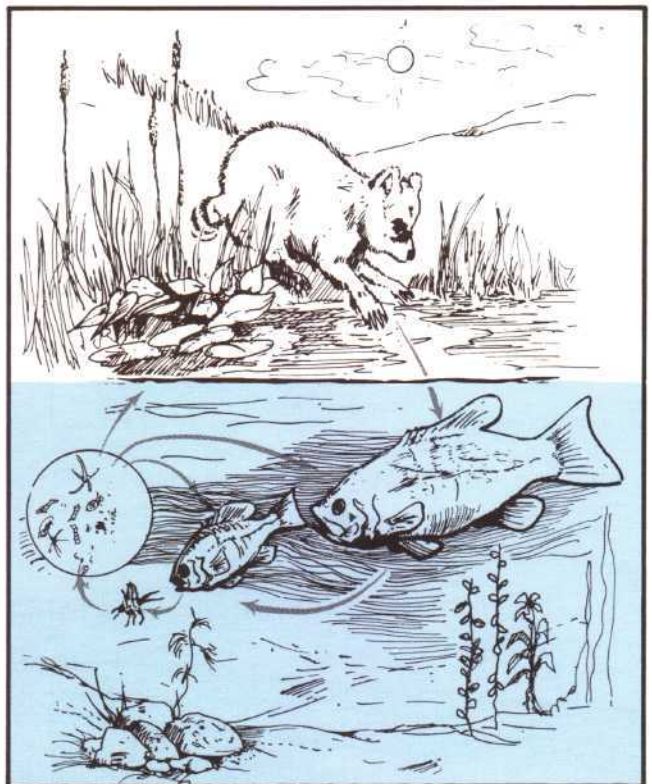
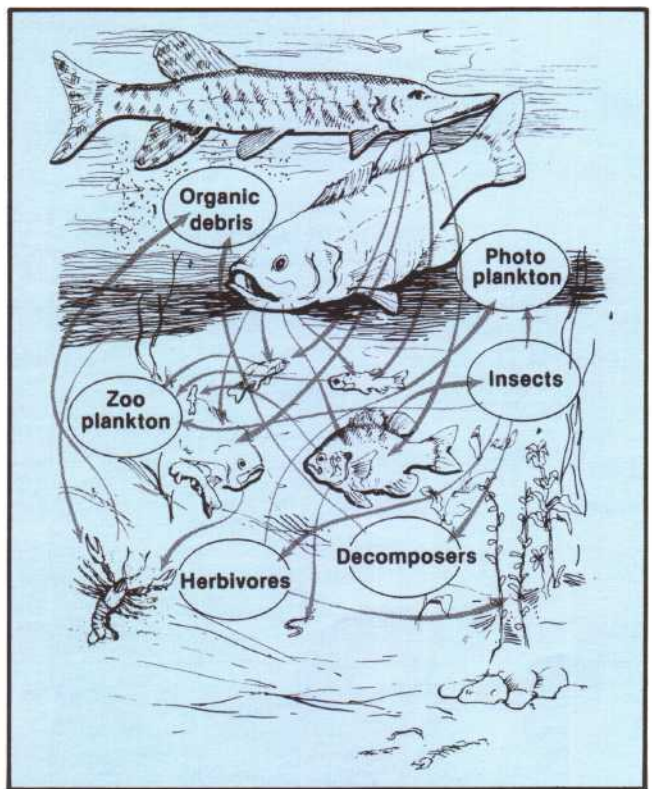

Food web (top) and food chain (bottom) contrasted. The arrows point in the direction of predatory or "grazing" pressure. A chain-like system may produce more of certain fishes that we desire, but a break in one link may severely disrupt production. The web-like system has many more parts and is therefore more stable and more productive in total—but not necessarily of the fishes which anglers most appreciate.

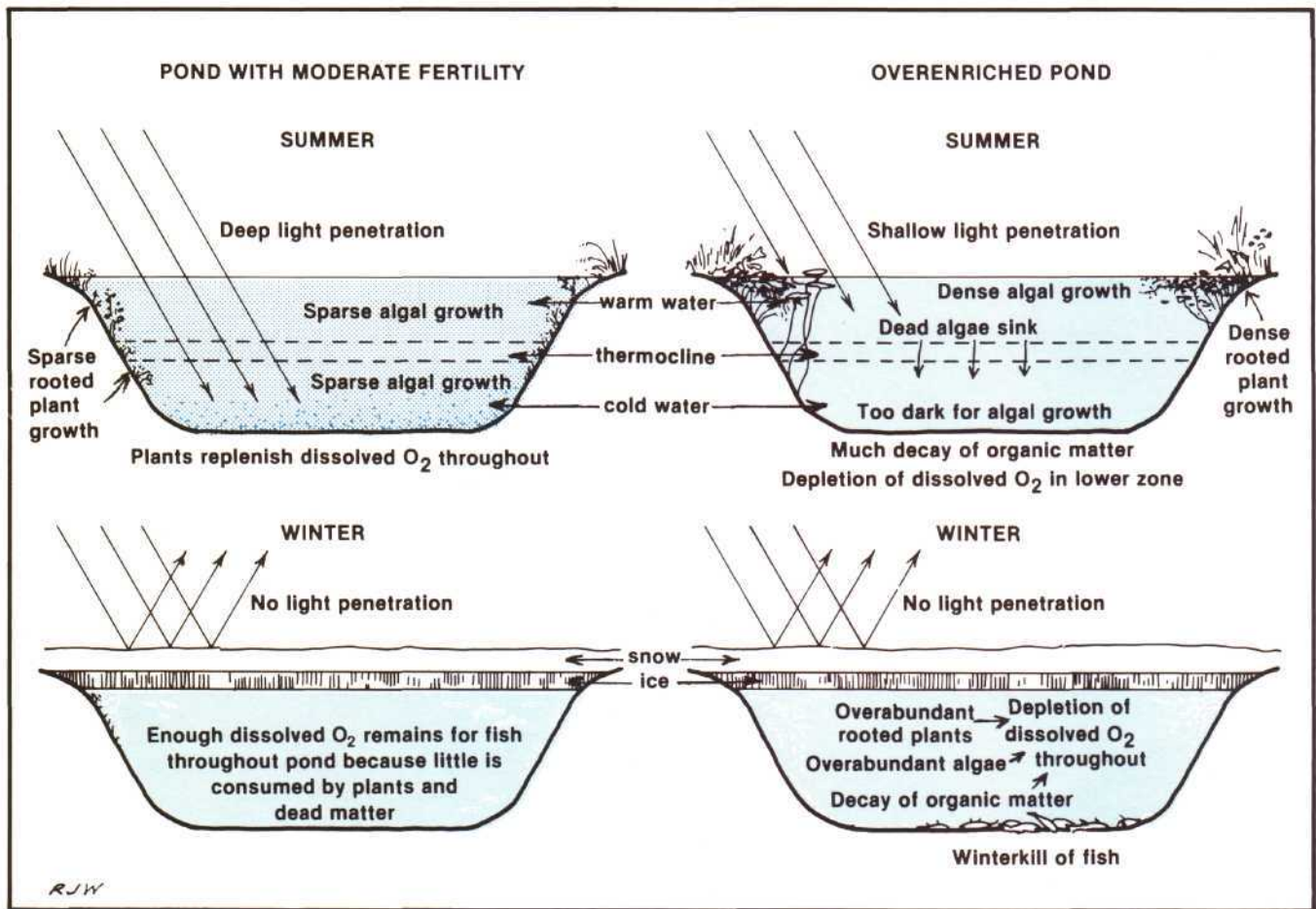

The hazards of pond overenrichment.

in—or if fish feed is added. Algae and other plants then become overabundant. Stagnant lower layers may lose dissolved oxygen and have such build-up of toxic gases in summer and winter that fish become sick or die. This problem is especially acute in winter under ice cover, and mass die-offs of fish, termed "winter kills," are common in shallow ponds with much organic matter.

Facts About Water and Chemicals Dissolved in It

Water is the chemical basis of life. It moves and carries things with it, including the many substances it dissolves. It affects light entering a pond. It buoys up plants and animals of a pond. It changes in density as it changes in temperature and chemical content. Water is almost unique among substances in

being lighter as a solid than as a liquid. The fact that ice floats atop ponds in winter rather than growing upward from the bottom (or falling there after forming at the surface) is profoundly important to pond life.

Although rain and snowmelt water wash solid and dissolved substances from the land, a pond can often get much of the carbon, nitrogen, oxygen and hydrogen its organisms need right from the gases in the air. Pond water can be rich or poor in other plant nutrients (calcium, potassium and phosphorus), depending on their abundance and solubility in the surrounding land.

Many ponds have only low or moderate amounts of aquatic vegetation in them because, although all other conditions are right for growing many plants, little phosphorus enters from surrounding land. A well-vegetated landscape will permit even less phosphorus to enter the pond. In such situations, phosphorus is the "limiting factor."

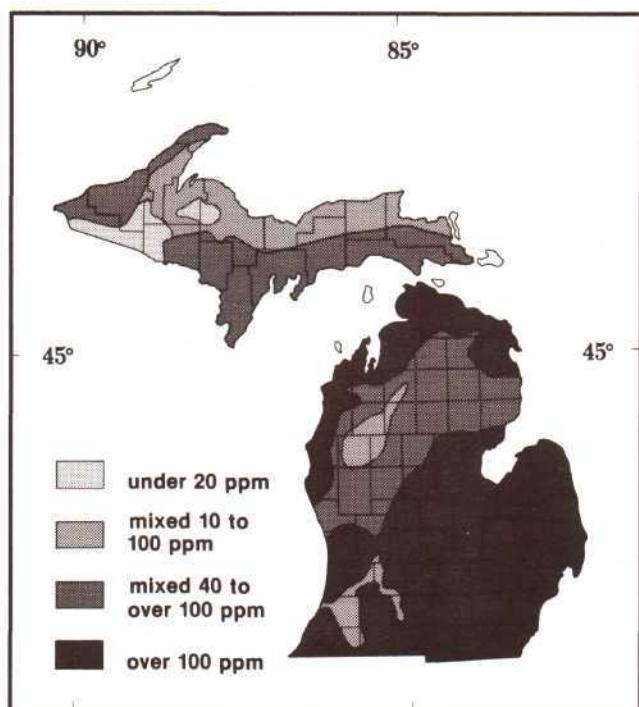

Pond alkalinity regions of Michigan. Most of the regions have a rather broad mixture of water alkalinities.

Table 4-1. Pond carrying capacity related to alkalinity of the water. These are very rough indications of how much fish can be supported by naturally-occurring food in a pond. Particularly for trout, much greater amounts can be sustained in the pond by artificial feeding, but with drawbacks explained in Chapters 7 and 8.

Alkalinity of water	Approximate carrying capacity (pounds/acre)			
	Warmwater ponds			Coldwater ponds
	Bass or catfish	Bluegills or other panfish	Total**	Trout**
More than 100 ppm*	50-100	200-400	250-500	150 or more
40 to 100 ppm	25-50	75-200	100-250	25-150
Less than 40 ppm	under 25	under 75	under 100	under 25

*parts per million

** In warmwater ponds, much of the total poundage will be in the form of young fish that are too small for angling. In coldwater ponds, all or most of the trout will usually be large enough for angling—and the poundage shown may provide about as much fishing as that shown for warmwater fishes on the same line.

The amount of phosphorus dissolved in the water does indeed limit, in most ponds during the growing season, the algal and leafy plant production which is the basis of the food web. Increasing the amount of phosphorus increases total production of pond life—but this does not always result in greater production of fish. Often only a portion of total algal production is from kinds of algae that are useful to fish. The size of that portion depends on the **alkalinity** of the water.

Alkalinity is the amount of certain minerals dissolved in the water. The main constituent in the alkalinity of Michigan water is usually calcium carbonate (CaCO_3), the “lime” we see deposited in the bottom of a tea kettle when “hard” water is heated and evaporated.

When water is of **low alkalinity**, presence of a small amount of phosphorus results in small amounts of the kinds of algae that water fleas and other fish food organisms like to eat. As more and more phosphorus is added to low alkalinity water, however, a point is soon reached where these beneficial algae cease to increase. Instead, the added production takes the form of “bluegreen” algae, a class which

algae-eating animals don’t like. Thus, rather than supporting the food web that leads to more fish, bluegreen algae proliferate without being cropped back by grazers, reach nuisance abundances, die, and directly support decay bacteria—which become so abundant as to draw excessively on the pond’s supply of dissolved oxygen. The result of too much phosphorus for the amount of alkalinity is, then, a condition of occasional oxygen stress which may harm fish.

Water that is more alkaline will enable more phosphorus, if present, to grow a greater amount of the kinds of algae that result in more fish. At any level of alkalinity, however, there still can be a phosphorus level above which bluegreen algae will begin to dominate the pond.

Thus, the more alkaline a pond is, the greater its potential for producing fish. But the fulfillment of that potential will be seen only if there is just the right amount of phosphorus and if other conditions, such as temperature, are also just right.

There are other benefits from moderate to high water alkalinity, as well. Alkalinity helps avoid a variety of chemical conditions unfavorable to fish and other aquatic life. The dissolved minerals “buf-

fer” against extreme acidity. Acids can come from various sources. For example, rainwater is becoming increasingly acidic, owing to air pollution of certain kinds, and this is making conditions unsuitable for fish in ponds that aren’t well buffered. Alkalinity also maintains conditions in which fish are less subject to poisoning by the presence of certain dissolved metals.

Michigan ponds range in alkalinity from about 4 parts per million (ppm) to over 300 ppm. Most are between 50 and 240 ppm. Alkalinity of 40 ppm seems to be a pivotal value below which fish production declines and above which fish production is moderate to high, but with no steady trend of increase with increasing alkalinity because of variability in other key conditions.

Pond Breathing, Circulation and Stratification

A pond exchanges gases with the air above it. This is a form of breathing. The gases and other dissolved and drifting materials are moved about the pond by water circulations caused by wind and gravity. In winter, ice may greatly reduce

circulation and almost completely block pond breathing. In both summer and winter, the pond sorts itself into layers representing a gradation of temperature, hence different density. The heaviest water lies on the bottom and the lightest at the top. During summer stratification or layering, only the upper part of a deep pond will be circulated by the wind. The lower part will be rather still. Summer and winter stratifications are usually broken up in fall and spring during the time that cooling and warming change all the water to an equal temperature and equal density. These events are described in the figure at right.

Investigating Pond Suitability for Fish

Pond owners often ask if the water can be tested simply for fertility and other chemical characteristics to evaluate its fish-producing capacity or to find out why fish haven't done well. Determining these things is far more involved than just sending water samples to a laboratory. As previously described, ponds are complex, and their conditions change continually. The foremost need is to be alert against land disturbances, water runoff into the pond, and human or livestock wastes that could cause overenrichment. Such observation of the pond's surroundings, combined with a program of water temperature and dissolved oxygen measurement in the pond, may provide enough information for pond management.

Judging a pond's productive capacity or diagnosing its problems is best done by a professional biologist. (Obtain list of consultants as shown in Appendix.) Properly trained aquatic biologists can evaluate conditions of the pond site and surroundings and can interpret temperature and oxygen data. At considerable added cost, the consultant should be able to make key measurements (alkalinity, pH, inorganic nitrogen, phosphorus, temperature and a few others) using special instruments and methods just after the ice goes out in spring, and with the results estimate total

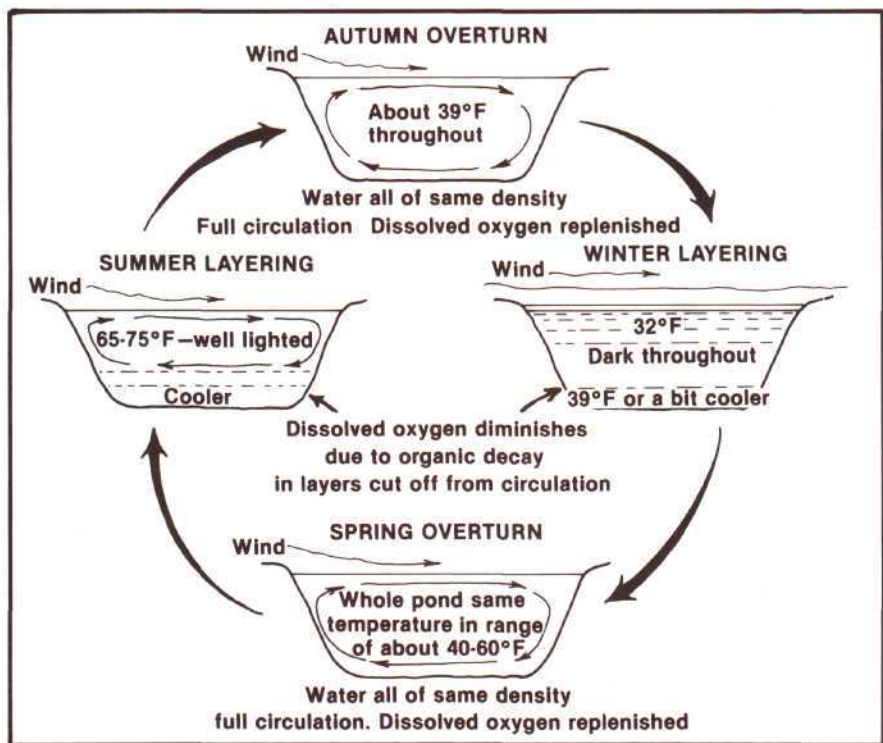

production of algae and the amount that contributes to the food web for fish—as well as the amount that will be in the form of bluegreen algae. Such a detailed analysis should result in advice on adjusting the balance of alkalinity and phosphorus for best fish productivity.

The pond owner may be able to participate with a professional biologist in pond investigation—or, after study of references, may undertake measurements on his/her own. Much depends on knowledge of science, the amount of time one can spend, and the instruments and materials available. Various handy analysis kits for dissolved oxygen and other determinations are now sold (see Appendix).

Professional help is especially advisable with regard to **design** of the investigational program and **interpretation** of the results. Design involves planning the right sampling at the right times. Interpretation involves judging what the data mean in terms of pond biology and what the implications for management are.

Knowing **maximum water depth** and calculating **mean depth** are important, as are observing **abundance of aquatic plants** and keeping

Circulation and thermal (or density) layering of water in ponds. Not only temperature but amount of oxygen available to fish is strongly influenced by the progression of circulation and layering through the seasons. Very shallow ponds (not shown) may have complete circulation for much of the summer, but they are much more likely to have depletion of dissolved oxygen in winter.

records of fish caught (species, length and weight). It is essential to identify possible sources of phosphorus overenrichment, such as septic systems, livestock wastes, soil and fertilizer erosion, and roadway runoff.

Much of direct importance to fish can be learned by systematically monitoring **dissolved oxygen (DO)** and **water temperature** within the pond. Along with the chemical kit for DO measurement, a special sampling device (DO sampler) should be obtained (see sources in Appendix).

Crucial times to analyze water temperature and DO are (1) in mid or late summer after a week or more of very hot weather and (2) in winter after ice and snow have been on the pond for a month or more. For a more detailed picture, monitor the

Table 4-2. Water temperature at various depths¹ in an example of a pond, measured on the 15th of each month at the deepest point in the pond which is 18½ feet deep. These are same measurements shown in the figure at right.

Water depth (feet)	Temperature (°F) at Mid-Month											
	Jan ²	Feb ²	Mar ²	Apr	May	Jun	Jul	Aug	Sep	Oct	Nov	Dec ³
surface	32	32	44	50	60	67	71	75	62	51	46	32
2	36	33	44	50	60	67	71	75	62	51	46	39
4	38	36	44	50	60	67	71	75	62	51	46	39
6	39	38	44	50	60	67	71	75	62	51	46	39
8	39	39	44	50	60	67	71	75	62	51	46	39
9					60	67	71	75	62			
10	39	39	44	50	58	62	65	70	60	51	46	39
11					52	55	58	61	57			
12	39	39	44	50	50	52	53	54	54	51	46	39
14	39	39	44	50	50	52	53	54	54	51	46	39
16	39	39	44	50	50	52	53	54	54	51	46	39
18	39	39	44	50	50	52	53	54	54	51	46	39

¹Measurements made at regular 2-foot intervals, except at one-foot intervals in areas of rapid temperature change.

²Pond covered by ice.

³About one week after ice has melted.

Figure at upper right:

General example of water temperature change during the year in a small, fairly deep “warmwater” pond. These are plots of some of the data in Table 4-2.

Variation can be great between different ponds and from one year to the next in the same pond, depending on water depth, wind strength, air temperature and other factors. Temperature affects water density. Water is heaviest at 39°F (4°C). Thus, water nearest 39°F tends to be at the bottom, with warmer—or, in winter, cooler—water floating on top of it. This vertical density layering, when it occurs, results in a gradation of temperature from top to bottom. Then fish can choose the depth offering preferred temperature—if not prevented by insufficient dissolved oxygen.

Winter Layering—Ice covers the surface. Water is 32° just under ice and is progressively warmer at greater depths. Deepest water is near 39°. Warming by groundwater seepage may alter the curve.

Springtime Overturn and Even Warming—After ice melts in March of April, wind mixes water evenly throughout as the pond warms. Temperature stays equal from top to bottom as warming occurs.

Late Spring and Summer Layering—Will not often occur in many ponds, especially not in ones shallower than shown here. Layering happens if upper water becomes, by intense warming, so much lighter than lower water that wind cannot overcome the density difference and can no longer mix all the way to the bottom. Then mixture occurs only in upper water. The well-mixed upper layer has a thinner layer of water with rapidly decreasing temperature between it and the cooler water below.

The upper layer will usually extend deeper than shown. Wind may become strong enough to destroy layering after it has formed.

Seepage of very cool ground water into the pond may make layering more distinct and stable.

Autumn Overturn—Surface water cools, becomes denser, and sinks, mixing with warmer water just beneath. Thus, upper layer is cooled to density near that of lower layer, and wind can mix the whole pond again. Complete fall mixing can occur solely by sinking of upper water as the weather becomes colder; wind is not needed. Fall overturn halts when ice blocks wind action and upper water becomes colder, hence less dense, than water beneath it which is nearer 39°F.

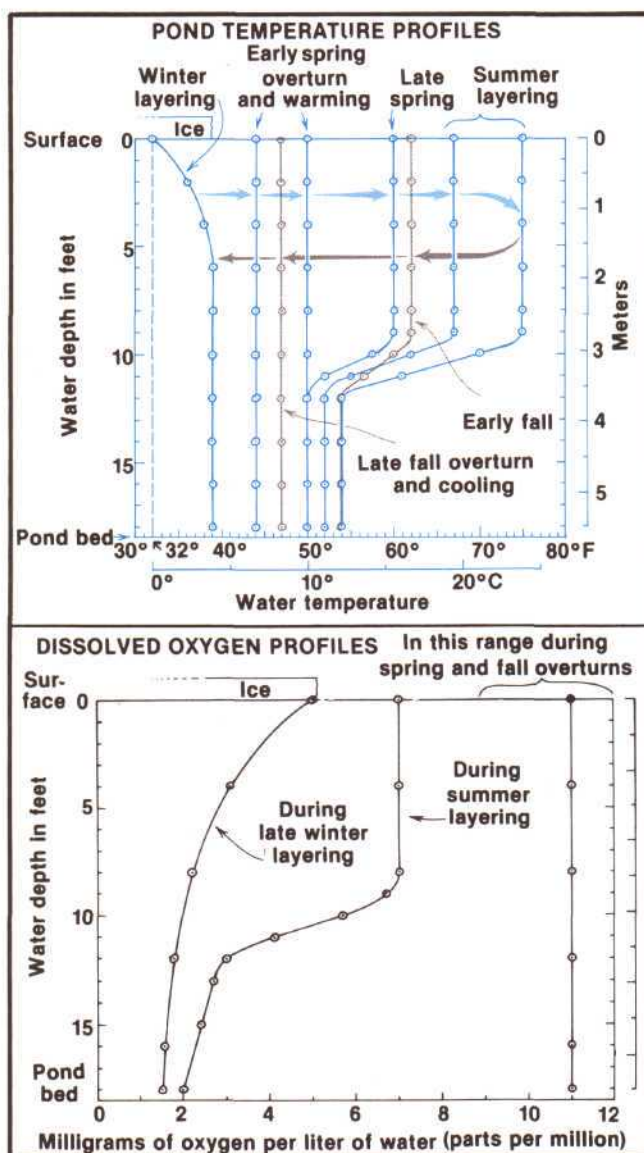

Dissolved oxygen at different depths in the same pond, as affected by the wind mixing and thermal/density layering shown in the figure on page 20.

During Spring and Fall Overturn—Large amounts of oxygen can dissolve into the pond from the air because water that is cooler can hold greater concentration of dissolved gases. Amounts of dissolved oxygen are the same at all depths because water is well circulated throughout. Concentrations of 9-12 ppm commonly occur.

During Summer Layering—Warmer water of upper layer cannot hold as much dissolved oxygen as could the cooler water in spring time. Cool water of the deep layer could hold more dissolved oxygen, but decay of organic matter consumes oxygen, and the lower water cannot obtain more because density layering prevents it from being circulated into contact with the atmosphere. Therefore, dissolved oxygen decreases in the lower layer, and it may become unfit for fish.

During Winter Layering—Ice and snow block entry of light and of oxygen. Plants have too little light for photosynthetic production of oxygen, and none can dissolve into the pond from atmosphere. Respiration and decay consume dissolved oxygen. Concentrations decrease the most near pond bottom where there is more organic matter. Fish are forced upward into layers having sufficient dissolved oxygen.

complete annual cycle of pond temperature and DO by sampling every week or two.

In summer, make temperature and DO measurements before 6 a.m. and again at 3 p.m. Sample at intervals of 1-3 feet (30-100 cm) throughout the water column where the pond is deepest. (Once found, this point can be marked with a simple buoy, such as a plastic milk carton on a string attached to a brick.) If an electric thermometer isn't available, use a fisherman's thermometer encased in a water-collect-

ing vial (available at sporting goods stores). Lower to desired depth, then wait for the thermometer to adjust to temperature.

Results of the temperature and DO measurements should be recorded as tables and possibly also as graphs. Examples are shown on page 21. These are called temperature and DO profiles. If taking and analysing DO samples at each of the depth intervals is too time-consuming, then take just a few key samples. For example, take one at the bottom of the pond, where DO

is most likely to be inadequate, and one at a medium depth.

General guidelines for determining suitability of ponds for warmwater or coldwater fishes are covered in Chapters 7 and 8 on management for fishing in each of these kinds of ponds. Proper temperature and DO levels are discussed there.

Additional reading of literature on pond and lake biology is recommended, especially if the owner intends to make and interpret his/her own measurements. A list of references is at the end of the bulletin.

Kinds of Fish To Use In Ponds

It's important to know something about the lives of fishes used in ponds. Each species differs from all others in its characteristics of feeding, surviving, growing and reproducing. Ponds should be designed and managed with specific requirements of the fish in mind. If the pond environment is unsuitable for the kind of fish stocked in it, reduced growth, insufficient reproduction, or poor survival may result.

There are two basic categories of pond fishes—**warmwater** and **coldwater** fishes. Warmwater fishes such as bass, bluegills, other panfishes, or catfish, do best in ponds where summer water temperature is more than 70°F (21°C). A pond may be suited for coldwater fishes (the various kinds of trout) if summer water temperature remains below 70° when measured a foot below the surface near the center of the pond and if **dissolved oxygen concentration stays above 5 ppm**.

The so-called “coolwater” fishes such as northern pike, muskellunge,

walleye and perch, generally don't thrive in small bodies of water. They aren't considered suitable for pond fisheries in Michigan.

Information on stocking, harvest and other management is in Chapters 7, 8, and 9 of this bulletin. Information on where to get fish for stocking is in Chapter 6.

Coldwater Fishes

The coldwater fishes include trout and their relatives such as salmon, grayling and whitefishes or ciscoes. Of these, only trout are presently considered suitable for coldwater sportfishing ponds in Michigan. To survive and grow well, trout require water temperatures that seldom rise above 70°F (21°C). Dissolved oxygen levels should stay above 5 ppm, which is high compared to the needs of warmwater fishes.

As with other fishes, trout growth varies greatly between ponds, depending on food supply, crowding, and size of fish.

Trout eat a wide variety of organ-

Table 5-1. Summer length ranges at various ages for fishes in Michigan ponds. These are rough statewide values. Growth may be somewhat greater where fish are uncrowded and temperature and food supply are ideal. Growth can be much slower, especially where ponds are overpopulated.

Kind of fish	Length in inches					
	First summer (Age 0)*	Second summer (Yearling)	Third summer (2-yr-old)	Fourth summer (3-yr-old)	Fifth summer (4-yr-old)	Sixth summer (5-yr-old)
Rainbow trout**	4-6	9-14	14-17	15-19	***	***
Brook trout	2-4	6-8	8-12	9-14	11-16	***
Largemouth bass	1-4	6-8	8-10	10-12	12-14	13-17
Smallmouth bass	1-4	4-7	7-10	10-12	12-14	13-17
Channel catfish	1-4	5-7	8-10	11-13	13-15	15-17
Bluegill	½-2	3-4	4-5	5-6	6-7	6½-7½

*Fingerling.

**From fall-spawning stock in hatcheries.

***Very few survive to this age, and growth at this age is extremely variable.

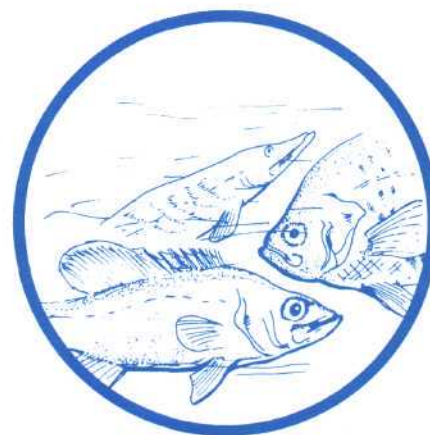

Three kinds of trout that can be used in coldwater ponds. The brown trout is usually not advisable, however.

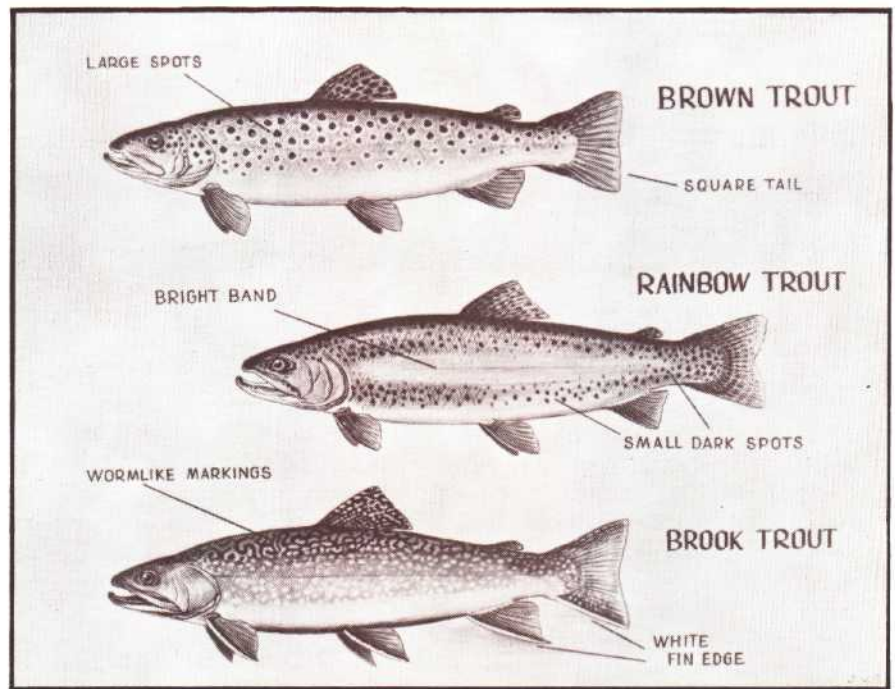

isms. They prefer zooplankton, insect larvae and crayfish. Supplementary feeding is **not** recommended unless large numbers of trout are stocked.

Trout spawn on gravel beds in streams. They don't spawn successfully in most ponds. Populations are maintained by periodic stocking. Brook trout can sometimes reproduce in gravel or coarse sand where springs upwell in pond bottoms.

Rainbow Trout (*Salmo gairdneri*)

Rainbow trout are the most adaptable of the trouts for use in Michigan ponds. They are readily available from dealers, grow fast, are easily caught, can withstand warmer water than other kinds of trout, and generally do well in all parts of the state where coldwater ponds exist. Rainbow trout grow best when the water is between 54-66°C (12-19°C). They commonly reach a size of 15 inches (38 cm) in about three years. Few usually live long enough in a pond to reach 20 inches (50 cm).

Brook Trout (*Salvelinus fontinalis*)

Brook trout are also very suitable for Michigan coldwater ponds, but for best growth they need water of 48-60°F (9-16°C), which is cooler than for rainbow trout. Therefore,

brook trout are more widely used in northern than in southern Michigan. Brook trout are also easy to catch and can provide especially tasty table fare. They may grow as well as rainbow trout up to a size of 10 inches (25 cm), after which their growth is slower. A 15-inch (38-cm) brook trout is an exceptionally large one, but a few of 18 inches (46 cm) or longer occur in Michigan ponds. For fishing variety, rainbow trout may be stocked together with brook trout.

Brown Trout (*Salmo trutta*)

Brown trout are less desirable in ponds because they are relatively hard to catch. While this may furnish a welcome challenge to skilled anglers, it disappoints many people, and a stocking of brown trout usually produces a far lower total harvest over the years than does a stocking of rainbow or brook trout. They can live 5-7 years, despite heavy fishing, even by skilled anglers. Trout over 18-20 inches (46-50 cm) can be very cannibalistic which may render further stocking with fingerling or yearling trout infeasible—unless the large brown trout are removed. This may require use of fish toxicants.

Hybrid Trout

Hybrids between various kinds of

trout are sometimes available and can be interesting to use. They are unusual and often grow faster than purebred trout, but may be hard to catch. They usually aren't practical for the pond owner who is simply interested in recreation and a few fish on the table.

Warmwater Fishes

The primary warmwater fishes used in Michigan ponds are members of the sunfish or bass family: the predatory largemouth and smallmouth basses and the smaller sunfishes, such as bluegills, pumpkinseeds, and green sunfish. Another commonly used warmwater fish is the channel catfish. Various minnows of use in ponds could also be classed as warmwater fishes, but we will discuss them later under the heading of forage fishes.

Largemouth Bass (*Micropterus salmoides*)

Largemouth bass are stocked in most of Michigan's warmwater ponds. They adapt to a wide range of pond conditions, can grow to large size, and are a very popular game fish. Their growth in Michigan varies, depending on food supply, competition with other fishes, and water temperature. They grow

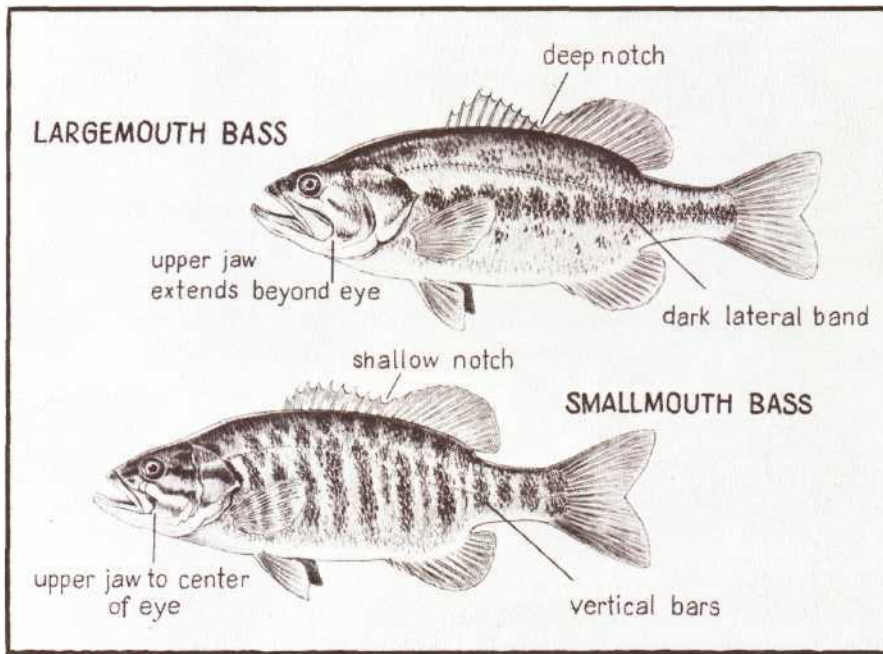

Largemouth and smallmouth bass. The latter is especially suitable where water temperature is a bit too cool for largemouth bass but too warm for trout.

fastest when the water is above 75 °F (24 °C). Although largemouth bass may live for 10 years, the average pond has very few older than 5 years.

Young bass eat water fleas, insects, and very small fish and crayfish. Adults prey on almost any available animal that fits in their mouth, such as fish (including their own offspring), crayfish, tadpoles, frogs, worms and insects. In Michigan, it's best to stock minnows as forage for largemouth bass. The bass prefer them by far to bluegills and other panfish.

Most female largemouth bass first spawn when 2-4 years old, or about 10 inches (25 cm) long in Michigan ponds. Spawning occurs in May or June when the water is between 60° and 75 °C (15-24 °C). To form a nest, the male sweeps a shallow circular depression in sand or organic bottom at a water depth of 2-6 feet (60-180 cm) and usually near hiding cover. He fertilizes the eggs as the female scatters them on the nest, and he guards them and the newly hatched fry until they leave the nest in a school. Numbers of largemouth fry hatched per nest vary considerably. An average of 4,375 was found in one Michigan study. Less than one percent of the eggs carried by each female will usually survive until the first autumn.

Survival may be reduced by sudden drops in water temperature, by predation on eggs and fry (particularly that of bluegills and other sunfish), and by competition for food with other fishes.

Smallmouth Bass (*Micropterus dolomieu*)

The smallmouth bass, another large member of the sunfish family, is suitable for ponds that have clean gravel beds for spawning and somewhat cooler water than is best for largemouth bass. For these reasons, old gravel pit ponds often furnish excellent smallmouth bass fishing. Smallmouths are sometimes classified as a "coolwater" fish rather than in the warmwater group. Many anglers like smallmouth bass better than largemouth because they fight harder. Their feeding, growth, reproductive habits, and management are roughly similar to those of largemouth bass.

Bluegill (*Lepomis macrochirus*)

The bluegill is probably the fish that is most frequently stocked in warmwater ponds, but it is often unsatisfactory in Michigan because of stunting. Pond owners who wish to stock bluegills should be cautioned that, although several years of good fishing will probably follow the initial stocking, intensive management

is required to maintain desirable body growth. This is because bluegills breed prolifically, overpopulate the pond, and severely overgraze the food supply, whereupon growth decreases. Despite stunted body size, they remain prolific.

Bluegills feed on a wide variety of organisms, including insects, water fleas, fish eggs, and very small fish. Some rooted aquatic plants and algae are also eaten.

Growth varies, depending largely on how crowded the bluegills are. Under favorable conditions, they reach 6 inches (15 cm) in 2-3 years but in many ponds, they reach this size only after 4-6 years.

In Michigan, female bluegills reach sexual maturity by the second to fourth summer of life and produce 6,000 to 27,000 eggs per year, depending on body size. Bluegills spawn over almost any type of bottom in water 1 to 3 feet (30-90 cm) deep, starting in May or June. As with bass, the male bluegill builds and guards the nest. Nests are usually 6-12 inches (15-30 cm) in diameter and close together. The average nest contains about 18,000 fry which may be from more than one female.

Bluegills have a long spawning season, generally lasting from late May to August. Females ripen at different times, and the eggs from a single fish mature gradually. A

female may deposit eggs in batches over a several-week period. The long spawning season assures that there will be offspring even if adverse conditions occur during some parts of it.

The bluegill does have some desirable qualities: It is easily caught, is a good scrapper on light tackle, and is tasty. It's ideal where you want fast action for kids.

Hybrid Sunfish

Bluegill-pumpkinseed hybrids and other crosses between sunfish species are infertile and therefore are desired by some pond owners as substitutes for bluegills (and any of the other sunfishes) which overpopulate. However, hybrids are often unavailable from dealers, they tend to be expensive, and commercial stocks of hybrids often are contaminated with fertile sunfish. The result is breeding, eventual overpopulation, and stunting. The prospective buyer should weigh the potential harm of this risk against purported benefits. The only benefit may be a forestalling of overpopulation by a year or two.

Channel Catfish (*Ictalurus punctatus*)

Catfish stocking in Michigan ponds has increased, owing to their greater availability since extensive southern catfish farming developed in the 1960's. But the catfish has certain drawbacks in ponds of northern states. They do not generally spawn successfully in ponds unless special spawning structures are installed. Also, their growth in Michigan is slow compared to growth in the South. The catfish is a truly warmwater fish which grows fastest in water over 80°F (27°C). In fact, catfish farming is possible only in southern states or where the water exceeds 70°F (21°C) for at least 4 months each year.

Nevertheless, catfish gradually grow large enough to provide recreational fishing in many southern Michigan ponds. They normally reach 12 inches (30 cm) after 3-4 years.

Catfish eat many types of food, both living and dead: insect larvae, crayfish, snails, worms, clams, fish

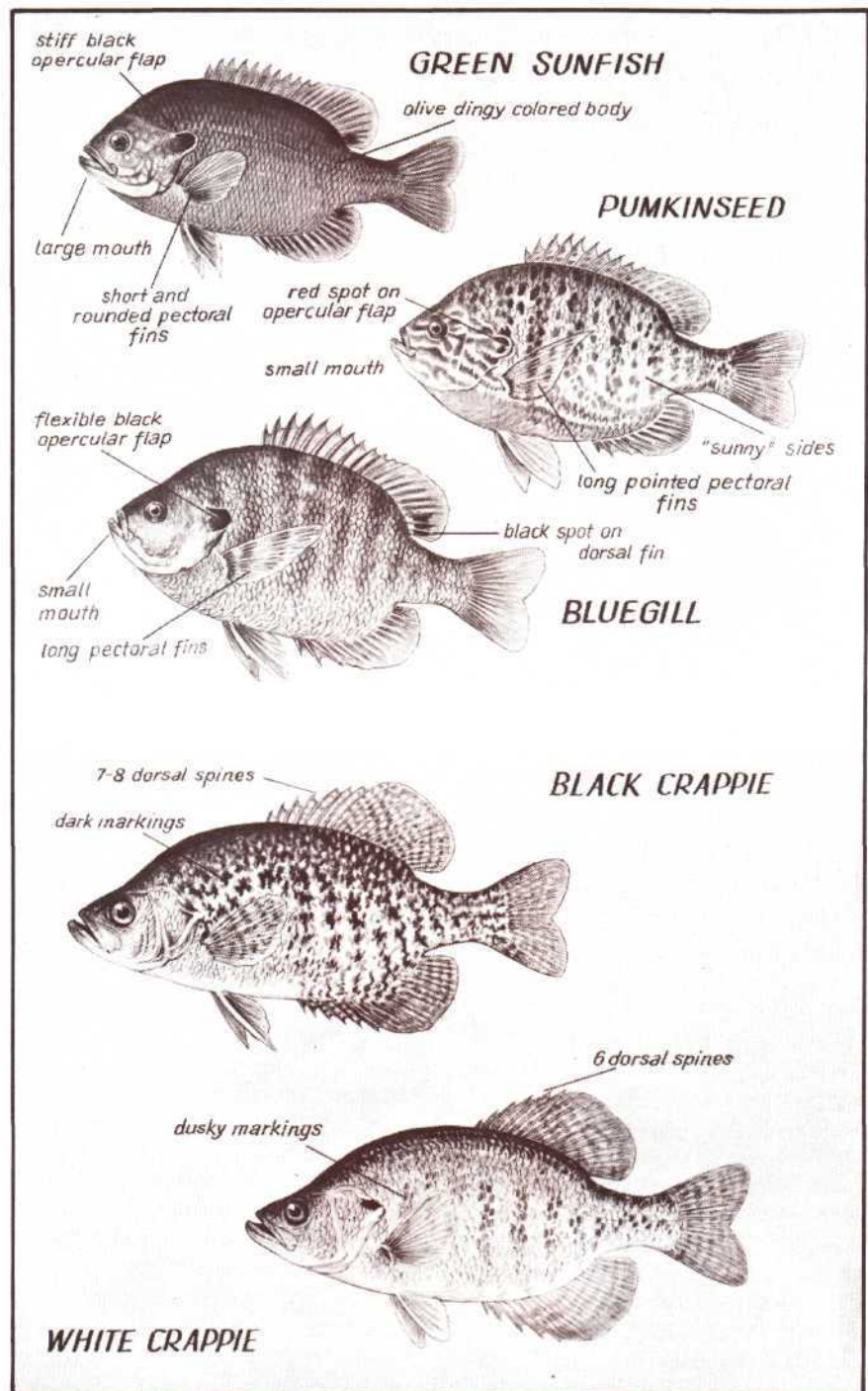

Panfishes — these generally are unsatisfactory in Michigan ponds.

and various items which fall into the pond.

Females usually mature at 13-16 inches (32-40 cm) in length. They spawn in a cavity such as beneath undercut banks or in hollow logs when water reaches 75°F (24°C). The male guards the eggs and fry until they school and leave the cavity.

Forage Fishes

Small fishes, such as minnows and shiners, can be stocked in ponds to provide forage for bass and catfish, although it will not always be necessary to do so. **NEVER STOCK FORAGE FISH FOR TROUT.** Trout don't need them, and the small fishes will compete for the food that the trout do eat.

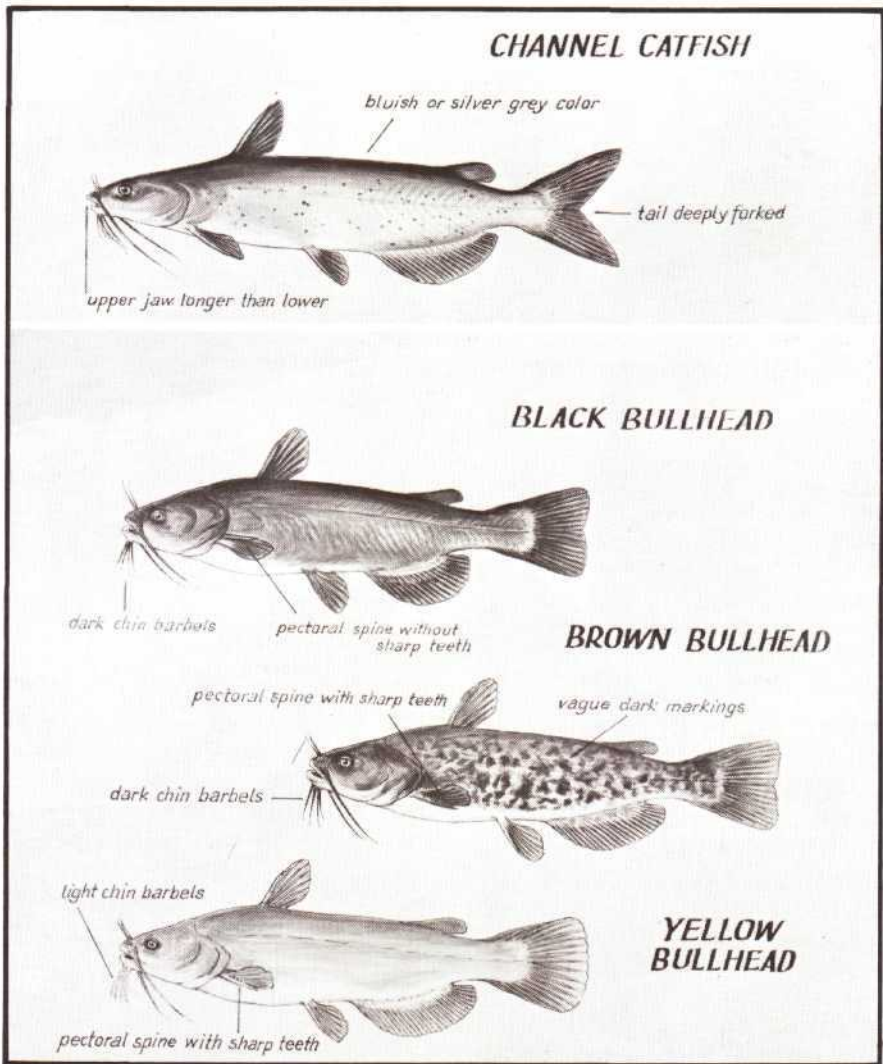

Channel catfish and bullheads.

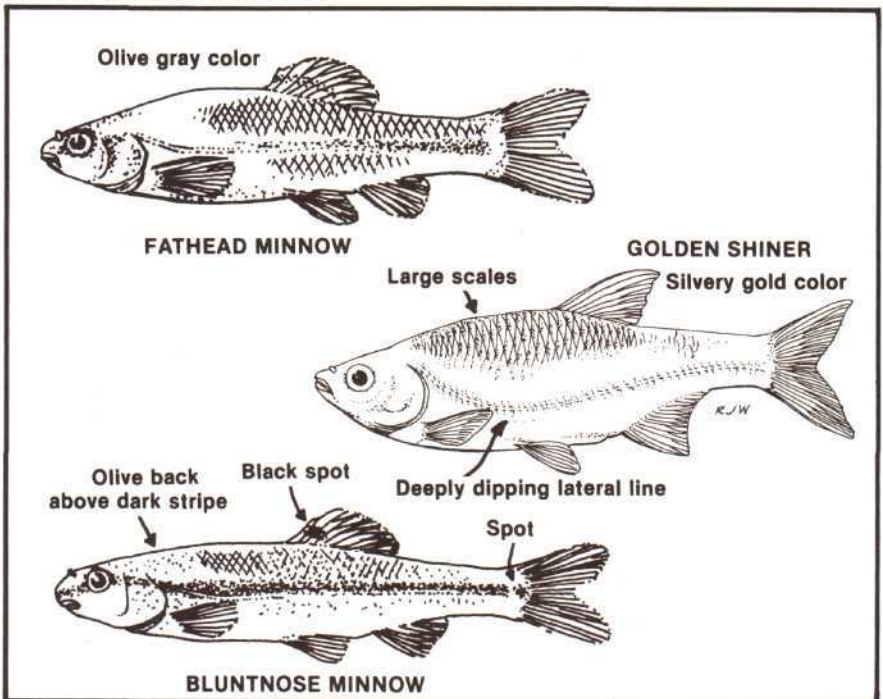

The most suitable bass forage fishes in Michigan are the fathead minnow (*Pimephales promelas*) and the bluntnose minnow (*P. notatus*). The golden shiner (*Notemigonus crysoleucas*) can often also be used with success. These all feed on plankton and insects and will reproduce in Michigan ponds if there is suitable spawning habitat.

Bluntnose minnows seldom exceed 4 inches (10 cm), and fatheads 3 inches (7.5 cm). Golden shiners attain a maximum length of about 10 inches, and if many in the pond reach 6 inches (15 cm) or larger, this may create competition for the food of young bass. This is a disadvantage of golden shiners, and for this reason, fathead minnows are usually preferable as bass forage.

All 3 species will spawn when 2-3 inches long and normally several times throughout spring and summer. Spawning starts when the water warms to 65°F (18.5°C) in areas which are 1-2 feet (30-60 cm) deep. Golden shiners deposit their eggs on aquatic plants. Fathead and bluntnose minnows lay eggs on the underside of rocks, tile, boards or logs. Adult fatheads usually die shortly after spawning.

Fishes Not Recommended for Pond Management

Some fish are undesirable for stocking in Michigan ponds if many years of quality fishing is the goal. Bluegills may be put in this category (see page 25 and also chapter 7 for more detailed discussion). These and others may enter ponds during floods or through pond outlets from nearby waters.

Trespassers, such as well-meaning neighborhood kids, are notoriously fond of stocking fish from nearby ditches, streams and lakes. Pond owners should learn to readily iden-

Forage fishes for bass or catfish in Michigan ponds. NEVER stock minnows or other forage fishes in trout ponds!

tify the following undesirable fish and try to keep them out of their ponds for the following reasons:

Crappie (*Pomoxis* spp.), **Yellow Perch** (*Perca flavescens*), **Green Sunfish** (*Lepomis cyanellus*), and **Bullheads** (*Ictalurus melas, natalis* and *nebulosus*)

These fish, like bluegills, tend to overpopulate the pond and become stunted. They compete with and prey upon the eggs of other gamefish, particularly bass.

Carp (*Cyprinus carpio*), and **Suckers** (*Catostomus* spp. and others)

These also compete with gamefish for food and prey on their eggs. They are bottom feeders which roil the water, hampering sight-feeding by gamefish.

Northern Pike, (*Esox lucius*), **Walleye** (*Stizostedion vitreum vitreum*), and **Muskellunge** (*Esox masquinongy*)

Although survival is certain in most ponds, these "coolwater" fishes won't reproduce and are very expensive to purchase. They often prey heavily on bass and catfish, but not effectively enough on stunted panfish populations to remedy such problems.

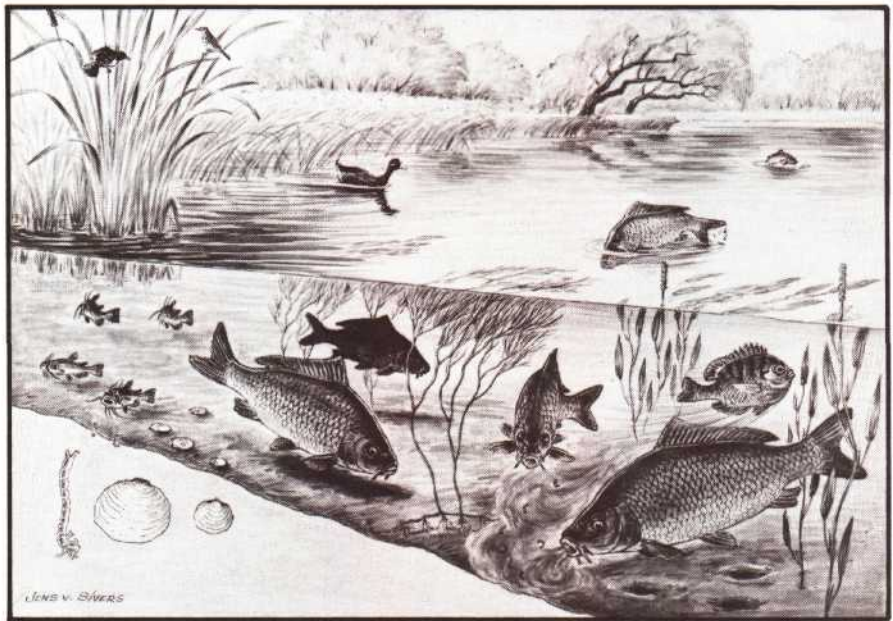

Some of the fishes usually best kept out of ponds.

Exotics

Many species of fish exist in the world which are not native to Michigan and most would not survive in the wild here. However, certain species have the potential not only to survive here, but to reproduce. When this occurs, they become a nuisance and compete unfavorably with native fishes. The common carp is the best example of an introduced exotic which has had

adverse effects on some native fish populations. The grass carp (white amur), Japanese weatherfish, ide, rudd, bitterling and tench are other exotics which could become established in Michigan waters and compete with native fish for food and living space. For this reason, eggs of fish of these species may not be imported.

How and Where To Get Fish For Stocking

There are two ways to obtain fish for your warmwater pond—purchase them from a licensed game fish breeder (live fish dealer), or catch them and plant them yourself. Obtaining them from a licensed game fish breeder is easiest, most economical and safest in the long run because you can get them at just about any time and in the number needed. A list of Michigan licensed game fish breeders is available at no cost from DNR District offices (Appendix), or any of the county SCS field offices.

If you choose to catch your own fish to stock your pond, be sure they are free of unwanted parasites and in good condition. The stress from catching the

fish, holding them in a cooler or on a stringer, and transporting them to your pond could make the fish unsuitable for stocking. You might obtain them from someone else's pond or from public waters. In the latter case, you must adhere to all state fishing laws. This means you must have a fishing license and abide by the regulations governing season, bag limits and size limits. For these and other regulations, especially those governing the use of seines and nets, consult the "Michigan Fishing Guide," the DNR's annual statement of regulations, available where licenses are sold.



Managing Warmwater Ponds For Fishing

Determining If a Pond Is Suitable for Warmwater Fish

For warmwater fish, much of the pond should be warmer than 70°F (21°C) for most of the summer. If cooler, it may be better for trout (Chapter 8).

Measure water temperature on a hot summer afternoon a foot below surface near pond center. If over 70°F, it's probably suited for warmwater fish. This is just a rough guide. Warmwater fish grow best at 75°F (24°C) or more.

In case of borderline temperatures, there are three alternatives to consider:

- Try trout. Often they do well in a borderline pond for several years until dissolved oxygen content of the water falls too low (under about 5 parts per million) due to accumulation of organic matter.
- Try smallmouth bass (with or without minnows). They prefer somewhat cooler water than do largemouth bass and other warmwater fishes.
- Try largemouth bass.

Try trout only before any other kind of fish is stocked. This will avoid competition from residual bass or minnows. In borderline cases you can economize by using only a token stocking of a dozen or so fish per acre, then follow their progress by catch-and-release fishing. If they survive and grow well the first year, stock more.

For warmwater fish, summer dissolved oxygen can be as low as about 3-4 parts per million, but should be higher than 5 ppm most

of the time. Oxygen will be more plentiful in summer and winter if water depth is at least 15 feet (5 meters) and plant nutrients low to moderate, so excessive build-up of organic matter doesn't occur.

For more information, see Chapter 4, "Ponds as Places for Fish to Live."

Stocking

While stocking is far from being the only important aspect of managing for good fishing, the kind of fish used, their body size, amount stocked, and time of stocking will do much to determine fishing quality, especially in the first 3-5 years after a pond is built or renovated. Special details on stocking of various kinds and combinations of fish are given below. For other information on each kind of fish see Chapter 5. Chapter 9 deals with fish population control.

Largemouth bass, bluegills and other panfish usually won't need restocking, since they reproduce well in most ponds. Adding to established populations of these fishes generally results in loss of the newly-stocked fish—or to competition and poor growth of survivors. Smallmouth bass may have to be restocked, and channel catfish usually will.

Bass (largemouth or smallmouth) without other fish. In ponds lacking other fishes which compete for food, bass often thrive on worms, insect larvae and crayfish. We strongly recommend trying bass alone. If growth is unsatisfactory, forage fish can always be added. Smallmouth will work better than largemouth bass where the water is



on the cool side. They may also do better than largemouth bass in new or renovated ponds that haven't yet developed much forage. Smallmouths often don't spawn successfully, because they need gravel and the young require more dissolved oxygen than largemouth fry.

Bass with forage minnows. Stock minnows before the bass or wait to see if they're really needed. **Fathead minnows** are generally best, since they don't grow larger than 3 inches. **Bluntnose minnows** can also be used. **Golden shiners** usually work well, but sometimes grow too big for bass to eat, if large bass aren't maintained in the pond as recommended in this bulletin. Should golden shiners become too large, they compete with bass for food. If the bass deplete the minnow population in a few years, simply stock more, scattering well to reduce immediate predation. A moderate amount of rooted plants in the pond gives minnows some shelter from bass and allows enough to survive and reproduce for an ongoing population. Installing tile pipes or raised "spawning boards" may also aid minnow reproduction.

Channel catfish and minnows. Channel catfish grow slowly and seldom reproduce in Michigan ponds. They usually must be restocked for continued fishing. If shelters such as milk cans, kegs, or closed pipe are provided, they may occasionally breed. Use the same kinds of minnows as for bass forage.

Sometimes, for variety, channel catfish are added to a pond having bass and/or panfish. If adult bass are present, use catfish larger than 7 inches (17 cm) to minimize predation. Bass and panfish will prey on any catfish fry produced.

Largemouth bass and bluegills. BEWARE of this combination! It's a favorite in the South, where it can work, but it has been oversold in the North. Bass are supposed to control bluegills by predation, but it doesn't work that way in our climate. The bluegills overpopulate the pond, and then both bass and bluegills have stunted growth. If you want bass and bluegills anyway, give the bass 1-2 years head start in growth

Table 7.1. Stocking guide for Michigan warmwater ponds to achieve maximum growth without supplemental feeding and aeration.

Kind of fish	Number to stock per surface acre	Length (inches)	Time of year
Largemouth or smallmouth bass alone	*100 fingerlings OR 25-50 yearlings OR 6-8 adults (both sexes)	2-4 6-10 12+	July-August April-October October OR May
Bass with minnows	500 adult minnows, then, after minnows spawn, stock bass as above	2-3	April-May
Channel catfish with minnows	500 adult minnows, then, after minnows spawn *100 fingerling catfish	2-3 2-4	April-May July-August
Largemouth** bass with bluegills	Stock bass as above, then, after 1 or 2 years 500 fingerling bluegills	1-2	July-August
Bluegill or other panfish with NO bass	500 fingerlings THIS ALTERNATIVE IS NOT RECOMMENDED!	1-2	July-August
Hybrid sunfish	400-800 fingerlings	1-3	July-October

*Reduce by half if water alkalinity under 50 ppm.

**Don't use smallmouth bass, as they eat very few bluegills.

and spawning. Then they may have more effect on the bluegills.

Bluegills or other panfish without bass. This results in overpopulation and stunting even sooner than with the bass-bluegill combination. If a bluegill-only pond is desired, consider stocking only fingerlings. This delays the onset of stunting by giving the initial population some time to grow before they have offspring which will then compete with them for food.

Hybrid sunfish with or without bass. Artificial crosses between various species of sunfish (bluegill, green sunfish, pumpkinseed, etc.) may have advantages of hybrid vigor and sexual infertility. This makes them fast-growing and manageable. Without reproduction, food supply and room to grow are maintained, and the energy of the fish goes into body growth rather than into producing eggs and milt and carrying on the intense activity of spawning. However, beware—**purebred** sunfish are almost always among the hybrid fingerlings stocked. These purebreds mature, spawn and start the pond on its way to overpopulation. Still, the number of fertile "mistakes" is usually so low

that the onset of crowding is delayed for several years—with excellent fishing for panfish in the meantime. Sunfish hybrids have been expensive and hard to get. If you pay for hybrids, get a legally binding guarantee that they are genuine. **Hybrids are of little or no value when stocked in presence of existing panfish populations.**

Exotic fishes. Fishes not native to Michigan are sometimes desired by pond owners. Most of these, such as grass carp, tench and Japanese weatherfish, are inadvisable and illegal. See discussion in Chapter 5.

Angling Harvest

Bass

The harvest of bass should be delayed until they have spawned once. This insures that they will become well established before other fishes (especially panfish) disrupt the food supply. It may mean waiting 2-3 years if you stock fingerlings, 1-2 years if you stock yearlings, or until the next mid-June if you stock adults.

If you stock 100 bass fingerlings per acre, expect to have 25-30 adults per acre after 2 full summers in the

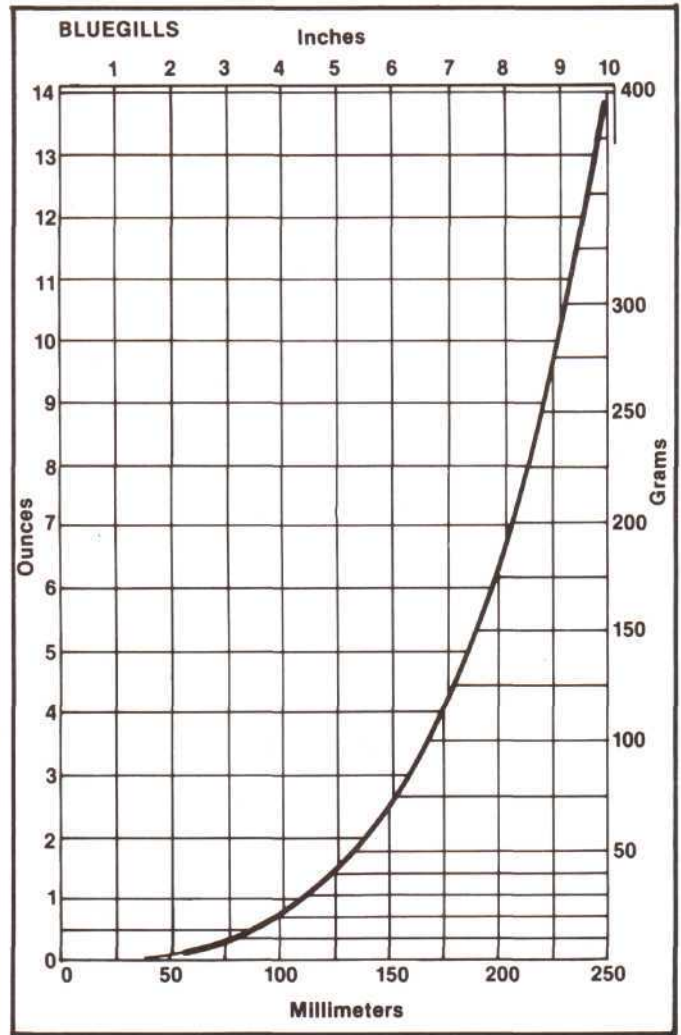
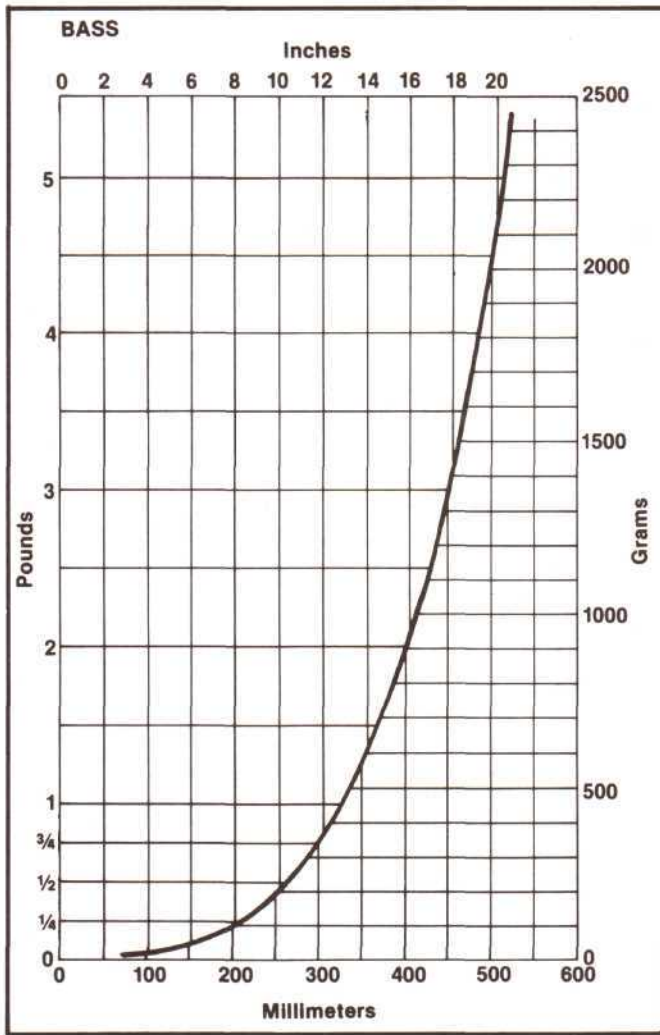

pond. The original bass stocked as fingerlings must support the first 5 years or more of the pond's bass fishing. Therefore, harvest them lightly!

Light harvest means not removing more than 20-25 pounds of bass per acre each year. Record length and weight of all fish taken from the pond. (Recording information about caught-and-released fish also can be useful.) After the year's quota has been taken, release all further bass caught.

There are many ways to manage harvest in an established Michigan bass pond, especially if panfish have also been stocked. Since panfish can easily overpopulate and stunt in Michigan ponds, it is important to protect the sizes of bass that are effective panfish predators. Bass 12 to 16 inches (30-46cm) are effective predators on 3-5 inch (8-13cm) panfish like the bluegill.

The easiest way to insure that these panfish predators are available is to release all 12-16 inch bass. Once the pond contains a healthy population of this size bass, you can harvest a few 10-12 inch bass (25-30cm) and those over 16 inches. Harvesting some of the 10-12 inch bass will help select for the fastest growing fish. Since slower growing fish will be 10-12 inches for a longer time than the faster growing fish, they will be more likely caught than the faster growing fishes.

At any time that bass of a certain size appear thin and poorly-fed, harvest bass of that size more heavily. If a bass weighs less than 95% of the standard weight for its length, it is too thin. Use the graph on this page to check whether your bass are of standard weight.

Channel Catfish

If you stock channel catfish as

Determining whether a bass or bluegill is of proper weight for its length. Weigh the fish to the nearest half ounce or 10 grams, if less than ¼ pound. If heavier, it may be weighed a bit less precisely. Measure length to the nearest eighth inch or millimeter. Plot weight on the vertical scale and length on the horizontal scale. Draw a horizontal line lightly with pencil at the fish's weight and a vertical line at its length. If the point where the two lines intersect is on the heavy curved line, the fish is of standard (or average) weight for its length. If the point lies above the curve, it is heavier than average. If it lies below the curve, the fish is underweight.

fingerlings, start harvesting them in the second or third year after stocking when they have reached 9 to 10 inches. If the catfish population is one of those rare ones in Michigan that can sustain itself by natural reproduction, remove only 10-15 fish per acre each year. Usually, however, replenishment will be by annual restocking, and all fish caught above whatever size pleases the owner can be harvested.

Bluegills and Other Panfish

Start harvesting as soon as they are a size you like. In new ponds or ones where fish have been eradicated, some bluegills stocked as fingerlings should exceed 4 inches the next summer and 6 inches the summer after that.

Follow two harvest rules: (1) Remove as many under-6-inchers as you can. (2) Greatly restrict harvest of over-6-inchers. This works against overcrowding and helps superior brood stock survive. Just as with bass, the biggest, fastest growing bluegills bite most readily and tend to be caught first.

The table on page 33 indicates lengths bluegills should reach at each age. The graph on page 33 shows how much bluegills should weigh at each length. If the bluegills are growing too slowly or are thin, it is an indication of overcrowding.

The Bass-Bluegill Combination

Follow the procedures outlined in the above sections on bass and on bluegills. Harvest at least 4 pounds of bluegills for each pound of bass harvested. This helps bass keep the upper hand longer. It is especially important to restrict harvest of over-15-inch (43 cm) bass. At that length, they may be nearly 2 pounds and are probably just beginning to eat enough bluegills to have much effect in controlling their population. Have fun catching large bass and releasing them alive. Try to

build up a substantial population of bass weighing 3, 4, and 5 pounds.

No matter how intensively you manage the bass-bluegill pond, the day will probably come when the bluegills simply take over. Bass spawning success will decline, large bass and bluegills will disappear, and there will be hordes of small bluegills—all about the same size. When this occurs, the owner is often tempted to plant more and bigger fish—maybe even walleye or northern pike. Resist such impulses! Walleye and northern pike are not suited to life in small warmwater ponds (Chapter 5), and the only cure for stunted panfish is a sound program of population control (Chapter 9).

Higher Stocking Levels and Fish Feeding Not Recommended

Higher stocking levels may lead to the fish outstripping the natural food supply. Although many fish will eat pelleted fish feeds, it is usually best for pond health, appearance and your pocketbook to manage so that the fish are sustained by the food that occurs naturally in the pond. Adding pellets, bread or other fish food may increase fish growth in an overcrowded pond—but it will probably also accelerate growth of algae and other aquatic plants to excessive amounts. The result may be not only unsightly and interfere with fishing, but build-up of organic matter in the pond may cause oxygen depletion and die-off of fish.

Pond Fertilization and Liming

Fertilizing and liming are generally **not** recommended for Michigan sport-fishing ponds. Although often advised in the soft water ponds in the Deep South to increase algae growth to

enhance the food chain, fertilization here usually causes excessive weed and algae growth. The result is plant control problems (Chapter 10), dissolved oxygen shortage for fish due to rotting of accumulated organic matter, and eventual stress or even death of fish.

NEVER use fertilizer for creating algal growth to stifle rooted plants, as is done in the South. Such enrichment is so strong as to run grave risk of causing winterkill of fish.

Liming is sometimes used to raise alkalinity of the water to counteract acidity problems or to allow the pond to handle phosphorus fertility in ways that boost production of fish rather than of bluegreen algae nuisances (Chapter 4).

Fertilizing and liming of ponds should be done only under direction of a water chemistry expert who understands proper balance between alkalinity and phosphorus content and who can determine the right dosage of phosphorus or lime.

Emergency Aeration of the Pond

In Chapters 8 and 10 are described ways to inject a stream of air bubbles at the deepest part of the pond to circulate the water and keep sufficient dissolved oxygen in the deep zone. Such aeration is sometimes used in aquatic plant control and, in an emergency, can be used to rescue fish from a temporary crisis of diminishing dissolved oxygen content, such as on especially hot summer nights or during an especially hard winter. Aerators are particularly useful in preventing winterkill of fish. The circulation achieved by the bubble stream maintains an open area of ice-free water through which the pond can take on oxygen. However, an aerator should not be needed in a properly designed pond.

Managing Coldwater Ponds For Fishing

General Considerations

The usual way of managing cold-water fish ponds involves the following steps:

1. Stock small trout.
2. Fish for them when they grow to desirable size.
3. Restock as the population diminishes.

Restocking is usually done annually. The interval can be greater if little fishing is done and the trout survive other hazards well. Annual stocking with fingerlings or yearlings is often desired because it creates an interesting population with several year classes and a variety of sizes present. Keep in mind that trout reproduce in few ponds, so replenishment of the population usually depends on stocking. See Chapter 5 for information about the different kinds of trout.

Trout don't thrive when there are other kinds of fish in the pond. Bass, pike and catfish will eat large numbers of trout. Panfish, bullheads, suckers, carp and even the smallest kinds of minnows compete for the main types of food that trout need. When competitor fishes are in a pond, trout growth is poor.

The common idea that trout need small fish as food is mistaken. They usually grow better on invertebrates such as water fleas, insect larvae and crayfish. **KEEP MINNOWS OUT!**

Where to obtain trout for stocking is discussed in Chapter 6.

Determining If a Pond Can Support Trout

Trout need water that is cool and rather rich in dissolved oxygen. The rule of thumb is that water temperature a foot below the surface should

seldom exceed 70°F (21°C) and that dissolved oxygen should rarely fall below 5 parts per million. Dissolved oxygen content of 7-8 ppm is most favorable. Some ponds where the upper water is a little over 80°F (27°C) for a few hours on some days support trout because there is enough deep, cool, well-oxygenated water.

Much depends on pond depth and water supply. As a rule, the deeper, the better. Although trout can often do well in only 6-9 feet (2-3 meters) of water, if there is very strong spring flow, they usually survive and grow even better if that same pond is deepened. For best results, have it deeper than 15 feet (5 meters). See Chapters 3 and 4 for more information on pond depth considerations.

A practical way to find out if a pond can support trout is to simply plant a few. If the pond was properly designed and built there probably isn't much to worry about. But, if there is some doubt, and you don't want to risk the expense of fully stocking the pond, stock a token number of 5-to-8 inch (13-20-cm) trout in springtime or fall. Then, do some test fishing to check on growth and survival over one full year. For a trial program, stock at least 10 fish per acre—in no case less than 20 per pond. If the trout survive both summer and winter, this shows that the pond can support trout.

During the trial period, you may want to keep records of temperature and dissolved oxygen in the pond. This information may warn of deteriorating conditions and provide an explanation if fish do not survive. See Chapter 4 for temperature and oxygen measurement procedures.



Some ponds on the borderline between coldwater and warmwater conditions can support trout only for a few years. As vegetation develops, dead organic matter accumulates and consumes more oxygen. Temperatures may also increase. A decreasing water supply, as during drouth, can aggravate this situation. Such a marginal pond can be managed for trout until the unfavorable conditions develop. Then bass or other warmwater fishes can be stocked.

Stocking

Preparing the Pond for Stocking

A new pond, properly built (Chapter 3) for coldwater fish, usually needs no further preparation. In converting an old pond to support trout or readying a renovated trout pond, certain actions may be needed before stocking.

If other kinds of fish are in the pond, they must be completely removed (Chapter 9).

Screen inlets and outlets to prevent entry of the smallest fish. Maintaining screens can be quite a problem, so it is far better to build the pond without connections to other waters which would harbor fish. Caution children and friends not to bring in minnows, panfish, goldfish or any other fish!

You may at this time want to combine a re-digging operation with a fish-removal drawdown. Dragline digging with the pond bed exposed and somewhat dry may be much cheaper than suction dredging or drag-lining when the pond is full.

Even if you don't dig the pond deeper during a drawdown, take advantage of the situation to rake out aquatic plants and debris. Reducing organic matter will usually improve a pond for trout. See Chapter 10 for plant control methods.

When to Stock

April, May, and possibly June are good trout stocking months because water temperatures have warmed considerably but are still moderate, and natural food organisms are increasing in abundance. Fish planted at this time tend to survive better and start growing sooner.

Table 8-1. A guide for stocking trout to achieve maximum growth without additional feeding and aeration.

Type of trout	Size in inches	Number* to stock per acre	Time to stock	Comments
Spring fingerlings	2-3	200-300	April-May	Cost least. May be hard to get. Use ONLY FOR INITIAL STOCKING of new pond or one which has had all fish removed.
Fall fingerlings	5-6	50-150	Sept-Oct	For initial stocking or restocking.
Spring yearlings	6-7	50-150	April-June	For initial stocking or restocking. More expensive than fingerlings.
"Adults"	over 7	25-50	spring or fall	For initial stocking or restocking. Can be very expensive.

*The lower number is for ponds with alkalinity less than 50 ppm or which will be lightly fished. The higher number is for ponds with alkalinity over 150 ppm and/or which will be heavily fished, hence be more rapidly "thinned out."

Trout can also be stocked in September and October when the pond is becoming cooler. However, there is less chance for growth because the pond soon becomes too cold. Fall stocking is usually done only in new or redredged ponds—or where the fish have been eradicated during summer. Except in unusually good ponds, many fall-stocked trout may die during harsh winter conditions. The losses may be outweighed by much lower cost of fall fingerlings. Also, the longer time that fall-stocked fish are on natural feed before the fishing season often results in better appearance and flavor than newly-stocked fish.

Stocking trout in summer is inadvisable due to risk of thermal shock which can kill many or all of the fish planted.

Number and Size of Trout to Stock

Table 8-1 is a guide to achieving trout populations which grow well on natural food supplies. **ONLY ONE** of the types listed should be stocked in one year, although "adult" trout can be restocked as often as they are fished out.

A common mistake is to stock too many trout—which results in poor growth. The stocking rates recommended are conservative and are lower than often suggested in the past. We believe it far better to risk starting with too few trout than to risk ruining the food supply. If the trout are fast-growing (see diagram,

page 37) and stay plump all year, then stocking can be done at a somewhat higher rate the next time.

The number and size of trout to stock depend on conditions of the **individual** pond: amount and size of trout already present, how fast they are to be harvested, the food supply, and whether there is natural reproduction. Adjust stocking from year to year according to past experience and current conditions.

Infertile ponds may support only about 20-25 pounds of trout per acre. Very fertile ponds may sustain upwards of 150 pounds per acre on the natural food supply.

Pond capacity for trout production can be increased several fold by artificial feeding, and then the stocking rate can be raised. However, feeding can cause various problems (page 38).

As a rule, the larger the body size of the trout stocked, the greater the percentage that survive to be caught—and, of course, the sooner there will be fishing for big trout. Whenever you stock, consider using the largest fish that the pocketbook allows. Price per stocked fish rises sharply with increasing size, but the number needed to adequately stock the pond decreases.

Experimenting in the pond over the years should reveal the best sizes and numbers to stock. Keep careful records of fish stocked and of fish caught. Calculate the **cost per pound caught**—or per fish of desirable size caught. You may find that

these costs decrease if you raise the size of fish stocked somewhat beyond the smallest, cheapest fish available.

For the first stocking of a new or renovated trout pond, it may be most economical to use spring fingerlings. Plan not to fish them until the next spring when they should be 7-8 inches (17-20 cm) long. However, you may want to do some test fishing in the interim.

If you want an initial springtime stocking to provide more immediate fishing, use yearlings of 6-7 inches. In excellent ponds, they will grow an inch a month during spring, summer and fall.

For restocking in ponds with established trout populations, don't use fish smaller than fall fingerlings (5-6 inches or 12-15 cm). If larger fish are used, there will be fewer losses to cannibalism by trout which have survived from previous stocking. Annual restocking may provide far more consistent fishing than restocking at greater intervals.

Transporting and Planting the Trout

Contact the state fishery office nearest to your pond (see Appendix) to see whether a permit for stocking is required. One will be needed if the pond has any connection with other waters or if certain other conditions apply. Allow at least a month for the inspection and permit issuance.

Be sure the trout are healthy when stocked. Don't accept fish that are obviously diseased or that appear weak or abnormal in behavior. Fish stressed by improper handling and transport will die soon after stocking. Even under the best conditions, 10-20 percent of them may die in the first 2-4 weeks.

If you transport your own fish, keep the water at a rather constant low temperature (50-60°F or 10-15°C). Handling stress is greatly reduced in cool weather.

Besides being cold, the water must be well-oxygenated and **unchlorinated**. There are small aeration devices that operate on batteries or automobile current—or you can attach a tube with clamp-valve and airstone to a spare tire.

Cool the container of water (plastic trash cans work well) with ice. It's usually most convenient and reliable to let the dealer deliver the fish.

As mentioned, stocking trout in summer is inadvisable. Since trout must be transported in water that is much colder than the summer surface water of most ponds, they may undergo lethal stress in passing through the warm upper layers of the pond toward the cool water below. Resulting deaths may not be evident immediately, but may take several hours or days to occur.

If more than a 10°F (5°C) difference exists between transport water and the pond, "temper" the trout to the new water gradually. To do this, add small amounts of pond water to the transport tank until its water is of pond temperature. If the fish are transported in plastic bags, trash cans or other small containers, these can be set in the pond until the water inside is the same temperature as the pond.

CAUTION: If the transport bags have been filled with oxygen and tied off, do not open the bag (unless fish are in distress) until tempering has been accomplished and you are ready to release the fish into the pond.

Flushing the trout through a large tube from the transport truck directly into the cold pond depths is another way to reduce thermal shock losses, but few dealers have such equipment. All in all, it is best not to stock in summer.

When to Start Fishing and How Much to Harvest

Do some catch-and-release fishing periodically to see how the trout are growing. Start keeping them as soon as you start catching some of desirable size. Reasonable size at which to start harvest is 7-10 inches. If you delay harvest until they are much larger, the total return may be severely reduced. This is because loss of fish by non-fishing or "natural" causes is usually rapid, especially in the case of rainbow or brook trout. Few live to be over 3 years old, and at some point before

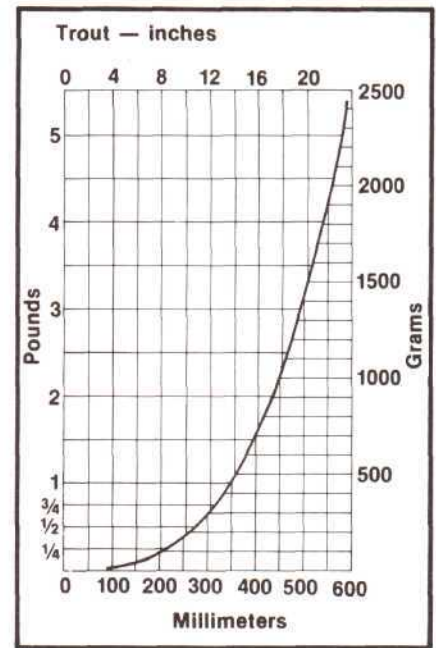

Determining whether a trout is of proper weight for its length. Weigh the fish to the nearest half ounce or 10 grams, if less than ¼ pound. If heavier, it may be weighed a bit less precisely. Measure length to the nearest eighth inch or millimeter. Plot length on the horizontal scale and lightly pencil a vertical line there. Plot weight on the vertical scale and draw a light horizontal line there. If the point where the two lines intersect lies on the heavy curved line, the fish is of standard weight for its length. If the point lies above the curve, it is heavier than average. If it lies below the curve, the fish is underweight.

then, total weight loss by natural deaths in the population begins to exceed total weight gain by body growth. The more fish that are taken by angling, the fewer that can be lost to other causes. The greatest yield of fish and enjoyment can usually be obtained by doing most of the harvest during the fishing season in which the trout reach 7-10 inches.

Experience over the years may show how much you should spread out the angling harvest over the season to get the results that you want.

Under a "put-grow-and-catch" scheme of management, trout grow while the harvest is spread out over the season each year. You should be able to harvest an amount of trout about equal in weight to the total poundage that exists in the pond at the start of summer. This is because body growth of the remaining trout fills in for those removed.

Under "put-and-take" management for rapid catch-out of one or repeated stockings of trout in one season, many times more pounds of trout can be caught than is the momentary capacity of the pond to support—but you'll never catch as many pounds of trout as were stocked. There isn't time for the trout to make use of the food supply and to grow enough to compensate for the usual high post-stocking mortality. The cost per pound of fish caught will be much higher than in put-grow-and-catch stocking.

A put-and-take fishery may be appropriate for ponds where temperatures are suitable for trout only in spring and fall.

Artificial Feeding

Supplemental feeding shouldn't be needed if the stocking rates in Table 8-1 are followed. At these densities, the trout should have enough natural food to sustain desirable growth.

Higher population densities can be maintained if feed is added. Some people keep as much as 5,000 pounds of trout per acre in hard-water ponds with artificial feeding—and harvest that amount annually. This can only be done where a

strong supply of spring water keeps temperatures low and rapidly replenishes the oxygen consumed by decaying feed and fish wastes.

However, there are disadvantages to such intense management. Once the population is built up to the level needing feed, then the trout must be fed almost daily during the growing season. "Feed lot" conditions are created, and pond appearance may become unpleasant. Excess feed and the unavoidable large amounts of trout feces raise water fertility to levels causing undesirable algae growths. The accumulation of unused feed, trout wastes, living and dead plant matter, and decay microorganisms in the pond consumes large amounts of dissolved oxygen. Having too little oxygen hampers trout growth and, if severe enough, kills them. In softwater ponds especially, excess enrichment can cause fluctuations of pH (acidity-alkalinity) which are intolerable for trout. This situation gets so bad that the pond must be redredged if it is to be further used for trout.

If there must be supplemental feeding, give no more feed at one time than the trout eat immediately. This minimizes residue of unused feed and reduces cost.

Convenient pelleted dry feed is available from livestock feed stores. Use only those especially made for trout. Feeds for other animals (such as chickens) don't have the ingredients in the right proportions and won't work. In most cases, floating pellets are best. They stay up where trout can find them longer—and where **you** can see when they have had enough.

Special Aquatic Plant Control in Trout Ponds

Amounts of algae and rooted plants should be kept moderately low in trout ponds. While water plants produce oxygen in daylight, they consume more than they produce at night. An overabundance of plants, together with the decay of dead plants, may reduce dissolved oxygen levels below the trout's needs especially on hot summer nights or in the darkness of winter

ice cover. See Chapter 10 for information on aquatic plant control.

CAUTION: Trout are generally more sensitive than are warmwater fishes to chemicals used to kill algae (algicides) or rooted plants (herbicides). Some of the chemicals will kill trout at the concentrations needed to kill the intended plants. For example, the commonly used algae-killing chemical, copper sulfate, should never be used in trout ponds. No other copper compound such as Cutrine (chelated copper) should be used either. Before buying any chemical for killing aquatic plants in a trout pond, determine its effect on trout. It will be safer to remove plants by mechanical means (Chapter 10).

Artificially Circulating the Pond Water

If the pond is having dissolved oxygen problems which threaten to make it unsuitable for trout, redredging is the best solution. However, it may help to circulate the water by the air-lift method to achieve better aeration. Injecting a stream of air bubbles at the bed in the deepest part of the pond creates vertical circulation of the pond because the bubbles draw bottom water toward the top as they rise. At the surface, the oxygen-poor water spreads and takes on oxygen from the atmosphere. Surface water circulates to the bottom to replace it.

The bubble stream is produced by a compressor on the pond bank. The air passes through a hose along the pond bed to an air stone or other dispenser. A variety of air-lift circulation systems are sold especially for lake and pond use (Appendix).

The circulation prevents pond water from layering and stagnation which may occur in summer and winter. Circulation may also keep part of the pond surface unfrozen in winter.

One risk with circulating a trout pond in summer is that the entire pond may be warmed beyond tolerance for trout. There are special devices for aerating only the deep, cool part of the pond, without mixing into it the warm surface water.

Fish Population Control

Pond owners sometimes need to reduce or eliminate fish populations before further management. An older pond may have become contaminated with undesirable fish, such as carp, suckers or bullheads. A trout pond may contain unwanted warmwater fishes which are competing for food and reducing trout growth and survival. It may be that a pond has suffered a winterkill for one kind of fish but not for others, disrupting the predator-prey balance. Or perhaps panfish are overabundant and stunted. When such situations occur, various methods exist to alter fish population structure or remove the population completely.

Intensive Angling

It is often thought that panfish overabundance can be prevented or remedied by fishing hard and keeping many. That's fine in theory, but almost nobody has time for enough fishing to accomplish it. For reducing panfish overpopulation, angling is rarely effective. To best prevent overabundance follow the harvest suggestions outlined in Chapter 7 of this bulletin.

Predator Stocking

Some people reason that stocking northern pike, muskellunge or wall-eyes should result in panfish control. But in numerous efforts to achieve this, there isn't one well-recorded example of success.

Bluegills and other sunfish have deep bodies with a spiny fin along the back, and predators must have especially large throats to swallow them. Although largemouth bass at-

tain the necessary throat size at a smaller size and earlier age than other piscivorous fishes do, they do not keep bluegill populations in check in Michigan.

All piscivorous fishes, including largemouth bass, much prefer to eat forage fishes that are more cigar-shaped and lack spiny fins. Thus, no predator fishes eat many panfish until other, more convenient prey, such as minnows, are used up.

Having northern pike in bass-bluegill ponds often results in more predation on bass than on bluegills. Even though they also have spines, bass are less deep-bodied and are easier for pike to swallow.

Control of carp and suckers in ponds is rarely achieved by introducing large predators. By the time suckers or carp become a problem, they are usually too large and numerous for piscivorous fish to achieve control.

Spawning Bed Destruction

Some people have tried to control sunfish populations by destroying their eggs, either through raking or trampling the nests. However, you have to get almost every nest to be effective. Sunfish spawn over such a long period, hatch in so few days, and hatch so many fry in each nest that such control is a long, hard task with high risk of failure. Even if it were effective, the result wouldn't be worth the effort.

Cover Reduction

Panfish can rapidly overpopulate a pond when cover in which they can hide from predators is abun-



dant. This commonly occurs where overly **dense** stands of aquatic plants occupy too much of the pond. Scattered stands with moderate plant density (about 80 stems per square yard or meter) promote a better balance between predator and prey fishes. Methods for controlling aquatic plants are discussed in Chapter 10.

Water Level Drawdown

In some cases, fish populations can be controlled by manipulating pond water level. The water level can most easily be drawn down and raised again if the pond is formed by a dam with a proper water control structure to regulate the outlet. To draw down undrainable ponds, low-head pumps or a siphon can be used. The length of time needed for the pond to refill should be considered.

Whenever water is discharged from a pond, take care to insure that downstream waters or properties are not damaged by flooding, erosion or sedimentation. It is the owner's responsibility to release the water in a judicious, reasonable and prudent manner.

Fish present in the pond may not be released into public waters without a permit from the MDNR Fisheries Division. Unauthorized introductions of fish can disrupt natural fish populations to the detriment of public interest. Contact the MDNR District Fisheries Biologist whenever a drawdown or other water release from a pond is desired.

Total Drawdown is used to eliminate all fish from the pond. A special effort must be made not to overlook fish that may find refuge in residual puddles. Spot applications of fish toxicant chemicals may help in attaining complete kill. Desired fish, such as large bass, can usually be salvaged and kept alive for restocking, if other water for holding them is available.

Partial drawdown is usually used to concentrate fish so that predators like bass can become more efficient. This tactic depends on having enough predators to consume a large portion of the unwanted fish. When the pond refills, the survivors

may be able to make better use of the existing food supply, if over-abundant aquatic plants have been killed by drying during the draw-down, as is often the case. Predatory reduction of small fishes will be most effective if the partial draw-down is done for a month or more in July or August. Carefully consider whether there will be increased danger of oxygen depletion and mass fish die-off during partial drawdown.

Seining

Fish can be removed by drawing a seine through the water. This is often the most effective method for reducing numbers of unwanted fish in small ponds. Seining is usually done by two people, each holding a wooden upright which supports an end of the net. Floats keep the seine top at the water surface, and weights hold the bottom edge on the pond bed. For best results, the seine must be deeper than the deepest part of the pond so that it will "belly" without being pulled away from the pond bed as it is drawn along. The seine must stay tight along the pond bed, or fish will escape underneath.

Small "minnow seines" of 15-40 feet (5-12 meters), available at sporting goods shops, can be used along shorelines to remove panfish fry and fingerlings. Small seines may be especially useful on panfish

during spawning periods. Longer, deeper seines allow greater coverage. Seines of 50-200 feet (15-60 meters) can be built to fit your pond.

Use nylon netting. It is most rip-resistant and lasts long with little maintenance. For removing small panfish, use netting with mesh of from $\frac{1}{4}$ to $\frac{1}{2}$ inch ($\frac{1}{2}$ to 1 cm). Smaller mesh isn't needed and is harder to draw through the water. Larger mesh will let those fish escape that are often the most important to remove.

Ready-made or custom-built seines can be ordered from various suppliers (Appendix). You can also make them yourself with netting, cord, floats and weights from the same sources.

For seining, the pond bed should be smooth and free of snags such as rocks, logs and brush. Dense weed beds also impede seining. Water-level drawdown (described previously in this chapter) can aid in seining by drawing the water away from weed beds and other shore-zone obstructions, as well as decreasing the area and depth to be seined.

If the seine spans the pond's width, two people can draw it the length of the pond in one sweep. This is the most efficient method. If the pond is too wide for that, pull the seine out from shore in an arc—using a boat if needed—and back to shore. Draw the arc tighter and into

Seining a pond.



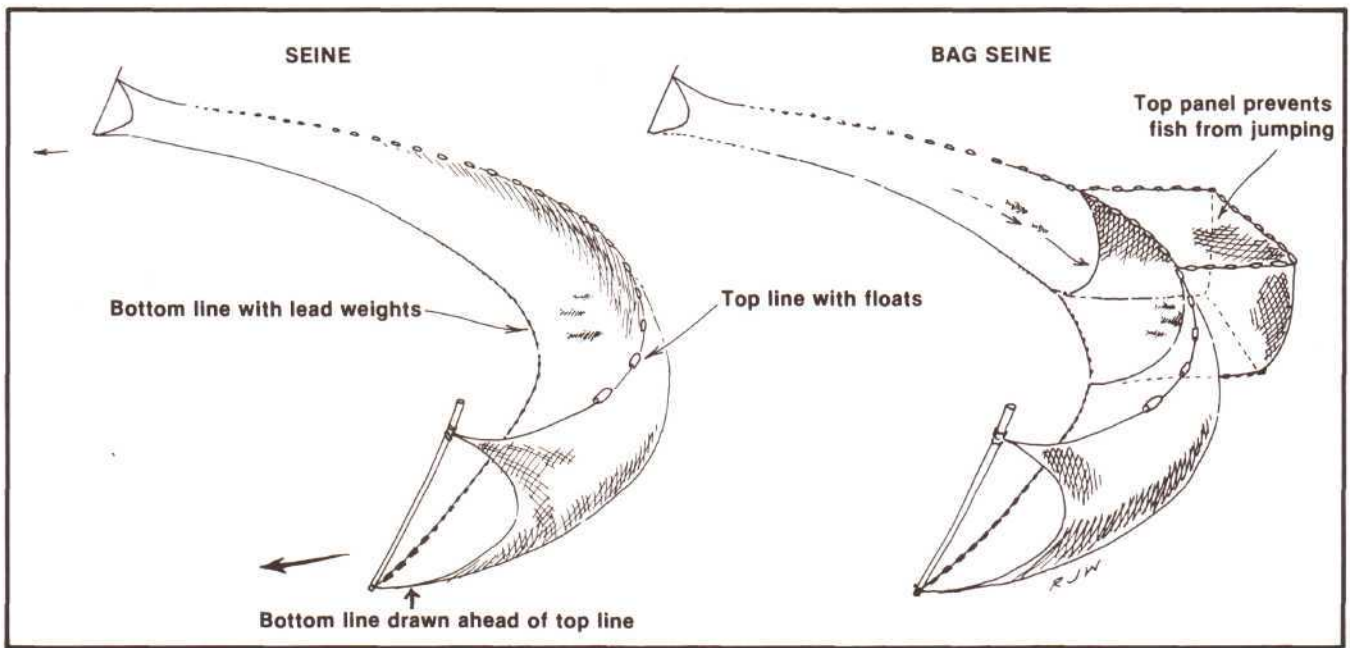

A seine and a bag seine.

shallow water or onto shore. Such shoreline seining, even when repeated all around the pond, usually achieves a far less complete catch than with a seine that spans the pond and is of proper depth.

Draw the seine so that the bottom edge stays ahead of the upper edge. Many fish escape if a seine rolls up at the bottom as it is pulled along.

To salvage bass, large panfish, or minnows and return them to the pond uninjured, pocket the seine in shallow water at the end of the haul, rather than dragging it ashore. Rolling or sandwiching the net can greatly harm fish by bruising them and by removing their slimy covering and scales, thus increasing susceptibility to infection and disease. Minnows are very prone to such injury—especially in hot weather.

To “thin out” populations of bluegills or other sunfishes, seine frequently in the warm season when there is almost continual hatching of sunfish. Remove panfish that are less than 6 inches (15 cm) long, and return the over-6-inchers plus any bass or channel catfish (not bullheads!). This amounts to selective breeding for the trait of fast growth—while making room for that growth to occur.

Keep seining until about 80 per-

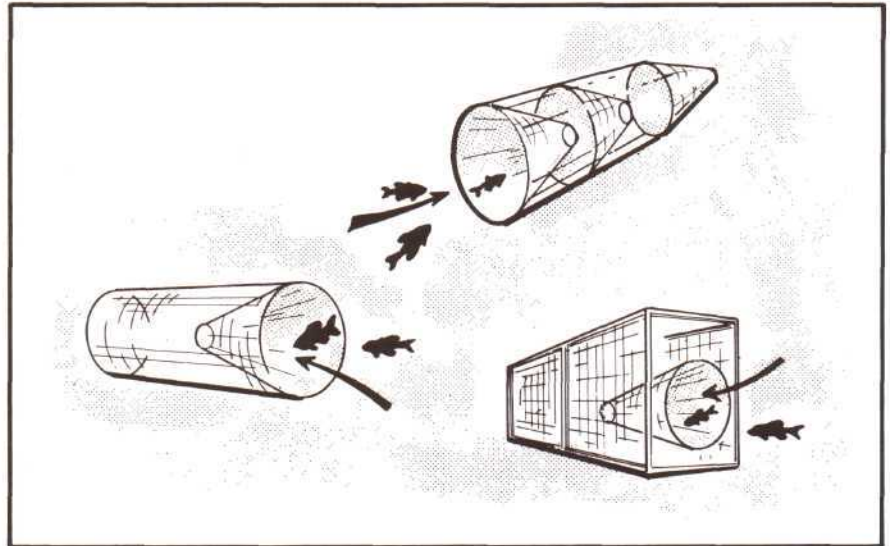

Various kinds of fish traps.

cent of the pond’s estimated summer poundage of panfish has been removed. Estimating the total weight of panfish in a pond is difficult, and it is best to consult a professional biologist in your local area on this.

Seining is hard work but can be fun. It can provide useful information about the fish population but can also give misleading impressions. Bass and carp, especially the older ones, are adept at avoiding nets. When you seine up only small bass or carp, don’t conclude that big ones aren’t there.

Live-Trapping

Fish traps may be useful for reducing populations in ponds that have obstacles to seining. An effective trap can be made of ½-inch (1-cm) hardware cloth on wooden framing.

Use traps with or without “wings,” which are like fences extending outward from the mouth of the trap. They guide fish toward the opening. Wings can be any length that is convenient.

Place traps in water which is just deep enough to cover them, parallel

or at right angles to the shore, off peninsulas, or in shallow bays where small fish gather. Support traps and wings with poles or iron reinforcing rods driven into the bed. Up to 10 traps per acre (25 per hectare) may be needed.

For panfish thinning, remove the same amounts and sizes of fish as described in the section on seining. Take fish out of traps daily. Otherwise, turtles may be attracted and eat the desirable fish.

Gauze bags of bait, such as bread, oatmeal, soybean cake, or cottage cheese, can be hung in traps to increase catch, but aren't necessary.

Fish Toxicants

Another method of "reclaiming" ponds from panfish overpopulation or presence of undesirable fishes is to kill all fish with a chemical especially formulated to be a fish toxicant* or "piscicide". Then start anew by stocking a suitable population after the water has detoxified. Some fish can be salvaged before or during "treatment" and kept alive in other water for restocking.

"Partial treatments" to remove only certain species or sizes of fish, or to merely reduce rather than eradicate the population, can be done by applying special dosages or by treating only small parts of a large pond at one time. Partial treatments are usually very difficult and probably should be attempted only with professional help.

Only two chemicals, **rotenone** and **antimycin**, are now legally registered for use as fish toxicants. The commercial brand names and sources are listed in the Appendix. Federal law requires that only legally registered fish toxicants be used—and that they be applied strictly in accordance with instructions on the product label.

The amount of toxicant needed for total removal of fish may depend on several factors, including the kind(s) of fish to be killed, pond volume, water temperature, water

*The chemical is absorbed into the fish's gills and kills by interfering with respiration. This does not mean that the pond is made poisonous for humans, for any vertebrate animals other than fish, or for most invertebrates when used at the dosages prescribed for killing fish.

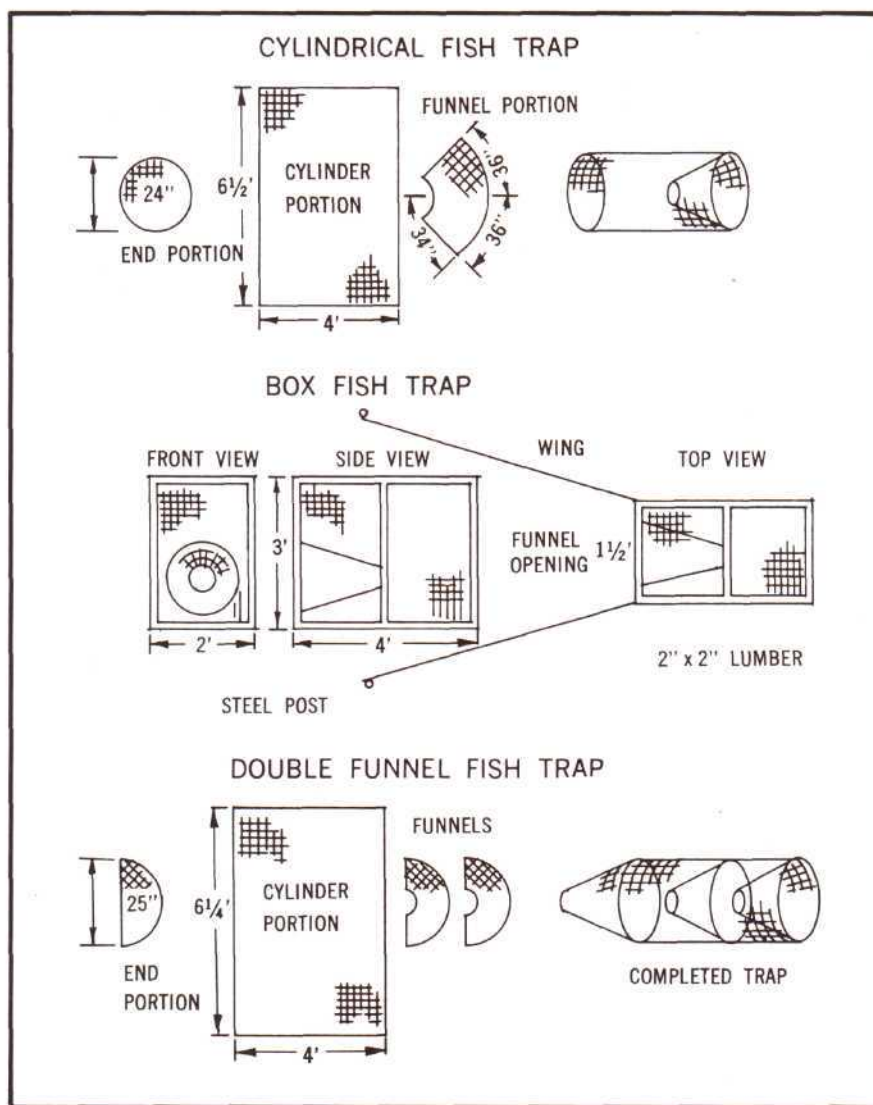

Fish trap construction.

hardness, light conditions, abundance of aquatic plants, and amount of other organic matter present. Correct application of fish toxicants is difficult. It is best to seek the services of a professional fishery biologist in planning and carrying out chemical treatment.

A special permit from the DNR District Fisheries Biologist is needed before applying a toxicant to any pond that is connected with surface water other than that which is completely within the property of the same pond owner. This means, essentially, any pond with an outlet.

If the pond has an outlet, special care must be taken to insure that fish aren't killed downstream. The

person who applies the toxicant is legally and financially responsible for fish killed beyond the limits of the pond. It is well to engage a licensed commercial aquatic pesticide applicator who is skilled in preventing downstream "overkill" and can take responsibility. Licensed applicators also have blanket permits, eliminating the need for pond owners to apply for permits and wait the 3 weeks or more which it takes for processing before approval.

Further information can be found in the Michigan DNR manual, "Eradication of Fish by Chemical Treatment" (Fisheries Division Pamphlet No. 19).

Aquatic Plants And Their Control

Aquatic plants play essential roles in the recreational fish pond. The healthy pond will have moderate amounts of a variety of plants. Plants become overabundant and interfere with pond use when—and only when—nutrients are too abundant. We then view the plants as weeds to be controlled.

Control of the overenrichment-overvegetation problem is one of the most common pond management needs. The way to prevent a pond from becoming algae-ridden or weed-choked is to keep excessive amounts of nutrients from getting into the water. The only permanent way to restore a pond from plant overabundance is to halt the over-supply of nutrients. Trying to control plants by cutting or with chemicals is only temporary. Overzealous use of chemicals (herbicides and algicides) to poison plants may damage the health of the pond community and should be avoided.

Plants not only release oxygen and serve as the producer base of the pond's food web, they also furnish cover in which fish like to rest, and they support organisms that fish eat. Having a few well-spaced plant beds can provide prime fishing spots. Certain vegetation also attracts waterfowl and other enjoyable wildlife.

The disadvantages of too many pond plants can include:

- Unfavorable build-up of organic matter on the bed.
- Daytime overproduction of oxygen to an extent toxic for fish.
- Nighttime overconsumption of oxygen to a point where fish do not get enough.
- Daily changes in acidity/alka-

linity balance of the water which are unfavorable to fish and other organisms.

- Too much cover for small fish to hide from predator fish, resulting in overpopulation of the pond with small fish.
- Interference with fishing, boating and other activities—including seining to control fish populations.

If less than a fourth of the pond surface is covered by plants, there is probably no problem unless this interferes seriously with use of the pond. Even much more vegetation than that may pose no threat to the welfare of pond fish.

Kinds of Plants

The many kinds of pond plants are in two general groups: **algae** and **rooted leafy plants**. The latter have flowers.

Algae (the plural of alga) are single-cell plants or colonies of cells lacking true roots, leaves or flowers. There are three types of algae:

— **Planktonic algae** drift free in the water, are usually microscopic in size, and, when abundant, make the water look murky. Algal murk may range in color from green to yellow and brown or even gray.

— **Filamentous algae** are thread-like or netlike. They may be small and free-drifting but often occur as “mossy” growth on rocks, plants and other firm objects. Some kinds form a water surface scum or a slimy, felt-like mat on the pond bed. Most scums and mats are actually communities containing many bacteria and fungi, as well as algae.

— **Chara algae**, also called muskgrass or stonewort, grow attached to



the pond bed without true roots, have clustered needle-like projections, and are often mistaken for leafy plants. The two common kinds are chara and nitella. When mashed between the fingers, they both feel gritty and give off a musk-like odor. There is often a white or brownish crust of lime or "scale" on the plants. Chara occurs under natural conditions as small clumps about 6 to 8 inches high. When over-fertilized, it forms continuous

stands several feet high. Overabundance of chara is a common pond problem.

Rooted, leafy plants also occur in three general forms:

—**Submergent plants** (or submersed plants) grow rooted to the bottom with most parts beneath water. Some have a few leaves floating at the surface. Many thrust blossoms above the water. Common submergents are pondweed (*Potamogeton* in many varieties), coontail,

milfoil, waterweed (*Elodea*), water buttercup and bladderwort.

—**Floating plants** have all or most of their leaves and flowers at the water surface and roots dangling free in the water or rooted in the pond bed.

—**Emergent plants** (or emersed plants) have stems and leaves thrust above the water. These grow at pond margins and may extend into water several feet deep.

Algae

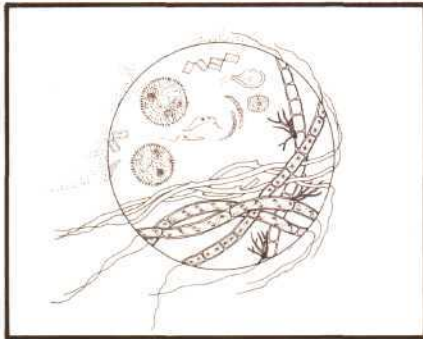

Planktonic algae (many species) — free-floating, usually minute, may be single-celled or in colonies. When abundant, they may color the water murky greenish to brownish—or in extreme cases give the water a pea-soup appearance.

Filamentous algae (many species) — long strands, filaments or nets. Often form floating mats.

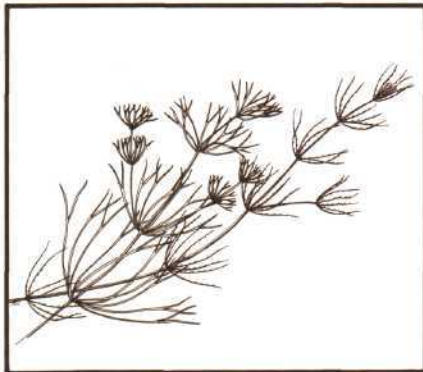

Chara algae (muskgrass or stonewort) — Upright plants attached to pond bed. Roughly resemble rooted, flowering plants, but are really algal colonies with stems and whorled branches. Each joint of the stem consists of a single cell. Even-lengthed branches are clustered at each joint. Chara algae occur in shallow waters having high alkalinity. They are rough to the touch. When crushed between fingers, it feels gritty and gives off an ill-smelling, skunk-like odor.

Submergent Plants

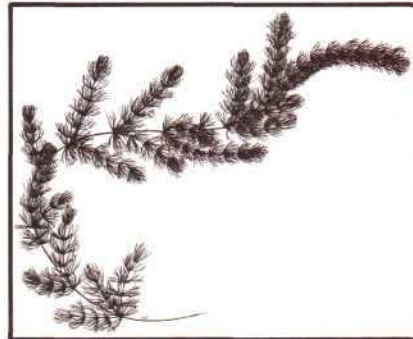

Coontail (*Ceratophyllum demersum*) — Whorls of leaves at joints of stems. Leaflets forked once or more, have toothed edges. Leaves densely crowded near tip of stem. Grows in hard water.

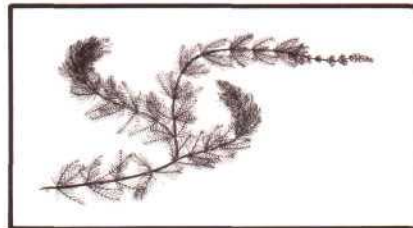

Water milfoil (*Myriophyllum* species) — Leaves whorled on stem and divided feather-like, not forked as in coontail.

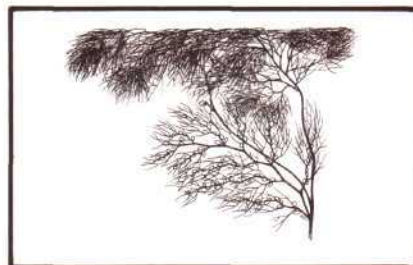

Bladderwort (*Utricularia* species) — Tiny oval bladder near bases of finely divided leaves. Often floats free under surface without roots. Found in cold, acid water. Flowers yellow or purple.

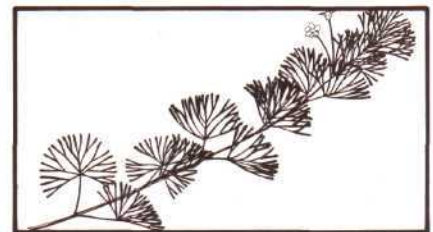

Fanwort (*Cabomba caroliniana*) — Leaves fan-shaped. Leaflets forked and wider at tip than at base. Sometimes small floating leaves. Plants have gelatinous slime. Flowers white to lavender.

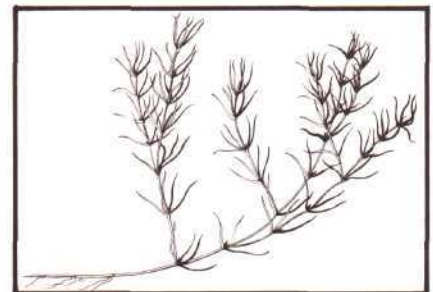

Naiad (*Najas* species) — Leaves occur as opposite pairs or whorled, very narrow, toothed on edges. Commonly grows in water 1 to 4 feet deep but sometimes much deeper.

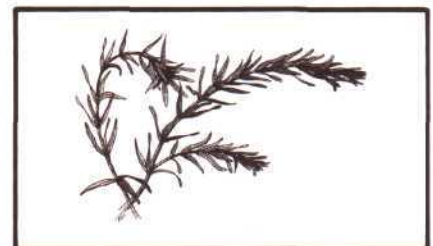

Elodea (*Elodea canadensis*) — Flat, thin leaves occur in opposite pairs or whorled. This plant commonly used in home aquaria.

Submergent Plants (Continued)

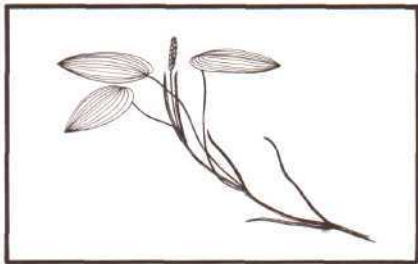

Floating pondweed (*Potamogeton natans*)—Has two types of leaves. Underwater leaves are narrow, grass-like, and appear as stalks. Floating leaves are oval to heart-shaped, each with notched base. Flowers and seeds on a spike.



Curly pondweed (*Potamogeton crispus*)—Leaves alternate, have finely toothed, crinkled, or puckered edges. No floating leaves. Flowers and seeds in spike at tip extending above water for fertilization. Grows in fertile hard water. Introduced from Europe.

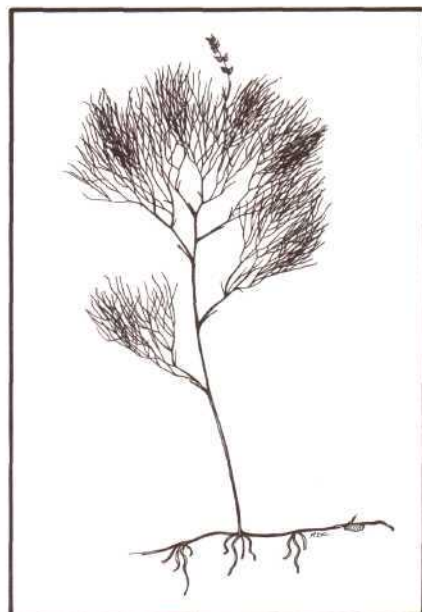

Sago pondweed (*Potamogeton pectinatus*)—Leaves fine, thread-like, and spread as a fan, have sheathed base. No floating leaves. Stems usually multi-branched. Tubers grow from horizontal roots.

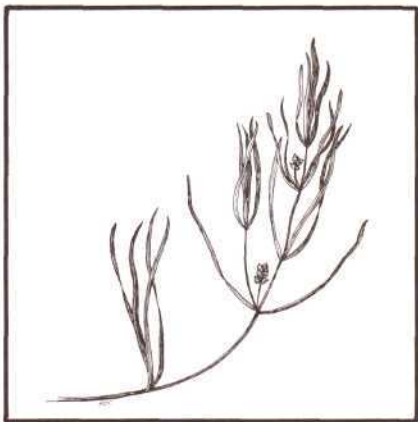

Leafy pondweed (*Potamogeton foliosus*)—Leaves ribbon-like, about 1/16-inch wide, lack sheath at base.

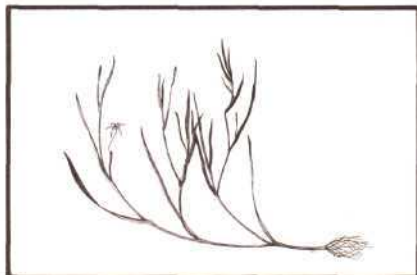

Water-stargrass (*Heteranthera dubia*)—Looks like some narrow-leaved pondweeds (*Potamogeton*), but leaves lack a midvein. Flower yellow, star-like.

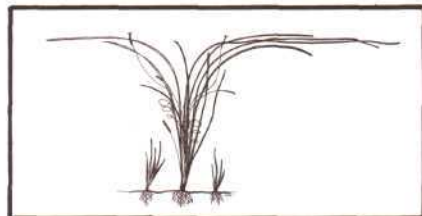

Wild celery (*Vallisneria spiralis*)—Light green, ribbon-like leaves may be as long as 6 feet (but usually much less), with tips floating on surface.

Floating Plants

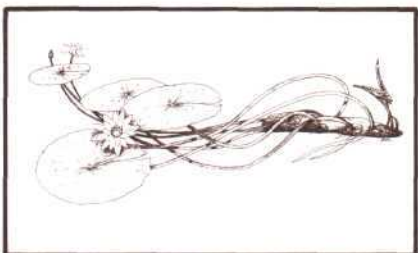

White waterlily (*Nymphaea odorata*)—Round floating leaves grow to 10 inches diameter, split to stem at center, often purple on underside. Flowers showy, usually white but sometimes pink. Flowers open from morning until shortly after midday.

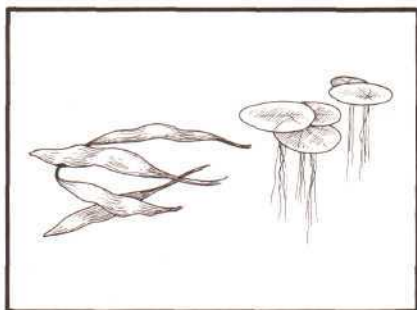

Duckweed (*Lemna* species)—Tiny, free-floating, bodies are flat and round or lobed, oatmeal-sized or smaller, often mistaken for algae. Barely-visible roots dangle thread-like. Sometimes several plants attached. Masses of this plant accumulate as a scum blanketing quiet shallows. As scum dies, it turns yellowish or whitish.

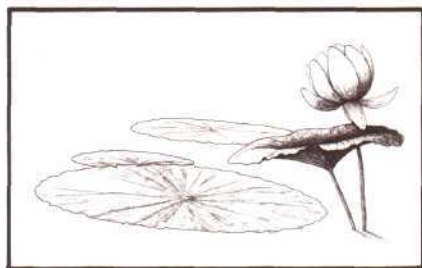

Lotus (*Nelumbo lutea*)—Round floating leaves grow to 24 inches with a depression in center where stem attached. Leaf veins radiate from center. Flowers yellow, large, showy.

Emergent Plants

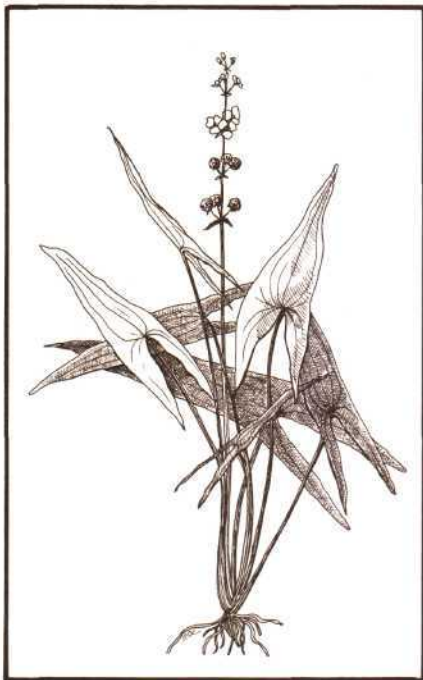

Arrowhead (*Sagittaria* species)—Leaves usually arrow-shaped, but some may be tongue-like or ribbon-like, especially at base of plant or underwater. Flowers white, 3-petaled, whorled and grow near tip of a stalk. Fruits are tightly-packed balls of seeds.



Pickerelweed (*Pontederia cordata*)—Leaves heart-shaped, similar to those of arrowhead but rounded at tip and corners. Curving veins follow leaf margin. Flowers blue and grow in a spike.

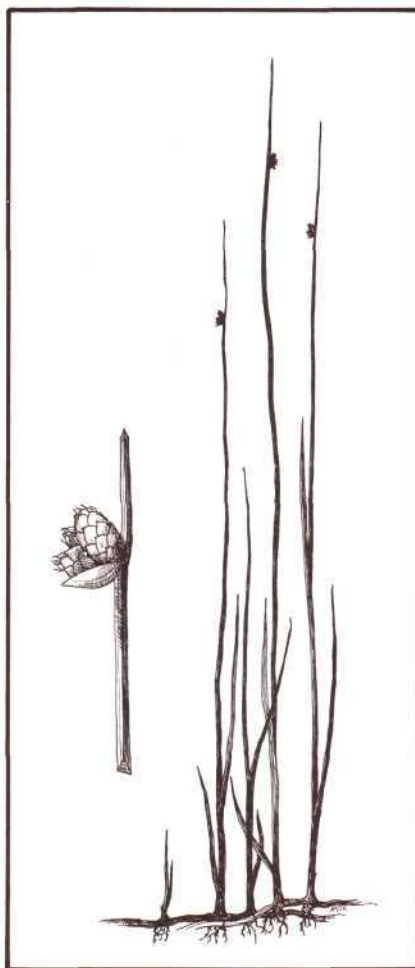

Bulrush (*Scirpus americanus*)—Horizontal rootstocks give rise to stems with triangular cross section (but round in some bulrushes). Height usually 2 to 3 feet. Flowers and seeds on spikes along stem near tip. The plants may form dense stands after several years.

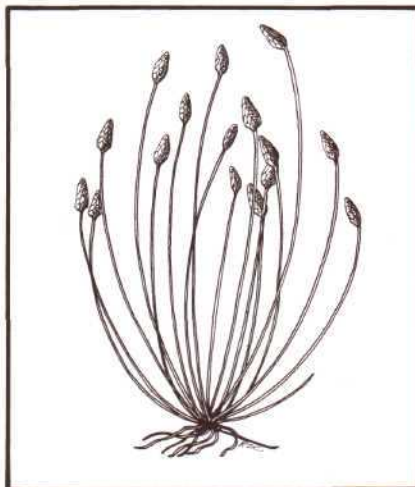

Spikerush (*Eleocharis* species)—Clumps of stems rise from shallow roots, remain much shorter than rushes. Oval fruiting spike at end of stem.

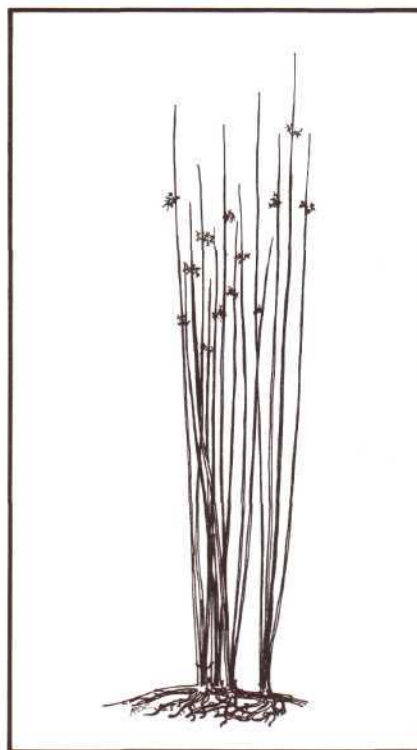

Rush (*Juncus effusus*)—Clumps of stems rise from stout horizontal rootstocks, grow 3 to 4 feet tall resembling grasses and sedges. Greenish-brown flowers near tip of stem.



Burreed (*Sparganium eurycarpum*)—Leaves long, erect, ribbon-like, usually 1 to 3 feet high. Stems bear male flowers at tip, female flowers below. Fruiting heads are one-inch round balls containing many seeds.

Emergent Plants

(Continued)

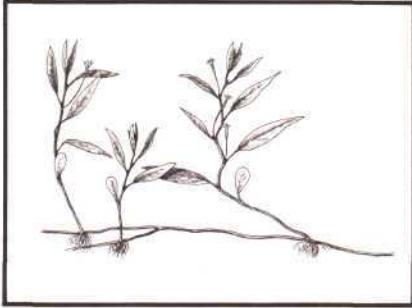

Water primrose (*Jussiaea repens*)—Leaves oval to lance-shaped, grow to 3 inches long. Plants sprawl or partly float in shallow water. Rooted at nodes on stem. Flowers yellow.

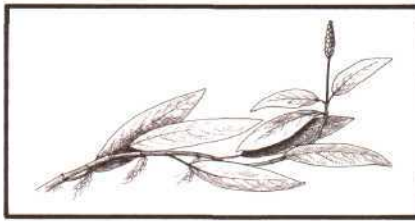

Water smartweed (*Polygonum amphibium*)—Leaves elliptical, up to 4 inches long. Stems upright or sprawling in water or on mud banks. Deep pink flowers in spike at tip of plant.



Watercress (*Nasturtium officinale*)—Grows in tangled or billowy masses. Leaves compound with 3 or more segments, of which the one at tip is largest. Roots form at stem joints. Flowers very small and white in lacy clusters. Especially common in springs.



Cattail (*Typha latifolia*)—Leaves reach to 6 feet tall, ribbon-like, taper to a point. Flowers on stalks taller than leaves. Male flowers at tips, female flowers below. The plants grow at water's edge but commonly also to depths of 3 to 4 feet.

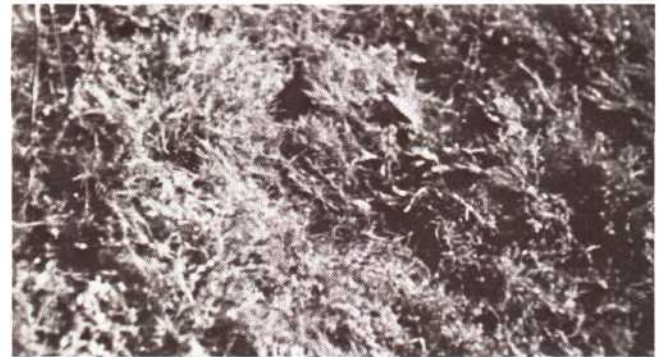
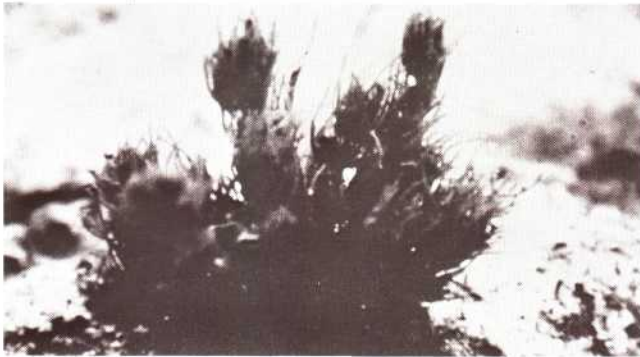

Chara algae or "muskgrass" grows in small, isolated clumps only 6 to 8 inches high when nutrients are in low to moderate supply (left), but rapidly form dense, continuous stands up to 5 or 6 feet high in the water when pond overenrichment occurs (right).

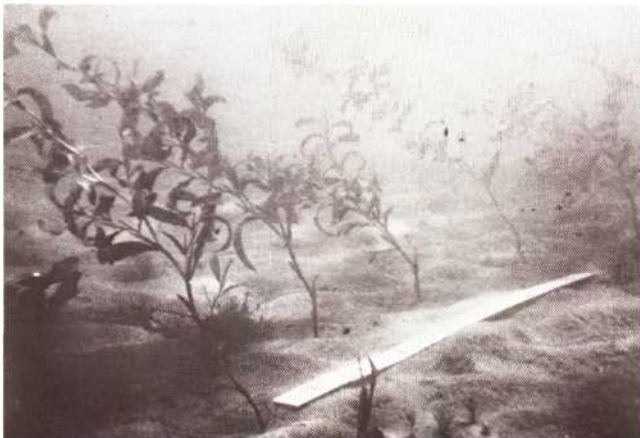

Leafy submergent plants also change from growths of tolerable density (left), beneficial to fishes and other pond life, to dense, continuous stands (right) that crowd out other life and interfere with recreation when ponds receive too much nutrient.

How Nuisance Growths Occur

Understanding how pond plant overabundance happens helps in determining how to prevent it or how to do something about it once it has happened.

Shallow ponds and shallow parts of deep ponds tend to be ideal places for plant growth. Most of the water and pond bed are well lighted. The water here becomes warm. Pond vegetation increases until it has used up the nutrient substance which is scarcest relative to the needs of the plants. The vegetation will increase and decrease during the growing season according to availability of the key nutrient, called the "limiting factor." Therefore, controlling the availability of that key nutrient controls the amount of pond vegetation.

The key nutrient is usually phosphorus. Even if phosphorus is not the limiting factor in a particular pond at the moment, it usually can be reduced enough to make it the limiting factor. Nitrogen tends to become the limiting factor in ponds which receive more phosphorus than the plants need. But in these cases, it may be much easier to lower the phosphorus supply below the level where it becomes limiting than to sufficiently reduce the nitrogen supply. This is because nitrogen is readily available as a gas in the air. Certain algae and bacteria convert it to a form that pond plants can use. In contrast, phosphorus doesn't occur as a gas in air. It is tightly held in land vegetation and topsoil. Nuisance-causing amounts of phosphorus aren't usually available to pond plants unless human activity disturbs surrounding land, and topsoil erodes into the pond—or unless fertilizers and the wastes of humans or animals are allowed to wash into the pond. These unnatural sources of phosphorus can often be much reduced or completely eliminated.

A deep pond with much of its bed below the well-lit zone absorbs more nutrient without undergoing nuisance plant growth and has greater self-restorative powers, once the nutrient oversupply is shut off. Phosphorus becomes tied up in the

bodies of plants and other organisms which die and drift to the pond bed, forming organic deposits rich in this nutrient. Where the pond bed is so deep as to prevent the mud from receiving enough light for plant growth, most of the phosphorus stays locked away in the mud, as long as the water just at the mud surface contains dissolved oxygen. Without oxygen, chemical reactions occur which allow phosphorus to diffuse back up into the pond. If the mud deposit builds up high enough that its surface is raised to a level receiving enough light for rooted plants to grow in it, these plants will pump phosphorus from the mud into the pond water. This accelerates overenrichment and plant production throughout the pond.

Vegetation Control by Restricting Phosphorus Supply

Because high phosphorus levels usually contribute to nuisance plant growth, reducing the pond's phosphorus supply is usually the most essential step in controlling plants.

There are many sources of phosphorus, however, the most important ones and some actions to remedy them are:

Materials from Surrounding Land

Soil erosion from land disturbance, such as cropland tillage or road and housing construction. Keep landscape disturbance to a minimum in the pond's drainage basin. Tillage and construction should be done in ways that cause as little erosion as possible.

Inflow of storm water, whether directly from surrounding slopes or through ditches and pipes. The problem is made worse by pavement, roofs and other hard surfaces that prevent water from soaking into the ground. Do not connect ponds with storm drains. Divert local runoff away from ponds with berms and ditches. Keep a buffer strip of vegetation around as much of the pond edge as possible, so as to intercept local runoff. Soil, leaves and other nutrient material washed or blown from surrounding land will largely be caught in a "bristle filter" of high grass and marsh plants.

Table 10-1. Common nitrogen sources for lawn fertilization.

Type of fertilizer	Common name	Nitrogen content & release rate	Lbs. needed to equal 1 lb. nitrogen	Remarks
Water soluble, inorganic	Ammonium nitrate	33% (rapid)	3	Most effective for rapid green-up and growth when soil temperature is below 55-60°F (before May 15). Strongly acidifying on soil. May cause burning of growing turf if not watered-in immediately.
	Ammonium sulfate	20% (rapid)		
Water soluble, organic	Urea	45% (rapid)	2.2	Slightly less available than soluble, inorganic forms when soil temp. is below 55-60°F, but other characteristics are similar. May cause burning of growing turf, if not watered-in immediately.
Water insoluble, natural organic	Processed sewage	5 to 6% 5 to 10% (moderately slow)	20-17 20-10	Also contains some phosphorus. Release of available nitrogen forms most rapid when soil temperature is above 55-60°F. Minimum danger of burning turf.
Water insoluble, synthetic organic	Urea formaldehydes	38% (slow)	2.6	Slow nitrogen release until soil temperature is above 55-60°F. Normally mixed with soluble, readily available forms. Minimum danger of burning turf when used alone.
	IBDU	31% (slow)	3.2	Faster nitrogen release with higher soil moisture. Larger IBDU particles give slow nitrogen release. Not greatly affected by temperature. Minimum danger of burning turf when used.

Inflow from streams and agricultural drains. Even the purest-looking stream water will usually bring in excessive phosphorus and flush out little. Water from tiled fields and other wetland drainage tends to be especially rich in phosphorus. Do not use streams or drains as source-water for ponds, and locate ponds where they won't be flooded by high water from streams.

Tree leaves can be a massive source of phosphorus. Don't have trees so close as to shed leaves into the pond.

Crop and lawn fertilizers. Apply these sparingly and at times and in ways that reduce their loss in runoff. Use little or no fertilizer on land draining toward the pond. Use mainly nitrogen (Table 10-1) not phosphorus unless soil tests show it is needed, which is seldom the case. Rather than bluegrass, use fescue which needs less fertilizer and water. To promote healthy turf that needs less fertilizer and retains it better, keep it raked free of leaves, set mowing height at 2 to 2½ inches, and water sparingly, especially on sandy soil for less nutrient leaching.

Livestock wastes. Runoff from feedlots, barnyards and pastures should obviously be avoided.

Human wastes. Septic systems eventually leak phosphorus through the ground for distances as great as 300 or 400 feet in many Michigan situations—farther if the soil is shallow or the effluent seeps out of the ground and runs over land. Soils around septic systems become saturated with phosphorus and no longer remove it from the effluent. The better your soil passes the "percolation test," the more rapidly it may become saturated with phosphorus and let it through to your pond.

There are various ways to reduce or prevent escape of phosphorus from septic systems to pond. Locate the tank and/or drain field at least 300 feet away from the pond and in suitable soils at proper depth and on a slope not too steep. Add a dosage chamber to the septic system—and maintain it. Use no phosphate detergents or other phosphate cleansers. This reduces phosphorus content of septic effluent. No mat-

ter how septic systems are maintained, those closer than 300 or 400 feet to a pond probably won't be good for the pond. Some better method than septic systems should be used.

Consider alternative methods of waste disposal, such as composting toilets, other kinds of self-contained on-site sewage systems, municipal sewer hookup, or simply the traditional outhouse privy. Compost kitchen wastes rather than flushing them down a disposal grinder. Pour dishwater on your garden, lawn or angleworm-rearing bed rather than wasting it down the drain.

Pond Fertilization

Fertilizing a Michigan pond can do great damage if you wish to maintain it as a pleasant recreational fishery. Recommendations for fertilizing commercial or recreational ponds in southern states are sometimes applied in the North with unfortunate results. Fertilizer is used to increase southern fish production, also to create algal murk so dense that rooted plants are shaded out. But in regions of significant ice cover, this almost assures winter kill of fish. It can also cause summer kill, bring on other disadvantages of plant over-abundance and build up nutrients of shallow muds that lead to a continuing problem. If fertilization is done to stimulate such algal turbidity to control weeds, water quality and appearance may become objectionable.

Fish Food Application

Artificial feeding of fish should be avoided or greatly restricted if excessive vegetation is to be prevented. The wisest approach will often be to maintain no more fish than can grow well on the food naturally provided by the pond. However, if you want to have unnatural abundances of fish through supplemental feeding, feed as sparingly as possible—and be aware that you may be making a tradeoff in pond quality.

Vegetation Control by Temporary Methods

Pond treatments that don't control nutrient inflow can't control

aquatic vegetation more than temporarily. Increasing pond depth by dredging or by raising the water level may be of longer-lasting effect than other temporary treatments but has high initial cost and other drawbacks. Measures such as poisoning the plants with toxic chemicals, introducing other chemicals to inactivate nutrients, or removing the plants physically must be repeated for as many years as relief is desired. The cumulative cost can be huge, and more than one treatment per year may be needed.

The "temporary symptomatic relief" afforded by such measures may be desirable to ease the unpleasantness of nuisance vegetation during the time it takes to find and control nutrient sources for permanent solution. However, the cosmetic effects of short-term treatments shouldn't be allowed to so obscure the problem that one loses sight of the underlying causes to be cured.

Eliminating one type of vegetation may just make room for replacement by some other equally bothersome kind. This takes place annoyingly soon in some cases. For example, less than a month after cutting or poisoning rooted plants, the area may become clogged with stringy algae. Nature abhors a vacuum. As long as light, warmth and nutrients exist in a pond, it will strive to fill the water with vegetation.

The vegetation of most ponds will continually change, even if unaltered by humans. One type of plant tends to be replaced by others. We call this "natural succession." By this process, a pond vegetation problem may alleviate itself in a few years. For example, nuisance growths of chara algae have been replaced by other plants that are less bothersome in some cases—with no control needed.

If short-term controls, such as outlined below, are to be used, it may be a good idea to switch methods every year or two. The kinds of plants that can best withstand one type of treatment may increase, but are likely to be controlled if the method is changed.



Pulling plants out by hand will often be the simplest way to control vegetation in shallow water.

Physical Disruption and Removal

This method can be one of the simplest and most practical of temporary plant control methods. The cost can be low for some methods—or quite high for others. The methods are akin to cultivating, weeding and hoeing in a garden, or to mowing a meadow. Most aquatic plants are more fragile than garden weeds, however, and to this extent physical control may be easier for water plants than for land plants.

Frequent disturbance, such as raking of pond shallows, or trampling of beach areas by swimmers, can keep areas weed-free. Cattails are easily killed by trampling or cutting the new shoots in springtime. This may also work for most other emergent plants.

You can simply wade in and uproot many kinds of plants by hand. This works for cattails, rushes and other emergents when they are growing as isolated plants, as well as for submergent plants that can be reached in this manner. The first “weeding” of a well-established plant bed may be hard work, but follow-ups repeated often enough may keep the difficult situation from developing again.

A scythe or hoe can be useful for cutting aquatic weeds in shallow areas. **Caution:** Wielding a blade under water can be much more dangerous than in the air! Always

wear protective boots! The cut plants will float and should be removed from the pond as soon as possible. Deposit them where the nutrients will not run back into the pond as the plants decay.

A rake can be used for uprooting, tearing loose and dragging out plants. The head of a garden rake, fitted with an extra-long handle and manipulated from a boat or wading position is suitable for reaching into deep water. A floating rake is less tiring for work near the surface. If you don’t have an all-wooden, peg-tined rake, make a floating rake. Fashion a rake-head block by driving long spike nails at 2-to-3-inch intervals into a piece of light wood which is about 2 x 2 inches in cross-section and 18 to 24 inches long—or longer if you can handle it. Cut the spike heads off. Drill a hole in the block so a handle can be affixed. A bamboo pole makes a good handle. It can be very long yet light.

For weed growths too extensive to scythe or rake, a log loosely wrapped and stapled with barbed wire can be dragged through the pond behind a tractor driven along the shore. A heavy chain connecting log to tractor helps to sink the log to the pond bed. Add more weight as needed. The log can be guided with a rope manipulated by a person on an opposite shore. The barbwire log seems to be an improvement over the dragging often tried with bed-

springs—from which it is more difficult to disentangle weeds.

Mechanized harvesters are available in a wide range of sizes. Small models, costing less than \$1,000, can be mounted on a rowboat. These have cutter bars like those on hay mowers. With such boat-mounted units, weeds can be cut to a depth of about 4 feet. After the weeds are cut, they are raked to a removal point on shore. Other weed cutters are manufactured as mower bars on small paddlewheel barges. These can operate in very shallow water, as well as to depths of 5 feet or so. They range in price from about \$2,000-\$20,000. Large “harvester” units which draw plants onto the barge as they are cut are available for upwards of \$50,000.

Some plants are difficult to control with mechanized harvesters. Chara sinks when cut and is therefore hard to pick up. Milfoil, coontail and elodea are also hard to collect once they are cut. These kinds of plants spread by fragmentation. Each piece cut and not picked up may become a new plant. In small ponds, removal of these plants by hand or rake is probably preferable to mechanical harvest. Most plants are, however, easier to harvest mechanically than chara, milfoil, coontail and elodea.

Plant removal is best done at times of spring or summer when it will result in the maximum amount of plant material removed and still allow full recreational use of the pond. Such timing depends on your knowledge of the growth of the plants in the pond and your plans for pond use. Often, the best approach in a small pond will be periodic trimming as in caring for a lawn or garden. In new ponds, control plants by frequent hand or rake removal before they become abundant.

Harvested plants make good garden mulch, soil conditioner and composting material. The thin cell walls of aquatic plants break down rapidly and the resulting fine-textured matter may even be suitable for spreading on lawns.

Deepening the Pond to Control Vegetation*

Deepening to renovate an existing plant-clogged pond, can be achieved by dredging out the pond bed, or if a dammed pond, by raising the water level. One effect of greater pond depth on aquatic vegetation is to put more of the bed at a level that is too dark for rooted plants. It's hard to say what water depth will be critical in preventing nuisance growths of rooted plants. That depends on water clarity, the kinds of plants present and nutrient supply. Having 15 feet of water should greatly reduce plant growths reaching close enough to the water surface to interfere with boating and swimming. Depths of 18 feet or more will often rule out nuisance growths of plants. **Warning:** since late 1960s a new aquatic weed, Eurasian water milfoil, has entered Michigan. It "takes over" ponds and lakes which have abnormal nutrient enrichment. In some situations, it has grown to the surface in water 18-20 feet deep.

In the case of dredging, another effect on rooted plants is to deprive them of nutrients from organic deposits in shallow water. Dredging can also create steeper side slopes on which plants seem to grow poorly.

Increasing the depth and volume of the pond can have other beneficial effects with regard to its ability to deal with nutrient load and its suitability for fish. Consider these in deciding whether the expense is justified. The cost of deepening a pond can be immense, whether one modifies a dam, dredges by suction, digs with a dragline, or drains and bulldozes the bed. Finding a site for disposal of dredged materials and containing them so they do not flow back into the pond or spill into other water bodies can be difficult.

Waterlevel Drawdown*

Lowering the pond's water level and exposing all or much of the pond bed to air can have several favorable effects and may cost little. Many kinds of aquatic plants will be killed by drying. It is preferable to

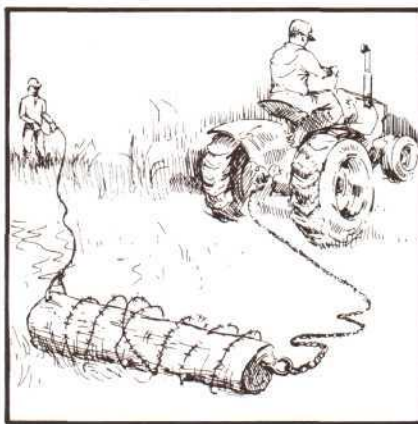

A log-and-barbed wire drag for removing vegetation.

do the drawdown in winter when the freezing of plant tissues, including perhaps the roots, will give even more extensive and lasting kill. Summer drawdown is particularly ineffective on plants such as coontail and elodea which grow as free-floating fragments. Still other plants increase as a result of summer drawdown. Summer drawdown seems actually to stimulate cattails. Winter drawdown does not adversely affect wild rice, a plant sometimes desired at the pond edge.

Where sediments are soft organic material, drying consolidates them, and several inches or feet of pond depth may be gained. Drawdown can also facilitate dredging.

For ponds formed by dams of proper design, draining is especially easy. In dug ponds, pumping is needed. Low-head, high volume pumps of relatively cheap operation can usually be used, as the water need not be lifted far. Pumps capable of draining ponds at least as large as 12 acres and 15 feet deep are available through contractors. In addition to mobile pumps especially designed for drainage, some people have, for small ponds, used old fire engines. It is also possible to make low-head pumps from outboard motors.

A word of caution: If shallow water is left for many days of the growing season in parts of the pond previously too deep for rooted plants, then the newly lighted environment may allow seeds or plant fragments to sprout and take root there. Upon refilling the pond,

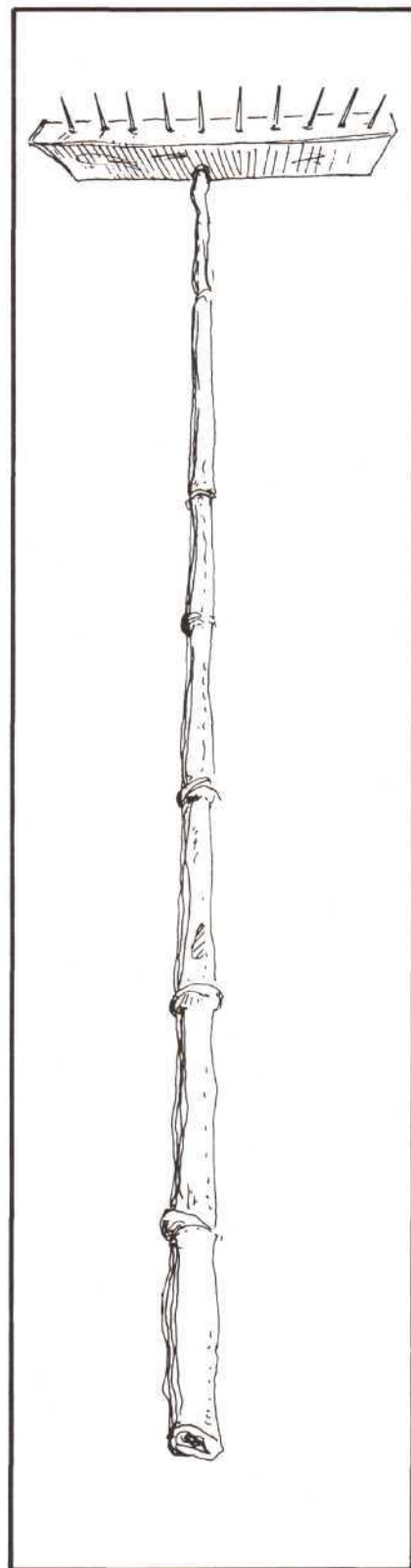

A floating rake.

especially if the water level is raised too slowly, the plants may grow upward into the normally lighted zone and become a nuisance. To prevent

*Contact nearest DNR office (Appendix) to secure permit for this procedure.

this, draw the water down as far as possible, and when the drying and/or freezing has had its effect, raise water level as rapidly as possible. If plants have begun to grow in the shallow drawdown pool, it may be well to destroy them by raking or other means before refilling the pond.

To avoid fish kills caused by low dissolved oxygen levels, special caution is advised when using drawdown.

Selective Discharge*

In a pond formed by a dam, designing the outlet facilities so as to vary the depth from which water is released may help control water fertility. At certain times of the year when dissolved nutrients are concentrated at certain levels, discharge water can be drawn from those depths to reduce the pond's total nutrient load. Possible adverse effects of nutrient-rich discharge on downstream waters should be considered.

Pond Flushing and Dilution*

It is sometimes thought that removing nutrient-rich pond water and replacing it with "sterile" water—or simply diluting it—will alleviate algal blooms and other plant problems. If truly nutrient-poor water is available from a well or elsewhere, this might be possible. But the effects would likely be brief if nutrients occur in shallow muds where rooted plants can use them or if nutrients flow from land—which is what probably caused the problem in the first place. Also, it is often believed that diverting "clean" stream water through a pond will keep nutrient levels low. Although nutrient concentration in the stream may be relatively low (not always the case!), the net effect is to deposit nutrients in the pond. The water slows down and the pond acts as a physical and biological trap.

Phosphorus Inactivation/Precipitation*

Introducing certain chemicals can change dissolved phosphorus to forms less available to plants or can entrap it and carry it down to the pond bed. The effect may be brief,

as described in the section on pond flushing. Various compounds of aluminum, iron, calcium and other elements can be used. The chemicals are typically broadcast as a powder or injected as a slurry into outboard motor wash. Aluminate and alum, used in combination, may be available to the pond owner, as may zeolite, fly ash, powdered cement and clay. Before using these materials, consult with a limnologist who understands the effects and possible pitfalls of using these materials. Hire a licensed applicator.

Pond Aeration

Pumping air into the depths of a pond and creating a rising stream of bubbles, will help aerate a pond. This is done by an on-shore compressor which passes air through a hose to the deepest part of the pond where a special dispenser, such as an air stone, plastic foam block or metal baffle, breaks it into fine bubbles. The rising bubbles draw water upward, causing the pond water to circulate from bottom to top and take on oxygen from the atmosphere. More oxygen is gained through the pond surface than from the stream of bubbles. With the water of the pond bottom oxygenated, the surface of the pond mud is kept oxidized, holding phosphorus in an insoluble form and less available for growing plants.

In the case of deep trout ponds, there is special equipment (hypolimnetic aerators) for circulating cool water of the deep zone to the surface and back during summer without mixing it with the upper layers. This avoids detrimentally warming the depths.

It may be especially important to aerate the pond in winter. This keeps an area ice-free and allows continual movement of oxygen from the atmosphere into the depths of the pond. It also reduces transfer of phosphorus from mud to water which occurs during winter stagnation.

Pondbed Sealing and Blanketing*

The pond bed can be covered with black plastic sheeting weighted with a gravel layer. Use a rake or pitch-

fork to puncture the sheet first with many small holes to allow escape of gas formed under it, otherwise the plastic may balloon up through the sand and gravel. The sheet makes mud nutrients less available to plant roots. You can also use a 6- to 8-inch layer of sand or gravel alone to cover organic sediments. This has the disadvantage of decreasing valuable pond depth and appears to have less lasting effect than when used on a plastic sheet.

Shading or Coloring the Water

Sheets of black plastic supported by a floating wooden framework can be used to cover large sectors of pond surface. Such a covering is anchored in one spot for the 3-4 weeks needed to shade out plants beneath it, then moved to a new place. Shading with plastic is apparently effective on most submergent plants (except chara) but not on emergents. The device may be cumbersome and unsightly.

Special dyes are available (one with the trade name, Aquashade) which temporarily color the water so as to cut off light and control plants.

Herbicides and Algicides

Killing pond plants with toxic chemicals is another form of temporary chemical treatment. Substances toxic to algae are called **algicides**. Those for poisoning rooted, leafy water plants are **aquatic herbicides**. You may need a permit from the DNR to use herbicides and algicides in your pond. Only ponds that are under single-party ownership and that have no outlet are exempt from permits (see Chapter 15).

Chemical treatments have advantages of convenience, but the following drawbacks should be considered:

- Poisoning kills plants without removing them from the pond. After death, the material sinks, consuming oxygen, creating odors and releasing nutrients for new plant growth.
- The poisoned plants disappear only slowly from the treated area. One to several weeks

*Contact nearest DNR office (Appendix) to secure permit for this procedure.

may pass before the nuisance plant masses sink away.

- Since each herbicide kills several or many kinds of plants, beneficial species may be killed along with the nuisance plants.
- Localized treatment is difficult. Even ponds that appear placid have currents that can carry poison from a problem area to an area with plant beds that should be preserved.
- There is risk of harm to other life in the pond and surrounding area.

Due to increasing knowledge and concern about risks of toxic chemical use, various products have been prohibited by State and Federal authorities. The list of permissible substances is much shorter now than a few years ago. Full consideration of other alternatives in aquatic plant control is advised before resorting to chemical treatment.

To use plant poisons effectively and with least hazard to other life, the kind of plant must be identified, the proper chemical obtained, the volume of the pond calculated, and the proper dosage applied. A list of chemicals presently allowed in Michigan for pond vegetation control and the plants they control can be obtained from your county Extension Office or from the MDNR Inland Lake Management Unit, Land and Water Management Division, Box 30028, Lansing, MI 48909. You should obtain an updated copy of this list each spring since the recommendations can change. Using chemicals other than on this list may be illegal and dangerous! Only use chemicals labeled for use in lake and ponds so you have complete instructions on their use and any special precautions to take when applying the chemical to water for weed control.

Dosage rates will be shown on the product label. These should be closely followed. **Do not overtreat!** Avoid the idea that "if a teaspoonful is called for, then a whole shovelfull will do the job better." This not only wastes money, but may cause plant decay so rapid that dissolved oxygen is depleted and fish suffocate—or the chemical overdose may poison fish and other life. Distribute the chemical evenly

over the area to be treated, whether using spray, powder or granular plant poisons. Too much applied in one place increases the risk of killing fish and other organisms. Most plant poisons work best when water temperature is above 65°F (18°C).

Carefully follow safety precautions printed on the product label. Don't let the chemical reach crops and other desirable plants or trees. Choose a calm day for treatment in order to avoid wind drift. Don't use the treated water for irrigation, agricultural sprays, livestock watering or swimming until a period has elapsed as advised on the label. Recommended waiting periods before various pond uses are included with the annual list of approved chemicals available from the county Extension offices or the MDNR. Don't eat fish from the pond for 3 days after treatment, or longer if stated on the label. Bathe and change clothes following use. In case of contact, immediately flush skin or eyes with much water for at least 15 minutes. Call a doctor immediately and have the chemical label with you for quick reference. Thoroughly wash spray equipment after each use. Dispose of all empty containers and clean up all spills. Take care that insecticide contamination of the pond does not occur from previous use of the sprayer for insect control.

Copper sulfate has been widely used to kill algae and is commonly available from agricultural supply outlets which sell it for other purposes. They generally don't provide instructions for its use as an algicide. No copper sulfate or other copper-based chemicals should ever be used in trout ponds. Neither should copper sulfate be applied extensively in other fishing ponds, even though it is frequently described as suitable for use in human drinking water supplies or where fish will be consumed. The high copper content can harm fish food organisms and fish reproduction. Copper sulfate is difficult to use properly. Its effects vary greatly depending on water hardness and other factors. In extremely softwater ponds, very little copper sulfate may kill the algae—but also kill the fish. In a very hard water situation, it may take much more copper sulfate to kill the algae, yet the danger to fish may be much

less. See your nearest DNR biologist for locally recommended dosages.

Copper sulfate is best applied by dissolving the crystals in water and spraying on the surface or by placing them in a burlap bag and pulling it through the pond until dissolved. Simply throwing copper sulfate crystals into the water results in accumulations on the bottom where it may poison fish food organisms while having little effect on the algal problem.

If you wish to poison algae with copper, the risk may be lowered somewhat by using **chelated copper**. It is available as a product (trade-name "Cutrine") well-labeled with instructions for use, and it achieves the same algicidal effect as copper sulfate with a much lower concentration of copper. This is less likely to harm fish and other pond life.

Chara algae can be particularly hard to control with toxic chemicals, because it often has a crust of lime (calcium carbonate or "scale"). Therefore chara should be chemically treated only in the spring before a heavy crust forms. Copper sulfate is not advised for control of chara. The amount needed to kill this plant would be hazardous to other pond life. Cutrine and Hydrathol 47 may be more effective on chara.

Biological Control

Controlling aquatic vegetation with plant disease organisms or by plant-eating fish, waterfowl or other animals has been tried in many parts of the world but holds little promise at present for Michigan conditions. The plant-eating Asiatic grass carp (*Ctenopharyngodon idella*), euphemistically called "white amur" by its promoters, has recently been imported into the U.S. South to control weeds in fish ponds. In addition to eating problem plants, it eats beneficial plants that are used as breeding habitat for pike and muskies, that serve as cover for young gamefishes and that are food for wildlife, especially waterfowl. Since the grass carp will not eat all aquatic plants and algae, the plants it won't eat will grow in place of the plants that it will eat. Considering the damage the common carp has caused in the 100 years it has been in North America, the possible bad

effects of the grass carp in Michigan are cause for great caution in its use. **It is illegal to bring grass carp into Michigan or to possess them here, including the sterile triploid grass carp.**

Plant-eating waterfowl have also been tried for controlling leafy aquatic plants. One pair of domesticated swans and their one or two offspring can keep an acre of pond

free of such plants. However, the swans must be provided with some open water and shelter in winter (or kept in a barn), and they may then need supplemental feeding which adds nutrients to the pond.

Ducks and geese that eat plants aren't suitable for pond weed control. They obtain much food through supplemental feed or by

foraging outside the pond, bring the nutrients to the pond as feces, and increase the plant problem.

Algae typically replace the higher aquatic plants consumed by animals used to control pond plants. In some cases, dense blooms of planktonic algae may be more tolerable than large weeds.

Controlling Animal Nuisances

While most wild mammals, birds, reptiles and invertebrate animals are beneficial, at times some of them conflict with people's interests, and control is needed. Don't expect animal damage control to be 100 percent effective or permanent. The controls described here will reduce or eliminate nuisances, but may have to be repeated.

Federal, state, and local laws bear on many control methods. **Check with local or state law enforcement officers about regulations and permit requirements.** For details on bird and mammal damage control beyond the brief information below, get leaflets in the "Vertebrate Pest Control" series from the Michigan State University Cooperative Extension Service.

Muskrats and Woodchucks

Muskrats and woodchucks dig burrows that cause pond bank cave-ins, may weaken dams or result in leaks. They prefer to dig in steep banks. Muskrats burrow from beneath the pond surface, while woodchucks typically tunnel into the downstream side of dams.

Muskrats make burrow entrances 6 to 18 inches below water line, sometimes deeper. Burrows may penetrate 9 feet or more, but average length is 5 to 6 feet. The tunnel leads to a dry nest chamber above water level.

Trapping and shooting are ways of controlling muskrats and woodchucks, but burrow fumigants are legal only for woodchucks. Keeping earthen dams mowed reduces cover that woodchucks and muskrats like.

Removing cattails, arrowhead, and other emergent plants deprives muskrats of food and cover. Armoring the shore with rock and other hard materials will discourage burrowing.

Controlling a muskrat population is usually feasible only if the pond is far from other muskrat habitat. If near other waterways or wetlands, muskrats will continually move in. In such cases, it may be better to **control the damage** by reinforcing the embankments rather than trying to control the muskrats.

Trapping Muskrats

Muskrats are easily trapped. In the legal trapping season, no license is needed to trap on your own land, and the pelts will then be prime and bring top prices. If you get a state permit to trap for damage control, you may kill muskrats at any time and with kinds of traps that would otherwise be illegal. See a DNR conservation officer for additional information.

Without a special permit, you may, in Michigan's trapping season, use bait sets, slide sets, float sets, or under-ice sets. Fasten traps to stakes set in deep water so muskrats quickly drown and don't twist or gnaw feet off and escape. No trap may be set within 6 feet of a muskrat house, hole, or home. Only steel leg-hold or body-gripping traps may be used. Traps must have a jaw-spread of 5 inches or less. Traps in use or in the user's possession afield must have an attached metal tag bearing the trapper's name and address.

With a special state permit for muskrat control on your own land, the distance rule doesn't apply, and you may also use "repeater trap"



tubes in the burrows that catch many muskrats at one setting.

Armoring the Shore

The pond shore can be reinforced to deter muskrat burrowing in one of the following ways:

- Line with a foot-thick layer of rocks (called riprap) at least 6 inches in diameter from 3 feet below the *low* water line to one foot above the *normal* water line.
- Use soil cement in the top 6 inches of earth from a foot above normal water level to 4 feet below low water line.
- Line with chicken wire or hardware cloth of 2-inch mesh or less from slightly above normal water line to 3 feet below low water level.

Repellents and Poisons

Repellents aren't effective against muskrats, but poisoned baits can be used. Contact a U.S. Fish and Wildlife Service agent for instructions. Permits to poison muskrats must be obtained from the Michigan DNR.

Moles

Mole burrows can destroy patches of sod on dams or pond banks resulting in erosion. Control by trapping, burrow fumigants, or EPA-registered soil insecticides. Apply traps and fumigants to burrows that are in active use. To see if a burrow is active, gently flatten it. If in use, the ridge will be raised again within 24-40 hours. Applying soil insecticides kills the food supply of the moles.

Birds

Several kinds of fish-eating birds may reduce fish populations in ponds. Kingfishers, large herons, mergansers, and domestic muskovo ducks are notable predators. All of these can be scared away by noise-making devices, such as gas exploders and "scare" shotgun shells. To use these devices requires a federal permit. Exploders must be moved often and the firing interval changed, or birds become accustomed to the noise.

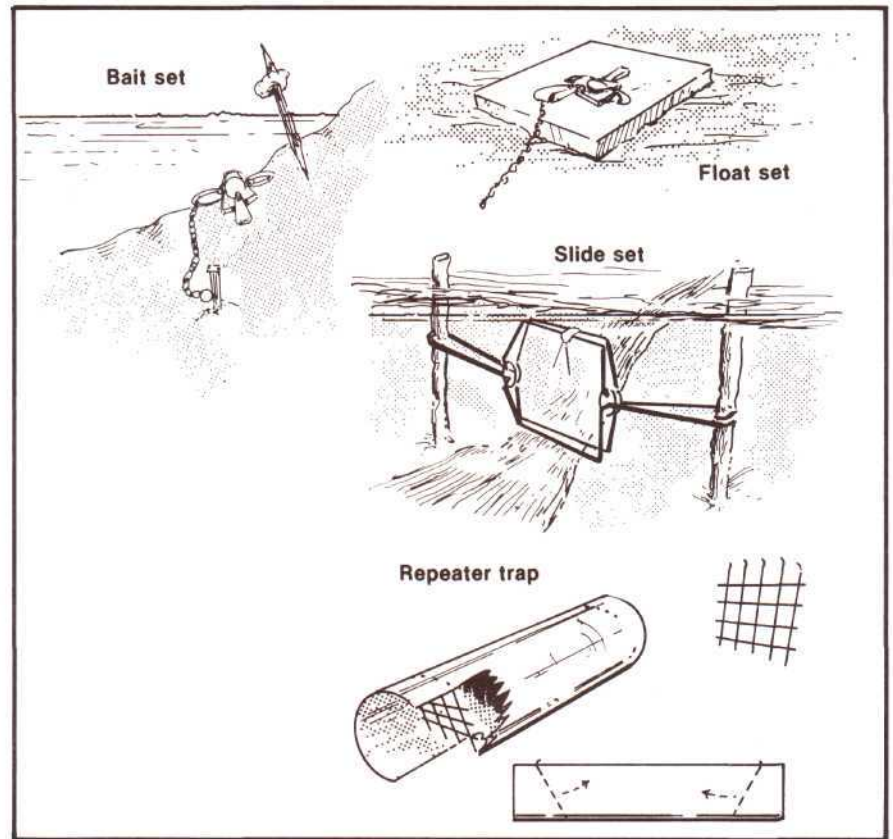

Various types of trap sets for removing muskrats and woodchucks.

Most effective in many cases are 12-gauge shotgun "scare" shells that detonate in the air near the birds. They have especially great effect when used in conjunction with gas exploders. They may be the only way to deal with herons and mergansers.

Floppy scarecrows, large rubber snakes, and owl or hawk decoys can also be used to scare birds away. They must be positioned imaginatively and moved often.

Discourage herons by deepening pond edges to form rather steep underwater side slopes. Three feet of horizontal distance per foot of drop is the maximum slope recommended for safety. It may also work (but be unsightly) to erect wire strand fencing or lengths of chicken wire along shallower parts of the pond edge.

Discourage kingfishers by removing all perches such as posts and dead tree limbs close to the pond. If muskovo ducks are kept at the pond, confine them to a small part of it.

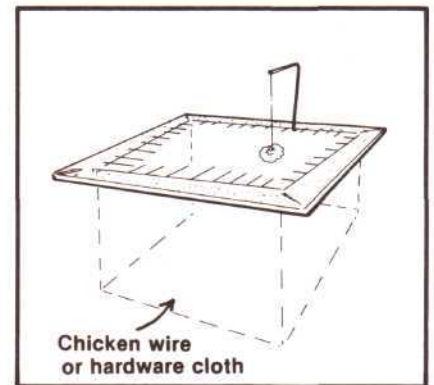

Turtle trap.

Herons and other migratory birds are protected by federal law. Contact a U.S. Fish and Wildlife Service agent about regulations.

Turtles

Turtles often eat fish and fish eggs. They can also steal bait from hooks and fish from stringers. Snapping turtles are especially voracious fish predators.

One common way of catching turtles is to set No. 4 steel traps in shallow, weedy areas, or to nail them on posts at or just above water line. These are baited with fish, fish heads, chicken entrails, watermelon rind, or meat wired to the trigger. A bad problem with this method is that the traps also catch ducks and other desirable—or even protected—animals.

There are other methods which are effective on turtles but safer for other wildlife. Floating turtle traps are one. These have a wire or net cage suspended below a square wooden frame with spikes pointing inward from the frame's inner edge. Turtles fall in when they reach for bait hung above the trap or when they tip a board balanced on the edge. Another trap is the so-called bob-funnel.

A set line having a treble hook baited with materials previously listed may be used if a state permit is obtained. For best results, attach set lines to limber poles driven into the pond bank. Turtles often break set lines attached to firm objects.

When you catch turtles, don't throw them away. They're delicious.

Snakes

Sometimes fish-eating water snakes take up residence near a pond, and most often when a stream is nearby. Water snakes usually pose problems only for trout and minnows.

Mowing pondbank vegetation and removing logs, tree roots, branches, and large stones from the shoreline reduces habitat for water snakes. The mowing, however, will eliminate the advantages of having a vegetational buffer strip to filter nutrients and silt out of runoff water. Persistent killing can reduce watersnake populations.

Swimmer's Itch

Swimmer's itch is caused by a minute free-swimming parasite that burrows into and irritates the skin. This parasite develops only in certain kinds of snails before it attacks humans.

Ridding a pond of swimmer's itch means controlling the snails. To control snails with least harm to the pond's fish, remove plants and pondbed debris. These are the snails' habitat. Sowing pea-sized copper sulfate crystals onto the pond bed (2 lb/1000 sq ft or 87 lb/acre) poisons snails—but also kills many other fish food organisms, and possibly some fish, especially trout.

Mosquitoes

Mosquitoes don't generally thrive in fish ponds. If much of a fish population exists, the mosquito larvae will be eaten. Moreover, mosquitoes need calm water surfaces for development. Any parts of a pond that wind ripples will be unsuitable. Only very shallow, protected pond edges will support them. Small fish usually dispose of most larvae in these places.

Most kinds of mosquitoes that cause problems for people come from temporary puddles that lack fish. Keeping a stable pond water level prevents the frequent flooding of shoreland which would make isolated puddles for mosquito breeding. Don't try to control mosquito breeding unless you have found exactly where they're breeding. Then confine control efforts to those sites.

Beware of using insecticides near ponds to control mosquitoes. These chemicals are very likely to kill the fish.

A safe, effective, and pleasant mosquito control is to install a purple martin house near the pond or at the area of human activity. One colony of martins will usually keep mosquitoes at a tolerable level during daytime and early evening.

Another biologic way to control mosquitoes is with gambusia fish. These small warm-climate fish can be stocked in marshes, swales and seasonal puddles where our native mosquito-eating fishes are frozen out in winter. Gambusia also die in cold weather, but it's easy to recapture a few and keep them indoors during the winter, then stock them again in late spring. A few in each separate water area will multiply

fast and keep mosquito larvae cropped down.

Leeches (Bloodsuckers)

Michigan has about 50 species of leeches, of which only four attach to humans. Most kinds of leeches feed on other animals, such as turtles, or on dead matter. Therefore, the first thing to determine is whether leeches are attaching themselves to people—or whether leeches have merely been sighted in the water. No control is needed unless the leeches are definitely causing a problem.

Often, the most effective way to reduce leech populations is to reduce the amount of organic debris on the pond bed. Leeches dwell in accumulations of twigs and leaves at the bottom of the pond and swim up or reach out to attach to host animals. Some leeches attach to aquatic plants and stretch to amazing lengths in search of passing food. Preventing or controlling beds of dense vegetation may also help to control leeches.

Another method for controlling leeches is to have plenty of bass in the pond—or trout, if it is a cold-water pond. Such fishes are avid predators on most of the troublesome leeches. In fact, some kinds of leeches are highly effective fishing baits, and they are a hot-selling item at bait shops. Stocking 25 to 50 yearling (6-8-inch) bass per acre should reduce leech populations so that they are no longer a problem.

Leeches are subject to poisoning with copper sulfate (CuSO_4)*, but this method is generally unsuccessful in ponds for a number of reasons. A tremendously heavy dosage is needed—3 pounds of granular copper sulfate applied to each 100 square feet of pond bed. This is supposed to form a bottom layer of water which contains 40 parts per million dissolved CuSO_4 , toxic to leeches—and probably to all other bottom-dwelling fish food, as well. A major problem with this procedure is that leeches are good swimmers and can move upward to escape the poisonous layer.

Never use CuSO_4 in a trout pond!

*Contact nearest DNR office (Appendix) to secure permit for this procedure.

Fish Parasites and Diseases

It's normal for pond fish to have parasites such as grubs, or worms on or in the skin, attached to the gills, within the gut, or embedded in the flesh. No fish parasites in Michigan pose a threat to human health if the fish is cooked thoroughly before being eaten. Neither should the parasites affect flavor of the fish. The sight of them may be unappetizing, but few of the many fish parasites are detected by most people during cleaning, cooking and eating.

Parasites may be especially numerous on fish that live in shallow, weedy ponds. Fish from

deep ponds with few weeds generally have fewer parasites. Many of the parasites that infest fish live part of their lives in host animals, such as clams and snails, that dwell in shallow water or on plants. Because there are so many kinds of these intermediate hosts, it's impractical to try to control fish parasites in most ponds—other than by making the pond deeper and less weedy.

Some of the more common kinds of fish parasites are: threadworms, spiny-headed worms, tapeworms, anchorworms, flukes, fish lice or gill lice, leeches, lamprey, and various microscopic organisms. The

Table 12-1. Common Fish Diseases and Their Symptoms

Name of disease (and fishes affected)	Causative agent	Symptoms
Skin fungus or water mold (all fishes)	Saprolegnia fungus (often results from injury to skin)	Tufted growths of fine white or gray threads radiating 1/3 inch or more from body.
Columnaris (all fishes)	<i>Chondrococcus</i> <i>columnaris</i> bacterium	Grayish-white spots surrounded by red on parts of head, gills, fins or body.
Red sore (northern pike)	<i>Aeromonas liquefaciens</i> bacterium	Open bleeding sores from which scales are lost.
Furunculosis (trout and salmon)	<i>Aeromonas salmonicida</i> bacterium	Boils or furuncles on skin, in- flammation of inner body walls, many small internal hemor- rhages, bright red spleen and swollen kidneys.
Black spot or black grub (mostly warmwater fishes*)	strigeoid trematodes	Small black spots just under skin and in muscle. These are cysts containing a microscopic stage of this fluke.
"Ich" or white spot (mostly warmwater fishes)	<i>Ichthyophthirius</i> <i>multifiliis</i> protozoan	Tiny white spots on body.
Lymphocystis (perch, walleye, sunfishes)	a virus	Raised nodular masses of light- colored tissue resembling warts on skin.
Tumors and other deformities (all fishes)	Injuries, dietary problems, genetic causes, etc.	External and internal tumors of various sorts, spinal defor- mities, shortened or flattened heads.

*Also trout where the water is unfavorably warm.

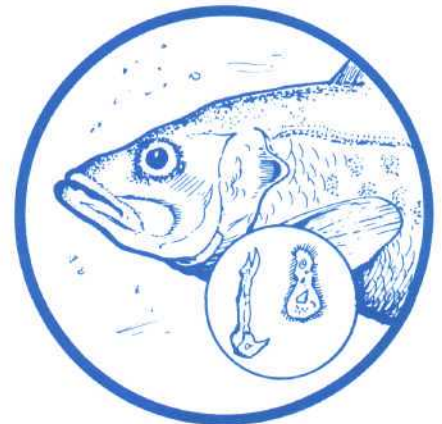

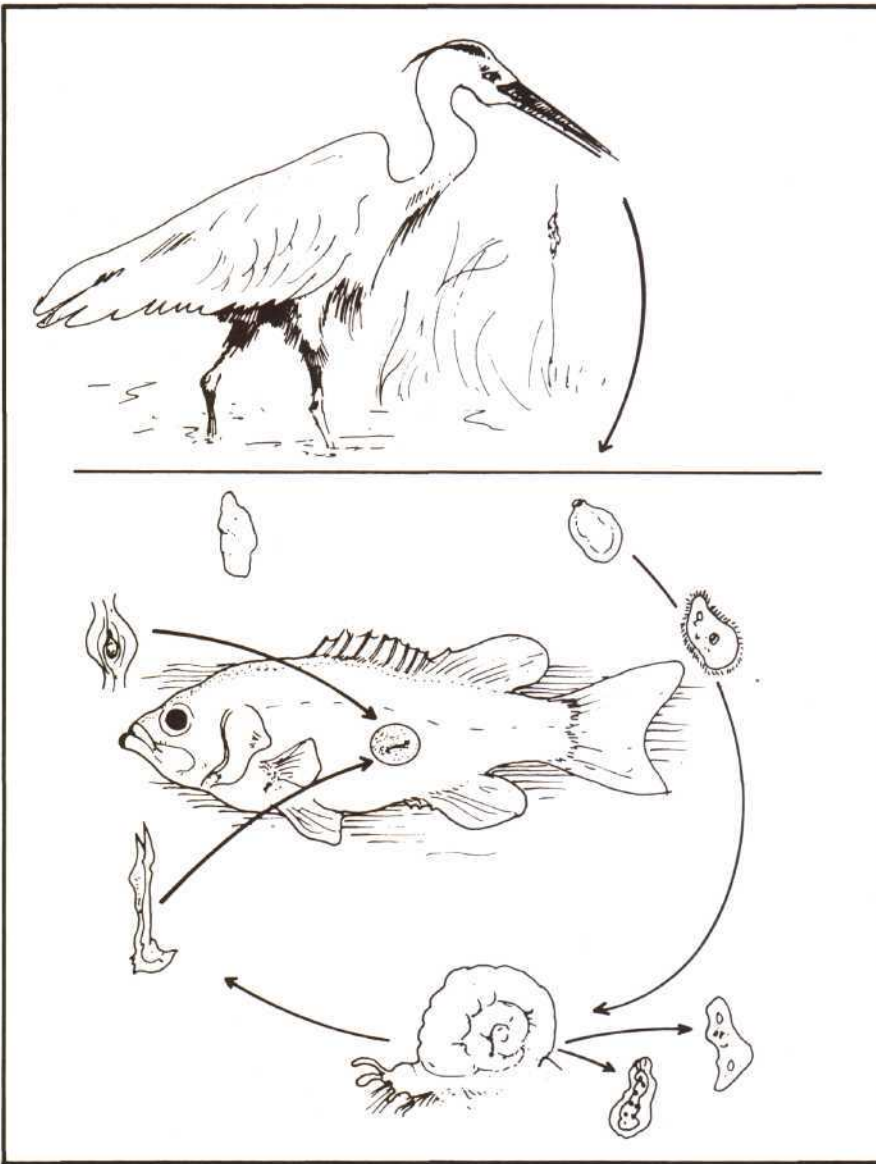

Life cycle of the yellow grub.

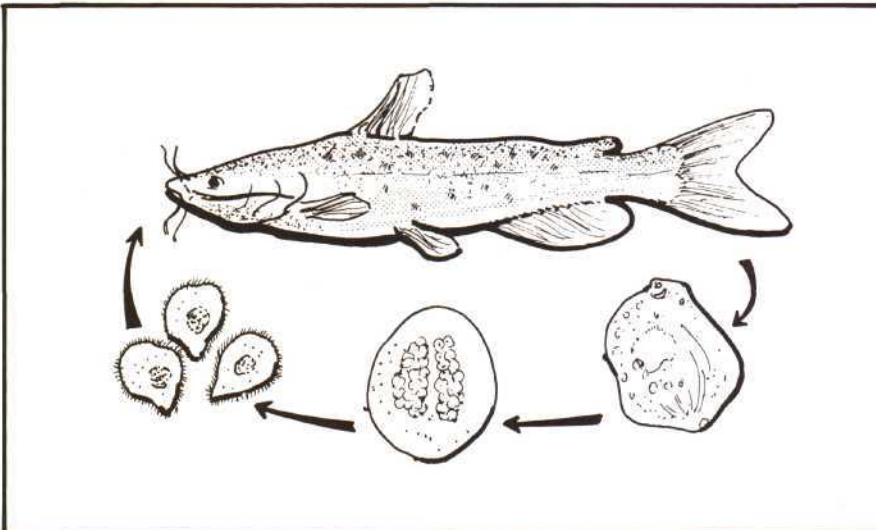

Life cycle of the "ich" skin parasite.

broad tapeworm of man, infrequently found in fish from a few waters in Michigan's Western Upper Peninsula, is the only real threat to humans—but again, only in cases of inadequate cooking.

Aside from effects of parasites on the appearance of fish flesh, some parasites and diseases can severely hamper fish growth and survival. This is most likely to be a problem where fish are crowded, as in trout ponds where the number of fish is kept unnaturally high by heavy stocking and supplemental feeding. Disease is also more likely to occur when the fish are stressed by unfavorable temperature, low oxygen supply, or other water quality problems.

Common diseases of Michigan fishes are listed in Table 12-1. If the symptoms described there are noted, or if abnormal numbers of dead fish occur, contact a private fisheries consultant for positive identification and proper treatment. See the Appendix for information on private consultants. Disease or parasite identification and treatment recommendations can also be obtained for a fee by sending specimens of the fish to the Michigan State University Animal Diagnostic Laboratory (East Lansing 48824).

Pond owners should carefully examine fish they intend to stock. If the fish show signs of distress, parasites or disease, don't stock them. They may be a poor investment and may infest other fish in the pond. A fish breeder or dealer who delivers diseased fish for stocking should be instructed to keep and treat all fish or destroy them. Under no circumstances should diseased fish be stocked into public waters. In fact, for this very reason, no fish should be stocked in public waters without a state permit

Managing Ponds For Profit

Ponds can be managed for profit by:

- **Fish farming or “aquaculture”**—raising fish to sell for human food, for stocking of other people’s ponds, or for use as fishing bait.
- **Fee-fishing pond operation**—having anglers pay to fish in ponds.

Prospects for profit are generally poor in Michigan for either type of operation, unless the site is exceptionally good, a large investment is made in facilities, and the operator has special training and experience. There are less than 100 fish farming operations in Michigan, and most of them are unprofitable.

Rainbow trout and, to a lesser extent, brook trout are the only fishes that grow fast enough in Michigan ponds that they can be raised for human food. However, trout can be raised much more efficiently in some other states where spring water supplies are better. It is hard for Michigan trout farmers to compete with their prices.

The situation is even worse with catfish farming which has recently become so popular in the South. While catfish grow to marketable size in one summer in the warm southern states, they need three summers to reach the same size in Michigan. Therefore, no catfish are reared for the restaurant trade in Michigan.

It is possible, however, to profitably raise certain warmwater fishes, as well as trout, to sell to pond owners for stocking. This is because prices for live fish delivered for stocking are much higher than for food market fish.

For trout farming, not only must

there be large supplies of high-quality spring water, but ponds and other facilities must be especially designed for efficient operation. Fish-farming ponds are usually built much differently than family fishing ponds. This entails enormous expense, as does paying qualified personnel. A fish farm may not begin to show a profit until 5-10 years after it is built.

To be successful, the operator has to know a great deal about fish nutrition, disease diagnosis and treatment, genetics of fish breeding, fish transport, fish processing, and fish marketing. Having a graduate fishery biologist with special training in fish culture is almost essential to compete in this business now.

Baitfish rearing isn’t done very much in Michigan anymore. Special conditions of climate and water supplies in Arkansas, Minnesota, and the Dakotas make baitfish production much more efficient there. Breeders in those states transport baitfish to Michigan dealers at prices our producers find hard to meet.

Fee-fishing ponds can use several kinds of fish, depending largely on pond temperature, kinds of fish available from suppliers, and what kinds of fish the customers like to fish for. In most areas, trout are the most popular and the easiest to obtain and manage. Some fee-fishing operations raise their own fish, but most stock with fish bought from fish farmers. It is best to be located near a large population center, in a popular tourist area, or on busy travel routes.

In the case of either fish raising or fee-fishery operation, there are often water quality problems caused



by the artificial feeding that must be done. Waste feed and fish feces accumulate on the pond bed and must be periodically cleaned out. Therefore, the ponds must be designed for draining and with other features to

aid in cleaning. Even then, removal of wastes can be a major project.

Whatever the type of fish-farming or fee-fishing enterprise, a state permit is needed in Michigan. Contact the DNR Fisheries Division early in

the planning stage to see what regulations apply to the proposed operation. See Appendix for a list of DNR offices.

Pond Safety And Liability

A fishing pond may also furnish some swimming, boating, hunting, ice skating, wading, and picnicking, although it may be designed to make it best for fish and without ideal features for other uses. It will be a special attraction to children.

Because a pond attracts people, it presents an accident hazard. Drownings are second only to motor-vehicle mishaps as a cause of accidental death among people in the active age groups, particularly children.

Each pond owner has moral and legal obligations to family, friends, neighbors, and even trespassers to make the pond as safe as possible. Providing certain safeguards can prevent an incident from becoming an accident or even a fatality. **Simply posting a pond against trespass doesn't relieve the owner of responsibilities.** Legal liability is often based on whether the owner has taken **all reasonable precautions** against mishaps. **A pond owner should consult his or her attorney and insurance company** about liability for serious accident or death and about legal requirements for safety precautions at the pond.

Find out what both community and state liability laws are for injury or death resulting from use of the pond. Local laws may vary greatly. This is especially important if the owner intends to open the pond to the public and charge a user fee.

Here is a list of fairly economical safety measures:

- Grade the pond bed to eliminate steep slopes or drop-offs.
- Remove stumps, logs, large rocks, and trash that could pose a hazard to waders, swimmers, and boats. Broken

glass and other sharp objects are especially to be eliminated.

- Place warning signs near specific danger areas, telling water depth and location of nearest telephone.
- If there is to be swimming, mark a safe special area for it with buoyed lines.
- Install life-saving equipment on the pond bank where it can be easily seen and used.
- Be sure that piers, rafts, and landings are well-constructed and braced.
- Erect adequate fencing and gate with lock to prevent unauthorized entry, especially by children.
- Keep boats used on the pond in good condition. Never overload them. Instruct passengers never to stand up in the boat. Provide one Coast Guard approved life preserver for each person on board. Use common-sense boat safety in all other respects!
- Beware of thin ice! Test ice strength with a spud or auger, and actually measure ice thickness before venturing over deep water. Don't walk or skate on freshly-formed ice that is less than three inches thick. If ice is thawing, it may have to be much thicker than that. Snowmobiles shouldn't be driven onto ice less than five inches thick.
- Keep a wooden ladder at the pond edge in winter. This can be shoved to someone who has fallen through the ice.
- Never let a child play at the pond alone, no matter what the season.



— Everyone who lives, works, or plays near a pond should know how to swim and how to give artificial respiration. Find out more about it from your local Red Cross organization.

Follow these steps to install a rescue station:

1. **POST**—a 6-ft two-by-four or four-by-four, preferably painted yellow. Set post about 2 ft into ground, standing no more than 4 ft out of ground, near water at any point where swimmers might get into trouble. Paint “**THINK, THEN ACT**” down length of post on all sides. About 1 ft from top of post, attach metal shelf bracket, wooden arm, or 60-penny spike as hook for coiled rope and jug float.

2. **JUG**—a gallon plastic jug with an inch of water inside for throwing. Paint “**FOR EMERGENCY USE ONLY**” on side.

3. **LINE**—a 40-ft length of plastic-coated clothesline. Tie one end to handle of plastic jug. At opposite end, fasten a 4-inch piece of two-by-four to prevent line from slipping completely through hands or from underfoot when thrown.

4. **POLE**—a 10-ft or 12-ft bamboo pole or sapling. Since pole will be used to extend to anyone struggling in water, tip and butt should be wrapped with friction tape to reduce slippage. Paint pole white. Hold pole in upright position by placing it in two 6-ounce tin cans, nailed near bottom of the post about 6 inches apart.

5. **TIN CONTAINER**—a 46-ounce juice can or a 2- or 3-lb coffee can. Remove one end, then slide can over top of post. Fasten down with one nail through center of top so it is possible to rotate and read the poster described below.

6. **POSTER**—a sheet of safety tips, rescue methods, and emergency telephone numbers. After applying a coat of spar varnish to can, attach poster to can and mount can at top of post. Let dry thoroughly, then varnish poster to protect against weather.

Note: Add a ladder to the rescue station, if the pond is likely to be used in winter.

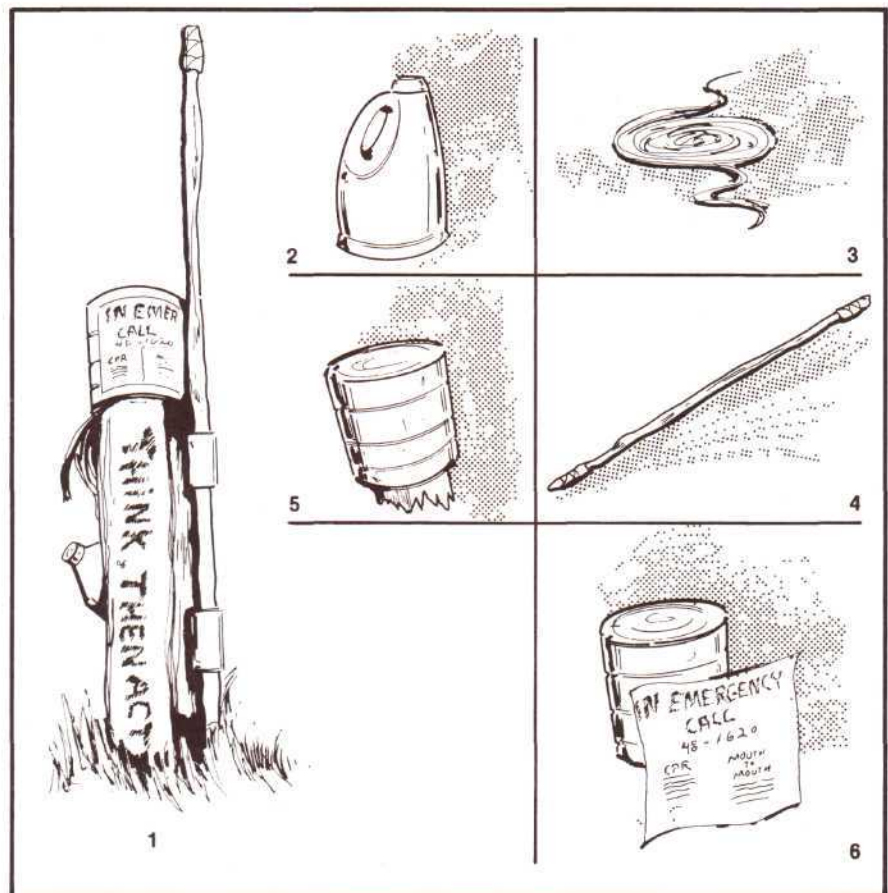

Steps in making a rescue station.

State Regulations On Pond Building And Management In Michigan

The Michigan Department of Natural Resources (MDNR) actively regulates pond construction and management. The basic areas of regulation and the statutes which apply are outlined below.

Pond Construction

Because dams and other potential environmentally damaging practices such as dredging channels and filling marshes have become so widespread, laws have been enacted to regulate these activities. Three principal statutes are:

- **Act 346—The Inland Lakes and Streams Act of 1972.** This requires an MDNR permit for dredging or filling to create any canal, channel, ditch, lagoon, *pond*, or lake within 500 feet of the ordinary high-water mark of an existing lake or stream. PL 566 projects and some county drain projects are exempted. The application fee is \$25.
- **Act 204—The Dam Act of 1971 (Dam Construction Approval Act).** This act requires an MDNR permit for all dam construction when the structure impounds more than five acres or has a head of five feet or more. Dams designed by the U.S. Soil Conservation Service are exempted, *but dam building on any permanent stream, no matter how small the dam or impoundment, still requires a permit under Act 346.* Application fees under Act 204 range from \$200 to

\$600, depending on height of head. Construction plans for such dams are required and must be prepared by a registered professional engineer.

- **Act 245—The Water Resources Act of 1929,** as amended. The Flood Plain Modification Section of this act regulates pond construction with respect to placing fill or structures in the flood plains of any rivers or streams. Application fees and engineer drawings are required.

Any pond built in violation of these laws or without the appropriate permit may be considered illegal. Civil action may be initiated by the MDNR with subsequent removal mandated by the court at the owner's expense.

Use of Chemicals to Control Pond Vegetation or Fish

Any use of chemicals to kill or control algae, weeds, or fish must be preceded with an MDNR permit when the water is public, is subject to fish migration from other waters at any time of year, or is connected with other water bodies by any water route. No chemical use permits are needed on ponds which are completely landlocked and under single-party ownership.

For details on use of chemicals to remove fish, ask for MDNR Fisheries Pamphlet No. 19.



Fish Stocking

An MDNR permit is required for fish stocking in public waters, in private waters having fish migration from public waters, and in private waters connected by any water route with bodies of water in other ownership. "Private" means that the pond is in single-party ownership. No stocking permits are needed in ponds which are completely landlocked and under single-party ownership.

A state license is also required for anyone who wishes to sell fish for stocking. This is called a "fish breeder's license." A seller of fish must have this license whether or not he or she is the actual breeder of the fish or just a dealer for fish that someone else has bred.

Tight regulation of fish selling and stocking is needed to control fish diseases and to prevent entry of certain kinds of fish into waters where they might be harmful. Importation of fish into Michigan from other states or Canada needs a further special permit.

For stocking the kind of pond that needs a fish stocking permit,

contact the nearest MDNR District Fishery Biologist (list in Appendix). There is no application fee. Apply at least a month in advance. Helpful advice on how best to stock the pond may be gained in the process.

Introducing Exotic Fish

Exotic is the term applied to kinds of fish not native to an area. Fishes exotic to Michigan may not be brought in **or possessed** here without a special permit from MDNR. No permits will be issued for importation of any exotic species until it has been proved that such an introduction would not cause harm. Much environmental degradation has been caused by exotics introduced in the past. The common carp is an example.

The recently much publicized Asiatic grass carp (white Amur) and various kinds of tilapia fishes are exotics often suggested as aids in pond weed control or food production. Present policy forbids issuance of permits for them. Their harmless-

ness hasn't been proved, and there is much reason to suspect that the grass carp would damage lake and pond habitat for fish, waterfowl, and other valued animals. Don't purchase or accept gifts of grass carp or other exotics.

Fishing Regulations

A current Michigan fishing license is required for all persons of 17 years or older when fishing on ponds that are public or have a connection through which fish may enter **from** public waters at some time of the year. In such ponds, statewide fishing seasons, size and creel limits apply.

In landlocked ponds with single ownership of the banks, statewide fishing laws don't apply, and no fishing license is needed. Anglers taking trout, bass, or other game or panfishes from such ponds during closed seasons or in numbers or sizes at variance with state law should obtain written verification that the fish were taken from private waters before transporting them on a public road or highway.

References for Further Reading

Pond Planning and Construction

Gibson, G. R., Jr. 1979. *A Riparian's Guide for Self-Help Inland Lake Water Quality Management*. Extension Bull. E-1117, Michigan State Univ., East Lansing. 67 pp.

U.S.D.A. Soil Conservation Service. 1973. *Building a Pond*. U.S. Dept. of Agriculture. Washington, D.C. 13 pp.

VanDusen, P., W.M. Marsh & T.E. Borton. Undated. *Planning and Management Guidelines for Inland Lake Property Owners*. Inland Lake Management Unit, Mich. Dept. Natural Resources, Lansing. 12 pp.

Life of Ponds—General

(Identification of organisms, biology, ecology.)

Amos, W. H. 1967. *The Life of the Pond*. McGraw-Hill Book Co., New York. 232 pp.

Brown, E. S. 1955. *Life in Fresh Water*. Oxford Univ. Press, London. 64 pp.

Coker, R. E. 1968. *Streams, Lakes, Ponds*. Harper & Row, New York. 327 pp.

Klots, E. B. 1966. *A New Field Book of Freshwater Life*. G. P. Putnam's Sons, New York. 398 pp.

Reid, G. K. 1967. *Pond Life: A Guide to Common Plants and Animals of North American Ponds and Lakes*. Golden Press, New York. 160 pp.

Ward, H. B., & G. C. Whipple. 1959. *Fresh-water Biology*. 2nd Edition (W. T. Edmondson, ed.). Wiley & Sons, New York. 1248 pp.

Identification of Fishes

Eddy, S. 1969. *How to Know the Freshwater Fishes*. Wm. C. Brown Publ., Dubuque. 286 pp.

Hubbs, C. L., & K. F. Lagler. 1964. *Fishes of the Great Lakes Region*. Univ. of Michigan Press, Ann Arbor.

Scott, W. B., & E. J. Crossman. 1973. *Freshwater Fishes of Canada*. Bull. 184, Fisheries Research Board of Canada, Ottawa. 966 pp.

Identification of Aquatic Invertebrates

Pennak, R. W. 1978. *Freshwater Invertebrates of the United States*. Wiley, New York. 803 pp.

See also various references under "Life of Ponds—General", above.

Identification of Aquatic Plants

Fassett, N. C. 1957. *A Manual of Aquatic Plants*. Univ. of Wis. Press, Madison. 405 pp.

Prescott, G. W. 1964. *How to Know the Freshwater Algae*. Wm. C. Brown Co., Dubuque. 348 pp.

Stodola, J. 1967. *Encyclopedia of Water Plants*. T. F. H. Publications, Neptune City, N.J. 368 pp.

Winterringer, C. G., & A. C. Lopinot. 1966. *Aquatic Plants of Illinois*. Illinois State Museum. 141 pp.

Nutrient Overenrichment and Aquatic Plant Problems/Control

Anonymous. 1978. *Aquatic Plants and Their Control*. Div. of Land

Resource Programs, Mich. Dept. Natural Resources, Lansing. 9 pp.

Dunst, R. C. et. al. 1974. *Survey of Lake Rehabilitation Techniques and Experiences*. Tech. Bull. 75, Wis. Dept. Natural Resources, Madison. 179 pp.

King, D. L. 1979. *Lake Eutrophication: Definition and Causes*. Pages 5-11 in "Inland Lake Eutrophication: Causes, Effects, and Remedies." Institute of Water Research, Michigan State Univ., East Lansing.

McNabb, C. D., Jr. 1977. *Aquatic Plant Problems in Recreational Lakes of Southern Michigan*. Extension Bull. E-1135, Michigan State Univ., East Lansing. 25 pp.

Nichols, S. A. 1974. *Mechanical and Habitat Manipulation for Aquatic Plant Management*. Tech. Bull. 77, Wis. Dept. Natural Resources, Madison. 34 pp.

Smith, S. A., D. R. Knauer & T. L. Wirth. 1975. *Aeration as a Lake Management Technique*. Tech. Bull. 87, Wis. Dept. Natural Resources, Madison. 39 pp.

Vallentyne, J. R. 1974. *The Algal Bowl: Lakes and Man*. Environment Canada Fisheries and Marine Service, Ottawa. 186 pp.

Pond Fishery Management

Bennett, G. W. 1971. *Management of Lakes and Ponds*. Van Nostrand Reinhold, New York. 375 pp.

Eipper, A. W., & H. A. Regier. 1962. *Fish Management in New York Farm Ponds*. Extension Bull. 1089. Cornell Univ., Ithaca.

Klingbiel, J. H., L. C. Stricker & O. J. Rongstad. 1972. *Wisconsin Farm Fish Ponds*. Univ. of Wisconsin Extension. Madison. 44 pp.

Lopinot, A. C. 1972. *Pond Fish and Fishing in Illinois*. Fishery Bull. No. 5, Illinois Dept. of Conservation, Springfield. 72 pp.

Marriage, L. D., A. E. Borell, & P. M. Schaefer. 1971. *Trout Ponds for Recreation*. Farmer's Bulletin No. 2249, U.S. Dept. of Agriculture Soil Conservation Service, Washington, D.C. 13 pp.

Novinger, G. D., & J. G. Dillard, eds. 1978. *New Approaches to the*

Management of Small Impoundments. Special Publ. No. 5, North Central Div. American Fisheries Society. 132 pp.

Pond Fishing

Cary, R. 1967. *How to Catch Fish in Fresh Water*. Fisherman's Information Bureau, 20 N. Wacker Dr., Chicago, Illinois. 31 pp.

Merwin, J., ed. 1980. *Stillwater*

Trout. Nick Lyons Books, Doubleday & Co., Garden City, N.Y.

Prospects for Aquaculture

Johnson, R. D. & D. R. Talhelm. 1978. *Profiles of Aquaculture in Michigan*. Mich. Sea Grant Program Tech. Bull. 61 (Ext. Bull. E1230), Mich. State Univ., East Lansing. 28 pp.

Appendices

District Offices of the Michigan Department of Natural Resources

Contact the nearest one regarding permits for the following pond management activities: **damming; pond digging or redredging** within 500 ft of any flowing water; **fish stocking; pond draining; use of algicides or weed-killing chemicals; use of fish toxicant chemicals; and aquatic weed cutting or harvest.**

1. Box 440
Baraga 49908
(906-353-6651)
2. P.O. Box 300
Crystal Falls 49920
(906-875-6622)
3. P.O. Box 495
Escanaba 49829
(906-786-2351)
4. P.O. Box 445
Newberry 49868
(906-293-5131)
5. Box 667
Gaylord 49735
(517-732-3541)
6. Box 629
Cadillac 49601
(616-775-9727)

7. Box 939
North M-33
Mio 48647
(517-826-3211)
8. 501 Hemlock
Clare 48617
(517-386-7991)
9. 6th Fl., State Off. Bldg.
350 Ottawa St., N.W.
Grand Rapids 49503
(616-456-5071)
10. P.O. Box 218
Imlay City 48444
(313-724-2015)
11. P.O. Box 355
Plainwell 49080
(616-685-6851)
12. 3335 Lansing Avenue
Jackson 49202
(517-784-3188)
13. 2455 N. Williams Lake Rd.
Pontiac 48054
(313-666-1500)

Michigan Cooperative Extension Service

Cooperative Extension Service county offices are listed in the phone book under your county government. They can provide a local source for additional copies of this bulletin and additional bulletins and information about ponds.

Sources of Fish for Stocking

Contact one of the above offices for a free list of licensed fish breeders.

Consulting Biologists for Private Pond Investigation and Management

List available from:
Extension Aquatic Program
Dept. Fisheries & Wildlife
Michigan State University
East Lansing, MI 48824
(Phone 517-355-7493)

Fish Disease Diagnosis and Prescriptions for Control

Animal Health Diagnostic
Laboratory
Michigan State University
East Lansing, MI 48824
(Phone 517-353-1683)

Aquatic Plant Control Permits

MDNR Inland Lake Management Unit
Land and Water Management Division
Box 30028
Lansing, MI 48909

Sources of Equipment and Supplies

(The listings below imply neither endorsement of products or services nor non-endorsement of firms, products or services not listed.)

Measurement Kits for Dissolved Oxygen, Alkalinity, and pH

Hach Company
Box 907, Ames, Iowa
(Phone 800-525-5940)

LaMotte Chemical Products
Chestertown, MD 21620
(Phone 301-778-3100)

Water Thermometers

Heathkit Company
Benton Harbor, MI 49022
(Phone 616-982-3200)

Other electric and mercury thermometers especially for measurement in water depths are available at sporting goods stores and through scientific supply houses.

Nets, Netting and Seines

Nichols Net and Twine Co.
Route 3, Bend Rd.
East St. Louis, IL 62201
(Phone 618-876-7700)

Nylon Net Co.
Box 592
Memphis, TN 38101
(Phone 901-525-8616)

Sterling Net & Twine Co.
18 Label St.
Montclair, NJ 07042
(Phone 201-783-9800)

Aerators and Air-Lift Pond Circulators

Aeration Industries
603 Lake St.
Excelsior, MN 55331

Eau Plaine Fisheries
Clarence Kalepp
Dorchester, WI 54425

KemBro, Inc.
Box 205
Mequon, WI 53092

Airo-Lator
8100 Passeo
Kansas City, MO 64131

Fresh-Flow Corp.
Rt. #1
Adell, WI 53001

Lake-Aid, Inc.
Rt. #2
Bismarck, ND 58501

Clean-Flo Labs
4342 Shady Oak Rd.
Hopkins, MN 55343

Hinde Engineering
Box 188
Island Park, IL 60035

Mineau Machine Co.
825 S. Baird St.
Green Bay, WI 54301

Liquid Rotenone:

“Chemfish”
Tifa (CI) Ltd.
Tifa Square
Millington, NJ 07946

“Noxfish”
Roussel Bio Corporation
P.O. Box 1077
400 Sylvan Ave.
Englewood Cliffs, NJ 07632

Cygnat Enterprises
Box 248, 1014 N. Bridge St.
Linden, MI 48451

“Prentox”
Prentiss Drug and Chemical Co.,
Inc.
21 Vernon St.
Floral Park, NY 11001

Algicides and Aquatic Herbicides

Most agricultural herbicide dealers

Dyes to Kill Aquatic Vegetation by Light Limitation

Aquashade, Inc.
Box 198
Eldred, NY 12732
(Phone 914-557-8077)



MSU is an affirmative-action, equal-opportunity institution. Cooperative Extension Service programs are open to all without regard to race, color, national origin, sex, or handicap.

Issued in furtherance of Cooperative Extension work in agriculture and home economics, acts of May 8, and June 30, 1914, in cooperation with the U.S. Department of Agriculture. I. Ray Gillespie, Interim Director, Cooperative Extension Service, Michigan State University, E. Lansing, MI 48824.

This information is for educational purposes only. Reference to commercial products or trade names does not imply endorsement by the Cooperative Extension Service or bias against those not mentioned. This bulletin becomes public property upon publication and may be reprinted verbatim with credit to MSU. Reprinting cannot be used to endorse or advertise a commercial product or company.

**Minor Revision-5M-5:89-TCM-HP-Price \$2.50, for sale only.
File 23.232 (Fish and Wildlife Habitat)**