

REPRINTED FROM
September
October
1977
THE MICHIGAN
NATURAL RESOURCES MAGAZINE
By Michigan State University
Cooperative Extension Service

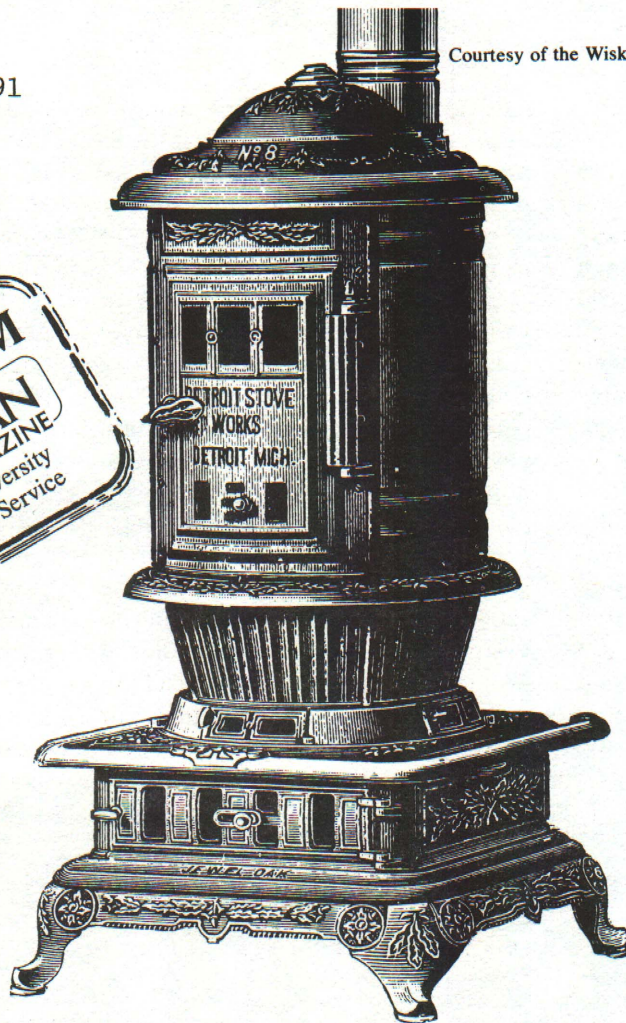

WOODSTOVES

Being A Compendium
Of Useful Information About Woodstoves
And Their Value
As Modern Home Heaters & Energy Conservers
****ALSO****
Wood As A Fuel,
Its Heating Qualities And Prices,
How To Buy, Stack & Store
This Most Useful & Excellent Natural Commodity
And Thereby
Reduce Our Need For Gas, Oil & Electricity

The Oldest Is New

Shortages and increased prices are predicted for oil, natural gas, and electricity in the near future. Many Michigan residents felt the crunch during last year's severe winter, and each year the demand for energy grows while our fuel supplies dwindle. People throughout the country are looking for other ways to heat their homes, and word has it that already more than half the homes in Vermont are heated in part or totally with wood. In this special MNR feature, we've asked an expert—and he's asked other experts—to give our readers sound advice on the selection, collection, storage, and burning of wood, the oldest new form of energy in America.

natural decomposition of wood—decay—which occurs naturally in the forest. Both burning and decay release carbon dioxide and heat, but of course in a fire the heat comes to us in concentrated form.

Unlike fossil fuels, our supply of wood is renewable—that is, we may cut and burn wood, but nature replaces what we burn in a rather short period of time. Coal, oil, and natural gas are, for all human purposes, nonrenewable—that is, nature replaces them over millions of years. For those who have a woodlot from which to cut and haul wood, buying such a stove can be an excellent investment. A 10 to 15 acre woodlot, if properly managed, can supply a family's firewood needs indefinitely. For most of us, of course, that's not pos-

course the wood of some "hardwoods" is as soft as the wood of some softwood trees, but dividing all trees into these two groups provides us with a handy generalization. Air-dried Michigan hardwoods will, on the average, supply about 20 to 25 percent more heat than wood left uncovered in the open to soak up moisture outdoors.

Dry 6-18 Months

For best drying, cut your wood to length, split what is too large for your stove, and stack it where air can move through the pile. Cover the top and upper sides of the pile under plastic or tarpaper, and boards. Keep piles off the ground by stacking them on pole-sized runners or old

HARDWOOD TREES	RATINGS FOR FIREWOOD		Does it have heavy smoke?	General rating and remarks
	Easy to burn	Easy to split		
Ash, red oak, white oak, beech, birch, hickory, hard maple, pecan, dogwood	Yes	Yes	No	Excellent.
Soft maple, cherry, walnut	Yes	Yes	No	Good.
Elm, sycamore, gum	Medium	No	Medium	Fair—contains too much water when green.
Aspen, basswood, cottonwood, yellow-poplar	Yes	Yes	Medium	Fair—but good for kindling.
SOFTWOOD TREES				
Southern yellow pine, Douglas-fir	Yes	Yes	Yes	Good but smoky.
Cypress, redwood	Medium	Yes	Medium	Fair.
White cedar, western red cedar, eastern red cedar	Yes	Yes	Medium	Good—excellent for kindling.
Eastern white pine, western white pine, sugar pine, ponderosa pine, true firs	Medium	Yes	Medium	Fair—good kindling.
Tamarack, larch	Yes	Yes	Medium	Fair.
Spruce	Yes	Yes	Medium	Poor—but good for kindling.

It's "Solar Energy"

Firewood is actually a form of solar energy. The process of leaf building in a tree changes energy of the sun and stores it in the tree in the form of wood. When we burn wood, we liberate this energy into our homes. Wood—when it burns completely—is a clean source of energy compared to other fuels. By burning wood, we only speed up the

sible, but there are other ways to get wood, discussed in this special feature, and they can be inexpensive and can produce sizable savings on your fuel bills.

Pound For Pound

No matter what the species, all wood can theoretically supply about the same amount of heat per pound. However, because of their high resin content, softwoods burn hotter and faster than hardwoods. Softwoods we group as needle-bearing trees; hardwoods as leaf-bearing trees. Of

boards. Unsplit wood dries from the ends to the middle; split wood dries evenly over its length. If there is room in your garage or basement, those drier conditions will decrease drying time. Another trick for drying wood faster is to cut the tree while the leaves are still on, then leave it until the leaves wilt. The attached leaves will draw out moisture rapidly. Dry all wood at least six months and preferably 18 months. Proper drying will not only provide more heat, but will reduce potential creosote problems within your chimney.

by Michael Zuidema

How Wood Burns

Energy efficiency, as it applies to wood burning stoves, is the percentage of total potential heat in the wood which is actually liberated into the area being heated. Some heat always escapes up the chimney, so no stove is 100 percent efficient. But some are much better than others. Wood combustion occurs in several stages. In stage one, the wood is heated internally and moisture is driven off as water vapor and steam. That's why green wood is not the best for burning. It consumes too much of its potential energy in removing the moisture, most of which escapes up the chimney as water vapor. During stage two, volatile gases, tars, and acids are burned or driven off, and as they leave, the wood breaks down into charcoal. Finally, the charcoal burns leaving only ash. All of these steps occur together in rapid sequence as a fire progresses through a log.

About 60 percent of the potential heat in wood is in the form of those volatile gases. In order to recover and release this energy, the fire must get hot enough to burn them. Included in the gases are tar droplets which form creosote. Thus, if these gases are left unburned, much of the potential heat is lost up the chimney and creosote buildup inside the flue itself could eventually cause a dangerous fire there. Farther on, we'll talk about the type of stoves that overcome these problems.

Helping The Forest

By harvesting wood for fuel, we can both heat our homes and also help productivity of the forest. People who own woodlots usually manage their trees in the same way—both to produce commercial forest products, and as a source of fuelwood. There are nearly 13 million acres of private woodlots in Michigan. Most of us, of course, do not own woodlots, but we can get free permits from either the DNR or the U.S. Forest Service to take any

“dead or downed” trees from public forest lands. There are 3.6 million acres of state forest lands in Michigan and 2.8 million acres of federal forest lands.

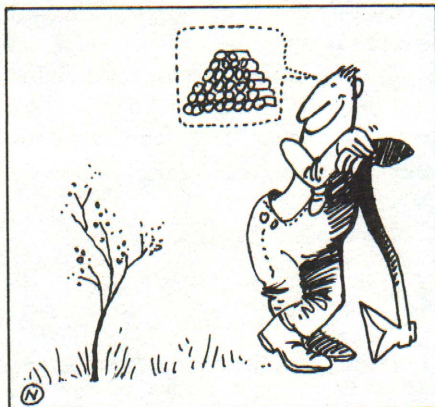

Getting Wood

Michigan presently has 13,000 acres of public state forest under “Timber Stand Improvement” plans. Those are areas where scruffy or mixed trees should be removed entirely so more even stands of trees can be developed. The U.S. Forest Service also has a large amount of acreage under such cuttings. You can get a free permit, either from the DNR or from the U.S. Forest Service, to take trees from such areas. That can be very tough work, however, and you may have to haul the stuff several hundred feet to your pickup or car trunk. So approach this method cautiously; it may be more expense and trouble than it's worth.

Another method is to get one or two neighbors and divide the cost of buying a whole truckload of eight-foot lengths from a jobber. They will probably deliver to your home or cabin or some suitable location where you can then cut the logs down to lengths desired. Savings over buying cords of cut wood can be sizable.

Or you might buy a stack from a jobber where it sits in the forest. That saves him loading and trucking his cut wood, so the price should be even more reasonable. It also keeps the confounded noise of the chain saw away from your neighbors, who like to sleep on Sunday morning.

Finding Foresters

Before making a trip afield for firewood, phone one of the state or federal forest offices listed below. If the forester himself is not available, his secretary or others in the office can probably lead you to: 1) timber stand improvement cuttings in that area; 2) loggers who might sell you a truckload or stack of logs; 3) firewood jobbers in the area. Also, if you plan to cut your own on a Timber Stand Improvement cutting, you will have to obtain a permit from the office in the area where you intend to cut.

State Area Foresters

Traverse City1-616-946-4920
Gaylord1-517-732-4154
Cadillac1-616-775-9727
Mio1-517-826-3211
Gladwin1-517-426-9205
Houghton Lake1-517-422-5522
Alpena1-517-354-2209
Baldwin1-616-745-4651
Baraga1-906-353-6654
Crystal Falls1-906-875-6622
Newberry1-906-293-5131
Sault Ste. Marie1-906-635-5281
Ishpeming1-906-485-4193
Escanaba1-906-786-2351
Manistique1-906-341-2518



U.S. District Rangers

Manistique1-906-341-5666
Munising1-906-387-2512
Rapid River1-906-474-6442
St. Ignace1-906-643-7900
Sault Ste. Marie1-906-635-5398
Baldwin1-616-745-4631
Cadillac1-616-775-8539
Manistee1-616-723-2211
Mio1-517-826-3717
Tawas1-517-362-4477
White Cloud1-616-689-3721
Bessemer1-906-667-9791
Iron River1-906-265-5139
Ontonagon1-906-884-2411
Watersmeet1-906-358-4649

Chain Saw Safety

The springy action of a small limb or sapling, caught suddenly by a moving chain saw blade, can bounce the entire saw back toward your arms or legs. To avoid such kickbacks, clear away all such small material before sawing. Also, wear heavy boots with built-in metal safety toes. The natural downward sawing motion of a chain saw carries it toward your legs and feet. And if

necessary tools for field repairs. And always carry a first aid kit.

Splitting Wood

Splitting wood before it is stacked reduces drying time, results in wood that burns more evenly, and helps eliminate water vapor that carries away your heat, and volatile distillates that form dangerous creosote in the chimney.

The most effective devices for

spots in the structure of the log. Strike your maul along these lines—not in the center of the log, but between the center and the edge of the log. If the log is short enough, and you are strong enough, and the day is cool enough, and the maul is heavy enough, you'll have fun, get good exercise, be impressed by how solid solar energy can be, and keep warm doing it. That way, you buy lots more than just a cord of fuel.

Other tips: A dull axe works well to split kindling and smaller pieces; it's also good for severing stubborn splinters that hold two halves of a split log together. Frozen wood splits easiest, followed by green wood, then dry wood. Mechanical splitters are becoming popular, but they're expensive, the gas fumes smell bad, and the noise can ruin an otherwise pleasant winter day.

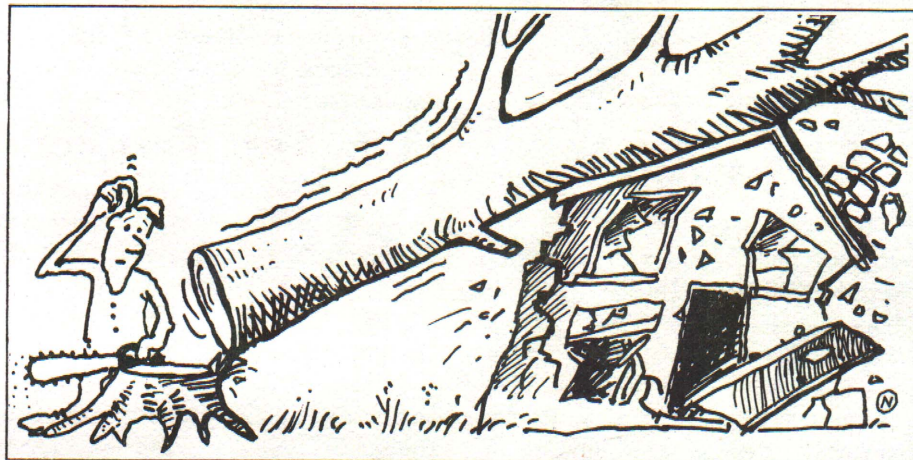

falling trees, wear a hard hat and safety glasses. Dead limbs supported above ground when the tree was upright may come crashing down as it falls. Chain saws are helpful, but dangerous, and accidents happen when people get tired, or become over-confident, or sloppy in handling.

Chain Saw Notes

You can sharpen the chain on your saw using a round file designed for that purpose, and available from any chain saw dealer. Anchor the saw by gripping the saw blade in a bench vise, or when afield by lodging it in a shallow saw cut where the sagging weight of a small tree "pinches" the blade and holds it steady. Your chain needs sharpening if it produces sawdust rather than small wood chips. Don't let the saw hit ground or stones—they are the quickest chain duller available. If going some distance from a dealer, or if working on a weekend when shops are closed, carry an extra spark plug, file, and

splitting wood are a splitting maul and a steel wedge. A splitting maul looks like a heavy, very dull axe, and the eight-pound variety, if you can swing it, is much more effective than the six-pounder. Wear safety glasses, as bits of steel sometimes fly off wedge or maul.

On partially dried wood, you'll notice small cracks that fan outward from the center toward the edge of a piece of unsplit wood. These are radial lines, and they indicate weak

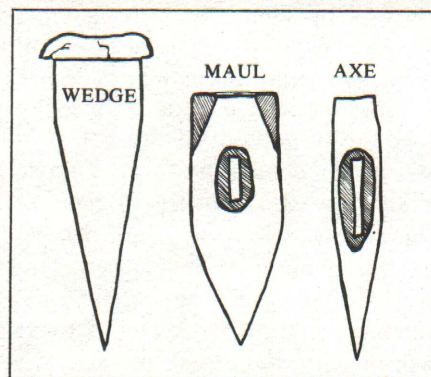

Split large or knotty logs with a wedge, smaller logs with a maul and use an axe to split kindling.

What's A Cord?

A cord of wood is defined in the dictionary as four-foot long logs piled parallel into a stack four feet high and eight feet long. But when you buy fuel wood, four-foot lengths won't fit in any stove this side of Gary, Indiana, so you are buying a "Michigan Cord," or a "Face Cord," or just a plain "cord of firewood." That means pieces of wood somewhere between 14 and 18 inches long in a stack four feet high and eight feet long.

Also, a cord of oak firewood will weigh far more than a cord of pine—and that translates into more

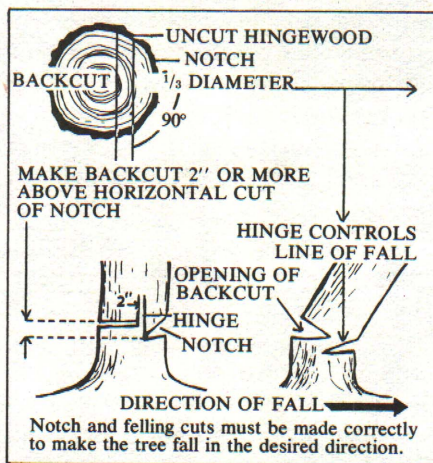

fuel and energy for you. Again, split wood will stack more densely in a pile than unsplit rounds. So when buying a cord of wood, you have a lot of questions to ask before agreeing to the price: How long are the pieces? (If 14 inches long, a cord is 37 cubic feet of wood; if 18 inches, it's 48 cubic feet—a big difference.) What kind of wood is it? Is it split? How long has it been drying? Does the price include delivery and stacking, or just delivery? (Usually the latter.) And if it's just dropped off in a heap beside your garage, how will you know that it measures out to a four by eight pile when you stack it? One way to answer this last question is to ask around for a reliable dealer,

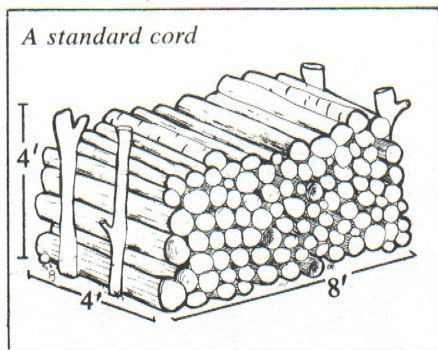

then tell him you're looking for a regular supplier and that you intend to measure each cord after it's stacked.

At this writing, a cord of wood in Michigan costs from \$20 to \$40, so there's lots of variety in quality and quantity. And Buyer Beware; there are many honest dealers around—but there are some of the other kind as well.

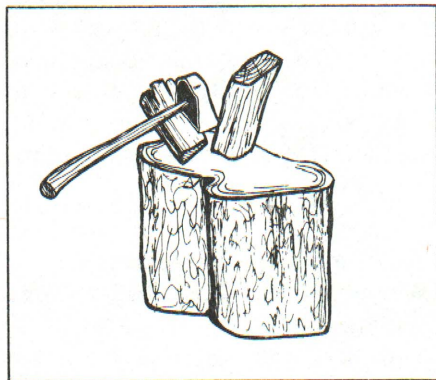

A splitting block, shown here, directs the impact of your swing into wood being split.

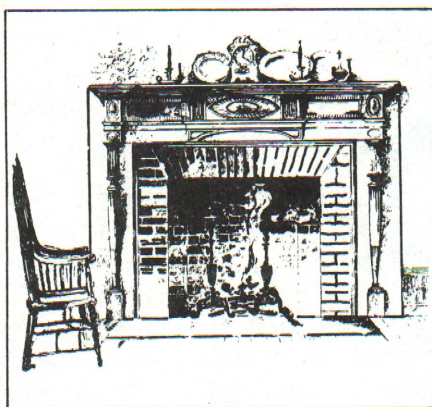

About Fireplaces

If you are trying to decide whether to build a fireplace into your home or install a wood-burning stove, consider the following: The net fuel efficiency of the average fireplace is zero! That is, fireplaces often drain as much heat out of a house through the chimney as they provide in the form of radiant heat to the building itself. The open front of a fireplace and the open or partially open draft, as long as a fire is burning at all, provides an excellent heat drain out of your house.

The efficiency of a fireplace can be raised to as high as 25 percent if a heat exchanger system is built into the unit and tight fitting glass doors are attached to the front. "Tube grates" also improve efficiency a bit, but tend to burn out in a short time. Still, no matter what you do to a fireplace, it will still burn up about four times more wood than an efficient and less expensive woodstove, and will deliver much less heat into the home. And a fireplace added to your home means higher taxes, while adding a woodstove usually doesn't change the property value.

About Woodstoves

Now this is important stuff: A good stove can provide, for use in your home, 50 to 75 percent of the heat energy contained in the wood you buy. The other 25 to 50 percent goes up the flue and is lost. So you want to push toward that 75 percent figure, and that's done by choosing the right stove to fit your conditions.

The Right Stove

There are two basic types of woodstoves—airtight and open. Open stoves look pretty, but they are generally less efficient, somewhat like fireplaces. See "About Fireplaces," above.

Airtight stoves have doors that close and small vents that open just a bit to allow enough air to enter so the wood burns. Some stoves have two vents, one at the bottom and another someplace else, this second designed to create "secondary combustion." What happens is this: As the wood burns, volatile gases are given off. These gases require four times as much air as it takes to burn your wood down to the charcoal stage. That means air entering at the bottom of a stove is used up before it can reach those upper gases—some of which you see burning as yellow flames. So the task is to get more air to those upper gases. And to do that, some stoves have direct air inlets in the upper part of the stove, while others have a "secondary combustion chamber" on top or at the back or side of a stove, and these may or may not help you.

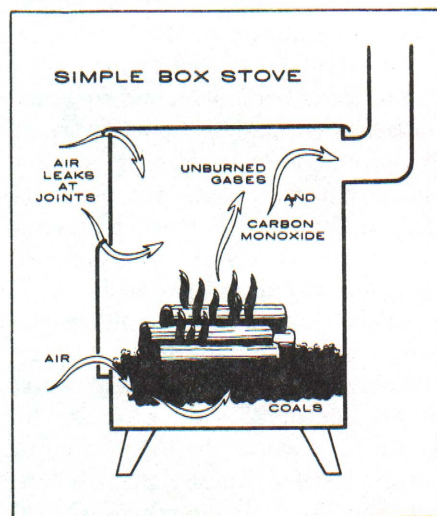

Open, box-type stoves such as the one above are about 30% efficient.

During 1966-1967 only 414 free wood permits were issued by the DNR. This year 15,000 will be issued.

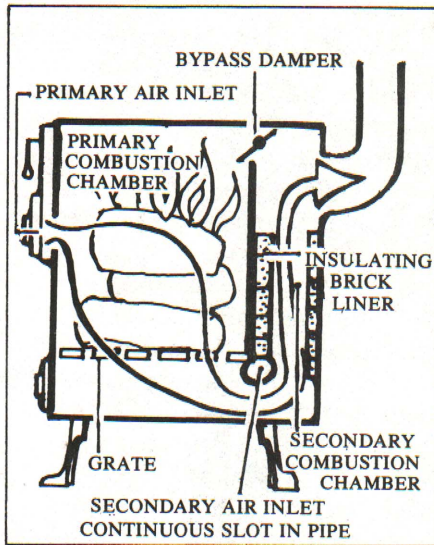

The stove has a secondary air inlet and a secondary combustion chamber.

The Slow Burn

If you want to fill your stove with big logs and have it burn long and slow, then you probably need a secondary combustion chamber, or some means of getting secondary air to the hot gases. But these gases may cool too much if the secondary chamber is too far away from the gaseous upper part of the fire. As a rough rule, secondary air is usually helpful only when introduced where flames already exist. If the stove is designed to carry long tongues of flame into a baffled secondary combustion area, and you plan to fire it hot enough to keep those flames entering that area, then that design is the one for you. If yours will run a bit cooler, and a bit longer, then the secondary air should probably be introduced closer to the top of the fire. This may mean no secondary chamber, just small adjustable vents, or an inlet pipe higher up in the stove, near where the top of the fire will be located. In any case, secondary combustion chambers should be baffled, or somehow designed to make the gases and flames swirl and mix, all of which improves combustion. If a secondary chamber works well, it can mean a difference of 10 percent greater efficiency over other closed stoves. Also, the longer flame path of such stoves means more heat

can be transferred to the larger surface of the stove, and then in turn be transferred to the room itself.

Heat Exchangers?

Another efficiency-gaining device is a heat exchanger, which is a sort of metal box, or bulb, connected to the stovepipe between the stove and the wall outlet. These add more baffling and metal surface area to capture more heat before the hot gases go out the chimney. But they aren't very attractive, they gum up with dangerous creosote quickly, and cleaning them is messy.

A Draft For Humans

Remember, too, that wood fires drain oxygen from the air inside a building, which can gradually make you drowsy. Open a basement window part way, or let in some fresh air occasionally to offset this loss.

Where To Put It?

If you lack space for a woodstove in your main living area, consider placing it in the basement, independent of your existing furnace. You will lose some heat to cold basement floors and walls, but much will also find its way upstairs. Some woodstoves are designed as fur-

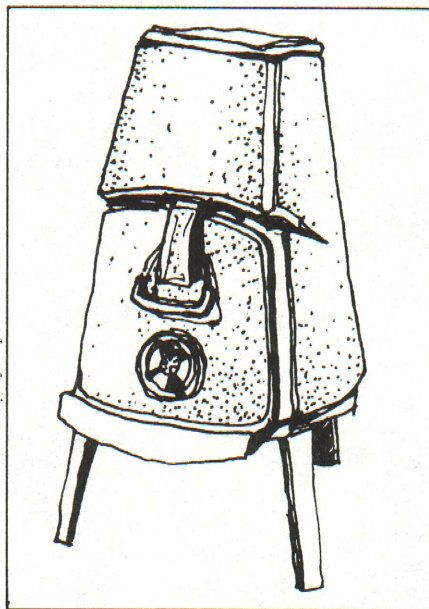

from The Woodburners Encyclopedia

naces, to operate with wood when you're awake and able to tend the fire; or with oil when you're not. We've heard, however, that oil jets in such furnaces tend to clog with ash, so move with caution on this one.

On the other hand, if you have an upstairs room available for stoving, with brick or stone wall as a backdrop, then you have the ideal conditions. The masonry will capture much of the heat when the fire is burning, then give it off to the room after the fire goes out. You can extend a chimney through two floors and out the roof if you want. Safe, approved, three-wall pipe is available, designed for a variety of such applications.

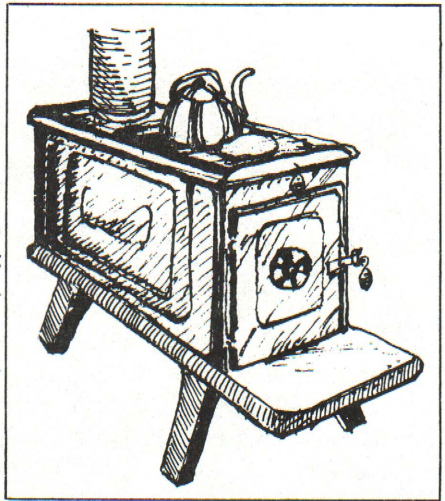

from The Woodburners Encyclopedia

Which Stove To Buy?

A large variety of wood-burning stoves are now on the market and as burning wood for heat becomes more popular, more stoves with more improvements are being manufactured. Basically, two classes of woodstoves are in use; those providing radiant heat and those providing circulating air heat.

A DNR or U.S. Forest Service free wood permit is valid for one calendar year, for a maximum 10' cords harvest (depending on the area). Most people only remove 1-2 cords of wood.

A Sun-like Heat

Radiant stoves transmit their heat outward from the stove through still air in the form of rays, like heat we receive from the sun. Objects are warmed by intercepting these infrared radiations, and then later the room air is heated by being in contact with the objects that have been heated by radiation. Compared to oil or gas forced air heat systems, radiant heat is usually more comfortable. It is the kind of heat you feel on a chill fall day when the sun's rays strike you.

Safer With Children

A circulating stove is a radiant stove wearing a metal jacket. The jacket has holes in it so air can get in and move around between the jacket and the stove itself. This air movement can either be created by an attached fan, or by the draft system that's created when the hot, lighter air inside the jacket begins to rise, pulling cold air in behind it at the bottom. This type of stove is safer if toddlers are nearby since the jacket doesn't get as hot as the inner stove. Another advantage is the reduced clearance space required between the stove and a wall, or other combustible material; the jacket is cooler, hence safer from a fire standpoint. From an aesthetic standpoint, however, circulators usually aren't so attractive as radiant heat stoves, most looking more like gas or oil space heaters rather than woodstoves. Circulating stoves radiate some heat, but most of their heat develops by heating and circulating hot air between the stove and the jacket.

One of the newest circulating stoves is the combination wood-oil furnace. These units are becoming popular in new home construction, and they are time efficient, at least. That is, most have rather large fireboxes and good damping systems, and will hold a fire up to 12 hours, so that the attached automatic oil furnace usually will not come out

during the night. However, as noted earlier, reports indicate that the bugs have not yet been worked out of these furnaces because oil spray nozzles tend to plug with wood ash.

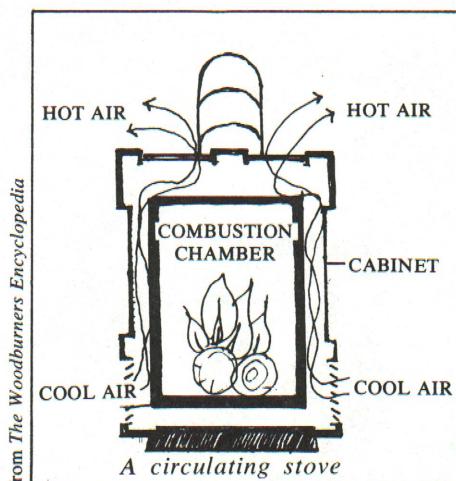

from The Woodburners Encyclopedia

Try Two Furnaces

Other circulating stoves which can be attached by ductwork to your existing furnace can be better. The efficiency of the woodstove is usually greater and the existing furnace can continue to be used without any basic changes. The woodstove simply fits into the ducting system and the problems of bark, chips, and wood ash are kept off that expensive living room floor. There are a number of such units on the market, ranging from good to quite poor. Some are simple non-airtight box furnaces which should be avoided because they simply aren't efficient burners. Other air-tight brands are designed with baffles or secondary combustion chambers which burn the volatile gases and have high efficiencies.

Hot Water Boilers

Wood burning boilers are available, but not common. The principle here is that the wood heats internal water-carrying coils, the water so heated is then moved into baseboard radiators and these in turn heat the building. Such boilers are becoming more available, and they have the advantage of all hot water furnaces in that they do not drain fresh air out

of a living space, but instead provide a pleasant radiant heat from, sure enough, radiators. If such a unit is attached to an existing hot water boiler, the heat from the wood burner will feed into the system and the gas or oil fired burner will then come on only when the temperature falls below the setting on the thermostat. Coils can also be installed in these boilers to heat water for domestic use.

Hot Water Heaters

Boilers are usually basement units, but there are also wood burning systems to provide hot water for household use. Some of these have small water reservoirs attached to the stoves themselves, others have coils or internal pipes that carry water through the stove and into an insulated tank located nearby.

More Notes on Stoves

Cast iron stoves are usually more expensive than sheet metal stoves, but are several times more durable. The quality of a cast iron stove can be determined by the thickness of the castings, and by the general weight and appearance of the casting itself. A good quality cast iron stove should last a lifetime, with one or two changes of grates over that long period of time. Grates, in fact, may not be needed, and there are arguments on both sides of this subject.



A Grate Discussion

Some voices hold that a stove without grates is like a tree without limbs. How does a person start a fire on a pile of old ashes? How does a person remove the ashes until all are dead out? Well, comes the reply, humans have been starting fires for a couple of hundred thousand years on nothing more than a flat surface, and if you can't, then you may not even be human. Furthermore, when it comes to hot ashes, you can't take them out of a stove *with* grates, either. But isn't it true that grates do promote more rapid fire development by lifting the fire out of the ashes so air can circulate underneath, isn't that true, isn't it, huh? Well, grumble grumble, maybe so. And isn't it true that early humans had to squat on their haunches and eat half-burned beaver steaks where we now sit in chairs and DINE? Well, grumble, grumble, I suppose so. And therefore doesn't it make sense to use GRATES, which are a magnificent invention after all, given to us by the hand of human creativity? Well, grumble, maybe so but I don't like 'em. New fangled. Gonna burn out and fall down and crack the stove bottom. . . .

Moving Right Along . . .

Some types of stoves are equipped with firebrick liners. Although these liners do keep the fire box hotter, and the combustion more complete, the brick insulates the stove walls so that heat transfer into the room is reduced. Other stoves provide a compromise by using brick only part way up the sides of the firebox.

An efficient stove need not be ugly. Many highly efficient stoves are also very attractive. Some, for example, have front doors that open so you can enjoy the sight of the fire at times, but also have an efficient stove when the doors are closed. The old Franklin stove is a prime example of this, but there are also some newer, more efficient, tighter

models now on the market. Some of these can operate on one loading for more than 12 hours.

Let's Have Coffee

Most stove tops are suitable for simple cooking chores such as soup heating, coffee making, and food



warming. Regular wood burning cooking ranges are also available, the ornate old types with ovens below and food warmers above and hot water reservoirs at the side, all designed to help you reduce your dependence on gas, oil, and electricity. However, the fireboxes of these stoves are usually somewhat smaller. Remember, too: A cooking range is designed primarily for cooking and produces room heat as a by-product. Woodstoves designed for room heating produce more heat, and can also be used for cooking. Your choice should depend on your primary need.

Pushing Hot Air

If you want to heat two or more rooms with a stove that can only be located in one, you have to provide some way for the hot air to circulate. Hot air rises, and if the upper third of the room with the stove is all closed in, like an upside down box, then most of the hot air will collect there and be of no use in the remainder of the house. To make use of such heat, you may have to knock some holes in those upper walls and install transom-like vents. Then, if you keep the doors opened slightly, the

cold air will move along the floor toward the stove, being drawn there by the natural draft system of the fire, and the hot air will move in behind it, through the upper wall vents, to heat the second room. If the door must be kept closed, either a small amount may be sawed off the bottom, or a grillwork can be installed in the lower panel of the door. Either way, you create an open pathway so cold air can flow out of the second room into the stove room.

Installing Your Stove

Most home fires caused by wood burning stoves occur because of poor or faulty installation. The most common causes of these fires are stoves placed too close to combustible walls and stove pipes installed through combustible materials without proper protection against ignition.

The National Fire Protection Association (NFPA) lists three approved ways to install a chimney connector through a wall:

- (1) Use of a ventilated type metal thimble. Such a thimble must be at least 12 inches larger in diameter than the chimney connector.
- (2) Use of a metal or burned fire-clay thimble, surrounded on all sides by at least eight inches of brickwork or equivalent fire proofing material.

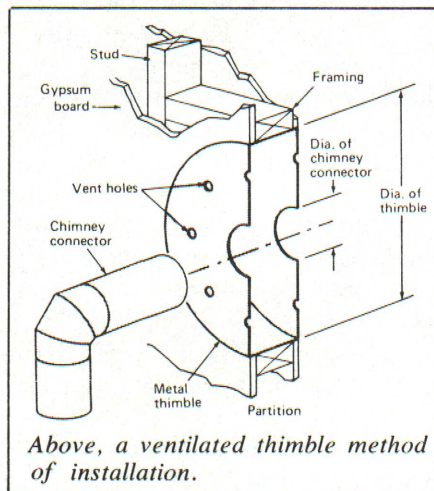

(3) Use of air space around the flue where all combustible material is cut out of the partition wall to provide not less than 18 inches clearance on all sides of the connector. Any material used to close this opening must be non-combustible insulating material.

The NFPA also accepts manufacturers' recommendations of insulated chimney pipe for use as a chimney connector, if they are tested and listed by a nationally recognized testing laboratory such as Underwriter's Laboratories, Inc. (UL). The necessary clearances from combustible materials are marked on each section of a UL approved chimney pipe.

Most of these insulated pipes require two inches of clearance from combustible materials. The common way to install a section of pipe through a wall is to use a metal ceiling support. This support will fit between 16-inch stud centers and still allow for the two inches of required clearance. Air holes drilled within this two-inch clearance area are an added precaution to keep the surrounding studs cool. If you want to go a step farther, sides of the studs facing the pipe can be covered with aluminum flashing to reflect heat away from the combustibles.

Using A Thimble

Use of insulated chimney pipe, and use of a chimney connector in a thimble surrounded on all sides by not less than eight inches of brickwork or concrete are the two most practical ways of installing a stovepipe through a wall and into a chimney. The ventilated thimble method is less attractive and takes a skillful carpenter to install properly. If you decide to use a ventilated thimble, you will probably need a sheet metal shop to make one to your specifications, as large units are not readily available at most stores. It also takes a skillful

carpenter to install a chimney connector through a wall where all combustible material is cut out of the wall to provide 18 inches of clearance on all sides.

Large steel flue pipe, often available cheap—or only—at junk yards, will serve as a durable thimble if the correct sized manufactured thimble cannot be purchased. And when installing the flue pipe itself, remember that the crimped ends should be turned toward the stove so any creosote will drip back into the stove rather than run down the outside of the pipe. Fasten the stovepipe together with three metal screws at each joint. On horizontal sections of pipe, turn the seam up to the high side and slant the pipe at least a quarter of an inch per lineal foot downward toward the stove so any creosote within the pipe can drip back into the stove. Use only 24 gauge or heavier stove pipe.

The table shown here, "NFPA Recommended Clearances," shows

closing the space between the top of the house foundation and the bottom of the floor with solid wood or several supports. If the brick wall is placed on an interior wall a carpenter should be consulted to determine the best way to support this weight for your individual situation.

Catching Heat

A brick wall behind your stove will serve as a heat catcher that will help even out temperatures in your home. The brick will heat up above room temperature and gradually release this warmth to the house long after the stove fire has resided.

The NFPA doesn't list clearances required for combustible walls covered by brick; however, 10 to 12 inches is generally a safe distance depending on the type of stove and the heat conductivity of the brick used. A larger space held between the brick and the wall for mortar spillage will also help protect the

Type of Protection	Distance From Stove type		Stovepipe diameter
	Radiant	Circulating	
Unprotected	36"	12"	18"
Quarter Inch Asbestos Millboard	36"	12"	18"
Quarter Inch Millboard out 1"	18"	6"	12"
28 ga. steel on Quarter Inch Board	18"	6"	12"
28 ga. steel out one inch	12"	4"	9"
28 ga. steel on 1/4" board, out one inch from wall or ceiling	12"	4"	9"

distances stoves should be located from combustible walls and ceilings. Of these methods, if space is limited and looks are important, spacing asbestos millboard out one inch with laths is the most practical way of protecting a combustible wall from overheating. The Masonite Company has recently marketed such a millboard with either a wood or brick design on the surface. The most efficient and perhaps the most attractive method of protecting a wall behind a stove is by building a complete brick covering over the wall. If the brick is placed next to an outside wall, the weight can be supported by en-

combustible wall behind.

If the stove has an optional heat shield and you want to be on the safe side, use it. Some manufacturers recommend their stove can be as close as 6 inches to a combustible wall when their heat shield is used.

If you plan to have a carpenter install your stove, don't assume he knows all the NFPA recommendations. Ask for a detailed explanation of what he would do. If it differs from what you have read, have him do it the right way. It is better to spend a little extra and do the job right than take the chance of burning down your house.

Hearth Ashes

The floor underneath a stove doesn't usually require as much protection from heat as the wall behind it because of the insulating properties of ashes in the bottom of the stove. But one reason to build a hearth or to protect the floor beneath a stove is to shield the floor from hot ashes and sparks that might fall on the floor and start a fire.

The NFPA advises that your stove legs provide at least four inches of clearance from the stove to the floor and that at least Number 24 gauge sheet metal should entirely cover the stove plus 18 inches in front, (or wherever the ashes are removed), and 10 inches on all other sides. Manufactured stove mats and stone work can also provide this protection.

We've said burning wood is clean—but a wood pile in the house can be mighty disturbing to a tidy housekeeper. If you live in the southern Lower Peninsula termites in the firewood could be a problem. Carpenter ants can come crawling out of softwoods and bark beetles may become apparent when warmer room temperatures drive them out of the wood. If you store wood outdoors and bring in small

loads as needed, expect dripping and puddles as wood thaws in the winter months.

Cleaning a stove is a messy chore too. Ashes often spill on the hearth and can smear decorative stone work with black streaks or smudges. A coat of masonry sealer on the hearth will give it a deep, wet look and make it easier to clean.

Don't throw out ashes—unless you throw them on your garden or



shrubs. Potash in ashes increases plant vigor and potassium helps produce those lush greens in plant leaves. Phosphorus stimulates growth and root formation. Wood ashes are twice as effective as lime for neutralizing acid soils so common in Michigan.

Chimneys

Unless you plan to use an existing chimney, building a new flue or outlet will be your biggest expenditure when installing a wood stove. A properly constructed chimney—either metal pipe or masonry—will increase total efficiency by insuring a good draft and fire safety, so the work should be done correctly, whichever flue system is used.

Be An Inspector

If using an existing brick or stone chimney, thoroughly inspect it for cracks or loose mortar where sparks and heat could lodge or seep through to woodwork nearby. That's how

houses burn down. The chimney may need to be rebuilt if in poor condition. One way to see such cracks or missing bricks is to tack a small mirror on a board, angled so you can see it from above, then lower it slowly into the chimney along with an extension electric cord and a light. During this same operation, take measurements of the flue opening; it should be at least 25 percent larger than the woodstove pipe connectors that you run into it.

Separate Flues

A separate chimney, or flue, should be used for your wood stove if possible, and in some cities and towns separate flues are required by building codes. Note that if a single flue is used for both a woodstove and a furnace or some other appliance, then the individual chimney connectors should be offset, one above or separated from the other. One should not go in one side of the chimney and the other into the same chimney at the same location on the opposite side. Such an arrangement would cause one to smoke while the other was being operated. Even side by side but separate chimneys can cause smoke back drafts; smoke may go up one chimney, cross to the other, and go back down and into the house. Any stove with an open face, such as the Franklin type, should definitely have its own chimney flue, as smoke-backing is a definite problem with such stoves.

Interior Is Best

When building a chimney from scratch, an interior masonry chimney is probably your best bet. Such a structure is not affected by outside temperature changes, so inside condensation would be lessened. That means less cracking, less creosote, and therefore less chance of a chimney fire. Because the draft is greater, the potential for complete combustion, and consequent heat release into the house is greater. For these reasons, an interior masonry chimney is often 15 percent more efficient



than an exterior masonry chimney.

If on the other hand, your situation calls for an exterior masonry chimney, then remember Ben Franklin's advice: Build on the south side of the house where the chimney can be warmed by the sun and shielded from chill northern winds. That advice is still sound today.

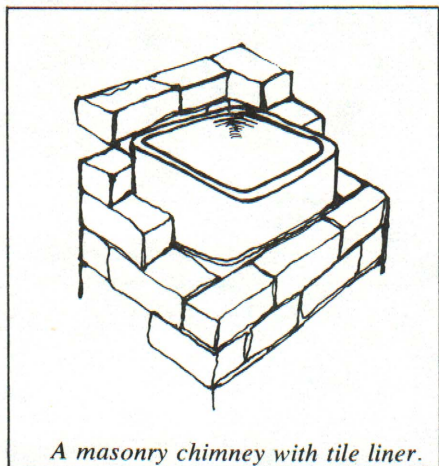

A masonry chimney with tile liner.

Clearances

Building codes differ from town to town, but they generally require masonry chimneys to be separated from combustibles by at least two inches of dead air space. An exterior chimney usually must have either a one-inch clearance or be separated from combustibles by a half-inch plaster board. Flue liners—those heavy masonry tubes that are built inside brick or stone chimneys, should be mortared together as the chimney is built around them, and a chimney cap should be added on the top. The cap keeps rain out, holds heat in, and guards against drafts going back down the chimney. Generally, the top of the flue should be a minimum of two feet above any roof peak that runs within ten feet of it. After the chimney is built, if the draft produced is inadequate, you may have to build it a bit higher.

Metal Pipes

Insulated metal chimneys, which look like stovepipes, are safe and easy to install. Because they warm up rapidly, there is usually a minimum of creosote build-up. However, if green wood or soft-

woods are used frequently and creosote does become a problem, chimney fires could result and damage such metal chimneys, reducing their life expectancy. Also, burning trash in a woodstove may cause chemical fumes that could corrode the metal pipe. But reports disclose that insulated chimneys, some now 20 years

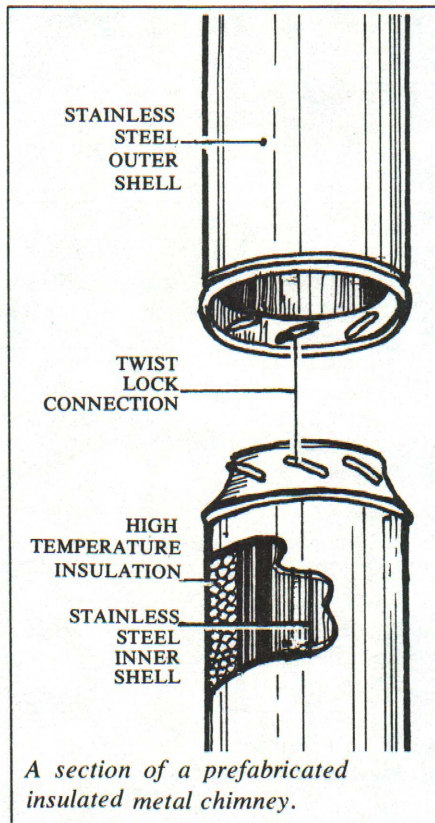

A section of a prefabricated insulated metal chimney.

old, are still in good condition, indicating that proper use has had its effects.

FIRE! FIRE! FIRE!

Most dangerous creosote buildup occurs in the fall and spring when fires are damped down to "smolder levels" because less heat is needed. To offset the effects of this smoldering, build occasional short, hot fires. These will produce enough heat to burn off or melt the tarry substance back into the stove where it can be burned. And if you burn softwoods regularly, open the draft periodically to insure a rapid, hot fire that will consume these resins.

If a chimney fire ever does occur, of course call the fire department immediately, but realize that the

water poured on the hot chimney will probably crack it. Before the firemen arrive, if possible, dump a large quantity of coarse salt into the firebox of the stove and then shut it up as tightly as possible, closing off all vents. Salt from a water softener, or supplies kept to melt driveway ice could be used for this. This should

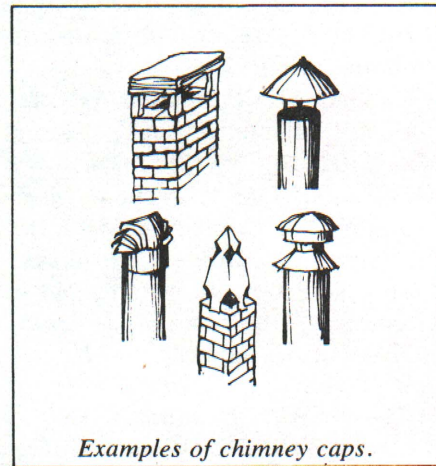

Examples of chimney caps.

kill both the fire in the stove, and the fire in the chimney, as escaping chlorine gas goes up the flue system and replaces the oxygen which allows the fire to burn in the chimney. Of course if two or more appliances—such as furnace and woodstove—are using the same chimney, you'll have to cut off the air supply from both to damp the fire down. And don't whiff that chlorine gas; it was used to poison soldiers in World War II. Most, of course, will go up the chimney, where it's supposed to go, so it shouldn't be a problem.

At the very least, make a careful chimney inspection at least once a year. If you can't find a chimney sweep (a few people have already returned to this once thriving occupation) then you can clean it yourself. One way is to lower a set of tire chains on a rope through the length of the chimney, banging it back and forth all the way down. Then clean out the tumbled residue at the bottom. Another way is to lower a rope down the chimney, then tie a brushy tree limb, or small evergreen on the rope and pull it up through the chimney. This should scratch and scrape the material away. □

Further Reading

Cooperative Extension Service, Cornell University, *Making and Using Wood Fuel*, Ithaca, N.Y.

Gay, Larry, *The Complete Book of Heating with Wood*, Garden Way Publication, 1974, Charlotte, Vermont.

Havens, David, *Woodburner's Handbook*, Media Publications, Portland, ME, 1973.

National Fire Protection Association, 470 Atlantic Avenue, Boston, Mass. 02210, *NFPA Inspection Manual and Fire Protection Handbook*, NFPA Number 89M—*Heat Producing Appliance Clearances*, 1976—NFPA Number 211—*Chimneys, Fireplaces and Vents*, 1972—NFPA Number 224—*Homes and Camps in Forest Areas*, 1974—NFPA Number HS-8—*Using Coal and Wood Stoves Safely*—1974.

Ross, Bob & Carol, *Modern & Classic Woodburning Stoves*, \$10.00, The Overlook Press, Woodstock, N.Y. 12498.

Shelton, Jay & Shapiro, Andrew, *The Woodburner's Encyclopedia*, 1977, \$6.95 (add 75¢ postage), Vermont Cross Roads Press, Box 333, Waitsfield, Vermont 05673.

U.S. Department of Agriculture—Forest Service—*Firewood for Your Fireplace*, Leaflet number 559, Superintendent of Documents, U.S. Government Printing Office, Washington, D.C. 20402, 25¢.

U.S. Department of Agriculture—Forest Service—*Northeast Areas—State and Private Forestry*, Upper Darby, Pa. 19082, *Improve Your Woodlot by Cutting Firewood*, by Lancaster & Hunt.

Vivian, John, *Wood Heat*, \$8.95, Rodale Press.

Wood Burning Quarterly & Home Energy Digest, 8009 34th Avenue South, Minneapolis, Minnesota 55420. \$5.00 per year

Special thanks for technical assistance to: Harold Kollmeyer, DNR Forestry Division Geneva and George Wiskemann, Lansing Henry Huber, MSU Forestry Department National Fire Protection Association Larry Hemsall, Chimney Sweep Guild Tim Widener, Lansing Community College



WOODSTOVE SOURCES

Below is a list of stove manufacturers, importers and retailers that was compiled to give our readers an assortment of places to write for information on a variety of stoves.

In addition, hot off the press in September, is a directory of manufacturers, dealers and accessory outlets of wood stove and fireplace equipment. For your copy send \$2.00 (+50¢ postage and handling) to the "Woodstove, Fireplace and Equipment Directory," Box 4474, Manchester, N.H. 03108 or check with your local bookseller.

Airtight Stoves

Ashley, Martin Industries
Box 730
Sheffield, AL 35660

Atlanta Stove Works
Box 5254
Atlanta, GA 30307

Auto-crat
Illinois and Benton Sts.
New Athens, IL 66264

Brown Stove Works
Box 490
Cleveland, TN 37311

Locke Stove Co.
114 W. 11th St.
Kansas City, MO 64105

U.S. Stove Co.
S. Pittsburgh, TN 37380

Base-burning airtight stoves

Riteway Mfg. Co.
Box 6
Harrisonburg, VA 22801

Box Stoves

Martin Industries
1604 17th Ave., S.W.
Sheffield, AL 35660

Portland Stove Foundry
Portland, ME 04104

Washington Stove Works
Box 687
Everett, VA 98206

Downdraft Stoves

Vermont Woodstove Co.
Bennington, VT 05201

Scandinavian Stoves

Jotul, Kristia Associates
Box 1118
Portland, ME 04104

HDI Importers
Schoolhouse Farm
Etna, NH 03750

Tekton Design Corp.
Conway, MA 03141

Southport Stoves
Division of Howell Corp.
248 Tolland St.
E. Hartford, CT 06108

Miscellaneous Stoves

The Fireplace
101 Elmwood St.
State College, PA 16801

Fisher Stoves, Inc.
River Road Bow, NH 03301

Warm Energy Ctr.
Junction Routes 16 & 302
N. Conway, NH 03818

Old Country Appliances
Box 330
Vacaville, CA 95688

Vermont Castings, Inc.
Box 126 Prince St.
Bennington, VT 05201

Mohawk Industries, Inc.
173 Howland Ave.
Adams, MA 01220

Good Time Stove Co.
Rte. 112
Goshen, MA 01032



Cooperative Extension Service Programs are open to all without regard to race, color, or national origin. Issued in furtherance of cooperative extension work in agriculture and home economics, acts of May 8, and June 30, 1914, in cooperation with the U.S. Department of Agriculture. Gordon E. Guyer, Director, Cooperative Extension Service, Michigan State University, East Lansing, MI 48824. Price 35 cents.