

75¢

Extension Bulletin E-1025, Sept. 1976
COOPERATIVE EXTENSION SERVICE
MICHIGAN STATE UNIVERSITY

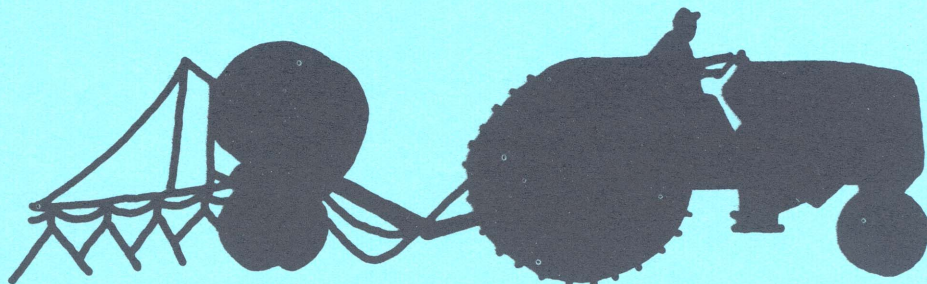

SAFE, EFFECTIVE USE OF PESTICIDES

A MANUAL FOR PRIVATE APPLICATORS

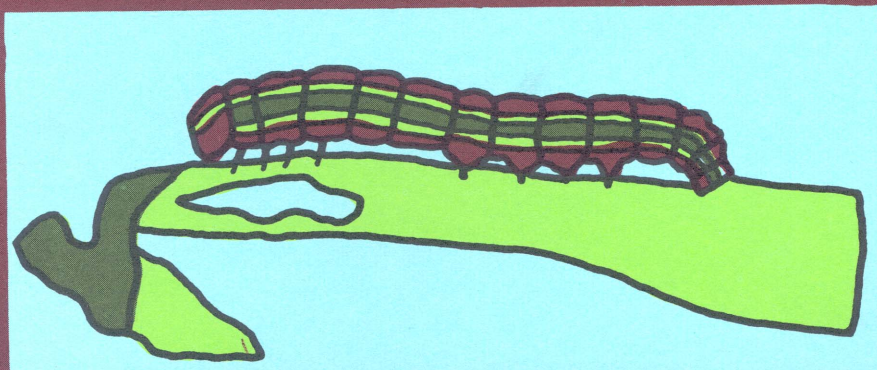
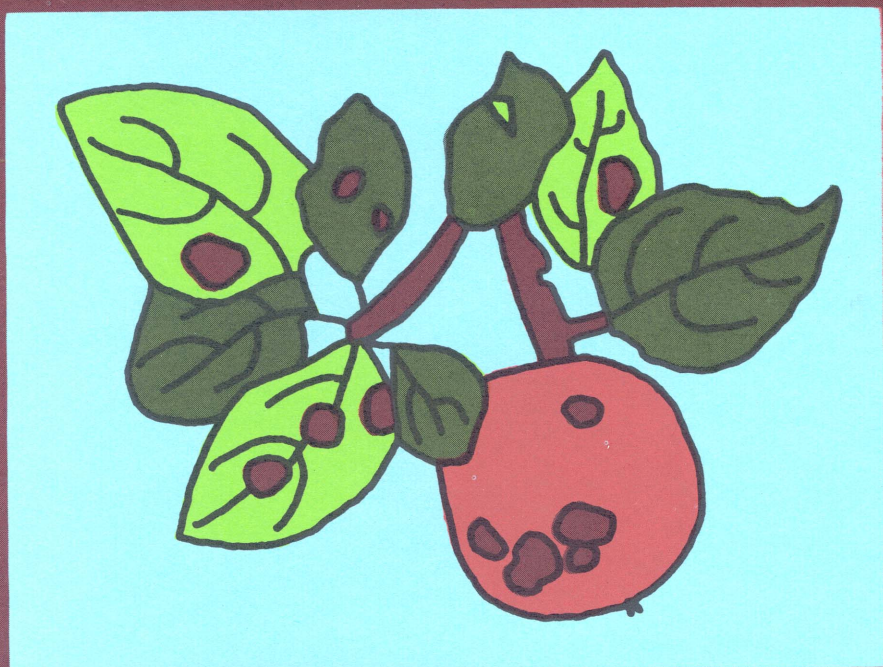

TELEPHONE NUMBERS FOR PESTICIDE EMERGENCIES

In Case of Poisoning

Phone Number

Your family physician _____

Your nearest poison treatment center _____

(see page 35)

In Case of Fire or Major Spills

Your local police or sheriff _____

Your local fire department _____

Department of Natural Resources _____ (517) 373-7660

Detach and affix near your phone.

THIS SIDE TO BE COMPLETED BY MDA

THIS CARD IS YOUR FEE RECEIPT AND APPROVAL TO TAKE THE PESTICIDE APPLICATOR'S CERTIFICATION EXAMINATION. YOU MUST BRING THIS CARD AND SOME FORM OF IDENTIFICATION WITH YOU TO BE ADMITTED.

EXAM WILL BE GIVEN AT THE FOLLOWING TIME AND PLACE:

COUNTY _____

CITY _____

LOCATION _____

DATE & TIME _____

(Return this half only.)

MICHIGAN DEPARTMENT OF AGRICULTURE
5TH FLOOR, LEWIS CASS BUILDING
P.O. BOX 30017
LANSING, MI 48909

SELF ADDRESS

ATTACH
STAMP
HERE

Name

Address

City

State

Zip Code

Applicant's Signature

Complete address side of Fee Receipt Card (on cover flap) and Application Form (first page) and return to Michigan Department of Agriculture in attached envelope. (READ INSTRUCTIONS BELOW.)

PROCEDURES FOR CERTIFICATION AS A PRIVATE APPLICATOR OF RESTRICTED USE PESTICIDES

The Michigan Pesticide Control Act of 1976 requires that private applicators become certified to purchase, use or supervise the use of pesticides classified for restricted use. A *private applicator* is defined in the law as a person who applies or supervises the application of a pesticide for purposes of producing an agricultural commodity on property owned or rented by that person or his employer or, if applied without compensation other than trading of personal services between producers of agricultural commodities, on the property of another person. *Agricultural commodity* means a plant or part thereof, or an animal or animal product produced primarily for sale, consumption, propagation, or other use by man or animals.

Only one person per farm needs to be certified provided that the certified applicator supervises the application of the pesticide. The certified applicator does not have to be physically present unless the labeled instructions on the pesticide require the physical presence of a certified applicator. The certified applicator is responsible for the actions of a noncertified applicator under his control and must provide instructions for using the restricted pesticide and for contacting the certified applicator in the event he is needed.

Certification as a private applicator requires passing of an examination to demonstrate the applicant's knowledge of the safe, effective

use of restricted pesticides. This manual is prepared as an aid in meeting this requirement. A person who is unable to read or is unable to pass a written examination may request an oral interview to demonstrate competency.

The application form (next page) and fee receipt card (cover flap) are included in this manual for your convenience. The list of examination locations and dates is available from the Cooperative Extension Service or the Michigan Department of Agriculture.

In order to avoid unnecessary delays in processing the application, complete all blanks or questions on the application form except those marked "Department Use Only." Be sure to indicate which examination site and date you prefer. Self-address, stamp and sign the fee receipt card.

Send the application and fee to the Michigan Department of Agriculture at the above address. Fees should be remitted by check or money order payable to the *State of Michigan*. PLEASE DO NOT MAIL CASH.

Upon receipt of the completed application, fee receipt card and application fee, the department will process the application and return the fee receipt card. The returned receipt card will bear a file number. Retain the fee receipt card and present it to the examination monitor at the designated examination site.

APPLICATION FEE:
\$10.00

MICHIGAN DEPARTMENT OF AGRICULTURE
PLANT INDUSTRY DIVISION
LANSING, MICHIGAN 48909

DEPT. USE ONLY	
FILE NUMBER	CO. CODE

PRIVATE
PESTICIDE APPLICATOR'S CERTIFICATION APPLICATION

SEND APPLICATION IN AT LEAST 3 WEEKS PRIOR TO THE DATE YOU WISH TO TAKE THE EXAMINATION.

PLEASE PRINT OR TYPE

NAME OF PERSON APPLYING			TELEPHONE NUMBER
LAST	FIRST	MI	AREA CODE ()

ADDRESS (NO. & STREET OR RFD)

CITY	COUNTY	STATE	ZIP CODE	BIRTH DATE
				MO. DAY YEAR

ARE YOU CERTIFIED BY ANOTHER STATE? <input type="checkbox"/> YES IF YES COMPLETE <input type="checkbox"/> NO NEXT TWO ITEMS →	STATE ISSUING CERTIFICATE	EXPIRATION DATE
---	---------------------------	-----------------

HAVE YOU EVER BEEN FOUND GUILTY IN A COURT OF LAW OF MISUSE OF PESTICIDES?
 YES NO IF YES, GIVE PARTICULARS. USE ANOTHER SHEET OF PAPER.

DO YOU PERSONALLY OPERATE AIRCRAFT TO APPLY A PESTICIDE? <input type="checkbox"/> YES <input type="checkbox"/> NO	DO YOU PERSONALLY OPERATE SPACE FUMIGATION EQUIPMENT? <input type="checkbox"/> YES <input type="checkbox"/> NO
---	--

ENTER THE EXAM NUMBER AND THE COUNTY YOU PREFER FOR YOUR EXAMINATION. SEE THE LIST OF EXAM LOCATIONS & DATES AVAILABLE FROM THE COOPERATIVE EXTENSION SERVICE OR THE MICHIGAN DEPARTMENT OF AGRICULTURE.	EXAM NUMBER	COUNTY
--	-------------	--------

THIS IS TO CERTIFY THAT THE FOREGOING IS TRUE AND ACCURATE TO THE BEST OF MY KNOWLEDGE AND BELIEF AND THAT I WILL COMPLY WITH THE PROVISIONS OF ACT 171, PUBLIC ACTS OF 1976 AND ALL REGULATIONS PROMULGATED THEREUNDER. I UNDERSTAND THAT FALSIFYING INFORMATION ON THIS APPLICATION IS GROUNDS FOR DENYING OR REVOKING CERTIFICATION.

DATE	APPLICANT (SIGNATURE)
------	-----------------------

MAKE REMITTANCE, BY CHECK OR MONEY ORDER, PAYABLE TO STATE OF MICHIGAN.
MAIL TO MICHIGAN DEPARTMENT OF AGRICULTURE, 5TH FLOOR, LEWIS CASS BUILDING
P.O. BOX 30017, LANSING, MI 48909
MAIL AT LEAST 3 WEEKS BEFORE YOUR PREFERRED EXAMINATION DATE.
APPLICATION FEE CANNOT BE RETURNED IN CASE CERTIFICATION IS NOT GRANTED.

PLEASE COMPLETE STUB

BE SURE TO ENCLOSE YOUR COMPLETED FEE RECEIPT CARD

NAME

NO. & STREET OR RFD

CITY, STATE & ZIP CODE

PRIVATE
PESTICIDE APPLICATOR'S
CERTIFICATION APPLICATION

THIS STUB IS PART OF THIS DOCUMENT. DO NOT SEPARATE FROM APPLICATION.
MAKE REMITTANCE, BY CHECK OR MONEY ORDER, PAYABLE TO STATE OF MICHIGAN.
MAIL TO MICHIGAN DEPARTMENT OF AGRICULTURE, 5TH FLOOR, LEWIS CASS BUILDING
P.O. BOX 30017, LANSING, MI 48909

Preface

This guide has been modified by the Cooperative Extension Service of Michigan State University from material prepared by the Pesticide Operations Division, U.S. Environmental Protection Agency (EPA), and the Extension Service, U.S. Department of Agriculture (USDA).

The contributors are from state land grant universities, USDA, EPA, and the pesticide industry. They include:

J. Blair Bailey, *University of California*
Emerson Baker, *Environmental Protection Agency*
John Boehle, Jr., *Ciba-Geigy Corporation*
James J. Bonin, *Consultant*
B. Jack Butler, *University of Illinois*
James E. Dewey, *Cornell University*
Burton R. Evans, *Environmental Protection Agency*
William D. Fitzwater, *Environmental Protection Agency*
L. C. Gibbs, *U.S. Department of Agriculture*
Edward H. Glass, *New York Agricultural Experiment Station*
Wayland J. Hayes, Jr., *Vanderbilt University*
Fred W. Knapp, *University of Kentucky*
John A. Lofgren, *University of Minnesota*
Otis C. Maloy, *Washington State University*
James F. Miller, *University of Georgia*
Frank Murphey, *University of Delaware*
Edward L. Nigh, Jr., *University of Arizona*
Arthur Retan, *Washington State University*
Harry K. Tayama, *Ohio State University*

Gerald T. Weekman, *North Carolina State University*, joint consultant for EPA and USDA, organized the project and served as editor. He was assisted by Mary Ann Wamsley, USDA.

Many other people contributed greatly to the book by reviewing it at various stages. They represent EPA, USDA, state regulatory agencies, the pesticide industry, environmental groups, and applicator associations.

Contributors to this Michigan manual included:
Donald Cress, *Michigan State University*
Robert Kirkpatrick, *Michigan Department of Agriculture*
George Bird, *Michigan State University*
Richard Sauer, *Michigan State University*
Robert Ruppel, *Michigan State University*
Thomas Dudek, *Michigan State University*

CONTENTS

Laws and Regulations	1
Pests	5
Pest Control	16
Pesticides	20
Labels and Labeling	29
Protecting Man — Using Pesticides Safely ..	33
Protecting the Environment	40
Safe Use Precautions	43
Application Equipment	48

WEIGHTS AND MEASURES

Weights

16 ounces = 1 pound
1 gallon water = 8.34 pounds

Liquid Measure

1 fluid ounce = 2 tablespoons
16 fluid ounces = 1 pint
2 pints = 1 quart
8 pints = 4 quarts = 1 gallon

Length

3 feet = 1 yard
16½ feet = 1 rod
5,280 feet = 320 rods = 1 mile

Area

9 square feet = 1 square yard
43,560 square feet = 160 square rods = 1 acre

Speed

1.466 feet per second = 88 feet per minute = 1 mph

Volume

27 cubic feet = 1 cubic yard

SOME SUGGESTIONS ON STUDYING THIS MANUAL

The information presented in this manual is designed to assist prospective private applicators to meet the certification requirements under the federal guidelines. Some of it you may already know from your experience with using pesticides. The manual contains nine sections. A list of self-help questions and instructions for completing the questions are at the end of each section. If you encounter difficulties in using the manual, please consult your county agricultural extension agent or representative of the Michigan Department of Agriculture for assistance.

Some suggestions on studying the manual are:

1. Find a place and time for study where you will not be disturbed.
2. Read the entire manual through once to understand the scope and form of presentation of the material.

3. Then study one section of the manual at a time. You may want to underline important points in the manual or take written notes as you study the section.
4. Answer, in writing, the self-help questions at the end of each section. Instructions on how to use the self-help questions in your study are included with the questions. These questions are intended to aid you in your study and to help you evaluate your knowledge of the subject. As such, they are an important part of your study.
5. Reread the entire manual once again when you have finished studying all of its nine sections. Review with care any sections that you feel you do not fully understand.

This manual is intended to help you use pesticides effectively and safely when they are needed. We hope that you will review it occasionally to keep the material fresh in your mind.

USE PESTICIDES SAFELY AND EFFECTIVELY

SECTION 1: Laws and Regulations

Without pesticides, we would not have the food, fiber, and landscape plants we need. But because pesticides can be dangerous, Congress has passed laws affecting pesticide use. These laws try to balance the need for pesticides with the need to protect people and the environment from their misuse.

FEDERAL INSECTICIDE, FUNGICIDE, AND RODENTICIDE ACT (FIFRA), AS AMENDED

You are taking this training because of a law passed by Congress in 1972. It is often called by its initials — FIFRA. It requires you to show that you know the correct way to use and handle pesticides.

Here are the parts of the law that concern you the most:

- It says that all pesticide uses must be *classified* as either general or restricted.
- It requires you to be *certified* as competent to use any of the pesticides classified for restricted use, and
- It provides *penalties* (fines and jail terms) for people who do not obey the law.

Congress chose October 21, 1977, as the date for certification to go into effect. The Environmental Protection Agency (EPA), acting under federal law, has by regulation set minimum standards of competency for all commercial applicators. Michigan has developed a plan for certification of competency that meets minimum national standards. The certification plan in Michigan is administered by the Michigan Department of Agriculture.

Classification of Pesticides

Manufacturers must register every pesticide with EPA. By regulation, when each pesticide is registered, all its uses must be classified. EPA must decide whether each use is a general or a restricted one.

Under the law, pesticide uses that will damage the environment very little or not at all when used as the label directs can be classified as *general uses*. Uses that could cause damage even when used as directed on the label must be classified as *restricted uses*. They may be carried out only: (a) by someone who is certified, or (b) under a certified person's supervision.

Some pesticides may be classed as general use under some conditions and restricted use under others.

Certification of Applicators

What is certification? It is proof that you know the safe and correct way to carry out restricted uses.

Prohibited Actions

The new law names many things you cannot do. These two concern you most:

1. You may not use a pesticide other than as the label or labeling directs, except when special regulations allow you to use it at a lower rate than the label recommends.
2. You may not dispose of any pesticide or its container except as the label or labeling directs.

The applicator is responsible for proper pesticide use.



Penalties

If you violate the FIFRA, you are subject to civil penalties. They can be as much as \$1,000 for each offense. Before EPA can fine you, you have the right to ask for a hearing in your own city or county. Violations of the law may also subject you to criminal penalties. They can be as much as \$1,000 or 30 days in prison, or both.

OTHER REGULATIONS

Transportation

Shipment of pesticides and other dangerous substances across state lines is regulated by the Federal Department of Transportation (DOT). DOT issues the rules for hauling these materials.

DOT standards tell you which pesticides are dangerous to man, and create a health hazard during transportation.

If you ever haul pesticides between states, you should know that:

1. They must be in their original packages. Each package must meet DOT standards.
2. The vehicle must have a correct sign. Manufacturers must put the correct warning signs on each package.
3. The pesticides may not be hauled in the same vehicle with food products.
4. You must contact DOT right away after each accident:
 - a. when someone is killed,
 - b. when someone is injured badly enough to go to a hospital, or
 - c. when damage is more than \$50,000.
5. You must tell DOT about all spills during shipment.

Local laws may require you to take additional precautions.

Aerial Application

Application of pesticides from airplanes also is regulated by the Federal Aviation Administration (FAA) and by Michigan Aeronautics Commission. FAA judges:

- the flying abilities of pilots, and
- the safety of their aircraft.

FAA rules, too, say that an aerial applicator may not apply any pesticide except as the label directs.

Worker Safety

The Occupational Safety and Health Act of 1970 is administered by The Occupational Safety and Health Administration (OSHA) in the Department of Labor (DOL). It requires anyone with 11 or more workers to keep records and make reports. The records must include all *work-related* deaths, injuries, and illnesses. Minor injuries needing only first aid treatment need not be recorded. But a record must be made if the injury involves:

- medical treatment,
- loss of consciousness,
- restriction of work or motion, or
- transfer to another job.

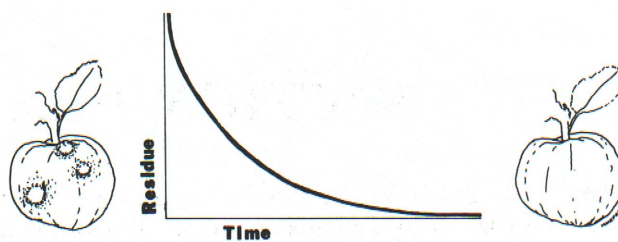

Residues

The pesticide that stays in or on raw farm products or processed foods is called a *residue*. EPA sets residue *tolerances* under regulations authorized by the Federal Food, Drug, and Cosmetic Act. A tolerance is the concentration of a pesticide that is judged safe for human use. Residues in processed foods are considered to be food additives and are regulated as such.

Tolerances are expressed in parts per million (ppm). One ppm equals one part (by weight) of pesticide for each million parts of farm or food product. Using pounds as a measure, 50 ppm would be 50 pounds of pesticide in a million pounds of the product. The same pesticide may have a different tolerance on different products. It might be 50 ppm on grapes and 25 ppm on apples.

If too much residue is found on a farm or food product, the product may be seized or condemned.

The label will tell you how many days before harvest the pesticide may be applied. Follow the label exactly. Then you can be sure you are not breaking the law.

MICHIGAN PESTICIDE CONTROL ACT

In order to assure that farmers of this state will continue to have access to essential and commonly used pesticides, the Michigan Legislature passed the Pesticide Control Act of 1976. This legislation gives the director of agriculture authority to certify private applicators (farmers) as required by the federal law and to prescribe standards for certification by regulation. Some important provisions of the act that you should be familiar with are listed below:

1. Any person using or supervising the use of a "restricted use" pesticide must be certified by the director of agriculture.
2. Commercial applicators for hire must be certified to use or supervise the use of both "general use" and "restricted use" pesticides.

3. Commercial applicators for hire must obtain an annual license and provide proof of financial responsibility.
4. Noncertified applicators applying restricted use pesticides must be under the control and supervision of a certified applicator.
5. Dealers who sell restricted use pesticides must obtain an annual license and submit a record of sales to the director.
6. Restricted use pesticides may be made available only to licensed dealers and certified applicators.
7. Pesticides must be used according to labeled directions.
8. Violation of the act is a misdemeanor subject to a maximum fine of \$500, and may result in revocation of the person's certification or license.

Self-Help Questions on Section 1 – Laws and Regulations

Now that you have studied the section, answer the following questions. Write the answers in pencil without referring back to the text. When you are satisfied with your written answers, see if they are correct by checking them in the text. Erase and write in the correct answer if your first answer is wrong.

1. *What three points of this Federal Insecticide, Fungicide and Rodenticide Act (FIFRA) will most concern you?*
2. *What agency of the state government will administer the provisions of the new act?*
3. *Will pesticides be classed as "general use" only if they pose little or no threat to the environment when used as directed on the label?*
4. *Can a "restricted use" pesticide be used by an uncertified person working under the direction of a certified applicator?*
5. *What does the word certified mean with regard to a private applicator of pesticides?*
6. *Who is responsible for the proper use of a pesticide?*
7. *Can violations of the FIFRA regulations result in criminal penalties for the offender?*
8. *Is it legal to transport pesticides across state lines in a vehicle that is also carrying food products?*
9. *Are aerial applicators regulated both by the Federal Aviation Administration and by the state?*
10. *Must you report cases of severe poisoning to the Federal Occupational Safety and Health Administration if you employ five people?*

11. *What does the term residue mean with regard to pesticides?*
12. *Where can you find information on how many days before harvest you can apply a pesticide and still avoid an excessive residue on the crop?*
13. *What does the term tolerance mean with regard to pesticides?*
14. *Who has authority to certify applicators in the State of Michigan?*
15. *Who is required to be certified?*
16. *Who is required to be licensed to apply pesticides?*
17. *Are persons under the control and supervision of a certified applicator required to be certified?*
18. *Who can obtain restricted use pesticides?*
19. *Is it illegal to use a pesticide for purposes other than the labeled use?*
20. *Can a person's certification be revoked for a violation of the Michigan Pesticide Control Act?*

SECTION 2: Pests

The first step in solving any problem is to understand what is causing it. So the first step in your job is to recognize the pests you need to control.

We favor certain plants and animals that provide us food and fiber. But we also provide good growing conditions for other plants and animals that harm them. These living things that compete with us for food and fiber, or attack us directly, are *pests*. The living plant or animal a pest depends on for survival is called the *host*.

Pests can be put into six main groups:

- insects (plus mites, ticks, and spiders),
- snails and slugs,
- vertebrates,
- weeds,
- plant disease agents, and
- nematodes.

Most applicators know most of the pests they see on the job. But sometimes unfamiliar pests may appear. You can get identification aids, publications, and pictures to help find out what they are. But the best thing to do is to contact local experts. Ask your county Extension agricultural agent or other competent consultants to help you.

INSECTS

Insects thrive in more environments than any other group of animals. They live not only on the earth's surface but within the soil and in water. They are at home in deserts, rain forests, hot springs, snow fields, and dark caves. They eat the choicest foods of man's table. They can even eat the table.

Many types of insects affect crops. They cause damage in a variety of ways. They may:

- feed on leaves,
- tunnel or bore in stems, stalks, and branches,
- feed on or tunnel in roots,
- feed on and in seeds and nuts,
- suck the sap from leaves, stems, roots, fruits, and flowers, and
- carry plant disease agents.

The plants are damaged, weakened, or killed by such insect action. This causes reduced yields, lowered quality, and ugly plants or plant products that cannot be sold. Even after harvest, insects continue their damage in the stored or processed

products. Insects also feed on and in man and other animals. Some of these pests carry disease agents which have caused millions of deaths to man and livestock.

Not all insects are pests. Some help man by doing such things as pollinating plants or feeding on other insects that are pests.

Recognizing Common Features of Insects

All adult insects have two things in common — they have six jointed legs and three body regions. But how do you tell one insect from another? The most important parts to look at are *wings* and *mouthparts*. Some insects have no wings. Others have two or four. The wings vary in shape, size, thickness, and structure. Insects with chewing mouthparts have toothed jaws that bite and tear the food. Insects with piercing-sucking mouthparts have a long beak which they force into a plant or animal to suck out fluids or blood.

Almost all insects change in shape, form, and size during their lives. This change is called metamorphosis.

Some insects change only in size as they develop. The adult lays eggs. A *nymph* which looks like a tiny adult hatches from the egg and goes through several stages. These nymphs change into wingless adults. The silverfish is an example of this type of insect.

Some insects change form slightly. Their nymphs hatch from eggs. These nymphs, which have no wings, go through several growing stages. They change into winged adults. Grasshoppers are examples of such insects.

Other insects change completely. They go through four stages. The *larva* hatches from an *egg*. The larva is also called a worm, caterpillar, grub or maggot. This is the stage in which these insects grow the most and do the most damage. When full-grown, the larva changes into a *pupa*. During the pupal stage it changes into the *adult*. The adult stage usually has wings. Butterflies are well-known examples of these insects.

Here are the insect groups that include most of the insects that man considers pests. You should be familiar with the characteristics of each group that you control and the type of damage each group does.

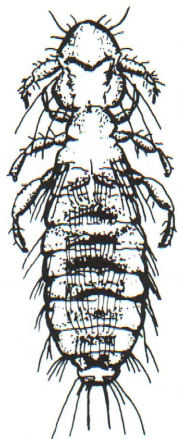

Chewing lice: No wings; chewing mouthparts; broad head; young and adult look alike; usually found on birds, poultry and livestock. They cause skin irritation and reduced weight gain and reduced milk and egg production.

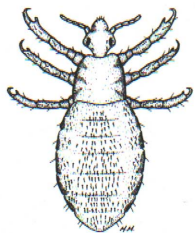

Sucking lice: No wings; piercing-sucking mouthparts; narrow head; young and adults look alike; some feed on livestock; their bites may be painful and cause itching.

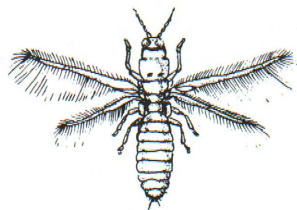

Thrips: Some have fringed wings, others have no wings; rasping (combination of chewing and sucking) mouthparts; young and adults look alike; usually found in flowers or buds of plants; may cause misshapen or poorly developed flowers, buds, fruits, heads, and leaves.

Grasshoppers and crickets: Most have wings, but are not fully developed: top pair of wings is leathery; chewing mouthparts; young and adults look alike, but young lack wings; grasshoppers usually feed on plant leaves and stems; crickets are found in the field. They eat almost anything made from plants.

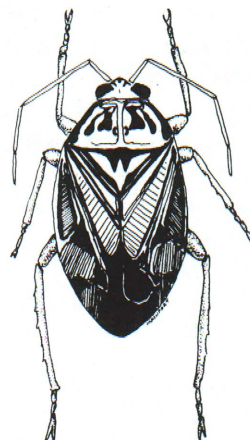

True bugs: Some have wings, some do not; top pair of wings is partly leathery and partly transparent; piercing-sucking mouthparts, young and adults look alike, but young lack wings; suck the juice from plants; reduce the vitality and yield of plants, and may carry plant disease agents; tarnished plant bugs are in this group.

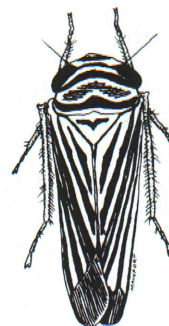

Aphids, leafhoppers, spittlebugs and scale insects: Some have wings, some do not; piercing-sucking mouthparts; young of aphids, leafhoppers, and spittlebugs look like the adults; adult scale insects are scale-covered and stay in one place on the plant; suck the juices from plants; reduce the vitality and yield of plants; some carry plant disease agents.

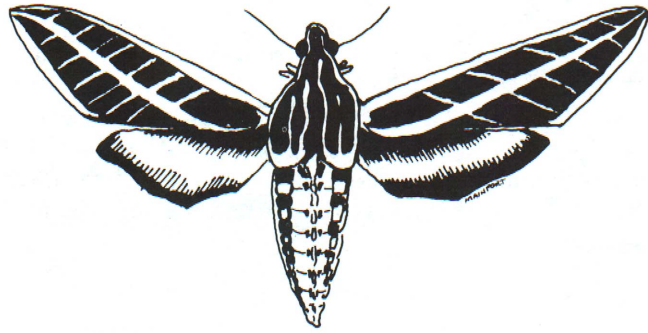

Moths and butterflies: Many adults have four large wings with some scales that rub off easily; most moths are a dull brown color, butterflies are brightly colored; mouthparts of some adults are lacking or are a coiled tube used for sucking; larvae are caterpillars, usually with six jointed legs and ten soft, fleshy legs; larvae have chewing mouthparts. Larval stages are important pests on many crops: they damage leaves, stems, tubers, and fruit.

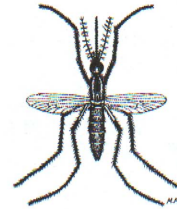

Flies and mosquitoes: Adults have only two wings (other winged insects have four); mouthparts of adults piercing-sucking, but may be slightly modified for sponging, rasping, or cutting; young (except mosquitoes) are called maggots; head of young usually not well-defined; mouthparts are small, dark, and hooklike; immature mosquitoes live in water; they have a well-developed head with chewing mouthparts; maggots usually feed on plant seedlings and roots, in organic matter, in water, and in other damp places; some maggots (cattle grubs and wool maggots) feed on animals; some adults carry disease agents; some flies or mosquitoes when in large numbers can reduce the production efficiency of animals.

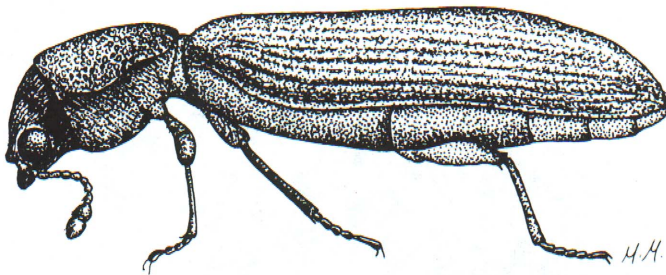

Beetles: Two top wings on adults usually hard and shiny and the bottom wings transparent; chewing mouthparts; young are grubs, larvae, or worms — some have no legs, others have six; young and adults are found on plants or in soil; both the adult and larval stages may damage stored food products, plants, and, in some cases, animals and animal products.

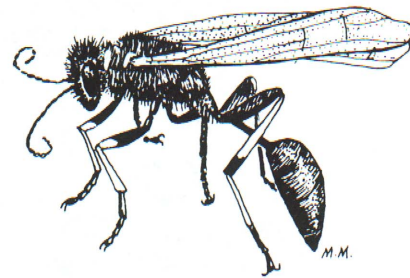

Bees, wasps, ants and sawflies: Most adults have a narrow waist, sawflies are an exception; some have four wings, some have none; chewing mouthparts; most immatures are wormlike with no legs; immature sawflies are caterpillarlike; most home in nests in soil, or in nests made of mud, paper, or wax. Painful sting of many adults makes some of these a pest; others may damage wood products.

MITES, TICKS AND SPIDERS

Mites, ticks and spiders are closely related to insects. The main differences are that the adults have eight jointed legs instead of six and have two body regions instead of three. They do not have wings.

Recognizing Common Features of Mites, Ticks, and Spiders

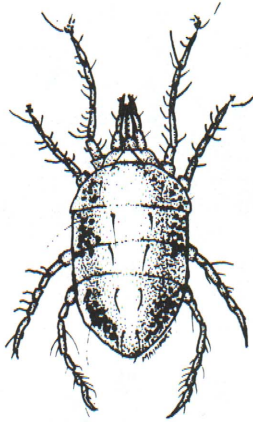

Mites: Adults and nymphs have eight legs, larvae have six; very small — about the size of the period at the end of this line. No wings; piercing-sucking mouthparts; soft-bodied; injury they cause usually is noticed before the mites are found; when present on plants in large numbers, their feeding turns foliage and buds whitish, reddish, or brown; some may scar fruit; some mites make thin webs on plants; on animals, they cause severe skin irritation, redness, scabs, and scaliness; chiggers (also called jiggers and red bugs) which attack man are mites.

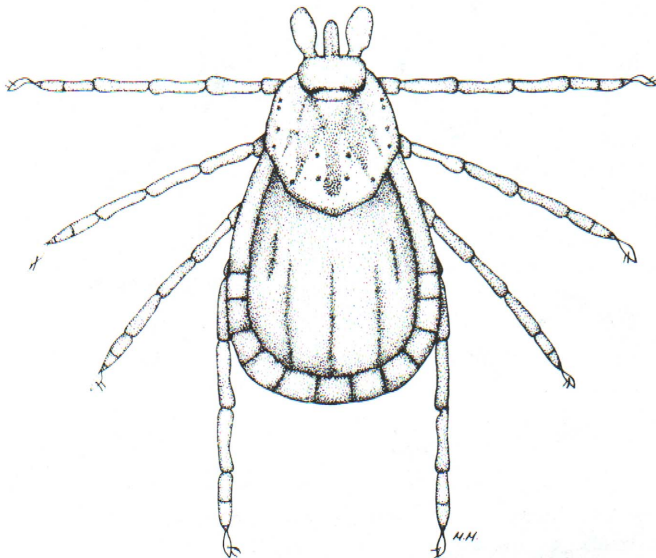

Ticks: Adults and nymphs have eight legs, larvae have six; leathery or soft (sometimes colored) body without a distinct head; piercing-sucking mouthparts with which they firmly attach themselves to the host animal; parasitic on birds and animals, including man; must have blood to complete their life cycle; some carry disease agents to man and animals.

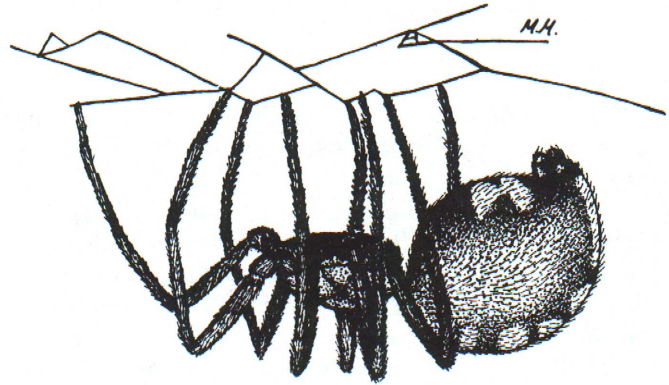

Spiders: Eight legs; biting mouthparts; vary in length from a fraction of an inch to five or six inches; useful to man because they eat insects, but webs and excretions may be a nuisance; black widow and brown recluse bites are dangerous to man.

SNAILS AND SLUGS

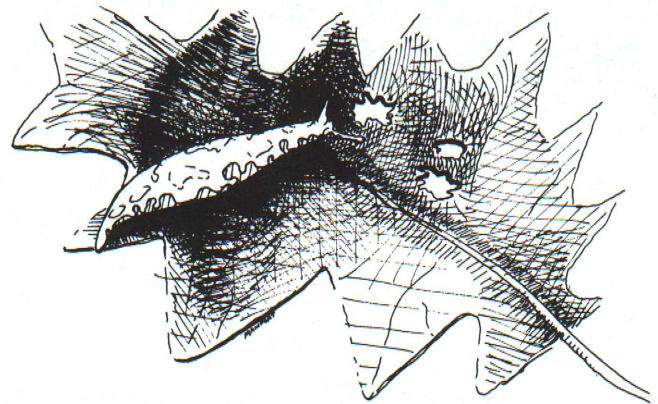

Snails and slugs are members of a large group of animals called mollusks. Snails have a hard shell; slugs have no shell. They feed on plant foliage. They are pests in lawns, landscape plantings, greenhouses, and crops.

RECOGNIZING COMMON FEATURES OF VERTEBRATES

All vertebrate animals have a jointed backbone. Vertebrates include fish, snakes, turtles, alligators, lizards, frogs, toads, salamanders, birds, and mammals. What may be a pest animal in some situations may be highly desirable in others. A muskrat, for instance, is a fur-bearing animal, but its burrows may weaken man-made earthen dams.

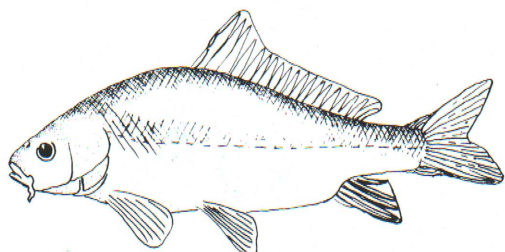

Fish

Man has caused most fish problems. We have put some kinds where they normally would not be. We think some fish are undesirable because they are not useful for sport or for food. Others compete with more desirable species. Some fish are intermediate hosts for parasites of man.

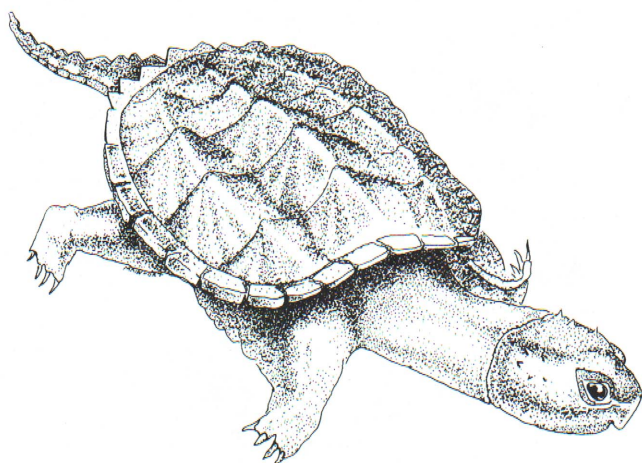

Reptiles and Amphibians

Reptiles (snakes, lizards, turtles, and alligators) and amphibians (frogs, toads, and salamanders) may cause local problems. Although most of them do little damage, many people fear or dislike them. Poisonous snakes can be a real problem. So can snakes and turtles in fish hatcheries or waterfowl production areas.



Birds

Bird damage is quite varied. It includes:

- structural damage by woodpeckers,
- destruction of feed and of fruit, nut, grain, timber, and vegetable crops by seed- and fruit-eating birds,
- hazards to animal and human health caused by birds like pigeons and parakeets, and
- annoyance caused by birds roosting near dwellings.

Peck marks, tracks, feathers, and droppings are signs of bird damage.

Mammals

Damage by mammals is varied. Some cause serious health problems to livestock and humans. Disease agents mammals transmit to man cause rabies, plague, food poisoning and tularemia. Killing of other animals by mammals is costly. Some damage fruit, vegetable, nut, grain, range, and tree crops. The damage they do to dams and ditches can be very costly. They damage such things as lawns, clothing, furniture, and buildings by gnawing and burrowing. Mice and rats annoy by living in our homes, offices and factories.

How do you tell what mammal caused the damage? You can eliminate some suspects if you know:

- which animals are found in your part of the state,
- what kinds of places they live in, and
- what their habits are.

Animal signs (tracks, droppings, toothmarks, diggings, burrows, hair, and scent) plus the type of damage will give you further clues.

WEEDS

A weed is simply "a plant out of place." Weeds are a problem because:

- they reduce crop yields;
- they increase costs of production;
- they reduce quality of crop and livestock products;
- some cause skin irritation and hay fever; some are poisonous to man, his livestock, and wildlife; and they spoil the beauty of turf and landscape plants.

Recognizing Common Features of Weeds

Before you can control weeds, you need to know something about how they grow. One important feature is the length of their life cycle.

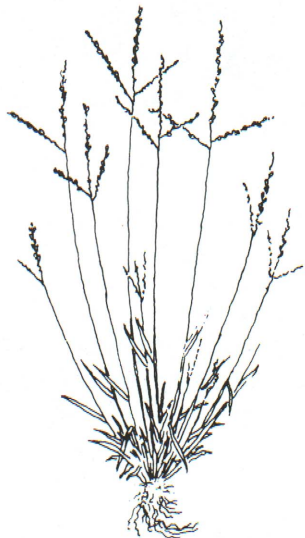

Annuals: Plants with a one-year life cycle are *annuals*. They grow from seed, mature, and produce seed for the next generation in one year or less. They may be grasslike (crabgrass and foxtail) or broad-leaved (pigweed and cocklebur).



Summer annuals are plants that result from seeds which sprout in the spring. They grow, mature, produce seed and die before winter. Examples: crabgrass, foxtail, cocklebur, pigweed and lambsquarters.

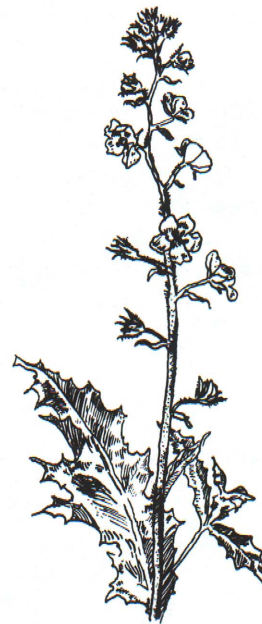

Winter annuals are plants that grow from seeds which sprout in the fall. They grow, mature, produce seed and die before summer. Examples: cheat, henbit and annual bluegrass.



Biennials: Plants with a two-year life cycle are *biennials*. They grow from seed and develop a heavy root and compact cluster of leaves the first year. In the second year they mature, produce seed and die. Examples: mullein, burdock and bull thistle.

Perennials: Plants which live more than two years and may live indefinitely are *perennials*. During the winter, many lose their foliage and the stems of others may die back to the ground. Some grow from seed. Others produce tubers, bulbs, rhizomes (below-ground rootlike stems) or stolons (above-ground stems and produce roots). Examples: field bindweed, dandelion and plantain.



Creeping perennials produce seeds but also produce rhizomes and stolons. Examples: Bermuda grass and field bindweed.

Simple perennials normally reproduce by seeds. But root pieces may produce new plants following mechanical injury during cultivation. Examples: dandelions, plantain, trees and shrubs.



Bulbous perennials may reproduce by seed, bulblets, or bulbs. Wild garlic, for example, produces seed and bulblets above ground and bulbs below ground.

RECOGNIZING COMMON FEATURES OF PLANT DISEASES

A plant disease is any harmful condition that makes a plant different from a normal plant in its appearance or function. Plant diseases are divided into two groups based on their cause.

Nonparasitic Plant Diseases

These are caused by nonliving agents. The causes can include such things as:

- nutrient deficiency,
- extreme cold or heat,
- toxic chemicals (air pollutants, some pesticides, salts, too much fertilizer),
- mechanical injury, and
- lack of or too much water.

These diseases cannot be passed from one plant to another.

Parasitic Plant Diseases

These are caused by living agents which live and feed on or in plants. They can be passed from one plant to another. The most common causes of parasitic diseases are:

- fungi,
- bacteria,
- viruses, and
- nematodes.

Three things are required before a parasitic disease can develop:

1. a susceptible host plant,
2. a parasitic agent, and
3. an environment favorable for parasite development.

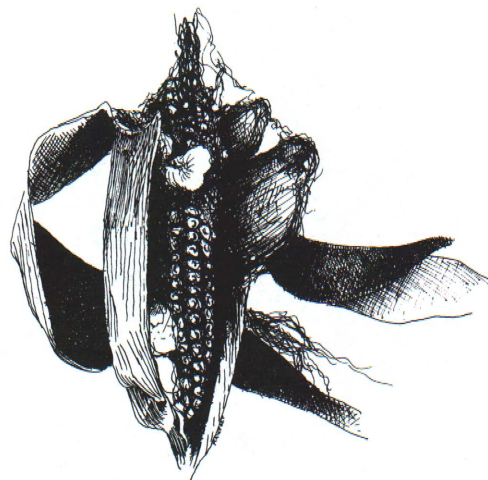

Fungi: These are plants that lack green color (chlorophyll). They cannot make their own food. There are more than 100,000 kinds of fungi of

many types and sizes. Not all are harmful, and many are helpful to man. Many are microscopic, but some, such as the mushrooms, may be quite large. Most fungi reproduce by spores, which function about the same way seeds do. Fungi may attack a plant both above and below the soil surface.

Fungus diseases include apple scab, anthracnose of beans, smut in corn and powdery mildew on landscape plants.



Bacteria: These are microscopic, one-celled plants. They usually reproduce by simply dividing in half. Each half becomes a fully developed bacterium. Bacteria can build up fast under ideal conditions. Some can divide every 30 minutes. Fire blight of pears, halo blight of beans and bacterial leaf spot on peaches are caused by bacteria.

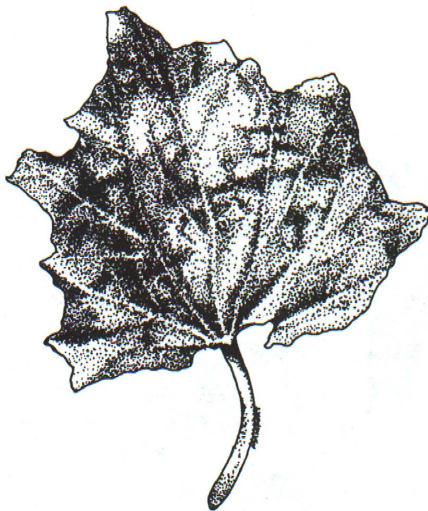

Viruses: These are so small that they cannot be seen with the unaided eye or even with an ordi-

nary microscope. They are generally recognized by their effects on plants. Many viruses that cause plant disease are carried by insects, usually aphids or leafhoppers. Viruses are easily carried along in bulbs, roots, cuttings, and seeds. Some viruses are transmitted when machines or men touch healthy plants after touching diseased plants. A few are transmitted in pollen. At least one virus is transmitted by fungus. A few are transmitted by nematodes. Wheat streak mosaic, tobacco mosaic and corn dwarf are diseases caused by viruses.

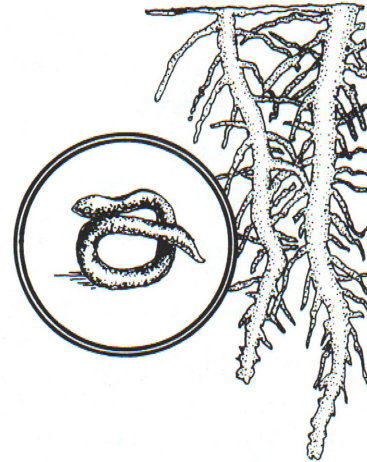

Nematodes: These are small, usually microscopic, roundworms, also called eelworms. Many nematodes are harmless. Others may attack crops planted for food, fiber or landscape purposes. Some species attack the above-ground plant parts, such as leaves, stems and seeds. But most species feed on or in the roots. They may feed in one location, or they may constantly move through the roots. Nematodes usually do not kill plants, but reduce growth and plant health. They may weaken the plant and make it susceptible to other disease agents.

All nematodes that are parasites on plants have a hollow feeding spear. They use it to puncture plant cells and feed on the cell contents. Nematodes may develop and feed either inside or outside of a plant. Their life cycle includes an egg, four larval stages, and an adult. Most larvae look like adults, but are smaller. The females of some, such as root knot and cyst nematodes, become fixed in the plant tissue. Their bodies become swollen and rounded. The root knot nematode deposits its eggs in a mass outside of its body. The cyst nematode keeps part of its eggs inside its body after death. They may survive there for many years.

Development of Plant Diseases

A parasitic disease depends on the life cycle of the parasite. The environment affects this cycle greatly; temperature and moisture are especially important. They affect:

- the activity of the parasite,
- the ease with which a plant becomes diseased, and
- the way the disease develops.

The disease process starts when the parasite arrives at a part of a plant where infection can occur. This step is called *inoculation*. If environmental conditions are good, the parasite will begin to develop. This stage before injury develops is called *incubation*. If the parasite can get into the plant, the stage called *infection* starts. The plant is diseased when it responds to the parasite.

The three main ways a plant responds are:

1. overdevelopment of tissue, such as galls, swellings and leaf curls,
2. underdevelopment of tissue, such as stunting, lack of chlorophyll and incomplete development of organs, and
3. death of tissue, such as blights, leaf spots, wilting and cankers.

Identifying Plant Diseases

You cannot always tell one plant disease from another just by looking at the plant itself. Because many disease agents cause similar injury, you need other evidence. Identifying the cause is a better way to identify the disease. You usually need a microscope or magnifying lens to see such things as fungus spores, nematodes or their eggs, and bacteria. You need more training to find and identify the cause of a disease than you need to observe the effects.

Self-Help Questions on Section 2 – Pests

Now that you have studied the section, answer these questions. Write the answers with pencil without referring back to the text. When you are satisfied with your written answers, see if they are correct by checking them in the text. Erase and write in the correct answer if your first answer is wrong.

1. *What is the first essential step in pest control?*
2. *What is meant by the host of a pest?*
3. *Name the six main groups of pests.*
4. *Who should you contact for identification of a pest that you cannot identify?*
5. *How can insects cause damage?*
6. *Are all insects pests of man?*
7. *How many legs and how many body regions do insects have?*
8. *What two parts of an insect are most important in identifying the insect?*

9. *What does the word metamorphosis mean?*
10. *Do insect nymphs have wings?*
11. *What are some other common names for larvae?*
12. *What hosts do chewing lice have?*
13. *Do sucking lice have wings?*
14. *What type of mouth parts do thrips have?*
15. *What do crickets feed on?*
16. *What kind of mouth parts do true bugs have?*
17. *Do aphids and leafhoppers carry plant disease?*
18. *How many legs do larvae (or caterpillars) or butterflies and moths have?*
19. *What is characteristic of the top wings of beetles?*
20. *How many wings do mosquitoes and flies have?*
21. *What type of mouth parts do bees, wasps, ants and sawflies have?*
22. *How many legs and how many body regions do mites, ticks and spiders have?*
23. *Are mites hard bodied or soft bodied?*
24. *Why do ticks have to feed on blood?*
25. *How are spiders useful to man?*
26. *Do slugs have a hard shell?*
27. *What are animals with a jointed backbone called?*
28. *Why are some fish considered pests?*
29. *What kind of reptiles are poisonous?*
30. *Are birds pests only because they eat seeds?*
31. *What kind of animals can carry the disease rabies?*
32. *What is a weed?*

33. *Why are weeds considered pests?*
34. *When do seeds of summer annuals sprout?*
35. *When do winter annuals produce seed?*
36. *What is a plant that lives for two years called?*
37. *Do creeping perennials produce rhizomes?*
38. *How do simple perennials normally reproduce?*
39. *Are bulbs produced above or below the ground?*
40. *What is a plant disease?*
41. *Is mechanical damage to a plant considered to be a nonparasitic disease?*
42. *Name four living agents that cause plant diseases.*
43. *What three things are required before a parasitic disease can develop?*
44. *How do most fungi reproduce?*
45. *What are bacteria?*
46. *Can viruses be seen by using an ordinary microscope?*
47. *Do nematodes usually kill their hosts?*
48. *What are the stages of the life cycle of a nematode?*
49. *What two environmental factors are especially important to the life cycle of a disease organism?*
50. *What does the word inoculation mean?*
51. *What are the three main ways that a plant may respond to parasitic disease.*

SECTION 3: Pest Control

To solve pest problems, you must:

- identify the pest,
- know what control methods are available,
- evaluate the benefits and risks of each method or combination of methods,
- choose the methods that are most effective and will cause the least harm to you and the environment,
- know the correct use of the methods, and
- know local, state, and federal regulations that apply to the situation.

PRINCIPLES OF PEST CONTROL

We often talk about the “war” against insects, plant diseases, weeds and rats. In a war between countries, would a national leader use only the army? Wouldn't he also use other tools, such as the navy, the air force, and propaganda?

Yet, in our struggle against pests, how often do we just use the handiest or cheapest pesticide? How often do we forget to consider other methods or combinations of methods? How often do we forget about effects on the environment? It may be too often.

The use of a combination of methods to control pests is basic to all pest control. Modern pest control is: (a) using all available methods to keep pests below economically harmful levels, and (b) damaging the environment as little as possible in the process.

The challenge lies in our ability:

- to control pests so that injury caused by them is held to a minimum, and
- to recognize when direct action, such as a pesticide application, is necessary.

PEST CONTROL METHODS

Many pest control methods have been known and used for years. But some methods, what we call them, and the way we put them together are new. Here are the most important pest control methods.

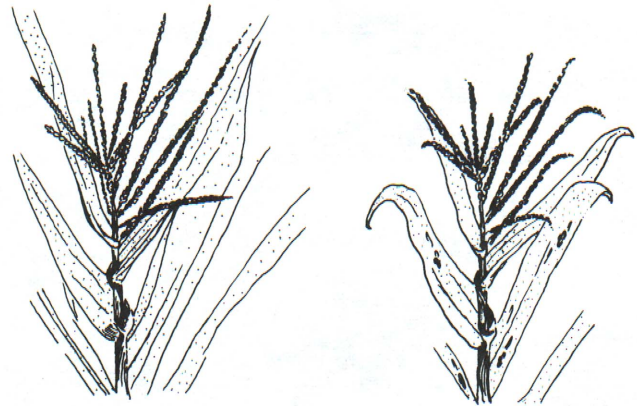

Resistant Varieties

Some crops, animals, and woods resist pests better than others. Some crops and woods are immune to certain pests. By using resistant types, we make the environment less favorable for pests. This makes it easier to keep pests below harmful levels.

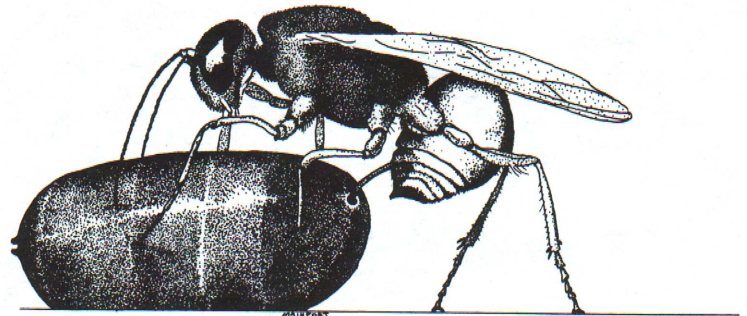

Biological Control

Biological control is most common for insects, mites, and some weeds. Biological control occurs naturally. Releasing more of a pest's natural enemies — parasites, predators and disease agents — into the target area can increase this natural control. Many pests come from other countries. Bringing in their natural enemies often helps control them.

Prevention

Prevention is keeping a pest from becoming a problem. Includes use of, or combination of, such things as:

- sanitation,
- resistant plants, animals or wood,
- treated seed,
- pesticides,
- cultural controls,
- quarantines, and
- seed certification.

Suppression

Suppression is reducing pest number or damage to an acceptable level. Includes use of, or combination of, such things as:

- sanitation,
- resistant plants, animals or wood,

- pesticides, and
- cultural controls.

Eradication

Eradication is destroying or removing a pest completely from a crop, an area or a geographic region.

Remember, the most important principle of pest control is:

Use a pest control method only when that method will prevent the pest from causing more damage than is reasonable to accept.

Even though a pest is present, it may not do very much harm. It could cost more and cause more environmental damage to control the pest than would have been lost because of the pest's damage.

Self-Help Questions on Section 3 – Pest Control

Now that you have studied the section, answer these questions. Write the answers with pencil without referring back to the text. When you are satisfied with your written answers, see if they are correct by checking them in the text. Erase your answer and write in the correct answer if your first answer is wrong:

1. *Is the use of a pesticide usually the best way to control a pest?*
2. *Should possible damage to the environment be considered in choosing a pest control method?*
3. *What is meant by a pest-resistant variety?*
4. *What is meant by natural enemy with regard to pests?*
5. *What are some common cultural controls?*
6. *What kind of a control measure is the use of light to attract or repel pests?*
7. *Can rat or fly control be effective where proper sanitation is not followed?*
8. *Is a quarantine a type of legal control for pests?*

9. *Are pesticides often needed for pest control?*
10. *What is the word to indicate the keeping of a pest from becoming a problem?*
11. *What does the word suppression mean?*
12. *How does eradication differ from suppression?*
13. *What is the most important principle of pest control? Understanding of this principle is fundamental to sound pest control.*

SECTION 4: Pesticides

After considering all available control methods, you may decide that a pesticide is needed. Here are some things you should know in order to choose the right pesticide and use it most effectively.

Pesticides are chemicals used to destroy, prevent or control pests. They also include: (a) chemicals used to attract or repel pests; and (b) chemicals used to regulate plant growth or remove or coat leaves. Here are the types and uses of pesticides:

Insecticide: controls insects and other related pests such as ticks and spiders.

Miticide: controls mites.

Acaricide: controls mites, ticks, and spiders.

Nematicide: controls nematodes.

Fungicide: controls fungi.

Bactericide: controls bacteria.

Herbicide: controls weeds.

Rodenticide: controls rodents.

Avicide: controls birds.

Piscicide: controls fish.

Molluscicide: controls slugs and snails.

Predacide: controls vertebrate pests.

Repellent: keeps pests away.

Attractant: lures pests.

Plant growth regulator: stops, speeds up, or otherwise changes normal plant processes.

Defoliant: removes unwanted plant growth without killing the whole plant immediately.

Desiccant: dries up plant leaves and stems and insects.

Antitranspirant: coats the leaves of plants to reduce unwanted water loss (transpiration).

THE NATURE OF PESTICIDES

Pesticides can be grouped according to their chemical nature. The groups are:



Inorganic Pesticides

These are made from minerals. Minerals used most often are arsenic, copper, boron, lead, mercury, sulfur, tin and zinc. Examples: lead arsenate, Bordeaux mixture, and Paris green.



Synthetic Organic Pesticides

These are man-made pesticides. They contain carbon, hydrogen and one or more other elements such as chlorine, phosphorous and nitrogen. Examples: 2, 4-D, atrazine, captan, parathion and malathion.

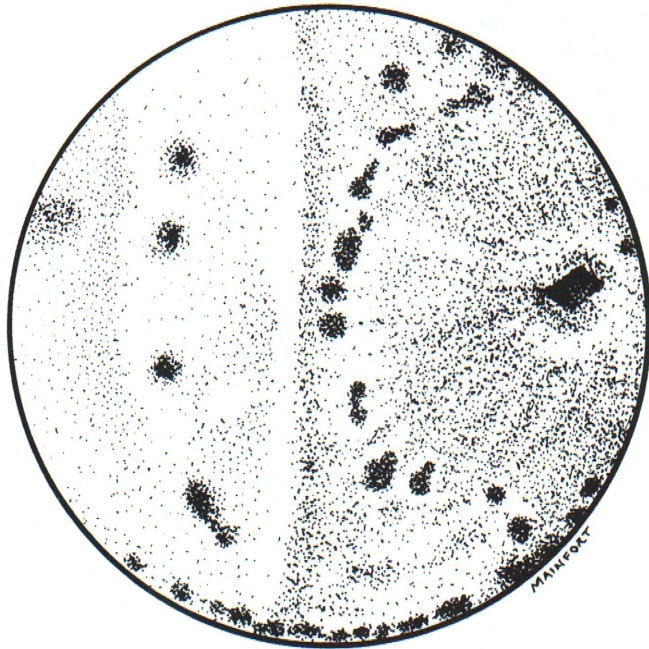

Living Micro-Organisms

These are viruses, bacteria and fungi that are produced by man. Examples: the bacterium *Bacillus thuringiensis*, and the polyhedrosis virus.



Plant-Derived Organic Pesticides

These are made from plants or plant parts. Examples: rotenone, red squill, pyrethrins, strychnine and nicotine.

HOW PESTICIDES WORK

Pesticides also can be grouped according to what they do. Many synthetic organic pesticides work in more than one way. Read the label to find out what each pesticide will do. The major groups are:

- Protectants:** applied to plants, animals and products to prevent entry or damage by a pest.
- Sterilants:** make pests unable to reproduce.
- Contact:** kill pests simply by contacting them.
- Stomach Poisons:** kill when swallowed.
- Systemics:** taken into the blood of an animal or sap of a plant. They kill the pest without harming the host.
- Translocated herbicides:** kill plants by being absorbed by leaves, stems or roots and moving throughout the plant.
- Fumigants:** gases which kill when they are inhaled or otherwise absorbed by the pest.
- Anticoagulants:** prevent normal clotting of blood.
- Selective:** more toxic to some kinds of plants or animals than to others.
- Nonselective:** toxic to most plants or animals.
- Pheromones:** affect pests by changing their behavior.

USING PESTICIDES

Many terms describe when and how to use pesticides. They are used in labeling. They also are found in leaflets and bulletins that you may get from your county Extension agricultural agent and others. You should know and understand these terms. They will help you get the best results from your pesticides with the least possible harm to you and the environment.

When to Use

Terms that tell you when to use the pesticide product:

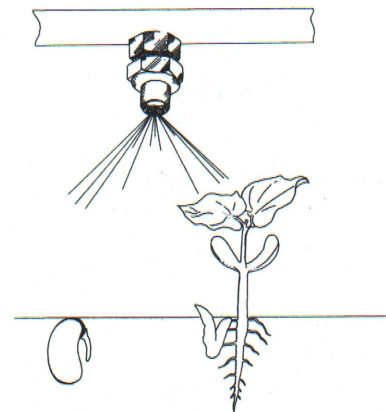

- Pre-emergence:** used before crop or weeds emerge. May also refer to use after crops emerge or are established, but before weeds emerge.

Preplant: used before the crop is planted.

Postemergence: used after the crop or weeds have emerged.

How to Use

Terms that tell you how to use the pesticide product:

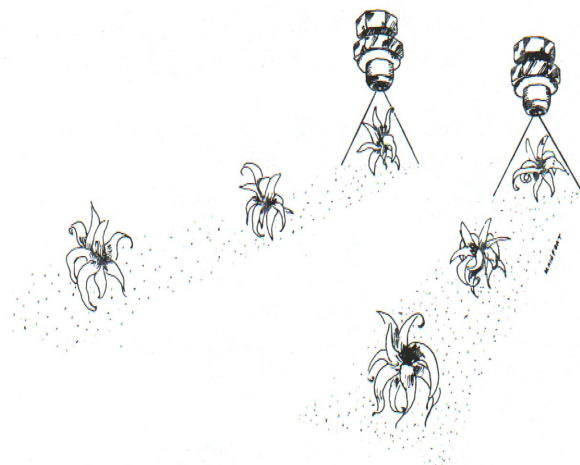

Band: application to a strip over or along a crop row or on or around a structure.

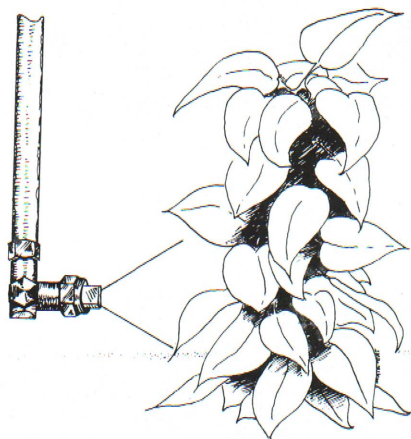

Basal: application to stems or trunks at or just above the ground line.

Broadcast: uniform application to an entire, specific area.

Dip: complete or partial immersion of a plant, animal, or object in a pesticide.

Directed: aiming the pesticide at a portion of a plant or animal.

Drench: saturating the soil with a pesticide or oral treatment of an animal with a liquid pesticide.

Foliar: application to the leaves of plants.

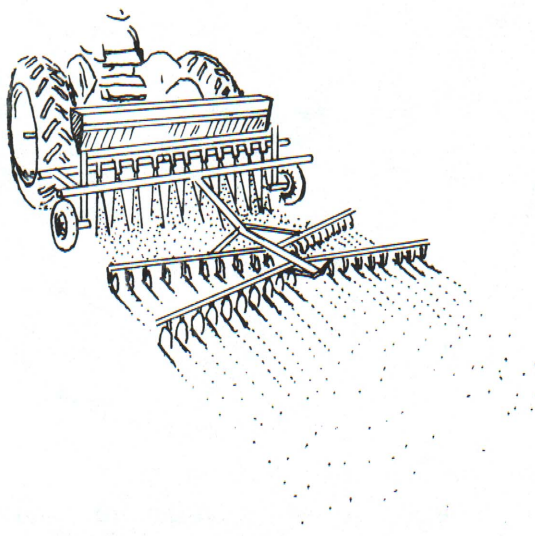

In-furrow: application to or in the furrow in which a plant is planted.

Over-the-top: application over the top of the growing crop.

Pour-on: pouring the pesticide along the midline of the back of livestock.

Sidedress: application along the side of a crop row.

Soil application: application of the pesticide to the soil.

Soil incorporation: use of tillage implements to mix the pesticide with the soil.

Soil injection: application beneath the soil surface.

Spot treatment: application to small area.

Accuracy Is Important

The *rate* and *time* of application are critical. Most pesticides work at very low rates. If you use too much, they can harm or even kill the plant or animal you wish to protect. Pesticides work best when applied at specific times. Applying them before or after the correct time reduces or even eliminates their effectiveness.

Since all these chemicals work in small amounts, be careful to treat only the intended target. Avoid getting them on anything else as a result of drift or of residue in application equipment or soil.

FACTORS AFFECTING PESTICIDE ACTIVITY

Soil Factors

Organic matter in soils limits pesticide activity. Soils with high organic matter content may need higher rates of pesticides for good pest control. Follow label instructions.

Soil texture also affects the way pesticides work. Soils with fine particles (silts and clays) provide the most surface area. They may need higher rates. Coarser soils (sands) have less surface area. Use lower rates on them. Follow label instructions.

Climatic Factors

Soil moisture and rain affect the way pesticides work. They also affect how long pesticides stay on soil and plants. Pesticides work best with moderate soil moisture. Wetness may keep the pesticide from contacting the soil particles. Rain causes soluble pesticides to leach down through the soil. Rain is good when preemergence pesticides are applied to the surface. It carries them down into the soil to the pests. But rain during or soon after over-the-top or foliar applications is not good. It may wash pesticides off the leaves.

Humidity and temperature also affect the way pesticides work. Herbicides work best when plants are growing fast. High relative humidity and optimum temperatures usually cause this fast growth. High temperatures cause some soil pesticides to evaporate quickly. Low temperatures may slow down or stop the activity of some pesticides.

Light may break down some pesticides if they are left on the soil surface for a long time.

Pesticide Resistance

The ability of pests to resist poisoning is called *pesticide resistance*. Consider this when planning pest control programs that rely on the use of pesticides.

Rarely does any pesticide kill all the target pests. Each time a pesticide is used, it selectively kills the most sensitive pests. Some pests avoid the pesticide. Others are able to withstand its effects. Pests that are not destroyed pass along to their offspring the trait that allowed them to survive.

When we use one pesticide repeatedly in the same place, the pest population sometimes builds up its resistance. Some pests have become practically immune to poisoning by certain pesticides.

Not every pesticide failure is caused by pest resistance, however. Make sure that you have:

1. used the correct pesticide,
2. used the correct dosage,
3. applied the pesticide correctly, and
4. applied the pesticide at the right time.

Your county Extension agricultural agent can help you find out why you did not get the desired results.

PLANT GROWTH REGULATORS, DESICCANTS, DEFOLIANTS AND ANTITRANSPIRANTS

Plant growth regulators, desiccants, defoliants and antitranspirants change normal plant processes.



Plant Growth Regulators

All plant parts are made up of tiny cells which continually multiply and grow. Plant growth regulators speed up, slow down, or otherwise affect cell growth and reproduction. Here are some ways they are used:

- decrease preharvest drop,
- increase fruit firmness,
- reduce scald,
- delay water core (water-soaked area around core of fruit),
- increase red color,
- thin fruit,
- increase flowering,
- reduce fruit cracking,
- promote uniform bearing of fruit,
- control plant height,

- prevent or delay sprouting of tubers,
- promote earlier flowering,
- prevent seed formation,
- induce branching,
- reduce suckering,
- hasten fruit maturity,
- increase seed yield, and
- control excessive growth.

Desiccants and Defoliants

These often are called harvest-aid chemicals because they help the farmer harvest his crop. Both are used to get rid of leaves, stems, and weeds in such crops as soybeans and potatoes.

Antitranspirants

By reducing water loss, they can:

- prevent winter damage,
- maintain color in evergreens,
- protect against salt damage,
- help protect transplants, and
- prevent needle drop on Christmas trees.

TYPES OF FORMULATIONS

Active ingredients are the chemicals in a pesticide product that do the work. Active ingredients can rarely be used in the form in which they were made. They usually must be changed or mixed with something else. Other ingredients may be added to make them convenient to handle and safe, easy and accurate to apply. These are the inert ingredients. This mixture of active and inert ingredients is called a *pesticide formulation*. Some formulations are ready for use. Others must be diluted with water or a petroleum solvent. The directions for use will tell you how to use a pesticide formulation.

Here are the most common types of liquid and dry formulations. The abbreviations are included because Cooperative Extension Service recommendations and the labels and labeling may refer to the formulations in this way.

Liquid Formulations

Emulsifiable concentrates (EC or E): An emulsifiable concentrate can be mixed with water to form an emulsion. Each gallon of an EC usually contains two to eight pounds of active ingredient. Diluted EC's usually need little agitation in the spray tank.



EC's can damage some crops. These crops may require a different formulation of the active ingredient such as a wettable powder or a dust.



Solution (S): There are two types of solutions:

1. *High concentrates* are special formulations. They usually contain eight or more pounds of active ingredient per gallon. They may contain only the active ingredient itself. Most are designed to be used as is or diluted with oil or petroleum solvents. They contain chemicals that allow them to spread and stick well. Ultra low volume (ULV) concentrate materials should be used without further dilution.
2. *Low concentrates* usually contain less than two pounds of active ingredient per gallon. Most of them are solutions in highly refined oils. They need no further dilution. The label will give you directions for use. They are often used for:
 - controlling household and industrial pests,
 - mothproofing,
 - livestock sprays, or
 - space sprays in barns.



Flowables (F or L): Some active ingredients can be made only as a solid, or at best, a semisolid. These are finely ground and put into a liquid along with other substances that make the mixture form a suspension. They are *flowable solids*. Flowables can be mixed with water. They seldom clog spray nozzles. They need only moderate agitation. Most of them handle as well as EC formulations.

Aerosols (A): These pesticide formulations are liquids that contain the active ingredient in solution in a solvent. More than one pesticide may be in these formulations. Most aerosol formulations have a low percentage of active ingredient. They are made for use only in fog- or mist-generating machines. They are used in structures, greenhouses, and barns for insect control.

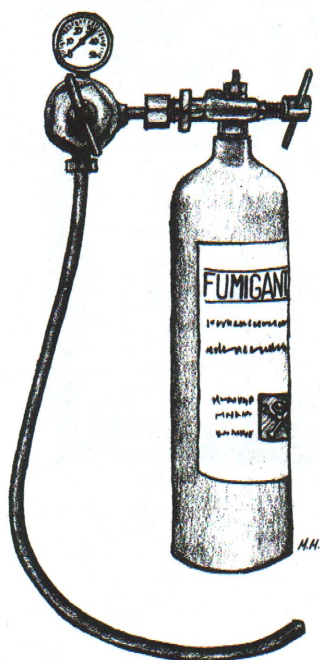

Fumigants: Some fumigants are gases which become liquid when placed under pressures. This type of formulation is stored under pressure. The

pressure may be either high or low, depending on the product. Some nematicides, insecticides, fungicides, and rodenticides are formulated this way. These formulations are applied by:

- injecting them directly into the soil,
- releasing them under tarps, or
- releasing them into a structure such as a grain storage elevator.

Some other active ingredients remain liquid in an ordinary container, but turn into a gas or vapor as or after they are applied. These formulations do not require storage under pressure. They must be put into the soil or confined in a space before they turn to gas. Otherwise, they could be lost into the air.

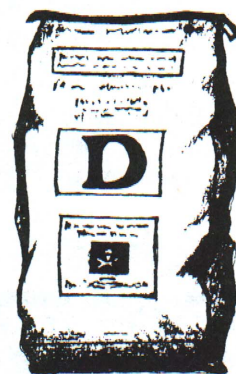

Dry Formulations

Dusts (D): Most dust formulations are ready to use and contain: (a) an active ingredient; plus (b) a very fine or powdered dry inert substance such as talc, clay, nut hulls, or volcanic ash.

The amount of active ingredient usually ranges from 1 to 10 percent. All the ingredients are ground into fine, uniform particles. Inert ingredients are often added so the formulation will store and handle well. Some active ingredients are prepared as dusts because they are safer for crops in that form. Dusts always must be used dry. They can usually drift into nontarget areas. You can get dusts for use on seeds, plants, and animals.

Granules (G): Granular formulations are dry. Most are made by applying a liquid formulation of the active ingredient to coarse particles (granules) of some porous material. Often used are clay, corn cobs, or walnut shells. Granule particles are much larger than dust particles. The pesticide is absorbed into the granule, or coats the outside of it, or both. Inert ingredients may be added to make the formulation handle well. The amount of active ingredient ranges from 2 to 40 percent. Granular formulations are safer to apply than EC's or dusts. They are most often used as soil treatments. They

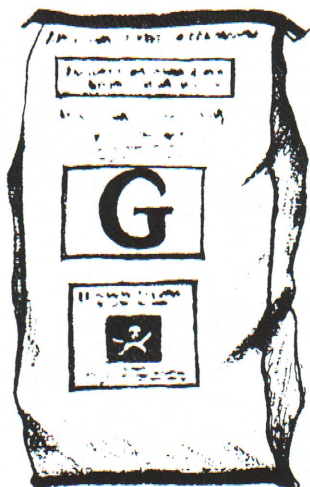

may be applied either directly to the soil or over plants. They do not cling to plant foliage, but they may be trapped in the whorls of some plants. Granular formulations, like dusts, should always be used dry. Never mix them with water.



Soluble powders (SP): Soluble powders also are dry formulations. But when they are added to water, they form true solutions. Agitation in the spray tank may be needed to get them to dissolve. After that, no more agitation usually is needed. The amount of active ingredient in an SP is usually above 50 percent.

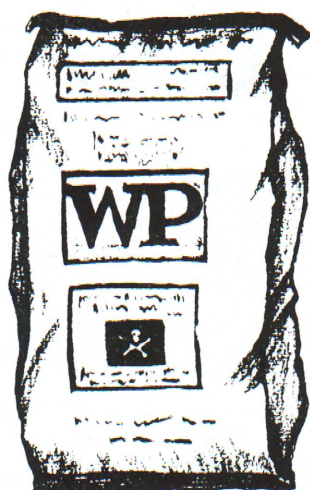

Wettable powders (WP or W): These are dry, finely ground pesticide formulations. They look like dusts. But, unlike dusts, they are made to mix with water. Most wettable powders are much more concentrated than dusts. They contain 15 to 95 percent active ingredient — usually 50 percent or more. Wettable powders form a suspension rather than a true solution when added to water. Good agitation is needed in the spray tank to maintain the suspension. Good wettable powders spray well and do not clog nozzles. However, they are abrasive to pumps and nozzles. Most wettable powders are safer for use on plants than EC's.

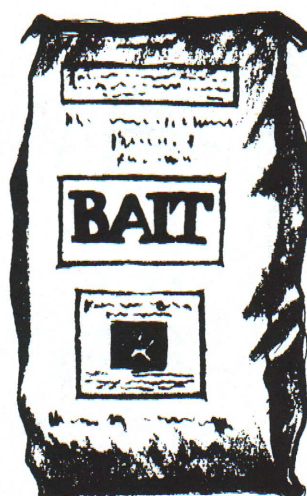

Baits (B): A bait formulation is an edible or attractive substance mixed with a pesticide. The bait attracts pests and the pesticide kills them when they eat the formulation. Baits usually are used to control rodents and insect pests. They can be used in buildings or outdoors. The amount of active ingredient in most bait formulations is quite low, usually less than 5 percent.

Self-Help Questions on Section 4 – Pesticides

Now that you have studied the section, answer these questions. Write the answers with pencil without referring back to the text. When you are satisfied with your written answers, see if they are correct by checking them in the text. Erase your answer and write in the correct answer if your first answer is wrong.

1. *Are chemicals used to regulate plant growth considered to be pesticides?*
2. *What type of pest is controlled by an acaricide?*
3. *Are pesticides made from minerals called organic pesticides?*
4. *Are synthetic organic pesticides man-made?*
5. *Are living microorganisms used for pest control considered to be pesticides?*
6. *Can some pesticides be made from plants?*
7. *What is a nonselective pesticide?*
8. *Are postemergence applications made before or after the crops or weeds have emerged?*
9. *Are foliar applications made to the leaves of plants?*
10. *How can too much pesticide be harmful to a crop?*
11. *Is the timing of a pesticide application important to control of the pest?*
12. *Name two soil factors that influence the activity of soil pesticides.*
13. *Name three climatic factors that influence the activity of pesticides.*
14. *What is meant by pesticide resistance of a pest?*
15. *What are possible causes of failure of a pesticide other than pesticide resistance?*
16. *Name some ways that plant growth regulators are used in crop production.*
17. *What is meant by active ingredient in a pesticide product?*
18. *Why are inert ingredients included in a pesticide product?*

19. *What is the mixture of active and inert ingredients called?*
20. *Can emulsifiable concentrate pesticides mix with water for use?*
21. *What type of formulation is used for ultralow volume sprays?*
22. *What formulation consists of a finely ground solid suspended in a liquid?*
23. *Are aerosols usually used to treat crops in the field?*
24. *Are fumigants effective against pests as solids, liquids or gases?*
25. *Can dust formulations be mixed with water for use?*
26. *How do granule formulations differ from dusts?*
27. *How do wettable powder formulations affect pumps and nozzles?*
28. *How does a soluble powder differ from a wettable powder?*
29. *What is a formulation of an edible or attractive substance mixed with a pesticide called?*

SECTION 5: Labels and Labeling

Each time you buy a pesticide, you also receive instructions to tell you how to use it. Those instructions are the labeling.

What is labeling? What is a label? These words seem alike but they do not mean the same thing.

Labeling is all information that you receive from the company or its agent about the product. Labeling includes such things as:

- the label on the product,
- brochures,
- flyers, and
- information handed out by the dealer.

The *label* is the information printed on or attached to the container of pesticides. This label does many things:

1. To the buyer or user, the label is a main source of facts on how to use the product correctly and legally.
2. The label is a way to tell users about special safety measures needed.
3. To the manufacturer, the label is a "license to sell."
4. To the state or federal government, the label is a way to control the distribution, storage, sale, use and disposal of the products.

Some labels are easy to understand. Others are complicated. But all labels will tell you how to use the product correctly. This section will explain the items that must be on a label.

<div style="border: 1px solid black; padding: 5px; margin-bottom: 5px;"> <p style="text-align: center; font-size: small;">PRECAUTIONARY STATEMENTS HAZARDS TO HUMANS (& DOMESTIC ANIMALS) DANGER</p> <p>_____</p> <p>_____</p> <p>_____</p> </div> <div style="border: 1px solid black; padding: 5px; margin-bottom: 5px;"> <p style="text-align: center; font-size: small;">ENVIRONMENTAL HAZARDS</p> <p>_____</p> <p>_____</p> <p>_____</p> </div> <div style="border: 1px solid black; padding: 5px; margin-bottom: 5px;"> <p style="text-align: center; font-size: small;">PHYSICAL OR CHEMICAL HAZARDS</p> <p>_____</p> <p>_____</p> <p>_____</p> </div> <p style="font-size: small;">DIRECTIONS FOR USE It is a violation of Federal law to use this product in a manner inconsistent with its labeling.</p> <p style="font-size: small;">RE-ENTRY STATEMENT (If Applicable)</p> <p>_____</p> <p style="font-size: small;">CATEGORY OF APPLICATOR</p> <p>_____</p> <div style="border: 1px solid black; padding: 5px; margin-bottom: 5px;"> <p style="text-align: center; font-size: small;">STORAGE AND DISPOSAL</p> <p>STORAGE _____</p> <p>DISPOSAL _____</p> </div> <p style="font-size: small;">CROP: _____</p> <p>_____</p> <p>_____</p>	<div style="border: 1px solid black; padding: 10px; margin-bottom: 10px;"> <p style="font-size: large; font-weight: bold;">RESTRICTED USE PESTICIDE</p> <p style="font-size: x-small;">FOR RETAIL SALE TO AND APPLICATION ONLY BY CERTIFIED APPLICATORS OR PERSONS UNDER THEIR DIRECT SUPERVISION</p> </div> <p style="font-size: x-large; font-weight: bold; margin: 10px 0;">PRODUCT NAME</p> <p style="font-size: small;">ACTIVE INGREDIENT: _____ % INERT INGREDIENTS: _____ % TOTAL: _____ 100.00 %</p> <p style="font-size: small;">THIS PRODUCT CONTAINS LBS OF PER GALLON</p> <div style="border: 1px solid black; padding: 10px; margin: 10px 0;"> <p style="font-weight: bold; text-align: center;">KEEP OUT OF REACH OF CHILDREN DANGER — POISON</p> <div style="text-align: center; margin: 5px 0;"> </div> <p style="font-size: x-small; text-align: center;">STATEMENT OF PRACTICAL TREATMENT</p> <p>IF SWALLOWED _____</p> <p>IF INHALED _____</p> <p>IF ON SKIN _____</p> <p>IF IN EYES _____</p> <p style="font-size: x-small; text-align: center;">SEE SIDE PANEL FOR ADDITIONAL PRECAUTIONARY STATEMENTS</p> <p style="font-size: x-small;">MFG BY _____</p> <p style="font-size: x-small;">TOWN, STATE _____</p> <p style="font-size: x-small;">ESTABLISHMENT NO. _____</p> <p style="font-size: x-small;">EPA REGISTRATION NO. _____</p> <p style="font-size: x-small;">NET CONTENTS _____</p> </div>	<p style="font-size: x-small;">CROP: _____</p> <p>_____</p> <p>_____</p> <p style="font-size: x-small;">CROP: _____</p> <p>_____</p> <p>_____</p> <p style="font-size: x-small;">CROP: _____</p> <p>_____</p> <p>_____</p> <p style="font-size: x-small;">CROP: _____</p> <p>_____</p> <p>_____</p> <p style="font-size: x-small;">CROP: _____</p> <p>_____</p> <p>_____</p> <p style="font-size: x-small;">WARRANTY STATEMENT</p> <p>_____</p> <p>_____</p>
--	--	--

PARTS OF THE LABEL

Brand Name

Each company has brand names for its products. The brand name is the one used in ads. The brand name shows up plainly on the front panel of the label. It is the most identifiable name for the product.

Type of Formulation

Different types of pesticide formulations (such as liquids, wettable powders and dusts) require different methods of handling. The label will tell you what type of formulation the package contains. The same pesticide may be available in more than one formulation.

Common Name

Many pesticides have complex chemical names. Some have been given another name to make them easier to identify. These are called *common names*. For instance, carbaryl is the common name for 1-naphthyl N-methylcarbamate. A chemical made by more than one company will be sold under several *brand names*, but you may find the same *common name* or chemical name on all of them.

Ingredient Statement

Every pesticide label must list what is in the product. The list is written so that you can see quickly what the active ingredients are. The amount of each *active ingredient* is given as a percentage by weight or as pounds per gallon of concentrate. It can be listed by either the chemical name or the common and chemical name. The *inert ingredients* need not be named, but the label must show what percent of the contents they make up.

Net Contents

The net contents number tells you how much is in the container. This can be expressed in gallons, pints, pounds, quarts, or other units of measure.

Name and Address of Manufacturer

The law requires the maker or distributor of a product to put the name and address of the company on the label. This is so you will know who made or sold the product and where he may be contacted.

Registration and Establishment Numbers

A registration number must be on every pesticide label. It shows that the product has been

registered with the federal government. It is found on the front panel of the label and will be written as "EPA Registration No. 0000." The establishment number tells what factory made the chemical. This number will be somewhere on each container, usually under the registration number.

Signal Words and Symbols

To do their job, most pesticides must control the target pest. By their nature, they are toxic. Therefore, some may be hazardous to people. You can tell the toxicity of a product by reading the *signal word* and looking at the *symbol* on the label.

Signal words: One of the most important parts of the label is the *signal word*. It tells you approximately how toxic the material is to people. The signal words that follow are set by law. Each manufacturer must use the correct one on every label:

<i>Signal Words</i>	<i>Toxicity</i>	<i>Approx. Amount Needed to Kill the Average Person</i>
DANGER	Highly toxic	a taste to a teaspoonful
WARNING	Moderately toxic	a teaspoon to a tablespoon
CAUTION	Low toxicity or comparatively free from danger	an ounce to more than a pint

All products must bear the statement "Keep out of reach of children."

Symbols: One of the best ways to catch a person's eye is with symbols. This is why a skull and crossbones is used on all highly toxic materials along with the signal word *DANGER* and the word *POISON*.

Pay attention to the symbol on the label. It is there to remind you that the contents could make you sick, or even kill you.

Precautionary Statement

Hazards to humans (and domestic animals): This section will tell you the ways in which the product may be poisonous to man and animals. It also will tell you of any special steps you should take to avoid poisoning, such as the kind of protective equipment needed.

If the product is highly toxic, this section will inform physicians of the proper treatment for poisoning.

Environmental hazards: Pesticides are useful tools. But wrong or careless use can cause undesirable effects. To help avoid this, the label contains environmental precautions that you should read and follow.

Here are some examples:

- "This product is highly toxic to bees exposed to direct treatment or to residues on crops."
- "Do not contaminate water when cleaning equipment or when disposing of wastes."
- "Do not apply where runoff is likely to occur."

Labels may contain broader warnings against harming birds, fish and wildlife.

Physical and chemical hazards: This section will tell you of any special fire, explosion or chemical hazards that the product may pose.

Statement of Practical Treatment

If swallowing or inhaling the product or getting it in your eyes or on your skin would be harmful, the label will tell you emergency first aid measures. It also will tell you what types of exposure require medical attention.

The pesticide label is the most important information you can take to the physician when you think someone has been poisoned.

Statement of Use Classification

Every pesticide label must show whether the contents are for general use or restricted use. EPA puts every product use into one of these two classes. The classification is based on: (a) the hazard of poisoning, (b) the way the pesticide is used, and (c) its effect on the environment.

General use: If a pesticide will harm the applicator or the environment very little or not at all when used exactly as directed, it will be labeled a general use pesticide.

The label on these products will say: "General classification."

Restricted use: A restricted use pesticide is one which could cause some human injury or environmental damage even when used as directed on the label. The label on these products will say: "Restricted use pesticide for retail sale to and application only by certified applicators or persons under their direct supervision."

The restricted use statement must be at the top of the front panel of the label.

Directions for Use

The instructions on how to use the pesticide are an important part of the label for you. This is the best way you can find out the right way to apply the product.

The use instructions will tell you:

- the pests the product is registered to control (labels use common names for pests; knowing these names will help you choose the proper pesticide and find control information),
- the crops, animals or other items the product can be used on,
- whether the product is for general or restricted use,
- in what form the product should be applied,
- how much to use,
- where the material should be applied,
- when it should be applied,
- how frequently the product can be applied,
- how soon the crop or animal may be marketed after the product is applied, and
- in many cases, how the product is to be applied.

Misuse statement: This section will remind you that it is a violation of federal law to use a product in a manner inconsistent with its labeling. Do not use a product on a crop or for a pest not listed on the label. Do not use it at more than the recommended rate. Before the product could be registered, EPA required the manufacturer to conduct many tests to be sure the label directions were correct. By following them exactly, you will: (a) get the best results the product can give, and (b) avoid breaking the law.

Re-entry statement: If required for the product, this section will tell you how much time must pass before a pesticide-treated area is safe for entry by a person without protective clothing. Consult local authorities for special rules that may apply.

Category of applicator: If required for the product, this section will limit use to certain categories of commercial applicators.

Storage and disposal directions: Every pesticide should be stored and disposed of correctly. This section will tell you how to store and dispose of the product and empty containers.

Self-Help Questions on Section 5 – Labels and Labeling

Now that you have studied the section, answer these questions. Write the answers with pencil without referring back to the text. When you are satisfied with your written answers, see if they are correct by checking them in the text. Erase your answer and write in the correct answer if your first answer is wrong.

1. *Does labeling include brochures, fliers, and other information handed out by your dealer about the pesticide?*
2. *What is a pesticide label?*
3. *What is meant by a brand name of pesticide?*
4. *Why is a common name often used in place of the chemical name of a pesticide?*
5. *In what ways can the amount of active ingredient in a formulation be given on the label?*
6. *What kinds of names can be used on the label to identify the active ingredients in a formulation?*
7. *Do the inert ingredients in a formulation have to be named on the label?*
8. *What signal words are placed on a label to identify a highly toxic pesticide? a moderately toxic pesticide? a pesticide of low toxicity?*
9. *Does the statement "Keep out of the reach of children" have to appear on the label of a pesticide of low toxicity?*
10. *Does the skull and crossbones symbol have to appear on the label of a pesticide of low toxicity?*
11. *What three types of hazards are noted in the precautionary statement on the label?*
12. *Why should you take the pesticide label to the physician when you think someone has been poisoned by that pesticide?*
13. *What are the bases for classifying a pesticide as "general use" or "restricted use"?*
14. *May a "general use" pesticide be purchased by someone who is not a certified applicator?*
15. *Do the directions for use on the label of a pesticide give (detailed or general) instructions on how to use that pesticide?*
16. *Is it against the law to use a pesticide in a manner not listed on the label?*
17. *What is meant by a re-entry statement?*
18. *Can sales of certain pesticides be limited to only commercial applicators?*
19. *Where can you find directions on the proper storage and disposal of an insecticide?*

SECTION 6: Protecting Man – Using Pesticides Safely

There are two good reasons for using pesticides safely:

1. to keep yourself and other people from being poisoned, and
2. to avoid harming the environment.

HOW PESTICIDES HARM MAN

Pesticides can cause injury. They are *toxic*. Manufacturers find out how toxic a pesticide is by testing it on animals. The product's *hazard* — the danger that injury will occur to man — depends on the toxicity of the active ingredient plus the exposure to the product during use.

Most pesticides can cause severe illness, or even death, if misused. But every registered pesticide can be used safely if you use proper care.

Children under 10 are the victims of at least half of the accidental pesticide deaths in this country. If pesticides were always cared for correctly, children would never touch them.

Many accidental pesticide deaths are caused by eating or drinking the product. But some mixers, loaders and applicators die or are injured when they breathe a pesticide vapor or get a pesticide on their skin. Repeated exposure to small amounts of some pesticides can cause sudden severe illness.

Most pesticides can enter the body through the skin. You may get more into your body this way than you would accidentally swallow or inhale while working. With some pesticides, skin contact alone can cause death.

You should be able to prevent *all* accidents with pesticides:

1. by using and storing pesticides away from children and other untrained persons, and
2. by taking care to follow directions when using them.

Products for restricted use need special care. The label is your guide.

SYMPTOMS OF PESTICIDE POISONING

You should know what kinds of sickness are caused by the pesticides you use. You should also know the conditions under which each one may make you sick.

There are two kinds of clues to pesticide poisoning. Some are feelings that only the person who has been poisoned can notice — such as nausea or

headache. These are *symptoms*. Others, like vomiting, also can be noticed by someone else. These are *signs*. So you should know:

- what your own feelings might mean, and
- what signs of poisoning to look for in your co-workers and others who may have been exposed.

All pesticides in the same chemical group cause the same kind of sickness. This sickness may be mild or severe, depending on the pesticide and the amount absorbed. But the *pattern* of illness caused by one type of pesticide is always the same. Having some of the signs and symptoms does not always mean you have been poisoned. Other kinds of sickness may cause similar signs and symptoms. Headache and a feeling of being unwell, for example, may signal the start of many kinds of illness. It is the *pattern of symptoms* that makes it possible to tell one kind of sickness from another.

Get medical advice quickly if you or any of your fellow workers have unusual or unexplained symptoms starting at work or later the same day. If you suspect a person has been poisoned, do not leave him alone. Do not let yourself or anyone else get dangerously sick before calling your physician or going to a hospital. It is better to be too cautious than too late. Take the container (or the label) of the pesticide to the physician. Do not carry the pesticide container in the passenger space of a car or truck.

SYNTHETIC ORGANIC PESTICIDES

Organophosphates

These pesticides injure the nervous system. The signs and symptoms go through stages. They normally occur in the following order:

Mild poisoning:

- fatigue
- headache
- dizziness
- blurred vision
- excessive sweating and salivation
- nausea and vomiting
- stomach cramps or diarrhea

Moderate poisoning:

- unable to walk
- weakness
- chest discomfort
- muscle twitches
- constriction of pupil of the eye
- earlier symptoms become more severe

Severe poisoning:

- unconsciousness
- severe constriction of pupil of eye
- muscle twitches
- secretions from mouth and nose
- breathing difficulty
- death if not treated

Illness may be delayed a few hours, but if signs or symptoms start more than 12 hours after you were exposed to the pesticide, you probably have some other illness. Check with your physician to be sure.

Carbamates

The only carbamates likely to make you ill on the job act almost like organophosphates. They produce the same signs and symptoms if you are poisoned by them. But the injury they cause can be corrected more easily by a physician. For this reason, most carbamates are safer than organophosphates. The label will warn you of the danger.

Organochlorines

Not many organochlorines (chlorinated hydrocarbons) have poisoned applicators. Early signs and symptoms of poisoning include:

- headache,
- nausea,
- vomiting,
- general discomfort, and
- dizziness.

With more severe poisoning, convulsions follow. They may even appear without the warning symptoms. Coma may follow the convulsions. The person also may be unusually excited or irritable.

Nitrophenols and Pentachlorophenol

The signs and symptoms of skin exposure include:

- redness,
- burning, and
- blisters.

The signs and symptoms of poisoning include:

- headache,
- nausea,
- gastric distress,
- restlessness,
- hot feeling,
- flushed skin,
- sweating,
- deep and fast breathing,
- fast beating of the heart,
- fever,
- ashen color,
- collapse, and
- coma.

Severe poisoning usually runs a rapid course. One usually dies or is almost well within 24 to 48 hours.

Fumigants and Solvents

Too much exposure to these compounds may make a person seem drunk. The signs and symptoms are:

- poor coordination,
- slurring words,
- confusion, and
- sleepiness.

Repeated exposure to the fumigant methyl bromide has caused permanent internal injury without early signs or symptoms of poisoning. You can absorb a fatal dose of it before symptoms appear.

INORGANIC PESTICIDES

Large single doses of most inorganic pesticides cause vomiting and stomach pain. The signs and symptoms depend on the mineral from which the pesticide is made.

PLANT-DERIVED PESTICIDES

Some plant-derived pesticides are very toxic. Technical pyrethrum may cause allergic reactions. Some rotenone dusts irritate the respiratory tract. Nicotine is a fast-acting nerve poison about as dangerous as parathion. Some other plant-derived pesticides are strychnine and red squill.

FIRST AID PROCEDURES

Read the directions in the "Statement of Practical Treatment" on each label. These instructions could save your life or the lives of your employees.

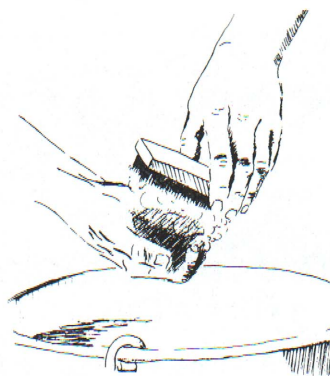

If You Get a Pesticide on Your Skin

Remove the pesticide as quickly as possible. Remove all contaminated clothing. Prompt washing may prevent sickness even when the spill is

very large. Don't forget your hair and fingernails. Water-wettable powders or suspensions are easy to remove with plain water. So are most emulsifiable concentrates and emulsions. Solutions of pesticides in petroleum oil or other solvents are harder to remove without soap or a detergent. Detergents work better. Washrooms and emergency field washing facilities should have detergents rather than plain soap.

If You Get Pesticides into Your Eyes

Flush your eyes and face thoroughly with water.

If You Inhale a Pesticide

Get to fresh air right away.

If You Splash a Pesticide into Your Mouth or Swallow It

Rinse your mouth with plenty of water, go or be taken to a physician immediately. It is sometimes dangerous to cause vomiting; follow label directions.

POISON TREATMENT CENTERS

In case of emergencies, the following list of poison treatment centers in Michigan will help you contact the nearest source of help that specializes in treatments of poisoning.

ADRIAN	Poison Control Center Emma L. Bixby Hospital 818 Riverside Ave. 49221	(517) 263-2412	HOLLAND	Poison Control Center Holland City Hospital 602 Michigan Ave. 49423	(616) 396-4661
ANN ARBOR	Poison Control Center University of Michigan Medical Center 1405 E. Ann St. 48109	(313) 764-5102	JACKSON	Poison Control Center W. A. Foote Memorial Hospital 205 N. East Ave. 49201	(517) 783-2771
BATTLE CREEK	Poison Control Center Community Hospital 183 West 49016	(616) 963-5521	KALAMAZOO	Poison Control Center Borgess Hospital 1521 Gull Rd. 49001	(616) 383-4815
BAY CITY	Poison Control Center Bay Medical Center 100 15th St. 48706	(517) 892-6589		Poison Control Center Bronson Methodist Hospital 252 E. Lovell St. 49006	(616) 383-6409
BERRIEN CENTER	Poison Control Center Berrien General Hospital 1250 Dean's Hill Rd. 49102	(616) 471-7761	LANSING	Poison Control Center St. Lawrence Hospital 1210 W. Saginaw St. 48914	(517) 372-5112
COLDWATER	Poison Control Center Community Health Center of Branch County 274 E. Chicago St. 49036	(517) 278-7361	MARQUETTE	Poison Control Center Marquette General Hospital 420 W. Magnetic St. 49855	(906) 228-9440
DETROIT	Poison Control Center Children's Hospital of Michigan 3901 Beaubien Blvd. 48201	(313) 494-5711	MIDLAND	Poison Control Center Midland Hospital 4005 Orchard Dr. 48640	(517) 631-7700
	Poison Control Center Mount Carmel Mercy Hospital 6071 W. Outer Dr. 48235	(313) 864-5536	MONROE	Poison Control Center Mercy-Memorial Hospital 700 Stewart Rd. 48161	(313) 241-6509
ELOISE	Poison Control Center Wayne County General Hospital 30712 Michigan Ave. 48132	(313) 722-3748	PETOSKEY	Poison Control Center Little Traverse Hospital 415 Connable Ave. 49770	(616) 347-7373
GRAND RAPIDS	West Michigan Poison Center Blodgett Memorial Medical Center 1840 Wealthy, S.E. 49506	(800) 442-4571 (within 616 area code) (800) 632-2727 (rest of state)	PONTIAC	Poison Control Center St. Joseph Mercy Hospital 900 Woodward Ave. 48053	(313) 858-3000
	Poison Control Center St. Mary's Hospital 200 Jefferson, S.E. 49502	(616) 774-6794	PORT HURON	Poison Control Center Mercy Hospital 2601 Electric Ave. 48060	(313) 985-9531
HANCOCK	Poison Control Center St. Joseph's Hospital 200 Michigan Ave. 49930	(906) 482-1122		Poison Control Center Port Huron Hospital 1001 Kearney St. 48060	(313) 987-5555
			SAGINAW	Poison Control Center Saginaw General Hospital 1447 N. Harrison Rd. 48602	(517) 755-1111
			TRAVERSE CITY	Poison Control Center Munson Medical Center Sixth and Madison 49684	(616) 941-1131

PROTECTING YOUR BODY

Pesticides can enter the body in many ways. The main ones are:

1. getting the pesticide on your skin,
2. inhaling it, and
3. swallowing it.

To prevent this, you must wear protective clothing and equipment. No safety recommendations can cover all situations. Your common sense should tell you to use more protection as the hazard increases. The pesticide label will tell you the kind of protection you need.

Remember to bathe, using a detergent, when you finish working with pesticides or pesticide-contaminated equipment. Any time you spill a pesticide on yourself, wash immediately and put on clean clothes.

Protective Clothing

Body covering: Any time you handle pesticides, you should wear at least:

- a long-sleeved shirt and long-legged trousers, or
- a coverall type garment.

They should be made of tightly woven fabric. When handling pesticide concentrates or very toxic materials, you also should wear a liquid-proof raincoat or apron. Wear trousers *outside* of the boots to keep pesticides from getting inside.



Gloves: When you handle concentrated or highly toxic pesticides, wear liquid-proof neoprene gloves. However, some fumigants are readily absorbed by neoprene. The label will tell you what kind of gloves to use. They should be long enough to protect the wrist. Gloves should not be lined with a fabric. The lining is hard to clean if a chemical gets on it. Sleeves should be *outside* of the gloves to keep pesticides from running down the sleeves into the gloves.

Hat: Wear something to protect your head. A wide-brimmed, waterproof hat will protect your head, neck, eyes, mouth and face. It should not

have a cloth or leather sweatband. These sweatbands are hard to clean if chemicals get on them. Plastic "hard hats" with plastic sweatbands are good. They are waterproof and are cool in hot weather.

Boots: Wear unlined neoprene boots. However, some fumigants are readily absorbed by neoprene boots. Follow label instructions.

Goggles or face shield: Wear goggles or a face shield when there is any chance of getting pesticides in your eyes. Your eyes will absorb many pesticides. You can wear goggles alone or with a respirator.

Care of clothing. Wear clean clothing daily. If clothes get wet with spray, change them right away. If they get wet with pesticide concentrates or highly toxic pesticides, destroy them. They are hard to get clean by normal methods. Do not store or wash contaminated clothing with the family laundry. Wash hats, gloves, and boots daily, inside and out. Hang them to dry. Test gloves for leaks by filling them with water and gently squeezing.

Respiratory Protective Devices

The respiratory tract — the lungs and other parts of the breathing system — is much more absorbent than the skin. You *must* wear an approved respiratory device when the label directs you to do so. Follow the label instructions on respiratory protection.

You probably will need a respirator:

1. if you will be exposed to a pesticide for a long time,
2. if the pesticide you are using is highly toxic, or
3. if you are working in an enclosed area.



Chemical cartridge respirator: You should wear this kind of respirator when you are exposed to intermittent concentrations of a toxic pesticide.

The inhaled air comes through both a filter pad and a cartridge made to absorb pesticide vapors. Most harmful vapors, gases and particles are removed. These half-face masks cover the mouth and nose. To cover the eyes also, use one that is combined with goggles or wear separate goggles.



Chemical canister respirator (gas mask): You should wear this kind of respirator when you are exposed to a continuous concentration of a toxic pesticide.

The canister has longer-lasting absorbing material and filters than a cartridge respirator. Gas masks usually protect the face better than cartridge

types. However, neither kind will protect you during fumigation or when the oxygen supply is low, as in a silo.

Selection and maintenance. Specific types of cartridges and canisters protect against specific chemical gases and vapors. Be sure you choose one made for the pesticides you are using. Use only those approved by the National Institute for Occupational Safety and Health (NIOSH), or the Mining Enforcement and Safety Administration (MESA).

The respirator must fit the face well. Long sideburns, a beard or glasses may prevent a good seal. Read the manufacturer's instructions on the use and care of any respirator and its parts before you use it.

When applying pesticides, change filters, cartridges and canisters if you have trouble breathing, or if you smell pesticides. Remove and discard filters, cartridges and canisters after use. Then wash the face piece with detergent and water, rinse it and dry it with a clean cloth. Store in a clean, dry place away from pesticides.

The useful life of a cartridge or canister depends on:

- the amount of absorbent material,
- the concentration of contaminants in the air,
- the breathing rate of the wearer, and
- the temperature and humidity.

If you have trouble breathing while wearing a respiratory device, see your physician to find out whether you have a respiratory problem.

Self-Help Questions on Section 6 – Using Pesticides Safely

Now that you have studied the section, answer these questions. Write the answers with pencil without referring back to the text. When you are satisfied with your written answers, see if you are correct by checking them in the text. Erase your answer and write in the correct answer if your first answer is wrong.

1. What does the word hazard mean with respect to pesticides?
2. What percentage of poison victims are children under 10 years of age?
3. Can you become injured from pesticides that are spilled on your skin?
4. Where can you find a guide for the safe use of a pesticide?

5. *How does a symptom of poisoning differ from a sign of poisoning?*
6. *What should you do if you or someone else have unusual symptoms soon after working with pesticides?*
7. *Should a person with symptoms of poisoning be left alone at any time?*
8. *What should be taken to the physician along with the person who has poison symptoms?*
9. *What are the signs and symptoms of mild poisoning by organophosphate pesticides?*
10. *How long after exposure to the insecticide will signs and symptoms appear?*
11. *Are cases of poisoning by carbamate pesticides harder or easier to treat than cases of organophosphate poisoning?*
12. *Are convulsions from poisoning with organochlorine pesticide always preceded by earlier signs and symptoms?*
13. *What are signs and symptoms of skin exposure to nitrophenol and pentachlorophenol?*
14. *Can repeated exposure to methyl bromide be fatal?*
15. *What are signs and symptoms of a large dosage of most inorganic pesticides?*
16. *What plant-derived pesticide is about as toxic as the highly toxic parathion?*
17. *Where can you obtain directions for first aid procedures for an insecticide?*
18. *Is detergent or soap recommended for washing pesticides off the skin?*
19. *What should you do if you inhale (breathe in) a pesticide?*
20. *Should vomiting be induced in all cases where pesticides are swallowed?*
21. *How soon after applying a pesticide should you bathe?*
22. *Should you have your pant legs inside or outside of your boots while handling pesticides?*
23. *Should cloth-lined gloves be used for handling pesticides?*
24. *Why is a plastic "hard hat" a good hat to use when handling pesticides?*

25. *What kind of boots are recommended for use while handling most pesticides?*
26. *When should goggles or face shield be worn while handling a pesticide?*
27. *How often should you change to clean clothes when using pesticides?*
28. *Where can you find directions on the need to use a respirator and the type of respirator to use while working with a pesticide?*
29. *Do you need to use a chemical cartridge respirator while working with pesticides of low or moderate toxicity?*
30. *Why is a chemical canister respirator (gas mask) better than a chemical cartridge respirator for prolonged exposure to a pesticide?*
31. *When should you change the filters, cartridges or canisters of a respirator?*

SECTION 7: Protecting the Environment

The “environment” is our surroundings and its many forms of life. Every plant or animal is affected by other plants or animals in the environment. Factors like rain, temperature and wind are part of the environment. We cannot do much about them. But we can control some other things, including the use of pesticides.

Many people consider pesticides a tool for preserving or improving the environment. Others feel that they cause pollution. As a weed is a “plant out of place,” a pesticide sometimes can be a “tool out of place.” Correct use prevents pollution by pesticides.

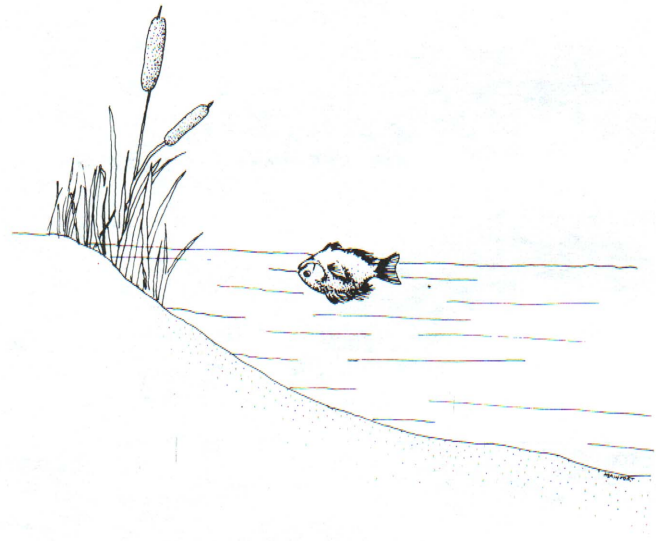

HOW PESTICIDES HARM THE ENVIRONMENT

Using pesticides in a way other than as directed on the label can:

- injure plants and animals,
- leave illegal residues, and
- damage the environment in many other ways.

Any pesticide can cause harm if not chosen and used with care. Here are some ways damage can occur.

Direct Kill of Nontarget Organisms

Do not let a pesticide contact anything except the target area. Drift from herbicides can kill nearby crops and landscape plants. You may kill bees and other pollinators if you treat a crop while they are working in a field. Or you could kill parasites and predators that help control harmful insects.

Pesticides are sometimes applied over a large area. Targets are such things as mosquitoes, forest insects and weeds. Many nontarget plants and animals within the treated area may be harmed. Plan area projects with great care so you will not do irreparable damage to the environment.

Runoff from a sprayed field can kill fish in a nearby stream or pond. Life in streams can be wiped out by careless tank filling or draining and improper container disposal.

All of these kills can result in lawsuits, fines, and/or loss of certification.

If more than one pesticide will control your target pest, choose the one that is the least hazardous to the environment and most useful for your situation. Ask your county Extension agricultural agent to help you make this choice.

Persistence and Accumulation

Not all pesticides act the same after you apply them. Most are in one of these two groups:

Pesticides that break down quickly: These remain on the target or in the environment only a short time before being changed into harmless products. Some are highly toxic. Others are fairly harmless.

Pesticides that break down slowly: These may stay in the environment without change for a long time. Often this is good, because you get long-term control. These are called *persistent pesticides*. Most of them are: (a) not broken down easily by microorganisms, and (b) only slightly soluble in water.

Some persistent pesticides can injure sensitive crops planted on the same soil the next year. But they seem to be of little hazard to the environment beyond the treated soil. Other persistent pesticides can build up in the bodies of animals, including man. They may build up until they are harmful to the animal itself or to the meat eater that feeds on it. These are called *accumulative pesticides*.

Pesticide Movement in the Environment

Pesticides become problems when they move off target. This may mean:

- drifting out of the target area,
- moving on soil through runoff or erosion,
- leaching through the soil,
- being carried out as residues in crops and livestock, or
- evaporating and moving with air currents.

PESTICIDES AND BEES

Michigan's bees produce 8 to 10 million pounds of honey a year, worth about \$1.5 million. The total value of commercial and "backyard" crops pollinated by bees in Michigan is about \$100 million.

Pesticide damage to bees takes many forms. Colonies may be completely destroyed, but most commonly, only field bees are killed. Loss of field bees can be serious because the factor contributing most to a beekeeper's success in honey production or pollination is his ability to build up colonies that are strong in numbers of bees. If the field force is destroyed by pesticides, the whole colony will be weakened and may remain weak for some time.

The present challenge is to determine how and when to use pesticides, and which pesticides and supplementary control measures to use, so that pests may be most adequately controlled without killing bees.

Following is a brief interpretation of precautions necessary to avoid killing bees:

1. **Do not apply insecticides to crops in bloom.** Don't allow spray to drift to plants in bloom. Drift to nontarget plants accounts for most bee-kill.
2. **Timing the application of insecticides.** Ideally, pesticides should be applied when there is no wind and bees are not "working" plants in the area. Little damage will result if the crop is sprayed late in the afternoon with a spray that breaks down in a few hours. In general, evening applications are least harmful to bees.
3. **Variable toxicity of insecticides.** Nearly all agricultural pesticides have been laboratory tested and rated for their toxicity to bees. Where there is a choice of pesticides, use those least toxic to bees. In general, granular applications are not harmful to bees.
4. **Puddles of spray and spray in the water supply.** Bees gather water to drink and to regulate temperature and humidity within the hive. Care should be taken not to let spray drip and form puddles, accumulate in wheel tracks or to be exposed in any way.

5. **Air vs. ground application.** Air application of insecticides is more dangerous to bees than ground application, chiefly because the material drifts greater distances and is applied much more rapidly. Application of insecticides to large areas may be harmful because bees cannot avoid contact with the spray on flowers or in water. Total wild bee and honey bee loss over the large area may be sizable.
6. **Formulation of the material.** Sprays are usually less harmful than dusts because they do not drift as much. Granular materials seem to present very little hazard. Ultra-low-volume applications of some materials have been more toxic than regular sprays. No effective repellent has yet been developed that may be added to the spray to keep bees from treated areas.
7. **Follow official spray recommendations.**

It is not easy to move colonies of honey bees from an established apiary. Beekeepers should not be expected to move colonies and suffer honey production loss unless there is no alternative.

SOILS AND PESTICIDES

Persistent pesticides may limit future planting. You can plant only crops the pesticide will not kill or contaminate.

Even pesticides directed at plants or animals can move to the soil. They may be washed or brushed off. They may be worked into the soil with dead plant parts.

AIR AND PESTICIDES

Pesticides in the air cannot be controlled. They can settle into water, crops, trees, houses, or barnyards. The wind can carry them hundreds of miles — even gentle breezes can carry them away from the target.

WATER AND PESTICIDES

Water is necessary for all life. But it is not safe to drink or bathe in polluted water.

Most fish and other aquatic life can survive only slight changes in their environment. Even tiny amounts of many pesticides can harm them or destroy the food they live on. They may die at once, or there may be chronic effects. The behavior of an animal can be changed so that predators can more easily catch and kill it. Pesticide-contaminated eggs may not hatch.

Pesticides in water also may harm other wildlife. Polluted irrigation water can harm crops, soil and livestock. It can cause illegal residues in crops, milk, and meat.

Pesticides contaminate water in many ways. They are applied directly to water when controlling some pests. This can be done safely if you:

- choose the pesticides carefully,
- make sure they are registered for the use intended, and
- apply them when and as directed.

But water can be polluted if you use the wrong pesticide or apply it carelessly.

Pesticides also can reach water directly as a result of:

- drifts,
- spills,

- application to waterways (ditches and streams), and
- incorrect disposal methods.

BENEFITS OF CAREFUL USE

Pesticides help the environment when they are used correctly. Most importantly, they can help produce better quality and higher yields of food, fiber and timber by reducing damage from pests.

Weigh carefully the advantages and disadvantages of each pesticide application. Choose the pesticide that will do the least damage while giving good control. Finally, plan each part of the job carefully from beginning to end.

Be a responsible pesticide applicator.

Self-Help Questions on Section 7 – Protecting the Environment

Now that you have studied the section, answer these questions. Write the answers with pencil without referring back to the text. When you are satisfied with your written answers, see if you are correct by checking them in the text. Erase your answer and write in the correct answer if your first answer is wrong.

1. *What is meant by the word environment?*
2. *Name some nontarget organisms that can be killed by poorly selected or poorly used pesticides.*
3. *What is a control advantage of a persistent pesticide?*
4. *What is a problem caused by an accumulative pesticide?*
5. *How can soil pesticides cause problems to the environment?*
6. *How does air movement affect pesticides in the environment?*
7. *Do you need a permit to apply pesticides to water?*
8. *Other than by direct application, how else do pesticides enter water?*
9. *What is the most important benefit from the careful use of pesticides?*

SECTION 8: Safe Use Precautions

Most parts of your job may involve some risk of pesticide injury. Injury can occur when you are:

- hauling pesticides,
- storage,
- mixing,
- calibrating equipment before use,
- loading,
- applying,
- repairing equipment,
- working in pesticide-treated crops and buildings,
- cleaning application equipment after use,
- disposing of surplus pesticides and empty containers,
- cleaning up spills, and
- cleaning protective clothing and equipment.

Some of these things are done indoors. Many are done outdoors. Each one requires some safety measures to prevent harm to people, animals, and plants as well as to soil and water outside the target area.

You can prevent harm from pesticides if you follow safety precautions and use common sense. Here are the *minimum* safety steps you should take.

BEFORE YOU BUY A PESTICIDE

The first and most important step in choosing a pesticide is to know what pest you need to control. Then find out which pesticides will control it. You may have a choice of several. You may need help to guide you. Common sources of information are your Cooperative Extension Service, most agricultural schools, the U.S. Department of Agriculture, and pesticide manufacturers and dealers.

AT THE TIME OF PURCHASE

Read the label of the pesticide you intend to buy to find out:

- restrictions on use,
- if this is the correct chemical for your problem,
- if the product can be used safely under your conditions,
- environmental precautions needed,
- if the formulation and amount of active ingredient are right for your job,
- if you have the right equipment to apply the pesticide,
- if you have the right protective clothing, and
- how much pesticide you need.



BEFORE YOU APPLY THE PESTICIDE

Read the label again to find out:

- the protective equipment needed to handle the pesticide,
- the specific warnings and first aid measures,
- what it can be mixed with,
- how to mix it,
- how much to use,
- safety measures,
- when to apply to control the pest and to meet residue tolerances,
- how to apply,
- the rate of application, and
- special instructions.

TRANSPORTATION OF PESTICIDES

You are responsible for the safe transport of your pesticide.

1. The safest way to carry pesticides is in the back of a truck.
2. Fasten down all containers to prevent breakage and spillage.
3. Keep pesticides away from food, feed, and passengers.
4. Pesticides should be in a correctly labeled package.
5. Keep paper and cardboard packages dry.
6. If any pesticide is spilled in or from the vehicle, clean it up right away. Use correct cleanup procedures.
7. Do not leave unlocked pesticides unattended. You are responsible if accidents occur.

PESTICIDE STORAGE

The label will tell you how to store the product.

As soon as pesticides arrive, correctly store them in a locked and posted place. Children and other untrained persons should not be able to get to them.

The storage place should keep the pesticides dry, cool and out of direct sunlight. It should have enough insulation to keep the chemicals from freezing or overheating.

The storage place should have:

- fire-resistant construction, including a cement floor,
- an exhaust fan for ventilation,
- good lighting, and
- a lock on the door.

Keep the door locked when the building is not in use.

The store building should be away from where people and animals live. This will avoid or minimize harm to them in case of fire.

Store all pesticides in the original containers.

Do not store them near food, feed, seed, or animals.

Check every container often for leaks or breaks. If one is damaged, transfer the contents to a container that has held *exactly* the same pesticide. Clean up any spills correctly.

Keep an up-to-date inventory of the pesticide you have.

MIXING AND LOADING PESTICIDES



Before handling a pesticide container, put on the correct protective clothing and equipment.

Keep livestock, pets, and people out of the mixing and loading area.

Do not work alone, especially at night.

Work outdoors. Choose a place with good light and ventilation. Do not mix or load pesticides indoors or at night unless there is good lighting and ventilation.

Each time you use a pesticide, read the directions for mixing. Do this before you open the container. *This is essential.* Directions, including amounts and methods, are often changed.

Do not tear paper containers to open them. Use a sharp knife. Clean the knife afterwards, and do not use it for other purposes.

When taking a pesticide out of the container, keep the container and pesticide below eye level. This will avoid a splash or spill on your goggles or protective clothing. Do the same thing when pouring or dumping any pesticide.

If you splash or spill a pesticide while mixing or loading:

1. Stop right away.
2. Remove contaminated clothing.
3. Wash thoroughly with detergent and water. *Speed is essential.*
4. Clean up the spill.

When mixing pesticides, measure carefully. Use only the amount called for on the label. Mix only the amount you plan to use.

When loading pesticides, stand so the wind blows across your body from the right or left to avoid contaminating yourself.

To prevent spills, replace all pour caps and close containers immediately after use.

PESTICIDE APPLICATION

Wear the correct protective clothing and equipment.

To prevent spillage of chemicals, check all application equipment prior to adding the pesticide for: (a) leaking hoses, pumps or connections, and (b) plugged, worn, or dripping nozzles.

Use water to correctly calibrate spray equipment before use. Before starting a field application, clear all livestock and people from the area to be treated.

Drift is the movement of spray droplets or dust particles away from the target area. Drift increases:

- as droplets or particle size decreases, and
- as wind speed increases.

It can be minimized if you:

- spray at low pressure,
- use the largest practical nozzle openings, and
- spray during the calmer parts of the day.

Vaporization is the evaporation of an active ingredient during or after application. Pesticide vapors can cause injury far from the site of applica-

tion. High temperatures increase vaporization. You can reduce vaporization by:

- choosing nonvolatile chemical formulations, and
- spraying in the cooler parts of the day.

CLEANING EQUIPMENT

Mixing, loading and application equipment must be cleaned as soon as you finish using it. Clean both the inside and outside, including nozzles. Only trained persons should do this job. They should wear proper protective clothing.

Sometimes you may need to steam clean equipment or use special cleaning agents. In other cases, hot water and detergent may be enough.

Have a special area for cleaning. It is best for the area to have a wash rack or concrete apron with a good sump. This will catch all contaminated wash water and pesticides. Dispose of sump wastes by burning or burial as you would excess pesticides. Keep drainage out of water supplies and streams.

Equipment sometimes must be repaired before it is completely cleaned. Warn the person doing the repairs of the possible hazards.

DISPOSAL

Excess Pesticides

EPA recommends ways to dispose of excess pesticides. Consult local authorities for procedures in your area. If you have excess organic pesticides:

- Use them up as directed on the label.
- Burn them in a specially designed pesticide incinerator.
- If you do not have access to proper facilities for burning, bury the pesticides in a specially designated landfill.
- If you cannot either burn or bury them right away, store the pesticides until you can.

These EPA recommendations also tell you how to dispose of excess diluted liquid pesticides. Add these and rinse liquids to spray mixture in the field when you can. If you cannot use excess diluted pesticides, follow the disposal instructions for excess pesticides.

Containers

To prepare containers for disposal:

1. Empty the containers into the tank. Let it drain an extra 30 seconds.
2. Fill it one-fifth to one-fourth full of water.
3. Replace the closure and rotate the container. Upend the container so the rinse reaches all the side surfaces.

4. Drain the rinse water from the container into the tank. Let the container drain for 30 seconds after emptying.
5. Repeat steps 2 through 4 at least two more times for a total of three rinses.

Remember to empty each rinse solution into the tank.

The EPA recommendations divide containers into three groups and tell you how to dispose of each kind.

Group I containers: These are containers which will burn, and which held inorganic or metallic pesticides, but not organic mercury, lead, cadmium, or arsenic compounds. Here are ways to dispose of them:

- You may burn them in special pesticide incinerators.
- You may bury them in a specially designated landfill.
- You may burn small numbers of them as directed by state and local regulations.
- You may bury them singly in open fields. Bury them at least 18 inches below the surface. Be careful not to pollute surface or subsurface water.

Group II containers: These are containers which will *not* burn, and which held inorganic or metal or organic pesticides, but not organic mercury, lead, cadmium, or arsenic compounds. Here are ways to dispose of them:

- Rinse the containers three times.
 - Many large containers in good shape can be reused by your supplier. Return them to the pesticide manufacturer or formulator, or drum reconditioner.
 - You can send or take them to a place that will recycle them as scrap metal or dispose of them for you.
 - All rinsed containers may be crushed and buried in a sanitary landfill. Follow state and local standards.
 - You may bury them in the field.
- If the containers have not been rinsed:
- Bury them in a specially designated landfill.

Group III containers: These include any containers which held organic mercury, lead, cadmium, or arsenic, or inorganic pesticides. Here are ways to dispose of them:

- Rinse them three times and bury them in a sanitary landfill.
- If they are not rinsed, bury them in a specially designated landfill.

CLEANUP OF PESTICIDE SPILLS



Minor Spills

Keep people away from spilled chemicals. Rope off the area and flag it to warn people. Do not leave unless someone is there to warn of the danger.

If the pesticide was spilled on anyone, give the correct first aid.

Confine the spill. If it starts to spread, dike it up with sand or soil.

Use an absorbent material to soak up the spill. You can use soil, sawdust, or a special product made to do this. Shovel all contaminated material into a leakproof container for disposal. Dispose of it as you would excess pesticides. Do not hose down the area. This spreads the chemical.

Put something on the spill to stop the chemical action. You may be able to use common household bleach or a solution of lye or ammonia. If you are not sure what to use, call the chemical manufacturer. Always work carefully. Do not hurry.

Do not let anyone enter the area until the spill is all cleaned up.

Major Spills

The cleanup job may be too big for you to handle. You may not be sure of what to do. In either case, keep people away, give first aid, and confine the spill. Then call the manufacturer for help.

The National Agricultural Chemicals Association has a Pesticide Safety Team Network. They can tell you what to do. Or they can send a safety team to clean up the spill. You can call them toll-free any time at (800) 424-9300.

If a major pesticide spill occurs on a highway, have someone call the state police or the sheriff for help. (Carry these phone numbers with you.) Do not leave until responsible help arrives.

Report all major spills by phone to the Department of Natural Resources; (517) 373-7660. You also may need to notify other authorities:

If the spill is on a state highway, call:

- the state police, or
- the state highway department.

If the spill is on a county road or a city street, call:

- the county sheriff, or
- city police.

If food is contaminated, notify:

- state or federal food and drug authorities, or
- city, county, or state health officials.

If water is contaminated, notify:

- state health officials,
- regional, state, or federal water quality or water pollution authorities, and
- the state department of natural resources.

SAFE-ENTRY TIMES

It may be dangerous for an unprotected person to enter an area immediately after some pesticides have been used. The time that must pass before the area is safe for a person without protective clothing is called a safe-entry time, or reentry period. This time is given on the label of each pesticide that may cause a reentry problem. It varies according to the pesticide applied and the crop or area treated. These times have been set to allow harmful pesticide residues to break down or disappear. Reentry may pose special problems in some areas. Check with local authorities for any special rules that may apply.

Self-Help Questions on Section 8 – Safe Use Precautions

Now that you have studied the section, answer these questions. Write the answers with pencil without referring back to the text. When you are satisfied with your written answers, see if you are correct by checking them in the text. Erase your answer and write in the correct answer if your first answer is wrong.

- 1. Where can you obtain information on selecting a pesticide for control of a pest?*
- 2. Should you read the label on a pesticide: (a) when you buy the pesticide? (b) before you use the pesticide? or (c) at both times?*
- 3. What kind of a vehicle is safest for transporting pesticides?*
- 4. Describe the features of a safe storage area for pesticides.*
- 5. Where should a pesticide be placed if the original container that it comes in is damaged?*
- 6. Should you work alone while mixing or loading pesticides?*
- 7. What should you do if you spill pesticides on yourself?*
- 8. How can drift of a pesticide be reduced?*
- 9. What does vaporization of a pesticide mean?*
- 10. Where should pesticide equipment be cleaned?*
- 11. How should you dispose of excess pesticides?*
- 12. How should you rinse out containers for disposal?*
- 13. Can small lots of Group I (burnable) containers be disposed of by burning if burning is approved by local regulations?*
- 14. Can Group II (unburnable) containers be rinsed and used for recycling as a means of disposal?*
- 15. Can Group III containers (those that had inorganic or organic mercury, lead, cadmium, or arsenic pesticides) be disposed by burying them in the field?*
- 16. Should the area where a pesticide has been spilled be hosed down with water?*
- 17. Who should be notified immediately if a large amount of pesticide is spilled on a road or street?*
- 18. What is meant by reentry period with regard to pesticides?*

SECTION 9: Application Equipment

The pesticide application equipment you use is important to the success of your pest control job. You must first select the right kind of application equipment. Then you must use it correctly according to your needs and take good care of it. These things are true whether you use hand-carried, tractor-drawn, or self-propelled equipment. Here are some things you should know about choosing, using and caring for equipment.

SPRAYERS

Your sprayer should be:

1. designed to do the job you want to do,
2. durable, and
3. convenient to fill, operate and clean.

Hand Sprayers

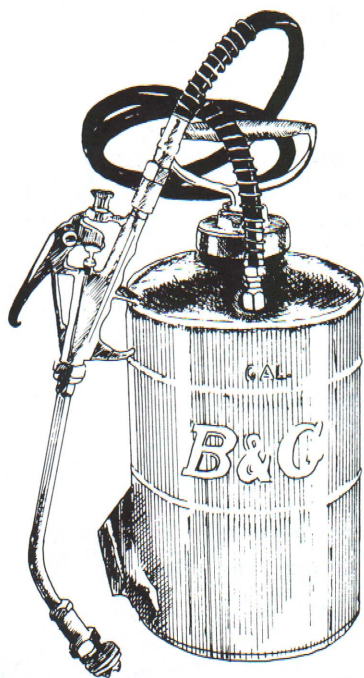

Hand sprayers are for application of pesticides in structures such as greenhouses and can be used for small jobs such as spot treatments. You can use them in restricted areas where a power unit would not work.

Advantages:

- economical,
- simple, and
- easy to use, clean and store.

Limitation:

- Frequent lack of good agitation and screening for wettable powders. Keep WP's in suspension by shaking the sprayer.

Low-Pressure Field Sprayers

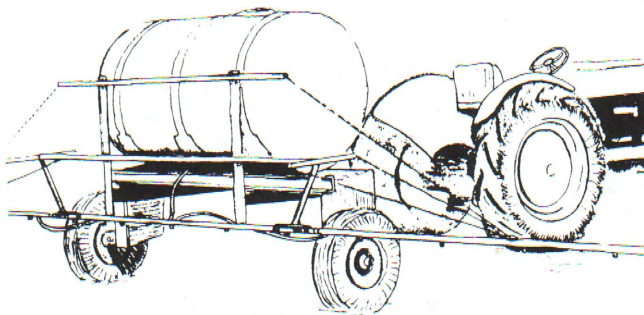

These sprayers are designed to deliver low to moderate volume at 15 to 50 psi. Most of them are used for treating field and forage crops, pastures, fence rows and structures. They also may be used to apply fertilizer-pesticide mixtures.

Advantages:

- medium to large tanks,
- low cost,
- light weight, and
- versatility.

Limitations:

- low gallonage output limits their use when high volumes are required,
- low pressure may limit pesticide penetration, and
- agitation is limited.

High-Pressure Sprayers

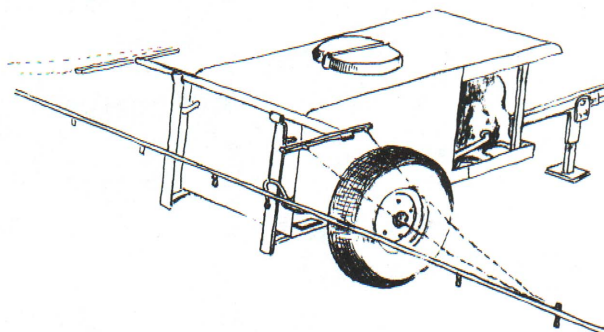

These are often called hydraulic sprayers. They are designed to deliver large volumes at high pressure. They are used to spray fruits, vegetables, trees, landscape plants, and livestock. When fitted with the correct pressure regulators, they can be used at low pressures. Applications usually are made at high gallonages (usually 50 or more per acre). Even though very large tanks are used, they may need to be filled often.

Advantages:

- good spray coverage and penetration,
- well built,
- usually have mechanical agitation, and
- last a long time even when using wettable powders.

Limitations:

- high cost,
- large amounts of water, power, and fuel needed,
- high tire loads, and
- high pressures which produce a spray that may drift easily.

Air Blast Sprayers

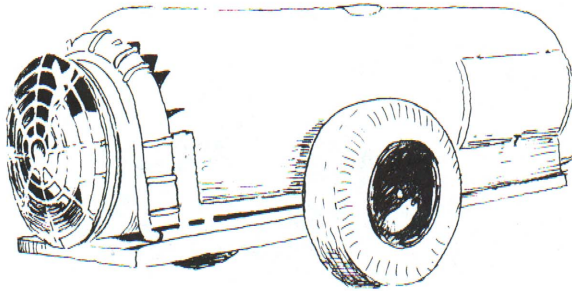

These units use a high-speed, fan-driven air stream to break the nozzle output into fine drops which move with the air stream to the target. The air is directed to either one or both sides as the sprayer moves forward. These sprayers are used in applying pesticides to landscape plants, fruits and vegetables, and for biting fly control. Most air blast sprayers can be adapted to apply either high or low volumes of spray.

Advantages:

- good coverage and penetration, on some crops,
- low pump pressures, and
- mechanical agitation

Limitations:

- drift hazards,
- chance of overdosages,
- difficult to use in small areas, and
- hard to confine discharge to limited target areas.

Ultra-Low-Volume (ULV) Sprayers

These sprayers deliver undiluted pesticide from the air, on the ground, or in buildings.

Advantages:

- no water is needed, and
- equal control with less pesticide.

Limitations:

- does not provide for thorough wetting,
- hazards of using high concentrates,
- chance of overdosages, and
- limited number of pesticides that can be used this way.

Sprayer Parts

Tanks: Tanks should have large openings for easy filling and cleaning. They should allow straining during filling and have mechanical or hydraulic agitation. The tank should be made of corrosion-resistant material such as stainless steel or glass-reinforced plastic. If made of mild steel, it should have a protective plastic lining or coating. The tank should have a good drain. The outlets should be sized to the pump capacity. If you use dual tanks, make sure the plumbing allows for agitation and adequate withdrawal rates in both tanks. All tanks should have a gauge to show the liquid level.

Flush out the tank, pump, lines and nozzles after each day's use and each separate pesticide use. If switching to another pesticide where contamination must be prevented, wash out with detergent and water two or three times and then flush with water. Phenoxy herbicides such as 2,4-D are hard to remove. After using them, either follow the special cleaning procedures noted on the pesticide label or avoid using the same sprayer for any other product. Keep tank clean inside and out. Tighten or repair all leaky tank seals or fittings. Make sure sight gages can be read.

Pumps: The pump must be adequate for all the spraying pressures you use. It must provide enough flow to:

- supply all nozzles,
- allow for hydraulic agitation when needed, and
- leave a reserve to allow for loss of flow due to wear.

Pumps should resist corrosion and abrasion. Centrifugal pumps provide high volume at low pressure. They are not self-priming. Piston and diaphragm pumps provide moderate to high volumes at high pressure. They are self-priming. Roller and gear pumps provide moderate volume at low to moderate pressure. They are self-priming in most equipment. Do not use wettable powder formulations in gear pumps. If you need pressures above 75 psi, piston pumps are more likely to provide them over a long period of time.

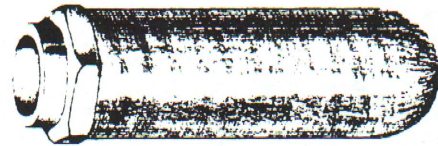
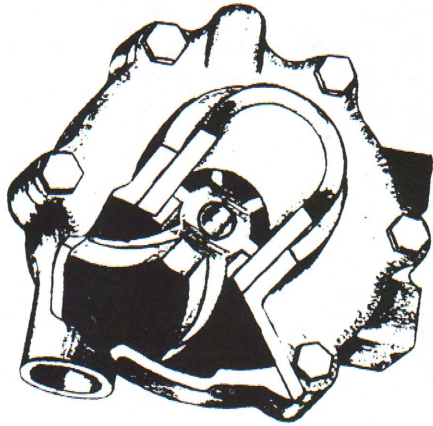

Strainers (filters): Proper filtering of the pesticide:

- protects the working parts of the sprayer, and
- avoids time loss and misapplication due to clogged nozzle tips.

Filtering should be progressive, with the largest mesh screen in the suction line between the tank and the pump. Put a smaller mesh screen in the high pressure line between the pump and the pressure regulator. Put the finest mesh screen nearest the nozzles. Do not use a screen in the suction line of a centrifugal pump.

Clean strainers after each use. Replace them if you see deterioration. Strainers are your best defense against nozzle and pump wear and nozzle clogging. Use nozzle screens as large as nozzle sizes permit. Screen openings should be less than nozzle openings.

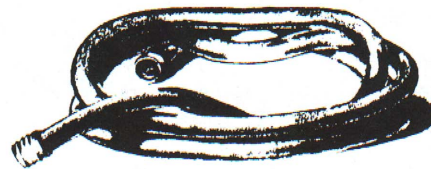
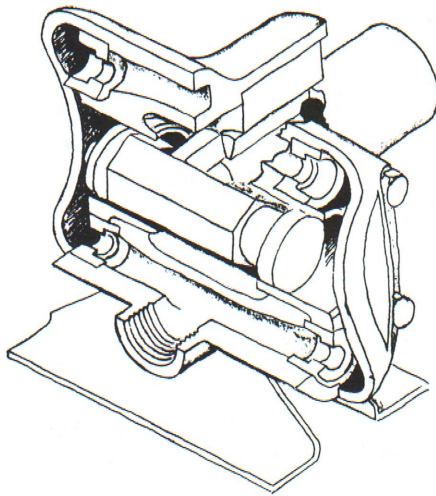

Hoses: Select synthetic rubber or plastic hoses that:

- have burst strength greater than the peak operating pressures,
- resist oil and solvents present in pesticides, and
- are weather-resistant.

Suction hoses should resist collapse. They should be larger than pressure hoses. All fittings on suction lines should be as large as or larger than the line itself.

Keep hoses from kinking or being rubbed. Rinse them often, inside and outside, to prolong life. Remove and store hoses during off season, or at least store unit out of sun. Replace hoses at the first sign of surface deterioration.

Pressure gages: These serve as the monitor of your spraying job. They must be accurate and have only the range needed for your work. For example, a 0-60 psi gage with 2-pound gradations would be enough for most low pressure sprayers.

You will damage a pump if you operate it dry or with a restricted inlet. Follow the manufacturer's recommendations for pump operation. Keep all shields in place.

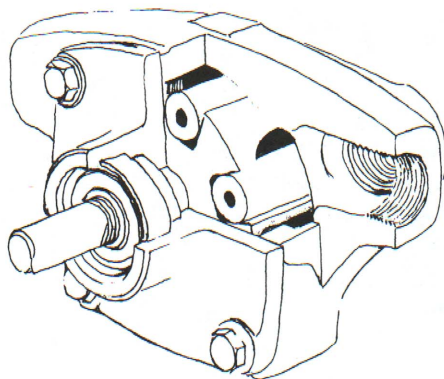

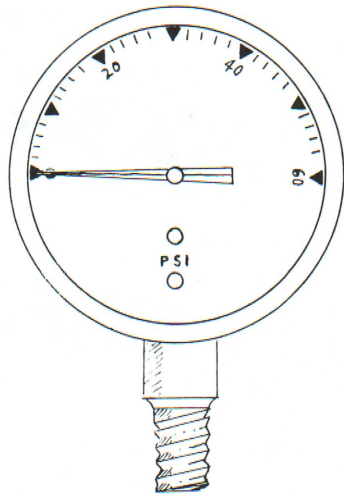

Check frequently for accuracy against an accurate gage. Do not use them under too much pressure. Keep glass faces clean and intact. Use gage protectors to protect against corrosive pesticides and pressure surges.

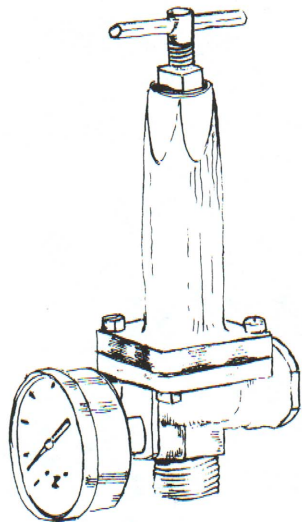

Pressure regulators: The pressure regulator must have a working range that is about the same as the range of pressure you plan to use.

Agitators: Make sure your sprayer has enough agitation. If it does not, your pesticide application rate may vary greatly as the tank is emptied. Bypass agitation may be good enough for solutions and emulsions. Use a jet agitator or mechanical agitator for wettable powders. Mechanical agitation

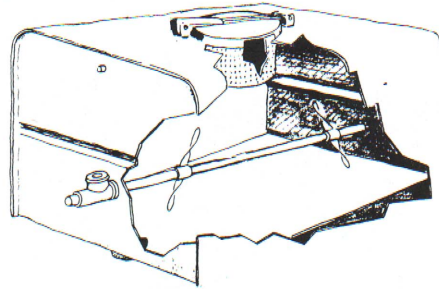

is the surest way to get good agitation; however, a mechanical agitator is expensive initially and harder to maintain. Hand sprayers must be shaken frequently.

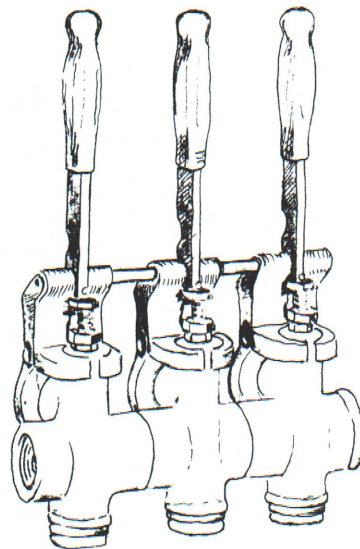

Control valves: These should be large enough so as not to restrict flow. They should be easy for you to reach. On-off action should be quick and positive. You need to be able to cut off all flow or flow to any section of the spraying system. There are many different kinds of control valves. Be sure you know how to operate and maintain the ones on your equipment.

Nozzles: The nozzle helps control the rate and pattern of distribution. Specifically, the rate and pattern of distribution depend on:

- the nozzle design or type,
- its operating pressure,
- the size of the opening,
- its discharge angle, and
- its distance from the target.

There are six basic nozzle types.



1. *Solid stream* is a type used in handguns to spray a distant target. It is also used in a nozzle body to apply pesticides in a narrow band or inject them into the soil.

2. *Flat fan*. There are three types of flat fan nozzles:

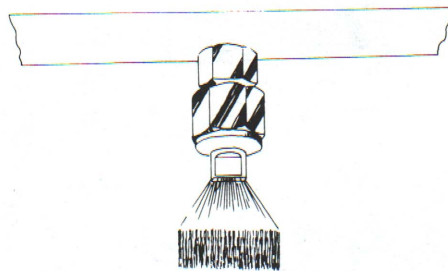

b. The even flat fan nozzle makes a uniform pattern across its width. It is used for band spraying and for treating walls and other surfaces.



c. The flooding nozzle makes a wide-angle flat spray pattern. It works at lower pressures than the other flat fan nozzles. Its pattern is fairly uniform across its width. It is used for broadcast spraying.

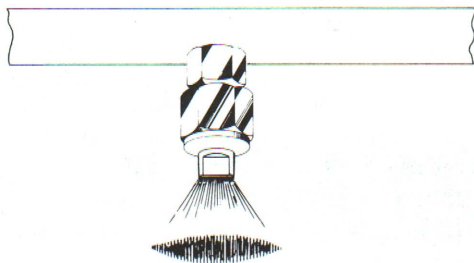

a. The regular flat fan nozzle makes a narrow oval pattern with lighter edges. It is used for broadcast spraying. This pattern is designed to be used on a boom and to be overlapped 30-50 percent for even distribution.

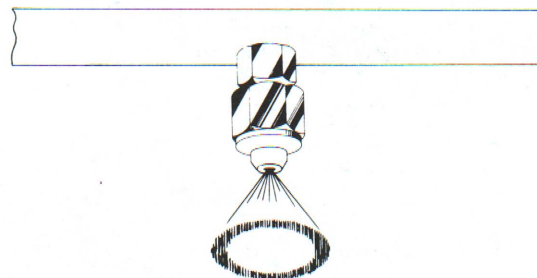

3. *Hollow cone*. There are two types of hollow cone nozzles:

- a. the core and disk, and
- b. the whirl chamber.

The pattern is circular with tapered edges and little or no spray in the center. It is used for spraying foliage.

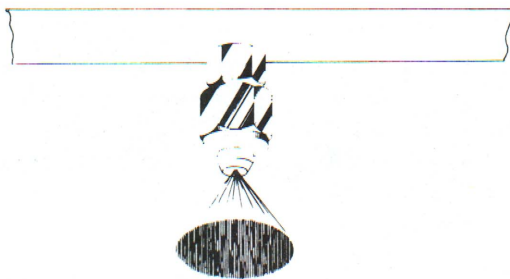

4. *Solid cone* nozzle produces a circular pattern. The spray is well distributed throughout the pattern. It is used for spraying foliage.
5. *Atomizing* nozzle makes a fine mist from liquid pesticides. Used indoors in special situations.

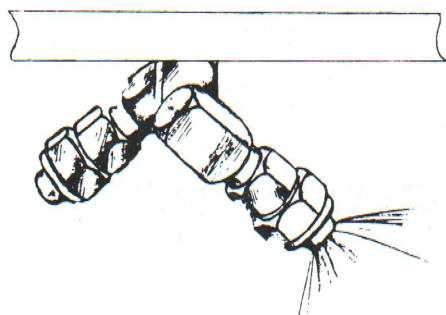

6. *Broadcast* nozzle forms a wide flat fan pattern. It is used on boomless sprayers and to extend the effective swath width when attached to the end of a boom.

Many spraying jobs can be done by more than one nozzle type or pattern. Here are some general guidelines.

For weed control:

- regular flat fan,
- flooding fan,
- even flat fan,
- hollow cone.

For disease control:

- hollow cone,
- solid cone.

For insect control outdoors:

- regular flat fan,
- hollow cone,
- solid cone.

For insect control indoors:

- even flat fan,
- solid stream,
- atomizing.

To minimize drift:

- flooding fan,
- whirl chamber hollow cone,
- keep operating pressures below 30 psi.

You can get nozzles in many materials. Here are the main features of each kind.

Brass:

- inexpensive,
- wears quickly from abrasion,
- probably the best material for limited use.

Stainless steel:

- will not corrode,
- resists abrasion, especially if it is hardened.

Plastic:

- resists corrosion and abrasion,
- swells when exposed to some solvents.

Aluminum:

- resists some corrosive materials,
- is easily corroded by some fertilizers.

Tungsten carbide and ceramic:

- highly resistant to abrasion and corrosion,
- expensive.

Keep nozzles in good working condition. For most boom applications, select nozzles of uniform type and size.

Nozzle caps should not be over-tightened. Adjust nozzle distance and spacing to suit the target. Follow the nozzle manufacturer's instructions and the pesticide label. Allow for crop or weed height if necessary. Check each nozzle for uniform flow using water and a jar marked in ounces. Replace any whose flow is 5 percent more or less than the average. Replace any nozzles having faulty spray patterns. A good check is to spray on asphalt pavement. Watch for streaks as you increase speed or as spray dries.

Clean nozzles only with a toothbrush or wooden toothpick.

Operation and Maintenance

Always read and follow the operators' manuals for all your spray equipment. They will tell you exactly how to use and care for it. After each use, rinse out the entire system. Remove and clean nozzles, nozzle screens and strainers. Check for leaks in lines, valves, seals and tank both after filling with water and during running.

Be alert for nozzle clogging and changes in nozzle patterns. If nozzles clog or other trouble occurs in the field, be careful not to contaminate yourself

while correcting the problem. Shut off the sprayer and move it to the edge of the field before dismounting. Wear protective clothing while making repairs.

Store sprayers correctly after use. But first, rinse and clean the system. Then fill tank almost full with clean water. Add a small amount of new light oil to the tank. Coat the system by pumping tank contents out through nozzles or handgun. Drain the pump and plug its openings or fill the pump with light oil or antifreeze. Remove nozzles and nozzle screens and store in light oil or diesel fuel.

DUSTERS AND GRANULAR APPLICATORS

Hand Dusters



Like hand sprayers, hand dusters are for use in structures such as greenhouses. They may consist of a squeeze bulb, bellows, tub, or shaker, a sliding tube, or a fan powered by a hand crank.

Advantages:

- the pesticide is ready to apply, and
- good penetration in confined spaces.

Limitations:

- high cost for pesticide,
- hard to get good foliar coverage, and
- dust is subject to drifting.

Power Dusters

Power dusters use a powered fan or blower to propel the dust to the target. They range from knapsack or backpack types to those mounted on or pulled by tractors. Their capacity in area treated per hour compares favorably with some sprayers.

Advantages:

- simply built,
- easy to maintain, and
- low in cost.

Limitations:

- drift hazards,
- high cost of pesticide, and
- application may be less uniform than with sprays.

Selecting a Duster

Look for a power duster that is easy to clean. It should give a uniform application rate as the hopper is emptied. Look for both hand and power dusters that keep the dust cloud well away from the user.

Granular Applicators

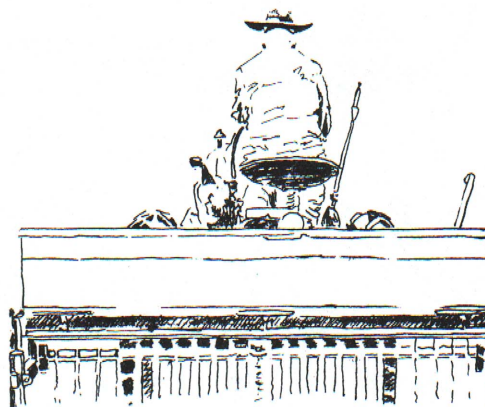

These include: (a) hand-carried knapsack and spinning disk types for broadcast coverage, (b) mounted equipment for applying bands over the row in row crops and vegetables, and (c) mounted or tractor-drawn machines for broadcast coverage.

Advantages:

- eliminates mixing,
- is low in cost,
- minimizes drift, and
- is less hazardous to applicator.

Limitations:

- high cost for pesticide,
- limited use against some pests because granules won't stick to most plants,
- need to calibrate for each granular formulation, and
- poor lateral distribution, especially on side slopes.

Selecting a Granular Applicator

Choose a granular applicator that is easy to clean and fill. It should have mechanical agitation over the outlet holes. This will prevent bridging and keep flow rate constant. Application should stop when drive stops even if outlets are still open.

Use and Maintenance

Both dusters and granular applicators are speed-sensitive, so maintain uniform speed. Do not travel too fast for ground conditions. Bouncing equipment will cause the application rate to vary. Stay out of any dust cloud that may form.

Watch banders to see that band width stays the same. Small height changes due to changing soil conditions may cause rapid changes in band width.

Clean equipment as directed by the operator's manual.

FUMIGANT APPLICATORS

This equipment is of two types:

1. that needed to handle low-pressure fumigants, and
2. that needed to handle high-pressure fumigants which are kept in liquid form only by storage in pressure vessels.

The low-pressure fumigators are gravity or pump fed units. Most high-pressure units use the pressure generated by the fumigant or a compressed gas to force the fumigant into the soil or space being fumigated.

Selection

Choosing equipment to apply low-pressure fumigants is similar to choosing a low-pressure sprayer, but corrosion-resistant pumps, tanks, fittings, nozzles and lines are essential. High-pressure fumigators must be able to withstand the internal pressure created by the fumigant. Select equipment with pressure or flow regulators that assure constant delivery rates.

Use and Maintenance

Keep the units in good repair. Make sure there are no leaks. Replace hoses and fittings as soon as you see signs of deterioration. Lines and fittings should not be located near the operator. Empty all lines after application. To avoid contamination and corrosion, flush the units after use. Carefully follow all precautions on the fumigant label.

AEROSOL GENERATORS AND FOGGERS

Aerosol generators work by using: (a) atomizing nozzles, (b) spinning disks, and (c) small nozzles at high pressure. Fogs are usually generated by thermal generators using heated surfaces.

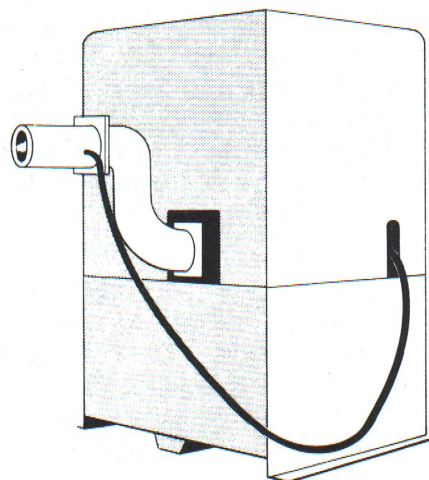

Advantages:

- efficient distribution of liquid pesticides in enclosed spaces,
- efficient distribution of liquid pesticides in dense foliage, and
- some devices automatic in operation.

Limitations:

- aerosols and fogs extremely sensitive to drift, and
- repeated application needed to maintain effectiveness.

Selection

Choose an aerosol generator according to where you will use it — indoors or outdoors. Aerosol and fog generators are manufactured for many special uses. Truck- and trailer-mounted machines are for use outdoors. Most hand-operated or permanently mounted automatic machines are for use indoors.

Use and Maintenance

In general, use and care for an aerosol generator as you would a sprayer. They do require special precautions. Be sure that the pesticides used in them are registered for such use. Keep them on the target. Because of the effects of weather conditions during applications, follow special use instructions. The operator, other humans, and animals must be kept out of the fog or smoke cloud.

CALIBRATION

Calibration means adjusting your equipment to apply the desired rate of pesticide. You need to do this so that you can be sure you are using each pesticide as directed on the label. Too much pesticide is dangerous; too little will not do a good job. Only by calibrating correctly can you safely get the best results.

There are many ways to calibrate equipment. The preferred methods differ according to the kind of equipment you use. Your county Extension agricultural agent can show you how to calibrate your equipment. There is one basic method for sprayers and another for dusters and granular applicators.

Sprayers

To apply a pesticide evenly and accurately, your sprayer must move at a constant speed. It also must operate at a constant pressure. Each nozzle must be clean and at the right height. All nozzles must be of the correct type and size for the job. Each nozzle in the system must deliver its rated amount of pesticide.

First, choose the speed, pumping pressure, and nozzle or nozzles that you want to use. Fill the spray tank with water and operate the sprayer in place to fill the plumbing. Top off the tank and spray a measured area as if you were applying the pesticide. Measure the amount of water needed to refill your tank. This is the application rate per unit of area. If it takes 8 gallons to refill the tank after spraying one acre, you are spraying at the rate of 8 gallons per acre. If your sprayer has a tank of more than 100 gallons capacity, you should spray an area large enough to use at least 10 percent of the tank capacity.

If your sprayer is delivering more or less spray than the label directs, you can change the rate three ways:

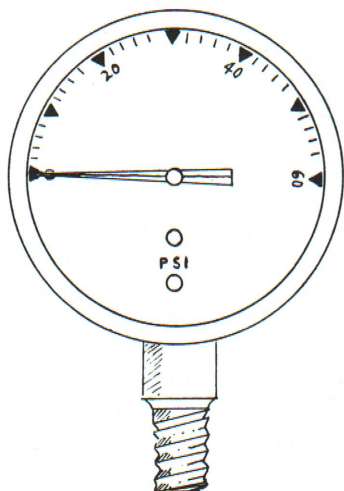

1. You can change the pressure. Lower pressure means less spray delivered; higher pressure means more spray delivered. This is not a good method, because a pressure change may change the nozzle pattern and droplet size. Pressure must be increased four times to double the output.

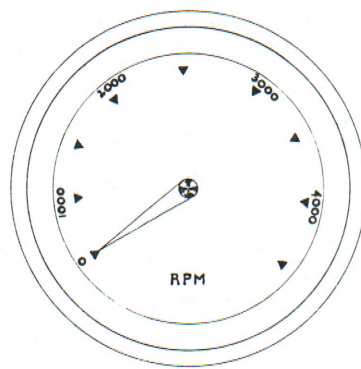

2. You can change the speed of your sprayer. Slower speed means more spray delivered, faster speed means less spray delivered. This method is practical for small changes in delivery rate. If you drive half as fast, you double the delivery rate.

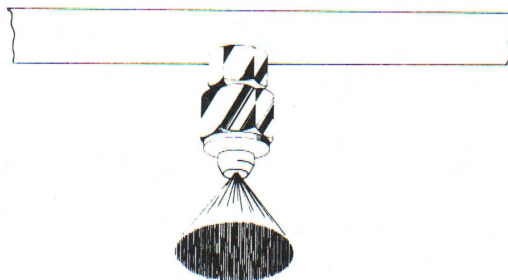

3. You can change the nozzle tips to change the amount delivered. The larger the hole in the tip, the more spray delivered. This is the best method for making major changes in the delivery rate of sprayers. Always select nozzles for the job you want done. Use the manufacturer's performance charts to make your selection.

After making a change, you must recalibrate your sprayer to make sure the rate is correct.

You have adjusted your sprayer and you know how many gallons of spray per unit of area your equipment will apply. Next you must find out how much pesticide to put in the tank to apply the correct dosage of pesticide. To do this you need to know two more facts:

- How much your sprayer tank holds.
- The amount of formulation to be used per unit of area. This will be given on the label.



Suppose your tank holds 50 gallons of spray. The directions say to apply one pint of formulation on each acre. In our example, you found that your sprayer applied 8 gallons per acre. First find the number of acres per tank load will spray. Divide 50 gallons by 8.

$$\frac{50 \text{ gallons per tankful}}{8 \text{ gallons per acre}} = 6\frac{1}{4} \text{ acres per tankful}$$

To find the amount of formulation you must add to your tank so you can spray $6\frac{1}{4}$ acres with one pint per acre, multiply 1 pint by $6\frac{1}{4}$.

$$1 \text{ pint per acre} \times 6\frac{1}{4} \text{ acres per tankful} = 6\frac{1}{4} \text{ pints per tankful.}$$

Suppose the formulation of a pesticide is a 50 percent wettable powder and you want to apply $\frac{1}{2}$ pound of active ingredient per acre. In our example your tank will cover $6\frac{1}{4}$ acres.

Find how many pounds of formulation are needed to apply $\frac{1}{2}$ pound of active ingredient per acre. There is $\frac{1}{2}$ pound of active ingredient in 1 pound of 50 percent wettable powder formulation. So you need to use 1 pound of formulation for each acre your sprayer will cover.

$$1 \text{ pound per acre} \times 6\frac{1}{4} \text{ acres per tankful} = 6\frac{1}{4} \text{ pounds per tankful.}$$

You should add the $6\frac{1}{4}$ pounds of wettable powder to a small amount of water in a clean bucket. Stir until it is mixed well and then add this mixture (called a *slurry*) to the partly filled tank. Remember to operate the sprayer's agitator while adding the slurry and filling the tank.

Even after your sprayer is calibrated, you should recheck it often. Be sure you are spraying the same size area for each tankful as you figured on. If you are spraying more or less acres than you planned, stop spraying and recalibrate. If you have figured wrong or your sprayer changes its delivery rate, you will be able to catch it before you make a major mistake.

Dusters and Granular Applicators

Read the manufacturer's operator's manual before using the equipment. Follow the instructions given to set the gate openings for the product you are going to use. **CAUTION:** always set the openings from the same directions, such as from closed to open. This will minimize variations in settings. After you have set the openings:

1. Fill each hopper to an easily determined level.
2. Operate the equipment over a measured area or distance at your normal working speed. The area should be large enough to use up one-fourth of the hopper contents.
3. Refill the hopper to the same level, weighing the amount of pesticide needed to replace what was used.
4. The amount of pesticide it takes to refill the hopper is the amount applied to the measured area. If the amount applied does not fall within 5 percent of the recommended dosage per unit of area, reset the gate openings and repeat steps 1 through 3.

Keep a record of the area treated with each filling of the hopper. This will let you see any slight change in rate of application and make the necessary adjustment.

Self-Help Questions on Section 9 – Application Equipment

Now that you have studied the section, answer these questions. Write the answers with pencil without referring back to the text. When you are satisfied with your written answers, see if they are correct by checking them in the text. Erase your answer and write in the correct answer if your first answer is wrong.

1. *Where can hand sprayers be used most effectively?*
2. *What are low-pressure field sprayers usually used for?*
3. *What are high-pressure (or hydraulic) sprayers usually used for?*
4. *Do air blast sprays produce large or small spray droplets?*
5. *Are there many pesticides available for use in ultra-low-volume sprayers?*
6. *Should there be a drain on a spray tank?*
7. *Where can you find recommendations for operation of a spray pump?*
8. *Why are strainers (filters) important in a sprayer?*
9. *Should the suction (intake) hose of a sprayer be larger or smaller than the pressure hoses?*
10. *How can you be sure that the pressure gauge of your sprayer is accurate?*
11. *Should your pressure regulator exceed the range of pressure that you plan to use?*
12. *Can wettable powder formulations be agitated effectively by bypass (return line) agitation?*
13. *How should control valves for a sprayer turn on and off?*
14. *What is a solid stream type spray nozzle especially good for?*
15. *Are regular flat fan nozzles intended to be overlapped for spraying?*
16. *What is an even flat fan nozzle used for?*

17. *Is a flooding nozzle designed to apply directed sprays?*
18. *Are both hollow cone and solid cone nozzles used to spray foliage?*
19. *Is the atomizing nozzle usually used to spray crops in the field?*
20. *How does a broadcast nozzle differ from a flooding nozzle?*
21. *What type of nozzles are recommended for control of diseases?*
22. *What is a problem with nozzles made of brass?*
23. *How would you determine the flow (output) of a nozzle?*
24. *How much variation between flows of nozzles on the same boom is considered tolerable?*
25. *What are two good tools to use to clean nozzles?*
26. *Where can you obtain information on the use and care of your spray equipment?*
27. *Should you make repairs to a sprayer in the center of the field?*
28. *Should nozzles and filters be left on the sprayer while not in use?*
29. *Can hand dusters be effectively used in greenhouses?*
30. *Is drift of the pesticide a limitation on the use of power dusters?*
31. *What safety feature for the operator is especially desirable in a power duster?*
32. *Is a mechanical agitator desirable in a granular applicator?*
33. *Is a granular applicator more or less hazardous to the operators than a power duster?*
34. *Will bouncing of dusters and granular applicators cause the application rate to vary?*
35. *Is a pump usually needed when a high-pressure fumigation unit is used?*
36. *What special characteristic should pumps, tanks, fittings, lines and nozzles of a low-pressure fumigant application unit have?*
37. *Where can you find precautions on the safe effective use of fumigants?*
38. *Are aerosol generators and foggers used to reduce hazard from drift of a pesticide?*

39. *Can aerosol generators be used for pest control indoors?*
40. *Do weather conditions affect the use of aerosol generators?*
41. *What does the term calibration mean with respect to pesticide application equipment?*
42. *What is a good method of determining the amount of spray delivered per acre with a sprayer?*
43. *Will a change to higher pressure raise or lower the amount of water applied by a sprayer?*
44. *If you decrease tractor speed while spraying, do you increase or decrease the amount of spray applied per acre?*
45. *Where can you find information on the size nozzle to be used to obtain the amount of spray that you wish to apply?*
46. *Your tank holds 150 gallons of water; you will apply 10 gallons of water per acre; you will apply 1 quart of pesticide per acre:*
a. How many acres can you spray with one tankful of water?
b. How many quarts of pesticide will you need to add to a tankful of water?
47. *If you are to apply 1 pound of active pesticide per acre, how much of a pesticide formulation will you need to add to the water required to spray one acre if:*
a. The formulation is an 80 percent wettable powder?
b. The formulation is an emulsifiable concentrate containing 2 pounds active pesticide per gallon? (The answer to this question is not presented in this section of the manual, but is important and is included here.)
48. *Should you thoroughly mix a wettable powder with water in a bucket to make a slurry before adding the wettable powder to the spray tank?*
49. *How can you recheck the calibration of your sprayer as you are spraying the field?*
50. *Where can you find information on how to set a duster or granular applicator to obtain the flow of pesticide that you want?*
51. *What is a good method for determining the amount of dust or granules that you will apply per acre?*
52. *How can you recheck the calibration of your duster or granular applicator as you are applying the pesticide in the field?*

Other Terms Used in Pest Control

Some of these words have several meanings. Those given here are the ones that relate to pest control.

Abrasion: The process of wearing away by rubbing.

Abscission: The separation of fruit, leaves or stems from a plant.

Absorption: The process by which a chemical is taken into plants, animals or minerals. Compare with adsorption.

Activator: A chemical added to a pesticide to increase its activity.

Adherence: Sticking to a surface.

Adjuvant: Inert ingredient added to a pesticide formulation to make it work better.

Adsorption: The process by which chemicals are held on the surface of a mineral or soil particle. Compare with absorption.

Adulterated: Any pesticide whose strength or purity falls below the quality stated on its label. Also, a food, feed or product that contains illegal pesticide residues.

Aerobic: Living in air. The opposite of anaerobic.

Aerosol: An extremely fine mist of fog consisting of solid or liquid particles suspended in air. Also, certain formulations used to produce a fine mist.

Agitation: The process or stirring or mixing in a sprayer.

Alkaloids: Chemicals present in some plants. Some are used as pesticides.

Anaerobic: Living in the absence of air. The opposite of aerobic.

Animal sign: The evidence of an animal's presence in an area.

Antagonism: The loss of activity of a chemical when exposed to another chemical.

Antibiotic: A substance which is used to control pest microorganisms.

Antidote: A practical treatment for poisoning, including first aid.

Aqueous: A term used to indicate the presence of water in a solution.

Arsenicals: Pesticides containing arsenic.

Aseptic: Free of disease-causing organisms.

Bait shyness: The tendency for rodents, birds or other pests to avoid a poisoned bait.

Bipyridyliums: A group of synthetic organic pesticides which includes the herbicide paraquat.

Botanical pesticide: A pesticide made from plants. Also called a plant-derived pesticide.

Broadleaf weeds: Plants with broad, rounded, or flattened leaves.

Brush control: Control of woody plants.

Carbamate: A synthetic organic pesticide containing carbon, hydrogen, nitrogen and sulfur.

Carcinogenic: Can cause cancer.

Carrier: The inert liquid or solid material added to an active ingredient to prepare a pesticide formulation.

Causal organism: The organism (pathogen) that produces a specific disease.

Chemosterilant: A chemical that can prevent reproduction.

Chlorinated hydrocarbon: A synthetic organic pesticide that contains chlorine, carbon, and hydrogen. Same as organochlorine.

Chlorosis: The yellowing of a plant's green tissue.

Cholinesterase: A chemical catalyst (enzyme) found in animals that helps regulate the activity of nerve impulses.

Compatible: When two or more chemicals can be mixed without affecting each other's properties, they are said to be compatible.

Concentration: The amount of active ingredient in a given volume or weight of formulation.

Contaminate: To make impure or to pollute.

Corrosion: The process of wearing away by chemical means.

Crucifers: Plants belonging to the mustard family, such as mustard, cabbage, turnip and radish.

Cucurbits: Plants belonging to the gourd family, such as pumpkin, cucumber and squash.

Deciduous plants: Perennial plants that lose their leaves during the winter.

Deflocculating agent: A material added to a suspension to prevent settling.

Degradation: The process by which a chemical is reduced to a less complex form.

Dermal: Of the skin; through or by the skin.

Dermal toxicity: Ability of a chemical to cause injury when absorbed through the skin.

Diluent: Any liquid or solid material used to dilute or carry an active ingredient.

Dilute: To make thinner by adding water, another liquid or a solid.

Dispersing agent: A material that reduces the attraction between particles.

Dormant: State in which growth of seeds or other plant organs stops temporarily.

Dose, dosage: Quantity of a pesticide applied.

Emulsifier: A chemical which aids in suspending one liquid in another.

Emulsion: A mixture in which one liquid is suspended as tiny drops in another liquid, such as oil in water.

Fungistat: A chemical that keeps fungi from growing.

GPA: Gallons per acre.

GPM: Gallons per minute.

Growth stages of cereal crops: (1) tillering — when additional shoots are developing from the flower buds; (2) jointing — when stem internodes begin elongating rapidly; (3) booting — when upper leaf sheath swells due to the growth of developing spike or panicle; (4) heading — when seed head is emerging from the upper leaf sheath.

Hard water: Water containing soluble salts of calcium and magnesium and sometimes iron.

Herbaceous plant: A plant that does not develop woody tissue.

Hydrogen-Ion concentration: A measure of acidity or alkalinity, expressed in terms of the pH of the solution. For example, a pH of 7 is neutral, from 1 to 7 is acid, and from 7 to 14 is alkaline.

Immune: Not susceptible to a disease or poison.

- Impermeable:** Cannot be penetrated. Semipermeable means that some substances can pass through and others cannot.
- Incompatible:** When two or more chemicals in a mixture affect each other's properties, they are said to be incompatible.
- Lactation:** The production of milk by an animal, or the period during which an animal is producing milk.
- LC₅₀:** The concentration of an active ingredient in air which is expected to cause death in 50 percent of the test animals so treated. A means of expressing the toxicity of a compound present in air as dust, mist, gas or vapor. It is generally expressed as micrograms per liter as a dust or mist but in the case of a gas or vapor as parts per million (ppm).
- LD₅₀:** The dose of an active ingredient taken by mouth or absorbed by the skin which is expected to cause death in 50 percent of the test animals so treated. If a chemical has an LD₅₀ of 10 milligrams per kilogram (mg/kg) it is more toxic than one having an LD₅₀ of 100 mg/kg.
- Leaching:** Movement of a substance downward or out of the soil as the result of water movement.
- Mammals:** Warm-blooded animals that nourish their young with milk. Their skin is more or less covered with hair.
- Miscible liquids:** Two or more liquids that can be mixed and will remain mixed under normal conditions.
- MPH:** Miles per hour.
- Mutagenic:** Can produce genetic change.
- Necrosis:** Localized death of living tissue such as the death of a certain area of a leaf.
- Necrotic:** Showing varying degrees of dead areas or spots.
- Nitrophenols:** Synthetic organic pesticides containing carbon, hydrogen, nitrogen and oxygen.
- Noxious weed:** A plant defined as being especially undesirable or troublesome.
- Oral:** Of the mouth; through or by the mouth.
- Oral toxicity:** Ability of a pesticide to cause injury when taken by mouth.
- Organic compounds:** Chemicals that contain carbon.
- Organochlorine:** Same as chlorinated hydrocarbon.
- Organophosphate:** A synthetic organic pesticide containing carbon, hydrogen and phosphorus; parathion and malathion are two examples.
- Ovicide:** A chemical that destroys eggs.
- Parasite (or parasitoid):** An animal, usually smaller than its host, which feeds in or on another animal.
- Pathogen:** Any disease-producing organism.
- Penetration:** The act of entering or ability to enter.
- Phytotoxic:** Harmful to plants.
- Pollutant:** An agent or chemical that makes something impure or dirty.
- PPB:** Parts per billion. A way to express the concentration of chemicals in foods, plants, and animals. One part per billion equals 1 pound in 500,000 tons.
- PPM:** Parts per million. A way to express the concentration of chemicals in foods, plants, and animals. One part per million equals 1 pound in 500 tons.
- Predator:** An animal that destroys or eats other animals.
- Propellant:** Liquid in self-pressurized pesticide products that forces the active ingredient from the container.
- PSI:** Pounds per square inch.
- Pubescent:** Having hairy leaves or stems.
- RPM:** Revolutions per minute.
- Safener:** A chemical added to a pesticide to keep it from injuring plants.
- Seed protectant:** A chemical applied to seed before planting to protect seeds and new seedlings from disease and insects.
- Soil sterilant:** A chemical that prevents the growth of all plants and animals in the soil. Soil sterilization may be temporary or permanent, depending on the chemical.
- Soluble:** Will dissolve in a liquid.
- Solution:** Mixture of one or more substances in another in which all ingredients are completely dissolved.
- Solvent:** A liquid which will dissolve a substance to form a solution.
- Spreader:** A chemical which increases the area that a given volume of liquid will cover on a solid or on another liquid.
- Sticker:** A material added to a pesticide to increase its adherence.
- Surfactant:** A chemical which increases the emulsifying, dispersing, spreading and wetting properties of a pesticide product.
- Susceptible:** Capable of being diseased or poisoned; not immune.
- Susceptible species:** A plant or animal that is poisoned by moderate amounts of a pesticide.
- Suspension:** Finely divided solid particles mixed in a liquid.
- Synergism:** The joint action of two or more pesticides that is greater than the sum of their activity when used alone.
- Tank mix:** The addition of two or more separate pesticide formulations in the same container for application at the same time.
- Target pest:** The pest at which a particular pesticide or other control method is directed.
- Tolerance:** (1) The ability of a living thing to withstand adverse conditions such as pest attacks, weather extremes, or pesticides. (2) The amount of pesticide that may safely remain in or on raw farm products at time of sale.
- Toxicant:** A poisonous chemical.
- Trade name:** Same as brand name.
- Vapor pressure:** The property which causes a chemical to evaporate. The lower the vapor pressure, the more easily it will evaporate.
- Vector:** A carrier, such as an insect, that transmits a pathogen.
- Viscosity:** A property of liquids that determines whether they flow readily. Viscosity usually decreases when temperature decreases.
- Volatile:** Evaporates at ordinary temperatures when exposed to air.
- Wetting agent:** A chemical which causes a liquid to contact surface areas more thoroughly.